

**Provided for non-commercial research and educational use only.
Not for reproduction, distribution or commercial use.**

This chapter was originally published in the book *Advances in Marine Biology – Biology of Northern Krill - 57*, published by Elsevier, and the attached copy is provided by Elsevier for the author's benefit and for the benefit of the author's institution, for non-commercial research and educational use including without limitation use in instruction at your institution, sending it to specific colleagues who know you, and providing a copy to your institution's administrator.

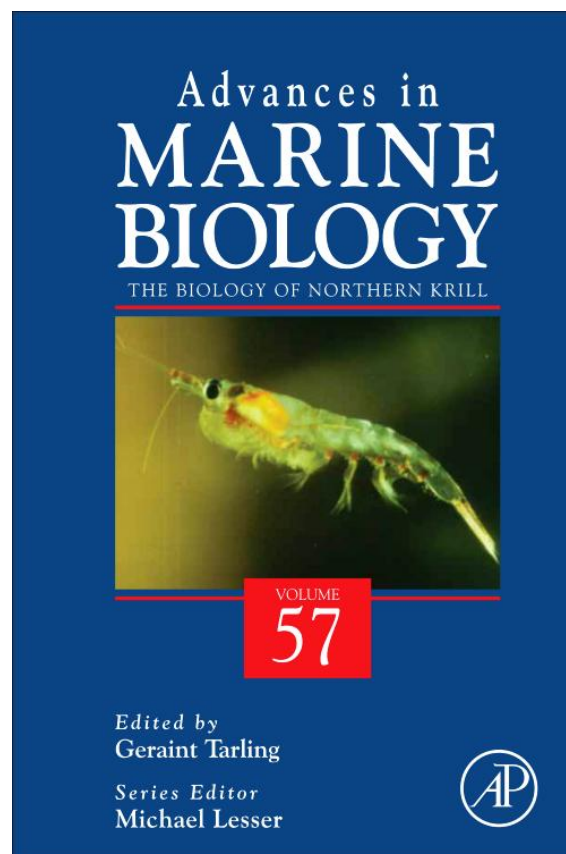

All other uses, reproduction and distribution, including without limitation commercial reprints, selling or licensing copies or access, or posting on open internet sites, your personal or institution's website or repository, are prohibited. For exceptions, permission may be sought for such use through Elsevier's permissions site at:

<http://www.elsevier.com/locate/permissionusematerial>

From: Friedrich Buchholz and Cornelia Buchholz, Growth and Moulting in Northern Krill (*Meganyctiphanes norvegica* Sars). In GERAINT A. TARLING editor: *Advances in Marine Biology – Biology of Northern Krill - 57*, Burlington: Academic Press, 2010, pp. 173-197. ISBN: 978-0-12-381308-4
© Copyright 2010 Elsevier Inc. Academic Press.

GROWTH AND MOULTING IN NORTHERN KRILL (*MEGANYCTIPHANES NORVEGICA* SARS)

Friedrich Buchholz *and* Cornelia Buchholz

Contents

1. Introduction: Linking Moulting and Growth	174
2. The Basic Course of the Moulting Cycle	175
2.1. Hormonal and environmental control	177
2.2. Categorisation and timing of stages in the moulting cycle	178
2.3. Timing of IMP and the dimension of INC	181
2.4. Coordination of moulting and reproductive cycles	183
2.5. Growth versus reproduction	184
3. Practical Approaches	186
3.1. Laboratory maintenance and catch of specimens	186
3.2. Moulting staging	187
3.3. Field assessment of IMP and moulting activity	188
4. Growth in the Field Along a Climatic Gradient	190
4.1. Seasonal timing, synchronisation and autonomy of moulting	190
4.2. Life-growth assessments	191
5. An Outlook: Growth, Productivity and Environmental Change	193
Acknowledgements	194
References	194

Abstract

Moulting and growth as a key aspect of the life-history of crustaceans has been reviewed here for *Meganyctiphanes norvegica*. Moulting is a cyclical process with relatively constrained, uniform phases that have been well documented. The crustacean moulting cycle has a large influence on growth-rates, reproduction and metabolism. Moulting and growth are under hormonal control with further environmental influences. A pre-requisite for intensive studies is a detailed moulting staging system. Here, a further refinement and temporal phasing is presented for *M. norvegica*. On such a basis, the dynamics of cuticle synthesis and degradation are shown. Moulting and reproductive cycles are interlinked and krill is able to combine

Alfred Wegener Institute for Polar and Marine Research, Bremerhaven, Germany

Advances in Marine Biology, Volume 57
ISSN 0065-2881, DOI: 10.1016/S0065-2881(10)57006-8

© 2010 Elsevier Ltd.
All rights reserved.

growth and reproduction in a way that allows females to achieve similar net growth rates to males. A synchronisation of physiological processes and behaviour related to growth and reproduction enhances environmental success. Moulting staging can also be used to assess growth rates in the field. Some further technical approaches are reviewed. Laboratory maintenance and field data are combined to determine growth rates under various environmental conditions. These are related to life-growth assessments from population studies comparing krill along a latitudinal gradient. Life-cycle and physiological data indicate that Northern krill are able to cope with both warm and cold environments and have highly adaptable phenotypes. The species may serve as useful indicator of environmental change. Its potential proliferation in new environments may also have implications to regional food webs, given the krill's high level of growth and productivity and their pivotal trophic role.

1. INTRODUCTION: LINKING MOULT AND GROWTH

Crustacean growth depends on a series of moults, exchanging the rigid exoskeleton for a larger or differently equipped one, a property shared with all arthropods. At a superficial level, growth in crustaceans occurs discontinuously given the saltatory nature of an abrupt growth increment at each ecdysis. It can be characterised by two parameters: the intermoult period (IMP) and the growth increment at moult (INC).

In fact, moulting is a continuous process where one moult cycle is immediately linked to the next under favourable trophic and environmental conditions. As soon as the new exoskeleton is completed the water, which has been taken up to burst-open the old shell at predetermined seams and extend the new shell, is replaced continuously by tissue and lipid stores. Apolysis, the retraction of the epidermis from the exoskeleton during the premoult phase, is the first sign of preparation for the next moult. The epidermis then starts to build new exoskeletal layers until water is pumped in to initiate ecdysis and define the size of the next growth increment.

These processes are controlled by hormones which determine the timing of the moult rhythm and are the functional interface to environmental signals, such as temperature, photoperiod and trophic input.

In insects, the last metamorphic moult is the one which determines the final size of the individual. In some crustacean species, an analogous terminal anecdyosis prevails where the moulting gland that produces the indispensable moult hormone simply degenerates. However, crustacean growth is mostly indeterminate—leading to, for example giant lobsters. Moulting is cyclical and relatively uniform in its phases, and much study has been devoted to determining the constraints on these moult phases. In turn, the moult cycle has a large influence on other rates, such as growth, reproduction and physiology and so is a key aspect of the life-history of crustaceans.

2. THE BASIC COURSE OF THE MOULT CYCLE

The organic matrix of the crustacean cuticle is a complex structure composed mainly of α -chitin microfibrils embedded in a protein matrix. These are mainly stacked in chitin/protein lamellae, called laminae. Morphologically, there are three different layers in the cuticle of krill: an outermost epicuticle followed by an exocuticle and an endocuticle (Fig. 6.1A; Buchholz and Buchholz, 1989; Buchholz *et al.*, 1989). The epicuticle is the only layer to contain glycoproteins in addition to the chitin/protein matrix but makes up only 1.6% of total cuticular thickness. The exocuticle makes up 20% of the cuticle. Both the epi- and exocuticle are deposited before the krill sheds its old shell in the moult. The remainder of the cuticle is endocuticle, which is quickly built up in the postmoult period. The epidermis lies beneath these layers and is responsible for forming the new cuticle and secreting enzymes that digest the old one. Cell processes of the epidermis travel through pore canals in the new cuticle to reabsorb digested old cuticle components (Buchholz and Buchholz,

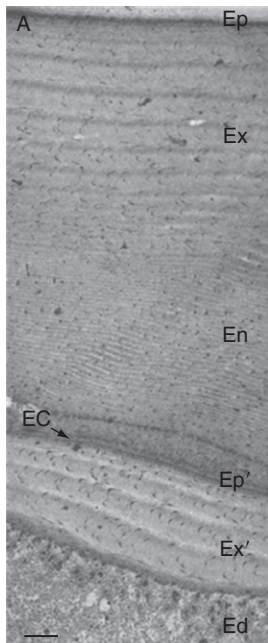

Figure 6.1 (A) Ultrastructure of the fully developed krill cuticle (*Meganyctiphanes norvegica*) at moult stage D2 with new epi- (Ep') and exocuticle (Ex') present underneath the old one. Ep epicuticle, Ex exocuticle, En endocuticle, EC exuvial cleft with the proximal layers of the endocuticle partly dissolved, Ed epidermis ('tendinal' cell). Scale bar 1 μm .

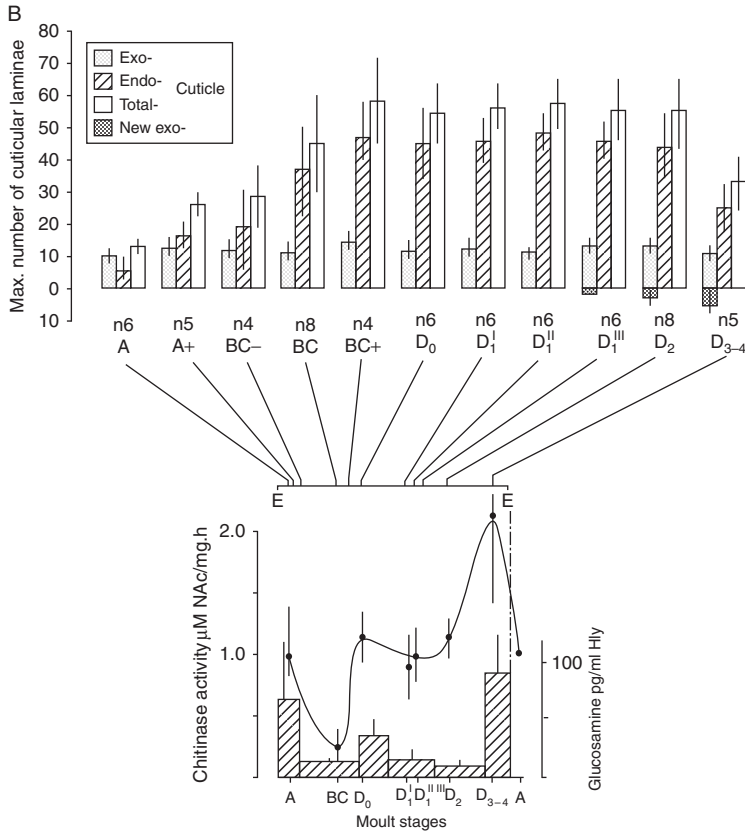

Figure 6.1 (B) *Euphausia superba*. Means and standard deviations of the max. cuticular laminae counted in the sixth pleomer at detailed moult stages. The lower part of the diagram depicts chitinase activity in the integument and *N*-acetyl- β -*D*-glucosamine content in the haemolymph (Hly) during the moult cycle (graph from Buchholz and Buchholz, 1989, with permission).

1989). The dynamic aspect of moult related cuticle build-up and breakdown is illustrated in Fig. 6.1B showing increases and decreases in the number of cuticle laminae (note formation of the new endocuticle during late premoult). High activity of the chitinase coincides with elevated levels of glucosamine in the haemolymph indicating re-absorption of the amino-sugars from the cuticle. The early mobilisation of such energy rich components through chitinolysis at apolysis (stage D₀) was recently confirmed by gene expression studies (Tarling, personal communication).

2.1. Hormonal and environmental control

The uniformity of the adult moult cycle allows the definition of finely graded moult stages (see below). The physiological relevance of such stages was first established by [Adelung \(1971\)](#) in the green crab, *Carcinus maenas* by determining the temporal course of the titre of the moult hormone 20-OH-ecdysone in the haemolymph over a complete moult cycle. This general pattern of moult stages is still valid today throughout most crustacean taxa ([Covi et al., 2009](#)). Typically, directly after an ecdysis, an elevated level of 20-OH-ecdysone is still present declining to minimum levels during the postmoult phase. With apolysis, 20-OH-ecdysone concentration rises steeply, reaches a maximum a few days before the moult and falls abruptly again, well before ecdysis, to the low postmoult level. In *Euphausia superba*, this typical pattern was also found, but with a separate peak coinciding with apolysis ([Buchholz, 1991](#)).

The steroid moult hormone is produced in the thoracical moulting gland, the Y-organ, and is itself controlled by the moult inhibiting hormone MIH which is secreted by the X-organ. The X-organ-sinus-gland complex is a typical neuro-haemal organ located in the eye stalks, where a series of neuropeptides is produced, including some moult stimulating factors, which are shed into the haemolymph. The mode of action is apparently dependent on a reverse titre of MIH and ecdysone ([Nakatsuji et al., 2009](#)). Specific steroid levels control protein and lipid synthesis in relation to complex developmental and internal growth processes. Organ specificity is achieved by receptors on cells and secondary messengers within the cells. In addition, ecdysones serve other functions in the control of reproduction and embryogenesis ([Subramoniam, 2000](#)).

The ecdysone titre controls the course of the regular moult cycle. Environmental cues modify the cycle via hormonal action, most possibly through variation of the MIH ([Nakatsuji et al., 2009](#)): crabs can halt ongoing moult processes when predators are present ([Adelung, 1971](#)) and low ecdysone levels are associated with diapause in copepods ([Johnson, 2003](#)). The seasonal intensity of metabolic functions in Antarctic krill appear to be controlled by the photoperiod ([Teschke et al., 2008](#)) and a light signal may also trigger apolysis, to set off the next pre-moult phase ([Seear et al., 2009](#)). The MIH-ecdysone system is probably the mediator, adjusting the timing of seasonal development and growth.

The complex suite of processes directly linked to the shedding of the shell is triggered by the pre-moult peak and thereafter runs independently from ecdysone control, following a fixed temporal schedule in, for instance, final resorption of the old cuticle, water uptake, ecdysis and the consolidation and hardening of the new shell ([Fig. 6.1B](#); [Buchholz et al., 1989](#)). This process takes a fixed amount of time in the moult cycle and can be used to assess its overall duration in krill swarms in field studies (see below).

2.2. Categorisation and timing of stages in the moult cycle

The moult cycle can be divided into two main phases of postmoult and premoult. As a rough guide, 30% of the cycle is spent in the postmoult stage and the remainder is divided evenly between early and late premoult. The moult cycle is nevertheless comprised of a large number of incremental stages that can be distinguished morphologically or histologically. The definitive reference in this regard was published by [Drach \(1939\)](#) for crab and shrimp but has been found applicable and valid for a wide range of crustacean taxa since. Accordingly, it has been the most widely applied system until today and it is wise to use Drach's nomenclature of moult stages as a permanent reference. It was adopted for Antarctic krill by [Buchholz \(1982\)](#) and extended to include moult stage durations in [Buchholz \(1991\)](#). [Cuzin-Roudy and Buchholz \(1999\)](#) adapted the scheme for *Meganyctiphanes norvegica*. [Table 6.1](#) is an overview of the main phases based on [Buchholz \(1991\)](#) and applies to both *M. norvegica* and *E. superba*, including an update to the estimated duration of each of the moult stages in *M. norvegica* ([Buchholz et al., 2006](#)). The stage nomenclature was devised to match the Drach system as closely as possible, this applies also for the detailed version in [Table 6.2](#).

A difficulty with the above scheme is that it is a labour intensive system to apply at the population level and also demands that all specimens be handled fresh, which is often not possible in the field. Therefore, other schemes of moult-stage categorisation have been devised which rely on features that are more readily distinguishable. For instance, [Tarling et al. \(1999a\)](#) considered the state of cuticle rigidity of specimens in freshly caught specimens over diurnal cycles to examine the interaction between moulting

Table 6.1 Overview table of moult phases, stages and updated durations in *Meganyctiphanes norvegica*

Phase	Process	Cuticle rigidity	Stage	Duration in % of moult cycle (previous value)	
Postmoult	Solidification of cuticle	Soft	A	2.0	(6.3)
		Hardening	B	7.4	(8.6)
	Reserve accumulation	Hard	C	21.1	(15.6)
Premoult	Secretion of new cuticle, setogenesis	Hard	D0	15.6	(15.6)
	New endocuticle	Hard	D1	23.4	(23.4)
	Cuticle resorption	Hard	D2	18.2	(19.5)
	Cuticle resorption	Soft	D3	12.7	(10.9)
Ecdysis	Actual moult		E	< 1	

The original moult stage durations (brackets) were first published in [Cuzin-Roudy and Buchholz \(1999, with permission\)](#).

Table 6.2 Moulst staging criteria for *Meganyctiphanes norvegica* (*M.n.*) with reference to *Euphausia superba* (*E.s.*; Buchholz, 1991, with permission)

Stage			% IMP
<i>M. n.</i>	<i>E.s.</i>	Description	<i>M.n.</i>
A	A–	Cuticle (Cut) very thin and soft, specimen is unsupported outside water (flaccid). Uropod tissue (Upt) not structured.	2.0
B_{early}	A	Cut: increasingly rigid. Upt: not structured. Contents of setae (Set.) is coarsely granular.	7.4
B	A+	Cut: increasingly rigid. Upt: stripe pattern starts to develop. Set: increasingly finely granular.	
C_{early}	BC–	Cut: still flexible at the rims of the carapace and lateral sclerites of abdomen. Upt: stripe pattern fully developed. Set: proximally still granular, otherwise clear.	21.1
C	BC	Cut: completely hard. Set: contents clear, no epidermal detachments.	
C_{late}	BC+	Epidermis (Epd) begins to retract at bases of setae.	
D₀	D ₀	Epd completely detached from cuticle: apolysis	15.6
D_{0 late}	D ₀ +	Epd begins to turn inside (invagination) at bases of setae.	
D_{1 early}	D ₁ '	Annular fold of Epd reaches to less than 1/3 of the length of the old setae into the Upt.	23.4
D₁	D ₁ ''	Fold of invagination has reached its farthest point.	
D_{1 late}	D ₁ '''	Secondary bristles start to form on Set. Epd still lacks a cuticle.	
D₂	D ₂	New cuticle is visible at bases to tips of setae and sec. bristles.	18.2
D_{2 late}	D ₂ +	Full thickness attained by new cuticle. Krill is ready for moult.	
D_{3 early}	D ₃₋₄ –	Krill starts to become soft shelled (like <i>C_{early}</i>)	12.7
D₃	D ₃₋₄	Cuticle completely softened	
D_{3 late}	D ₃₋₄ +	Specimen is unsupported outside water (flaccid). New cuticle detachable from old one by forceps.	
E	E	Ecdysis: krill moults within 10–20 s	

Our criteria and descriptions were cross-validated with J. Cuzin-Roudy (Villefranche-sur-Mer) through comparing categorisations of the same specimens.

and vertical migration behaviour. Specimens were categorised as ‘moulting’ when they were ‘flaccid’ (soft shelled and unsupported outside the water), corresponding to both moult stages A and D3, including the very short stage E of the actual ecdysis. Further moult stages were not differentiated in that study. Additional moult-time-series have been run on *M. norvegica* in the laboratory (at Marine Research Station Kristineberg, Gullmarsfjord in 1999 and 2000, Buchholz unpublished) and these new observations on moult-stage timings have now been integrated into the updated moult stage durations given here. Table 6.2 gives an extended version of the moult cycle for more practical application in the context of field and population studies on *M. norvegica*. Previous nomenclature used for *E. superba* is also included for comparison (Table 6.2; Buchholz, 1991).

Combining morphological moult staging (Fig. 6.2) with gene expression studies may give considerable further insights in the moult cycle of krill and

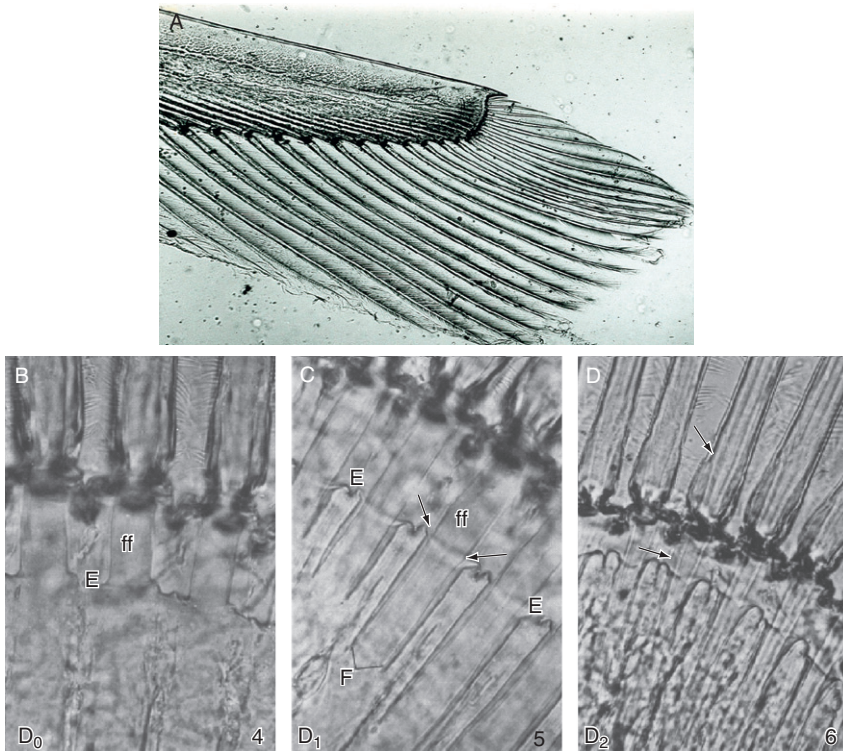

Figure 6.2 (A) Uropod of *Meganyctiphanes norvegica*, $\sim 200\times$; (B)–(D) tip of the uropod in *Euphausia superba* in different premoult stages, $\sim 400\times$. From Buchholz (1982), with permission; (B) Stage D0 = Apolysis, the epidermis (E) detaches from the cuticle; (C) Stage D1: Annular invaginations (arrows) start to form; (D) Stage D2: ready to moult specimen: cuticle doubled. The new seta bears a cuticle and secondary bristles (arrows).

other crustaceans, for example such as in the elucidation of chitin turnover- or cuticle-digestion processes (Seear *et al.*, 2009; Shechter *et al.*, 2007). In turn, the morphological stage definitions may be validated and refined further in this way (see also Fig.6.1B).

2.3. Timing of IMP and the dimension of INC

The interrelationship between IMP and INC depends on the exact timing of the moult phases. These, in turn, may be affected by environmental cues. In establishing any scheme on the physiological basis of growth, the adjustment of the moult cycle according to seasonal environmental signals must be considered.

IMP has been found to be invariably around 13 d in adult krill of ca 30 mm total length in a number of separate studies carried out at 10 °C (Buchholz *et al.*, 2006; Cuzin-Roudy and Buchholz, 1999 and unpublished data). This value also falls close to a regression line of a combination of laboratory experiments and field assessments of IMP (Fig. 1 from Cuzin-Roudy and Buchholz, 1999). Accordingly, we used this IMP value at 10 °C as an experimental standard. Furthermore, the regression parameters may be used to account for the effect of different environmental temperatures on IMP.

A set of maintenance experiments used this IMP-temperature relationship to test for the regularity of moulting and growth (Cuzin-Roudy *et al.*, 2004). Again, the majority of IMPs, either determined by counting the number of days between consecutive moults, or by extrapolation of the numbers of moulted specimens per day, confirmed the relationship. However, at a temperature of 8 °C, longer than expected IMPs were observed (see below).

Temporal variation of the IMP follows a fixed mechanism while the rhythmicity of the moult cycle appears to have a certain degree of autonomy independent of environmental factors. However, there are two 'windows' in the moult cycle where the timing can be adjusted. These are the so-called 'resting stages' C and D2. The last sub-stage within stage C is C4, according to Drach (1939): at this stage tissue and reserves are deposited until the next premoult phase can be initiated. If trophic input does not suffice, C4 is prolonged. This stage is sometimes referred to as 'intermoult', a term that should be avoided to be not confused with the 'IMP'. Additionally, in stage D2, a crustacean is ready to moult. The actual moult may then be triggered by the ecdysone peak and continue without further hormonal modulation. Apparently, a negative signal, be it the presence of predators, low temperature or lack of food may depress the hormonal trigger and delay the moult until the situation improves. This mechanism may be the cause of the outliers in the experiments and the field data above (Fig. 6.3).

The black rhombus in Fig. 6.3 represents non-reproductive krill in a wintery Clyde Sea situation and the round symbols, non-reproductive

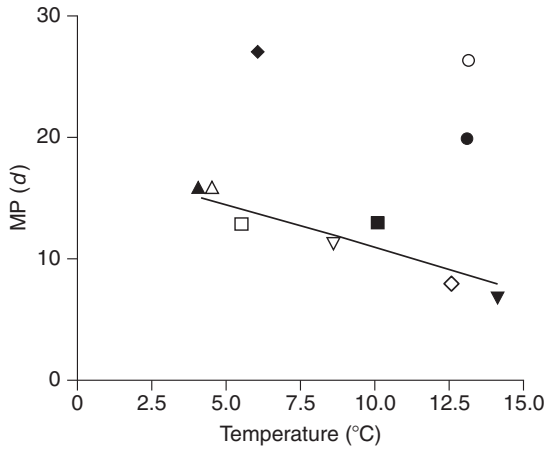

Figure 6.3 Relationship between intermoult period and temperature (graph from Cuzin-Roudy and Buchholz, 1999; with permission): white symbols: lab; black symbols: field, samples from Ligurian sea, Clyde sea and Kattogat. $IMP = 19.11 - 0.843 \text{ Temp}$, $r = 0.94$; $p < 0.002$. The three outliers denote non-reproductive krill.

Ligurian sea krill. The trophic input in the former apparently does not suffice to sustain moulting: in the Ligurian Sea krill, growth and reproduction coincides with the very short spring phytoplankton bloom. The Mediterranean krill analysed was either from before this phase or well after (September) when krill is considered to be in a quiescent ‘oversummering’ mode, typical for the oligotrophic Mediterranean (Saborowski and Buchholz, 2002). Also typical is the stable temperature, close to 13 °C all year in the Ligurian sea. In such thermally stable conditions, the influence of the trophic environment overrides any temperature effect on moulting and growth.

The observation of prolonged IMP in krill in the Gullmarsfjord (Cuzin-Roudy *et al.*, 2004) may also be associated with such a trophic effect. Cuzin-Roudy *et al.* (2004) estimated IMP in autumn in three consecutive years and found it to fit the temperature-IMP regression in one year, but to be much longer in the two other years. Cuzin-Roudy *et al.* (2004) considered that the amount of suitable available food was much less in the autumns of the two long IMP years, which was also reflected in the fact that females in the population were in an advanced stage of ovarian regression.

In these cases, the width of the C/D2—window may be the point of adjustment in the timing of moulting, depending on trophic input. However, IMP may be varied by temporal variation of most major moult stages at the same time in response to a suite of other cues, particularly reproductive processes (Buchholz *et al.*, 2006).

Laboratory maintenance is the only way to differentiate the effect of the two parameters IMP and INC on growth rate: an adjustment of growth to environmental cues can be brought about by variation of either or both of these parameters. In Antarctic krill, the typical plasticity in growth is achieved by simultaneous variation of both parameters, including the occurrence of negative growth increments under very unfavourable conditions (Buchholz, 1991).

INC was calculated from the size increase between the cast exoskeleton and the postmoult specimen. Usually, carapace, uropod or antennal scale length are measured in each and compared to determine proportional increase or decrease in length. This can be calibrated against total body length or even body weight to estimate growth rate per moult. Knowledge of the moult rate (or IMP) then allows estimates of absolute growth rates (mm d^{-1} , mg d^{-1}).

A wide variation in INC has been noted in the maintenance experiments of *M. norvegica* cited above. On krill from Gullmarsfjord, our own unpublished measurements showed that INC was very variable, and ranged between -6.0% and $+6.0\%$ per moult with a mean of 0.72 (SD: 3.72; n : 25). Cuzin-Roudy *et al.* (2004) state that INC was not statistically different from zero and variable (-0.1% to 0.1% ; n : 72). Accordingly, these measurements cannot be taken to differentiate relationships in the co-variation of IMP and INC. Maintenance procedures may contribute to these observed variations (see below).

The interdependence of the two moult parameters has not been well studied. However, the common hypothesis (Adelung, 1971; Hartnoll, 1982) is that crustaceans start to accumulate body reserves immediately after the post-moult period. If these suffice, the next pre-moult phase is initiated without pause, eventually leading to a further moult. In most cases, this mechanism implies that the size increase at moult stays constant because it is associated with the status of the body mass present. In contrast, IMP may be adjusted according to the feeding conditions encountered while passing through one moult cycle. The typical INC of brachyuran crabs is near 27%, which corresponds roughly to a doubling in volume of the crab (Adelung, 1971; Hartnoll, 1982). However, in euphausiids, INC is between 4% and 10% and another mechanism of moult prevails (Buchholz, 2003). INC and IMP can be varied at the same time, giving the opportunity to flexibly co-adjust growth alongside energetic demands and energy intake. In this way, moulting may be tuned to the temporally variable and typically patchy trophic environment of the open sea. Under favourable trophic conditions, fast growth rates can be achieved in this way.

2.4. Coordination of moult and reproductive cycles

Cuzin-Roudy and Buchholz (1999) illustrated that moulting and spawning in female *M. norvegica* are interlinked processes. A model was presented in which eggs were released during the early premoult phase in two to three

consecutive spawning events. Then moult occurs three days after spawning has been completed. After moult, females enter a 'vitellogenic moult cycle' (VMC) where a new egg batch is developed but not released. After a further moult, they enter a 'spawning moult cycle' (SMC) where the eggs are released in the early premoult stage and the cycle is repeated. Both the VMC and SMC are of equal duration (see Chapter 7).

The bi-phasic spawning-moult cycle appears to be linked to behavioural traits. According to [Tarling *et al.* \(1999a\)](#), ready to spawn females are almost exclusively found in the surface layer at night, generally closer to the surface than males. Meanwhile, moulting specimens occur deep in the water column. As a consequence, in females, moulting as well as spawning are directly linked to a highly coordinated and cyclical vertical migratory behaviour with a time scale of 24 h which, in turn, depends on a complex set of controlling factors, for example light, predators (avoidance), trophic-, temperature-, and salinity-regimes. Underlying this is an endogenous rhythm synchronised by external factors or 'Zeitgebers', most notably light (see [Gaten *et al.*, 2008](#); [Tarling *et al.*, 1999b](#) for further discussion). Accordingly, moulting in Northern krill is closely coordinated with cycles of vertical migration and spawning in order to optimise overall physiological performance. Spawns however occur at a predetermined time window of the SMC, temporally well separated from ecdysis, while vitellogenesis is coupled to the following moult cycle, the VMC. Vitellogenesis, as well as egg maturation is under the control of neuro-hormones, produced in the eyestalks of the krill, which most likely coordinate the whole set of complex cycles ([Covi *et al.*, 2009](#); [Subramoniam, 2000](#)).

In summary, vertical migration behaviour, moult and reproductive processes are functionally linked. The temporal coordination of these complex functions, with different time scales, depends on the synchronisation of physiological processes within the individuals. Such synchronisation may also occur at the level of the swarm ([Tarling *et al.*, 1999b](#)). However, synchrony in swarms does not seem to persist over longer, annual timescales (see below). Presumably, the situation met in the [Tarling *et al.* \(1999b\)](#) study may have been typical for a summer situation when external conditions were optimal in terms of temperature and the prevailing feeding conditions.

2.5. Growth versus reproduction

Crustaceans display a certain 'periodicity and phasing' in their growth that is set by their pattern of moulting. Regional as well as seasonal differences have been observed between and within species. The variations are directly or indirectly influenced by temperature regimes and other environmental conditions like photoperiod or food availability ([Conan, 1985](#) and references therein). Animal size, be it species specific or age dependent, is also always inversely correlated with IMPs, as shown for euphausiids by [Fowler](#)

et al. (1971), Mauchline (1980) and Buchholz (1991) and compiled for other crustaceans by Hartnoll (1982). Evolution of genetic traits phasing moult and reproduction seems indispensable since, in most crustaceans, mating occurs between a hard (late postmoult) males and a soft (just postmoult) females. Moreover, the common crustacean trait of brood carrying, where eggs are attached to integumental setae, in some cases only present in a specific 'breeding dress' (e.g. *Palaemonetes varians*, Jefferies, 1964; for other examples see Nelson, 1991), often requires the extension of IMPs because the eggs would otherwise be lost with the exuvia during ecdysis (Conan, 1985; Hartnoll, 1985; Nelson, 1991). For the great majority of euphausiids that spawn freely, this can be discounted. Nevertheless, Hartnoll's (1985) general conclusion that "reproduction can never enhance [somatic] growth but must always restrict it" seemed until recently to be true for euphausiids as well. In a short-term (13 d), small scale (30 × 30 nm) study on 38 swarms (Buchholz *et al.*, 1996) *E. superba* continued moulting during the breeding period, while the familiar pattern of gravid females having a longer IMP (13 d) than mature males (8.3 d) of a similar body length was found. The same swarm study indicated that, after production and spawning of eggs had ceased, females moulted more frequently again. From an extensive study by Tarling *et al.* (2006) it must be concluded that, more commonly, mature female *E. superba* moult more often than mature males. Moreover, female *E. superba* maintained in the laboratory after the final spawning of the year continued moulting, but regressed in sexual maturity and size while extending their IMP (Thomas and Ikeda, 1987). The authors also reported that, after rematuration of external sexual characteristics and concurrent with maturing ovaries, a reduced IMP and positive growth increment lead to an overall size increase compared to the start of the experiment (provided food was sufficient).

In the course of our studies on Northern Krill, sex dependent differences in moulting became conspicuous at three locations and at different time scales (Buchholz *et al.*, 2006). Not only did sexual maturation result in a synchronisation effect on females at the population level (Tarling and Cuzin-Roudy, 2003) and modulate female vertical migration patterns (Tarling *et al.*, 1999b), but it also increased their moult frequency compared to males, at least temporarily. This pattern was observed at both a seasonal scale (in the Clyde population, Scotland) and at a weekly scale (in the Gullmarsfjord population, Sweden and the Kattegat, near Denmark) and through the use of different techniques: the assessment of the ratio of moulting females/moulting males in field samples and the daily checking for moulting in incubated specimens. Overall, female body length was equal to that of males, an indication that the overall net growth was similar, despite the fact that females moulted more often. Furthermore, the shortened IMPs in females were not a result of the abbreviation of specific moult stages, but of an equiproportional shortening across all moult stages, except

those in 'moult'. Accordingly, reproductive activity in females did not alter the course of the normal moult cycle.

Thomas and Ikeda (1987) similarly found that moulting and somatic growth continued during egg development in *E. superba*. In both *E. superba* and *M. norvegica*, it is apparent that despite the amount of resource invested in the ovary, there is still spare energy to channel into somatic growth. An increase in size is important since it, in turn, enhances further fecundity given the strong positive correlation between body size and brood size (Cuzin-Roudy, 2000; Mauchline, 1980; Mauchline and Fischer, 1969). Larger individuals also have a higher swimming capacity, which increases their chances of finding new plankton patches and insuring continued energy intake (Buchholz, 1991). Alternatively, large ready to spawn females may have a greater swimming capacity to migrate into the warmer surface layers of the water column which may be beneficial to the development of their brood (Tarling *et al.*, 1999b).

It seems that female Northern krill in a number of different populations are able to combine growth and reproduction in a way that they achieve similar net growth rates to males. This feature is also common to growth patterns in Antarctic krill. It reflects that energy intake in both species must be high to fuel both processes simultaneously, a fact that may also be a reason for the ecological success of this group.

3. PRACTICAL APPROACHES

3.1. Laboratory maintenance and catch of specimens

Experience in laboratory maintenance of euphausiids has shown that *E. superba* is a hardy animal that can be incubated for months in both through-flow and fixed volume aquaria (Buchholz, 1991). Unfortunately, individual juvenile and adult *M. norvegica* do not survive well in aquaria for longer than a maximum of 3–4 weeks. While it is difficult to isolate a single reason, the most probable cause is bacterial infections of the integument. Coryne-type bacteria were isolated and identified from infections in the cuticle of moribund specimens. These bacteria belong to a group with a chitinolytic capacity which may affect the survival of specimens (Buchholz, unpublished). Experiments applying antibiotics were not successful for as yet unknown reasons. Frequent water exchange and/or better flow through systems can alleviate the problem but not solve it completely. A prerequisite is the careful capture of specimens, avoiding damage to the integument, particularly to the long and fragile antennae, filtering basket and pleopods. This begins with the method of catch. Opening/closing nets (Tucker Trawl, MOCNESS) allow catches to be aimed at krill marks on echosounder traces, avoiding lengthy tows, particularly through warmer

surface layers. Soft and large mesh netting (min. 2 mm), short trawling times (10 min) and slow ship speed (2 kn) is recommended. After the catch, specimens should immediately be transferred to cooled seawater. After 10 min, they should be further sorted individually into a large bin for acclimation. Prior to physiological experiments, acclimation time in test chambers etc. should last for at least 6 h. Containers for maintenance should not be too small, that is at least 1 l of seawater for a single specimen. Through flow systems, preferably with a current induced in the containers, is advantageous (Fig. 6.4; Buchholz, 1991).

Artemia or natural zooplankton collected with a small net, preferably in combination with cultured phytoplankton, may serve for food. Systems in which the krill exhibit zero or negative growth increments may indicate that the holding conditions are inadequate.

3.2. Moulst staging

Details on the categorisation of moulst stages are given above. The staging method is best applied to live krill. First, cuticle hardness is tested with fine forceps, particularly at the (anterior) rims of the carapace. Subsequently one or both outer uropods are detached, placed on a slide with cover-glass and analysed under a microscope with 100–400 \times magnification (Fig. 6.2).

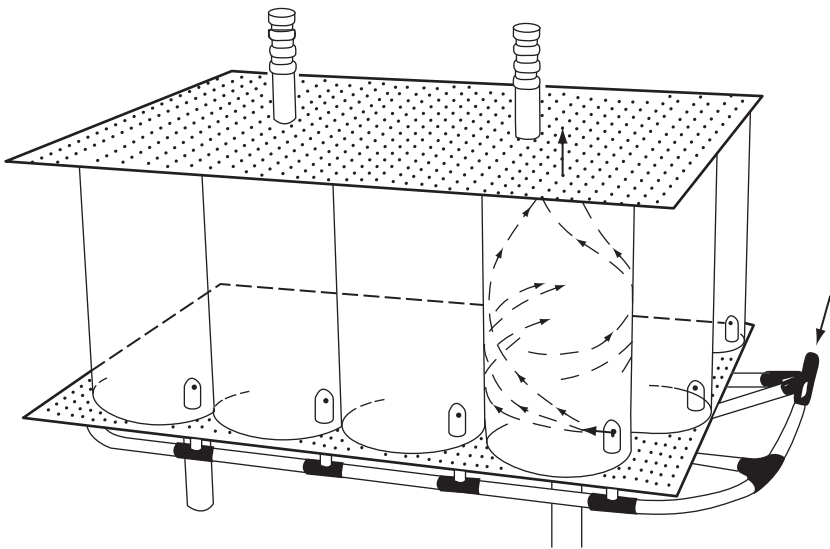

Figure 6.4 Inset for maintenance tanks from Buchholz (1991) (with permission), consisting of 18 Perspex tubes for individual krill. The flow of seawater and resulting laminar current inside a chamber is shown by arrows. The PVC-top is removable.

A phase contrast facility is helpful. Antennal scales may be used instead of uropods with no detectable bias in results.

The technique is partly applicable to defrosted krill, on condition that they are rapidly frozen post-capture and analysed immediately after defrosting (Buchholz, 1991). Krill preserved in formalin is more difficult to categorise in terms of moult stage as the cuticle rigidity is modified through the process of fixation. It may nevertheless be performed successfully given a certain level of experience built up on analysing fresh samples. It is likely that only the major moult stages (post-, premoult) are distinguishable in such preserved specimens.

3.3. Field assessment of IMP and moult activity

Field data attempting to describe the frequency of moulting over the course of the life history of krill are sparse, although there has been some attempts, at a range of time scales. One method is to assess the proportion of 'moulting' or 'non-moulting' specimens at various time points in the year, assuming that moulting is random in the population and each time point provides a good representation of the general level of moulting activity, of which the inverse is a means of estimating IMP (see below). Alternatively, a more sophisticated staging system can be applied, where individual moult stages are identified in laboratory incubated specimens (Buchholz, 1991; Cuzin-Roudy and Buchholz, 1999). Combining both approaches provides insights into moulting patterns over short and long timescales and between different populations, as demonstrated in Buchholz *et al.* (2006). The approach has been successfully adapted for mysids (Gorokhova, 2002).

The 'moulting' or 'moult active' stages comprise stages A and D3, which last for 14.7%, of the moult cycle, or 1.9 d at a standard temperature of 10 °C. This period is believed to be independent of temperature and nutrition and can thus be considered temporally fixed. Using this value, and having determined the percentage of krill found in stages D3 and A, the duration of the IMP can be assessed in a field population as follows:

$$\text{IMP}(d) = \frac{1.9}{\%D3 + A} \times 100. \quad (1)$$

However, it is not always feasible to distinguish moult stage A from B, since cuticle hardening is still on-going as endo-cuticle laminae are added and sclerotization continues throughout the new shell layers in stage B (Buchholz and Buchholz, 1989). Therefore, an alternative is to include all krill that have not attained complete cuticle rigidity, so adding the duration of stage B (7.4%) to Eq. (1), corresponding to a new total for stages D3, A and B of 2.9 d. The corresponding algorithm is therefore as follows:

$$\text{IMP}(d) = \frac{2.9}{\%D3+A+B} \times 100. \quad (2)$$

To assess and compare the potential for growth between locations or seasons, the relationship between the numbers of 'moult active' to 'moult inactive' specimens can be determined. The moult active fraction consists of krill actually involved in the immediate preparation for moult, ecdysis itself or the early consolidation of the cuticle after moult. This phase (D3 A B) has been found to comprise 22% of a moult cycle in an actively moulting population, meaning that if random moulting is going on in a population, 22% of the krill can be expected to be found in that phase (see above; Buchholz *et al.*, 2006). Accordingly, comparison of the observed percentage against this number is an indicator of whether a population is active with regards moult and growth or whether it is in a quiescent state and spending proportionally larger amounts of time in, for instance, stages, C and D2 (Buchholz *et al.*, 2010), so decreasing the proportion of moult active specimens.

3.3.1. Moulting frequency

Cuzin-Roudy and Buchholz (1999) assessed 'moulting frequency' in large samples of individually maintained krill. A simple extrapolation to 100% of the cumulative percentage of moulted krill at the end of the maintenance period was used to estimate IMP, given that the time available during the sampling cruise, and thus maintenance period, was shorter than a complete IMP.

3.3.2. Moulting frequency through instantaneous growth rates

In *E. superba*, the first moult under maintenance conditions is always the moult with the largest INC (Buchholz, 1991). Apparently, the growth increment at moult is more sensitive to maintenance induced effects than the IMP. As a consequence, incubations should be kept as short as possible to avoid such artefacts. This led to development of the 'instantaneous growth rate' method for assessing growth in Antarctic krill (IGRs; Quetin and Ross, 1991) which has since been widely used and improved (Tarling *et al.*, 2006; see Chapter 3). The IGR technique is fully applicable to *M. norvegica* and other euphausiids (Pinchuk and Hopcroft, 2007).

3.3.3. Moulting synchrony

A pre-requisite for all the methods mentioned above is that moulting in the field is random. If this were not the case, data could be strongly biased and growth rate either under- or overestimated, depending on the phase of the moult cycle in which capture and incubations were made. Mass moults and peaks in certain stages of sexual development have been observed indicating

a synchronisation of the moult and reproductive activity in some circumstances (Buchholz *et al.*, 1996; Tarling and Cuzin-Roudy, 2003). However, using the results from an extensive study on 38 swarms of Antarctic krill (Buchholz *et al.*, 1996; Watkins *et al.*, 1992), it was concluded that synchrony in moulting is more the exception than the rule. Furthermore, it may be restricted to single swarms or, smaller aggregations, and probably only lasts for relatively short periods. However, as a precaution, IGR or field moult assessments should not rely on a single sample only. To represent a larger area, at least three different samples taken some distance apart should be analysed independently. It would be desirable also to pay attention to the moult synchronisation of individuals in future swarming studies to be able to improve insights into the extent of this phenomenon.

4. GROWTH IN THE FIELD ALONG A CLIMATIC GRADIENT

4.1. Seasonal timing, synchronisation and autonomy of moulting

M. norvegica is mainly found in—often very dense—layers or swarms and is an extremely prolific diurnal vertical migrator. Moulting and spawning rhythms are coordinated with vertical migration (Tarling *et al.*, 1999b), where spawning happens in the warm surface layers and moulting in the cool and safer depths. This short-term rhythmicity is linked to a synchronisation of the egg maturation cycle with the moult cycle, which has a period of ~ 2 weeks (Cuzin-Roudy and Buchholz, 1999). Patterns are also apparent at the seasonal scale: in *M. norvegica*, pulses of enhanced plankton production elicit a synchronisation of both moulting and spawning in a swarm for a certain period of time, after which such coordination slowly vanishes (Tarling and Cuzin-Roudy, 2003). A subsequent pulse of productivity may induce synchrony again. Linked to a flexible omnivorous diet (Lass *et al.*, 2001), such synchronisation may be a plastic physiological reaction to temporal oscillations in the trophic environment. Synchronisation was also found in Antarctic krill (Buchholz, 1985) and a recent study in *Euphausia hanseni* indicated that moult and spawning may be closely controlled by up-welling events which induce sudden changes in trophic conditions (Buchholz, unpublished). Further comparative work on the cues for physiological rhythmicity and synchronisation in krill swarms would be highly desirable in pelagic species.

On an individual basis, a further interesting trait of krill is its tendency to continue moulting even in unfavourable conditions, for example extended periods of starvation, when they may even shrink at moult (Buchholz, 2003). Apparently, krill moult autonomously, that is de-coupled from the necessity to grow, although the moult rate may vary to some degree in line

with conditions. It indicates that the process is controlled by a strong endogenous rhythm. Ultimately, the trait may provide some selective advantage in ensuring a clean and fresh epicuticle, free of drag-inducing epibionts, which may otherwise hinder its fast swimming-capability (Buchholz and Buchholz, 1989; Buchholz *et al.*, 2006).

4.2. Life-growth assessments

A way to illustrate growth over time is to plot body length versus month of the year over the life time of the species. Einarsson (1945) provided one of the first such plots using data collected over a wide geographic range, from Iceland to the NE Atlantic. Accordingly, a seasonal growth pattern was described. This was used by Boysen and Buchholz (1984) as a reference for Northern krill in the Danish Kattegat (Fig. 6.5). The curve shows that growth slows with increasing age. Furthermore, the growth period is closely correlated to seasonal food availability, being most pronounced from April to October in the 0-group. During the winter months, when the abundance of phyto- and zooplankton is scarce, there is little increase in size. In the II-group, growth re-gains momentum towards summer. In the case of the 0-group, a wide range in lengths are apparent. This phenomenon is due to the long and irregular spawning time, from April to September. The spread

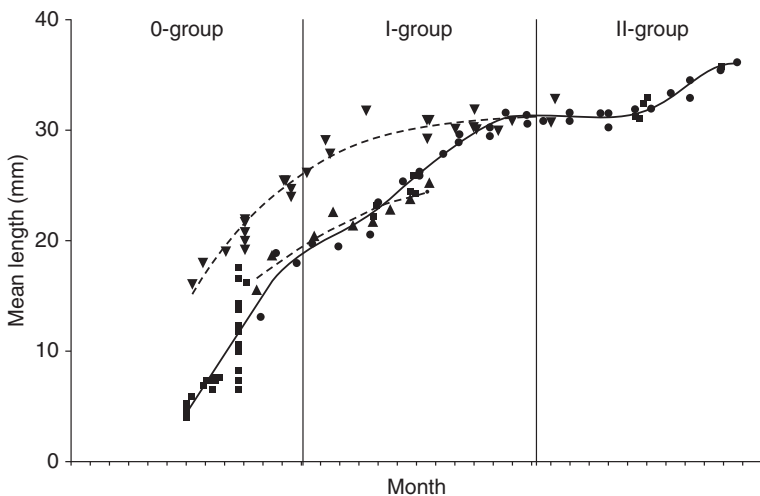

Figure 6.5 Hypothetical Life-Growth curves of *Meganyctiphanes norvegica* in NE Atlantic waters and the Mediterranean. Dots: Boysen and Buchholz (1984), Kattegat; squares: Einarsson (1945), NE Atlantic; triangles: Falk-Petersen and Hopkins (1981), Balsfjorden; triangles (pointing down): Labat and Cuzin-Roudy (1996), Ligurian sea. Vertical lines: annual limits, December-January. Reproduced with permission.

of the data diminishes considerably with increasing age. Within this data, the life span of Northern krill is 2.5 years during which it attains a maximal length of 36 mm. Other datasets presented by Tarling (Chapter 3) show that Northern krill may reach beyond 3 years of age in some more northerly locations.

In the Mediterranean Northern krill population (Labat and Cuzin-Roudy, 1996), recruitment starts earlier in the year so the 0-group krill are generally more advanced and larger than other populations relative to calendar date. However, the actual trajectory of growth in 0-group individuals is similar to other populations and they converge at the I-group stage (~ 30 mm body length). Throughout the summer months, growth is relatively low in I-group individuals from this population, which probably reflects the poor trophic conditions in summer in the Mediterranean. A true II-group is missing in this population, probably due to predation mortality.

Data points from Falk-Petersen and Hopkins (1981) from Balsfjorden ($69^{\circ}21'N$; $19^{\circ}06'E$) are included in Fig. 6.5 to represent high latitude populations. These generally fit the NE Atlantic population trajectory (Einarsson, 1945). The krill are presumably advected from the open Norwegian sea and may reflect its environmental condition rather than the fjord situation. Norwegian sea krill are believed to contain the northernmost self sustaining population of *M. norvegica* (Dalpadado *et al.*, 2008; Buchholz *et al.*, 2010).

'Fjord-krill' grow faster and more continuously and attain a larger size than open-ocean populations. This is true for western Norwegian fjords (Wiborg, 1971; see Boysen and Buchholz, 1984, also for more comparisons) as well as the western Swedish Gullmarsfjord and the Scottish Clyde sea: the growth curves (Cuzin-Roudy *et al.*, 2004) are similar to the NE Atlantic curve during the first year (0-group), but show much faster and continued growth through the second year (I-group). Accordingly, end sizes of up to 43 mm are reached. This probably reflects krill profiting from the enhanced plankton production through nutrient fertilisation from the land surrounding fjords (Buchholz *et al.*, 2010).

Interestingly, Siegel (2000) states that the life-growth curve in Antarctic krill has a similar trajectory to the Northern krill curve, with the difference being that Antarctic krill continues to grow over 5 years to an end-size of 60mm—whereas the Northern krill stops growing at around 2.5 years at a size of around 35–40 mm. It suggests that the physiological performance of the two species is comparable, at least in the first two years of life.

As a conclusion, *M. norvegica* in the open waters of the North Atlantic and fringe seas show a comparable seasonal growth pattern. Apparently, growth is much dependent on the trophic situation and seasonal pattern of nutrition rather than the latitudinal position, that is climatic influences. Variation in local environmental and trophic regimes affects other body dimensions also. For instance, differences in weight are noted which run on a different time course to increases in body length. According to the

nutritional situation, krill of the same length may have a different weight—with the ratio of tissue to water altering between specimens (see discussion in [Boysen and Buchholz, 1984](#)). Much of the difference is seen in the protein and lipid fractions, which constitute the reserves used for ovary maturation and overwintering ([Falk-Petersen et al., 2000](#)).

5. AN OUTLOOK: GROWTH, PRODUCTIVITY AND ENVIRONMENTAL CHANGE

M. norvegica must be considered an eurythermal species since it occurs from the Arctic to the Mediterranean, over which area, mean sea-surface temperature changes by over 13 °C. Indeed, Northern krill has been used as a model organism to consider adaptation in the marine pelagic environment within a cooperative European project entitled “Impact of a climatic gradient on the Physiological Ecology of a Pelagic crustacean (PEP)”. Populations were studied from the thermally variable Danish Kattegat, the cool and stable Atlantic Clyde Sea and the warm and stable Ligurian sea.

From the above project and other studies on growth, reproduction and physiological performance, it has been shown that nutritional flexibility and high-energy expenditure are characteristic features of *M. norvegica* and that fitness appears to be maximised through seasonal shifts in behavioural and physiological traits. Molecular work has shown some unique features in Northern krill, helping to explain functional diversity in the species ([Zane et al., 2000](#)). Physiological plasticity appears to be the key to the euphausiid's exceptional ecological success in various environments, brought about by fast growth and reproduction ([Buchholz and Saborowski, 2000](#)).

These studies enable us to come to some preliminary conclusions with regards the resilience of this species to climate variability and change. The Northern krill populations spread around the various margins of the NE Atlantic differ in certain traits but are not genetically separated from each other (see Chapter 2), even if their local climates and thermal regimes are distinctly different. A further unexpected finding of the genetic analysis was that an Atlantic population off Cadiz, S. Spain, differed substantially from all the other populations investigated. The swarm sampled may have been advected from warmer Atlantic regions, presumably from near the Canary Islands. This finding indicates that the species may tolerate even warmer temperatures than experienced in the Mediterranean. Although the physiological properties of this southern population are not known, it illustrates that *M. norvegica* can in fact cope with an extremely wide range of (changing) environmental temperatures, demonstrating a high degree of phenotypic plasticity with regards eurythermy. Accordingly, krill may easily adjust to the higher temperatures, predicted by many future climate scenarios. However,

metabolic energy expenditure increases strongly with rising temperature, potentially leading to the loss of energy needed for maintenance of growth and reproduction. As a vertically migrating species, Northern krill may adapt through altering its vertical distribution or the amount of time spent in surface waters.

In general, Northern krill swarms or populations are found in areas where feeding is enhanced by environmental conditions, particularly linked to the existence of frontal systems, for example at the continental slopes or generally, areas of enhanced advection. Increase in sea temperatures may cause changes in the species composition of phyto-, and zooplankton communities associated with these food-rich areas. Due to the versatility in food choice in Northern krill, this may not necessarily create a major problem and the species may even benefit from certain changes. The well developed vertical and horizontal swimming capacity of adults make it capable of searching out alternative food patches or relocating to other frontal systems.

The northernmost record of Northern krill populations had been the Arctic Barents Sea which are, so far, considered non-reproductive (Dalpadado *et al.*, 2008). However, there are increasing numbers of reports from the west-Spitsbergen area to which *M. norvegica* seems to be regularly advected. In the Kongsfjord, there are even the first indications of reproductive processes in krill (Buchholz *et al.*, 2010). These observations may be taken as a further indication of a warming effect or a change in food web composition which may be advantageous to Northern krill, enabling it to expand its distributional range northwards. Accordingly, Northern krill may serve as a useful indicator of change. Their proliferation in new environments may also have implication to those food webs, given their high levels of productivity and their pivotal trophic role.

ACKNOWLEDGEMENTS

Part of the work was funded by the German Science Foundation (DFG) grants Bu 548 1-2 and EU-MAST III (Marine Science and Technology) grant MAS3-CT95-0013, The PEP Programme: Impact of a climatic gradient on the Physiological Ecology of a Pelagic crustacean. On behalf of the 'PEP-community' and their followers Geraint Tarling is thanked for his lasting and consistent enthusiasm and interest in its target: the Northern krill, which in the end led to the collation of the current review. Last not least we are grateful to Geraint and Paul Seear for considerable improvements of the text. Figures and tables from Mar Biol and MEPS were reproduced with kind permission of Springer Science+Business Media, those from J Plankton Res of Oxford University Press.

REFERENCES

- Adelung, D. (1971). Untersuchungen zur Häutungsphysiologie der dekapoden Krebse am Beispiel der Strandkrabbe *Carcinus maenas* L. *Helgoländer wiss. Meeresunters.* **22**, 66–119.

- Boysen, E., and Buchholz, F. (1984). *Meganyctiphanes norvegica* in the Kattegat. Studies on the development of a pelagic population. *Mar. Biol.* **79**, 195–207.
- Buchholz, F. (1982). Drach's molt staging system adapted for euphausiids. *Mar. Biol.* **66**, 301–305.
- Buchholz, F. (1985). Moulting and growth in euphausiids. In "Antarctic Nutrient Cycles and Food Webs, Proceedings of the 4th SCAR Symposium on Antarctic Biology" (W. R. Siegfried, P. Condy and R. M. Laws, eds.), pp. 339–345. New York, Springer.
- Buchholz, F. (1991). Moulting cycle and growth of Antarctic krill, *Euphausia superba*, in the laboratory. *Mar. Ecol. Prog. Ser.* **69**, 217–229.
- Buchholz, F. (2003). Experiments on the physiology of Southern and Northern krill, *Euphausia superba* and *Meganyctiphanes norvegica*, with emphasis on moulting and growth—A review. *Mar. Freshw. Behav. Physiol.* **36**, 229–247.
- Buchholz, C., and Buchholz, F. (1989). The ultrastructure of the Integument of a pelagic crustacean: Moulting cycle related studies on *Euphausia superba*. *Mar. Biol.* **101**, 355–365.
- Buchholz, F., and Saborowski, R. (2000). Metabolic and enzymatic adaptations in the Northern and Southern krill, *Meganyctiphanes norvegica* and *Euphausia superba*. *Can. J. Fish. Aquat. Sci.* **57**(Suppl. 3), 115–129.
- Buchholz, C. M., Pehlemann, F. W., and Sprang, R. R. (1989). The cuticle of krill (*Euphausia superba*) in comparison to that of other crustaceans. *Pesq. Antart. Bras.* **1**, 103–111.
- Buchholz, F., Watkins, J. L., Priddle, J., Morris, D. J., and Ricketts, C. (1996). Moulting in relation to some aspects of reproduction and growth in swarms of Antarctic krill, *Euphausia superba*. *Mar. Biol.* **127**, 201–208.
- Buchholz, C., Buchholz, F., and Tarling, G. A. (2006). On the timing of moulting processes in reproductively active Northern krill *Meganyctiphanes norvegica*. *Mar. Biol.* **149**, 1443–1452.
- Buchholz, F., Buchholz, C., and Weslawski, J. M. (2010). Ten years after: Krill as indicator of changes in the macro-zooplankton communities of two Arctic fjords. *Polar Biol.* **33**(1), 101–113.
- Conan, G. Y. (1985). Periodicity and phasing of molting. In "Crustacean Issues 3" (F. A. Schram and A. M. Wenner, eds.), pp. 73–99. A. A. Balkema, Rotterdam, Boston.
- Covi, J. A., Chang, E. S., and Mykles, D. L. (2009). Conserved role of cyclic nucleotides in the regulation of ecdysteroidogenesis by the crustacean molting gland. *Comp. Biochem. Physiol. A* **152**, 470–477.
- Cuzin-Roudy, J. (2000). Seasonal reproduction, multiple spawning, and fecundity in northern krill, *Meganyctiphanes norvegica*, and Antarctic krill, *Euphausia superba*. *Can. J. Fish. Aquat. Sci.* **57**, 6–15.
- Cuzin-Roudy, J., and Buchholz, F. (1999). Ovarian development and spawning in relation to the moulting cycle in Northern krill, *Meganyctiphanes norvegica* (Crustacea: Euphausiacea), along a climatic gradient. *Mar. Biol.* **133**, 267–281.
- Cuzin-Roudy, J., Tarling, G. A., and Strömberg, J.-O. (2004). Life cycle strategies of Northern krill (*Meganyctiphanes norvegica*) for regulating growth, moulting, and reproductive activity in various environments: The case of fjordic populations. *ICES J. Mar. Sci.* **61**, 721–737.
- Dalpadado, P., Ellertsen, B., and Johannessen, S. (2008). Inter-specific variations in distribution, abundance and reproduction strategies of krill and amphipods in the Marginal Ice Zone of the Barents Sea. *Deep Sea Res.* **55**, 2257–2265.
- Drach, P. (1939). Mue et cycle d'intermue chez les Crustacés décapodes. *Ann. Inst. Oceanogr (Monaco)* **19**, 103–391.
- Einarsson, H. (1945). Euphausiacea. I. Northern Atlantic species. *Dana-Rep. Carlsberg Found* **27**, 1–184.

- Falk-Petersen, S., and Hopkins, C. C. E. (1981). Ecological investigations on the zooplankton community of Balsfjorden, northern Norway: Population dynamics of the euphausiids *Thysanoessa inermis* (Kroyer), *Thysanoessa raschii* (M. Sars) and *Meganyctiphanes norvegica* (M. Sars) in 1976 and 1977. *J. Plankton Res.* **3**, 177–192.
- Falk-Petersen, S., Hagen, W., Kattner, G., Clarke, A., and Sargent, J. (2000). Lipids, trophic relationships, and biodiversity in Arctic and Antarctic krill. *Can. J. Fish. Aquat. Sci.* **57** (Suppl. 3), 178–191.
- Fowler, S. W., Small, L. F., and Keckeš, S. (1971). Effects of temperature and size on molting of euphausiid crustaceans. *Mar. Biol.* **11**, 45–51.
- Gaten, E., Tarling, G., Dowse, H., Kyriacou, C., and Rosato, E. (2008). Is vertical migration in Antarctic krill (*Euphausia superba*) influenced by an underlying circadian rhythm? *J. Genet.* **87**, 473–483.
- Gorokhova, E. (2002). Moulting cycle and its chronology in *Mysis mixta* and *Neomysis integer* (Crustacea, Mysidacea): implications for growth assessment. *J. Exp. Mar. Biol. Ecol.* **278**, 179–194.
- Hartnoll, R. G. (1982). Growth. In “The Biology of Crustacea 2” (D. E. Bliss and L. G. Abele, eds.), pp. 111–196. Academic Press, New York, NY.
- Hartnoll, R. G. (1985). Growth, sexual maturity and reproductive output. In “Crustacean Issues 3” (F. A. Schram and A. M. Wenner, eds.), pp. 101–128. A.A. Balkema, Rotterdam.
- Jefferies, D. J. (1964). The moulting behaviour of *Palaemonetes varians* (Leach) (Decapoda; Palaemonidae). *Hydrobiologia* **24**, 457–488.
- Johnson, C. L. (2003). Ecdysteroids in the oceanic copepod *Calanus pacificus*: Variation during molt cycle and change associated with diapause. *Mar. Ecol. Prog. Ser.* **257**, 159–165.
- Labat, J. P., and Cuzin-Roudy, J. (1996). Population dynamics of the krill *Meganyctiphanes norvegica* (M. Sars, 1857) (Crustacea: Euphausiacea) in the Ligurian Sea (NW Mediterranean Sea). Size structure, growth and mortality modelling. *J. Plankton Res.* **18**(12), 2295–2312.
- Lass, S., Tarling, G. A., Virtue, P., Matthews, J. B. L., Mayzaud, P., and Buchholz, F. (2001). On the food of northern krill *Meganyctiphanes norvegica* in relation to its vertical distribution. *Mar. Ecol. Prog. Ser.* **214**, 177–200.
- Mauchline, J. (1980). The Biology of Mysids and Euphausiids. Academic Press, London \New York\Toronto\Sydney\San Francisco.
- Mauchline, J., and Fischer, L. R. (1969). The Biology of Euphausiids. Academic Press, London\New York.
- Nakatsuji, T., Lee, C. Y., and Watson, R. D. (2009). Review: Crustacean molt-inhibiting hormone: Structure, function, and cellular mode of action. *Comp. Biochem. Physiol. A* **152**(2), 139–148.
- Nelson, K. (1991). Scheduling of reproduction in relation to molting and growth in malacostracan crustaceans. In “Crustacean Issues 7” (F. A. Schram, A. W. Wenner and A. Kuris, eds.), pp. 77–113. A. A. Balkema, Rotterdam, Brookfield.
- Pinchuk, A. I., and Hopcroft, R. R. (2007). Seasonal variations in the growth rates of euphausiids (*Thysanoessa inermis*, *T-spinifera*, and *Euphausia pacifica*) from the northern Gulf of Alaska. *Mar. Biol.* **151**, 257–269.
- Quetin, L. B., and Ross, R. M. (1991). Behavioral and physiological characteristics of the Antarctic krill *Euphausia superba*. *Am. Zool* **31**, 49–63.
- Saborowski, R., and Buchholz, F. (2002). Metabolic properties in Northern Krill, *Meganyctiphanes norvegica*, from different climatic zones: Enzyme characteristics and activities. *Mar. Biol.* **140**, 557–565.

- Seear, P., Tarling, G. A., Teschke, M., Meyer, B., Thorne, M. A. S., Clark, M. S., Gaten, E., and Rosato, E. (2009). Effects of simulated light regimes on gene expression in Antarctic krill (*Euphausia superba* Dana). *J. Exp. Mar. Biol. Ecol.* **381**, 57–64.
- Shechter, A., Tom, M., Yudkovski, Y., Weil, S., Chang, S. A., Chang, E. S., Chalifa-Caspi, V., Berman, A., and Sagi, A. (2007). Search for hepatopancreatic ecdysteroid-responsive genes during the crayfish molt cycle: From a single gene to multigenicity. *J. Exp. Biol.* **210**, 3525–3537.
- Siegel, V. (2000). Krill (Euphausiacea) demography and variability in abundance and distribution. *Can. J. Fish. Aquat. Sci.* **57**(Suppl.), 151–167. (Proceedings of the Second International Symposium on Krill).
- Subramoniam, T. (2000). Crustacean ecdysteroids in reproduction and embryogenesis. *Comp. Biochem. Physiol.* **125**(2), 135–156.
- Tarling, G. A., and Cuzin-Roudy, J. (2003). Synchronization in the molting and spawning activity of northern krill (*Meganyctiphanes norvegica*) and its effect on recruitment. *Limnol. Oceanogr.* **48**, 2020–2033.
- Tarling, G. A., Matthews, J. B. L., and Buchholz, F. (1999a). The effect of a lunar eclipse on the vertical migration behaviour of *Meganyctiphanes norvegica* (Crustacea: Euphausiacea) in the Ligurian Sea. *J. Plankton Res.* **21**, 1475–1488.
- Tarling, G. A., Cuzin-Roudy, J., and Buchholz, F. (1999b). Vertical migration behaviour in the northern krill *Meganyctiphanes norvegica* is influenced by moult and reproductive processes. *Mar. Ecol. Prog. Ser.* **190**, 253–262.
- Tarling, G. A., Shreeve, R. S., Hirst, Atkinson A., Pond, D. W., Murphy, E. J., and Watkins, J. L. (2006). Natural growth rates in Antarctic krill (*Euphausia superba*): I. Improving methodology and predicting intermolt period. *Limnol. Oceanogr.* **51**, 959–972.
- Teschke, M., Kawaguchi, S., and Meyer, B. (2008). Effects of simulated light regimes on maturity and body composition of Antarctic krill. *Euphausia superba. Mar. Biol.* **154**, 315–324.
- Thomas, P. G., and Ikeda, T. (1987). Sexual regression, shrinkage, re-maturation and growth of spent female *Euphausia superba* in the laboratory. *Mar. Biol.* **95**, 357–363.
- Watkins, J. L., Buchholz, F., Priddle, J., Morris, D. J., and Ricketts, C. (1992). Variation in reproductive status of Antarctic krill swarms; evidence for a size-related sorting mechanism? *Mar. Ecol. Prog. Ser.* **82**, 163–174.
- Wiborg, K. F. (1971). Investigations of the euphausiids in some fjords on the west coast of Norway in 1966–1969. *Fisk. Dir. Skr. Ser. HavUnders.* **16**, 10–35.
- Zane, L., Ostellari, L., Maccatrozzo, L., Bargelloni, L., Cuzin-Roudy, J., Buchholz, F., and Patarnello, T. (2000). Genetic differentiation in a pelagic crustacean (*Meganyctiphanes norvegica*, Euphausiacea), from the North East Atlantic and the Mediterranean Sea. *Mar. Biol.* **136**, 191–199.