

**Scientific Cruise Reports of
Arctic Expeditions ARK IV/1, 2 & 3**

**Wissenschaftliche Fahrtberichte
der Arktis-Expeditionen ARK IV/1, 2, & 3**

Compiled by G. Krause, J. Meincke & J. Thiede

CONTENTS	Page
Leg 1 (Bremerhaven-Longyearbyen)	
Scientific background	4
Cruise report ARK IV/1 (Bremerhaven-Longyearbyen)	5
The measurement strategy of the expedition	5
1. Physical oceanography	9
2. Remote sensing	12
3. Plankton dynamics	12
4. Passive microwave remote sensing of ice, sea state and atmosphere	13
5. Optical properties and pigments	28
6. Particle distribution	31
7. Distribution of anorganic nutrients	32
8. Vertical distribution of phytoplankton biomass copepod grazing and secondary production	32
9. Plankton communities	33
10. Biological oceanography (phytoplankton)	38
11. Microbiology	41
12. Atmospheric ozone profiles	43
13. Bathymetric surveys	43
Notation of the sections in the East and West Box	47
Station list	48
Leg 2 (Longyearbyen-Tromsø)	
General cruise description ARK IV/2	65
2. Report of the scientific groups	66
2.1 Physical oceanography	66
2.2 Sea ice morphology and transport	67
2.3 Passive microwave remote sensing of ice, sea state and atmosphere	67
2.4 Sea-ice coring	67
2.5 Ozone profiling	68
2.6 Anorganic nutrients	68
2.7 Bacteria	69
2.8 Biological oceanography - phytoplankton	69
2.9 Biological oceanography - plankton communities and ecosystem dynamics	70
2.10 Biological oceanography - food chain dynamics	72
2.11 Biological oceanography - particle series in relation to water masses	72
2.12 Biological oceanography - macrozooplankton	72
2.13 Biological oceanography - feeding biology of dinophytes	73
List of figures	74
List of Tables	80

Leg 3 (Tromsø - Hamburg)	90
3.1 Summary of important scientific observations	90
3.2 Bericht über den Expeditionsverlauf	94
3.3 Danksagung	115
3.4 Stationsliste	117
3.5 Liste der im Text verwendeten Abkürzungen	133
3.6 Arbeitsgruppen / Working Groups	134
3.7 Programm der "Polar University"	135
Participating Institutions ARK IV/1 - 3	137
Participants ARK IV/1	141
Participants ARK IV/2	142
Participants ARK IV/3	143
Ship's Crew ARK IV/1 - 3	144

CRUISE REPORT ARK IV/1

13.05. - 09.06.1987

Scientific background

Previous biological studies in the Greenland Sea during MIZEX 1983 and 1984 revealed a close relationship between biological production and physical-oceanographic processes. Four different regimes have been specified, namely

- the pack ice zone, with a low production due to limited light availability nearly throughout of the entire year,
- the polynya on the East Greenland Shelf, with a strong biological, hydrodynamical and thermodynamical activity,
- the East Greenland Polar Front and the Arctic Front, where frontal processes and oceanographic eddies may transport nutrients to the mixed layer and thus support a strong biological production,
- the central Greenland Sea Gyre with its seasonal destruction of the vertical stratification forms a nearly closed biological system.

The measurements of this cruise leg have contributed to the studies of the biological-physical coupling within these regions. Due to the scale of the processes involved a rather narrow sampling grid was required. Results of such limited investigations may nevertheless be generalized when the processes involved are fairly well understood. Remote sensing, temperature and ocean colour sensors mounted on airplanes and satellites, will provide a basis for extrapolation of our findings to larger scales.

Within an integrated biological-physical programme the two main frontal systems in the Greenland Sea, the East Greenland Polar Front and the Arctic Front, have been studied extensively at the latitude of about 78° N and 76° N respectively. These frontal systems exist permanently. They are of extreme importance to the biological production in the Greenland Sea due to their lateral extension over several hundred kilometers. The high biological productivity in these regions may result from nutrient injections into the euphotic zone through upwelling, lateral advection and eddies.

A dense station grid at the two fronts (fig. 1 and fig. 2) enabled us to resolve the meso-scale features in detail. In addition to the mapping of physical, chemical and biological parameters the main interest was the pelagic energy transfer, especially the nutrient flux, the primary and secondary production and the nutrient regeneration.

Independently of these investigations "Polarstern" carried a newly developed Ozone-LIDAR to measure vertical ozone profiles in the higher atmosphere also during daylight. This new instrument performed very well during periods of low cloud coverage.

Finally the bathymetric survey of the Fram Strait started during recent years has been extended by measurements in the box displayed in fig. 3.

Cruise Report (G. Krause, AWI, chief scientist)

"Polarstern" left Bremerhaven late in the night of May 13, 1987. After a short call at the port of Stavanger and some test measurements work at the Arctic Front was started with an XBT survey on May 19, 1987.

The front was found immediately, and it turned out that it could easily be detected by measurements of temperature and salinity by sensors in the hydrographic well of the ship. Based on these measurements most of the stations for biological work were determined. On May 21, 87 the first overflight of the aircraft "Polar-2" took place with simultaneous optical measurements for ground-truth verification.

On May 24/25, 87 a set of 11 Omega drifters was put in the Arctic Front. The positions of the buoys were determined from board at hourly intervals for a period of 26 hours. The last section in the East box was completed on May 27, and extended towards 20 West.

Work in the West box was resumed on the following day. Ice conditions caused no real problem throughout the expedition.

On June 4, 87 the measurements in the West box were completed. The numbers of sections in both boxes with geographical co-ordinates of end points are listed in table 1 (see also fig. 1 and fig. 2).

The first leg of the expedition ended in Longyearbyen in the morning of June 9, 1987 after extensive seabeam measurements in the area indicated in fig. 3.

The measurement strategy of the expedition

One of the most demanding tasks of the expedition was to find out whether specific physical processes (e. g. upwelling, downwelling) at the Arctic and Polar fronts contribute to the high biological production in the area of investigation.

Although the mean location of these large fronts is predominantly determined by the bottom topography and hence well-known, the actual position is variable due to meandering and eddy formation.

Originally it was intended to chart the fronts' positions by the colour radiometer carried by the aircraft "Polar-2" and to direct the ship according to the remote sensing results. In practice, however, this plan failed due to the very variable flight conditions in the area, which caused remote sensing to lag behind the ship measurements. Therefore it was necessary to develop a very flexible plan for data collection by the ship. Far from the fronts, distances between 10 to 25 nm were chosen between the stations. Within the frontal zone stations were selected on the basis of surface (10 m) recordings of temperature and salinity. Characteristic distances varied between 2 and 5 nm.

Biological samples at depths were taken on the basis of fluorescence and Secchi disk measurements.

Water samples for nutrient analyses were taken at the same depths and additionally down to 500 m at standard depths.

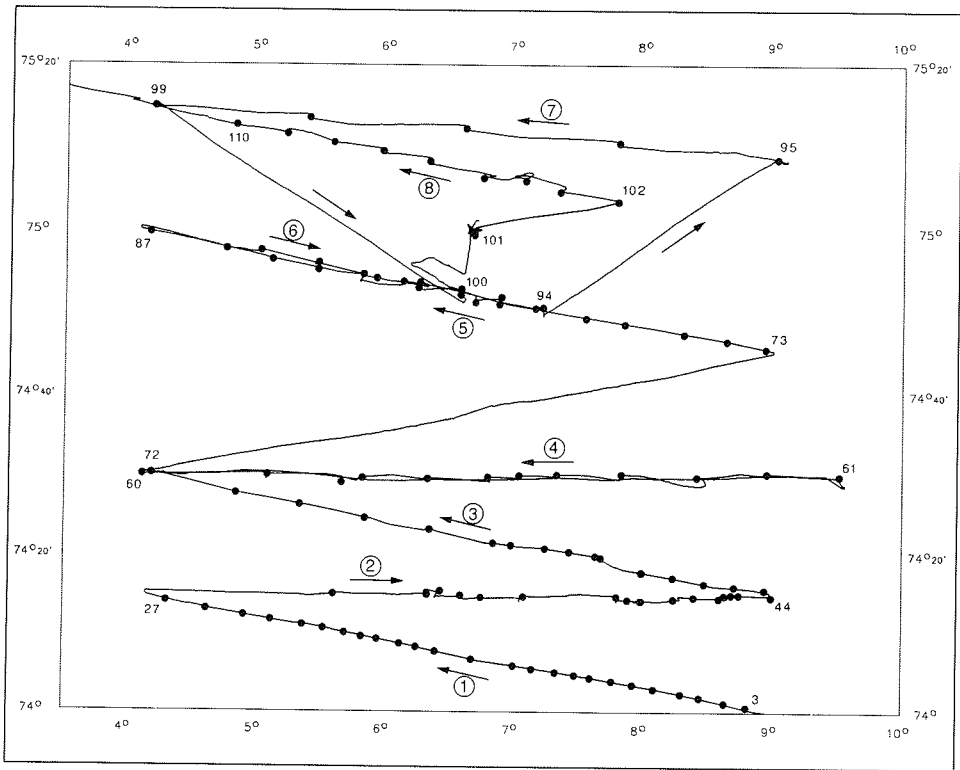

Fig. 1 Sections across the Arctic Front (East Box)

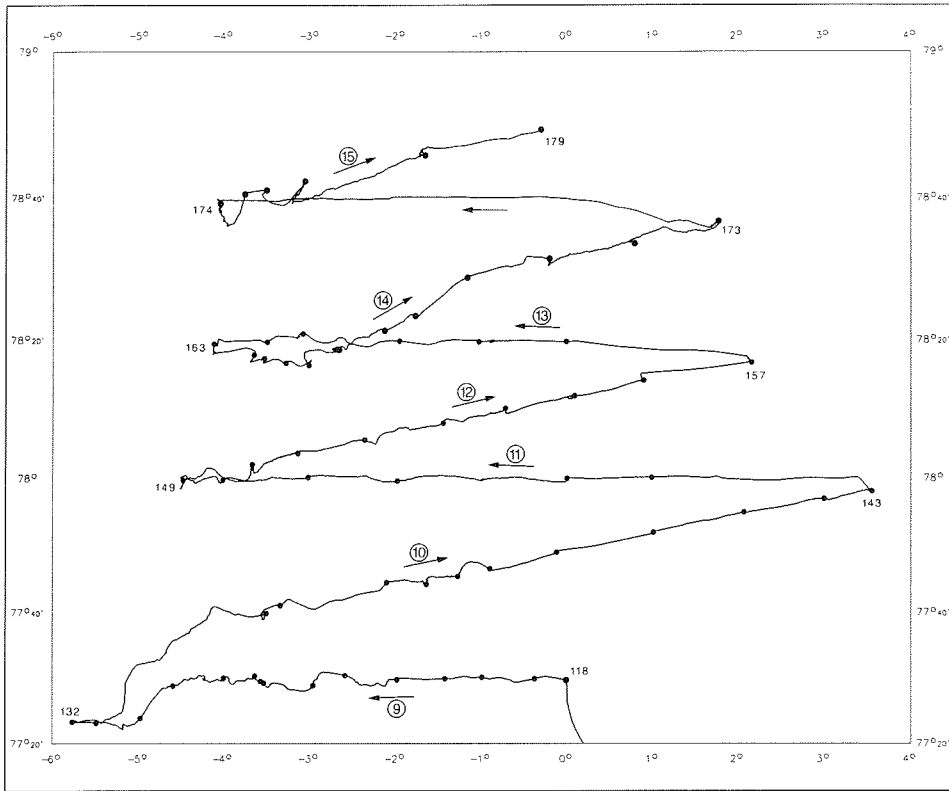
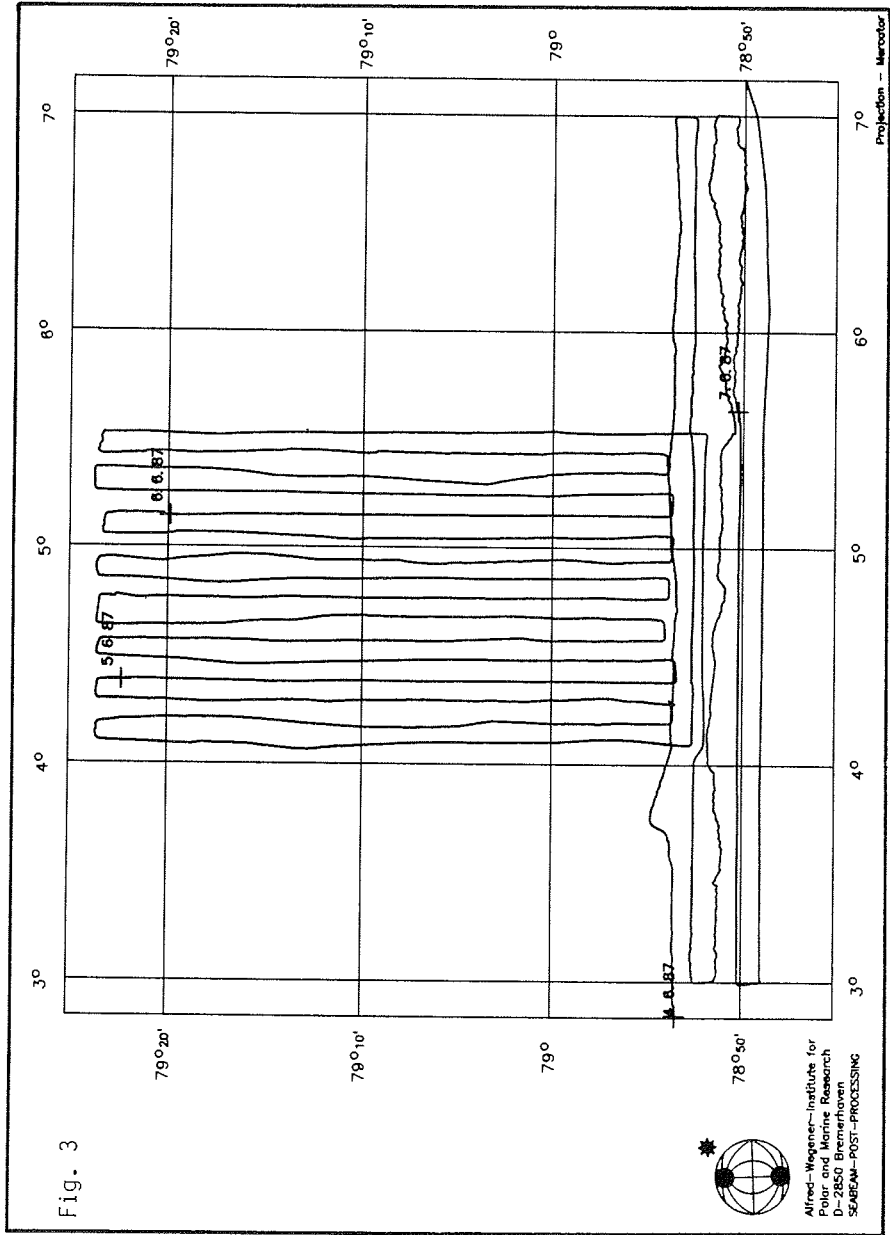

Fig. 2 Sections across the Polar Front (West Box)



1.) Physical Oceanography

Participants: G. Krause (AWI)
G. Budéus (AWI)
Hadikusumah (AWI)
R. Plugge (AWI)
W. Schneider (AWI)
M. Walter (AWI)
J. Launiainen (UNI Helsinki)

The oceanography group performed measurements to locate the fronts and to reveal their physical structure. The following devices were operated:

- XBT
- CTD
- Doppler Sonar Sounder
- Surface recordings of temperature, salinity and turbidity
- Drifter buoys traced via Omega System

The measurements were used directly to select the sections and stations for the biological programme.

XBT

Several XBT transects were done using the XBT Deep Sea Version which measures down to 900 m depth. They were mainly used for online information about the location and the vertical structure of the fronts.

CTD

Two versions of CTDs (Neil Brown and HDW) were installed in the two water sampling rosettes of the AWI.

After initial difficulties the down casts of the Neil Brown sonde provided online information (printout and plot) in engineering units for the biological party. The raw data were recorded on magnetic tape. The audio signals were recorded on an analog back-up tape. During the upcast water samples were taken, and the in-situ CTD measurements plus related physical properties were distributed on a water sample sheet.

For detailed analysis of the CTD data further processing regarding calibration, smoothing and monotonizing needs to be done.

Doppler Sonar Sounder

The Ametek Doppler Sonar Sounder, installed in the ships well, was used to measure the depth resolved relative current velocity below the "POLARSTERN". It was only switched off when entering the ice-covered area and therefore provides data of the East Box and the transect towards the West Box. The ship's movements require extensive processing of the data, preferably using GPS recordings of the ship's position.

Surface recordings

The basket in the ship's well was modified to hold additionally instruments recording temperature, salinity and turbidity in a depth of approximately 10 m. These measurements were plotted versus time by a multichannel penwriter for online information in a laboratory next to the bridge. Based on the recordings the ship could immediately be directed to interesting stations within the frontal structures.

Drifter Buoys

In the East Box a drifter experiment was carried out over a period of 26 hours. The surface drifters were equipped with Omega radiosondes which allow the determination of their movement relative to the ship by the Vaisala Digicora system. 11 drifters were traced in an hourly interval. Since the ship's path is rather complex during the time of observation, correction of the obtained data with respect to the ship's movement is necessary.

Geostrophic calculations

Preliminary geostrophic calculations were performed based on the CTD-data. The level of no motion was assumed at 2000 m depth. The results were found in reasonable agreement with the general circulation in the Greenland Sea. The largest velocities were calculated near the Arctic front, and the total volume transport through a cross section at 75°10' N through the East Box resulted in 5,5 SV.

Air-sea interaction studies

The air-sea interaction was studied using the marine meteorological observations made by the ship. Because of the ship data are recorded by an automatic weather station primarily for daily routine weather surveys, much attention was paid to the calibration of the data. More than 90 comparisons were made, especially for getting the air temperature and humidity measurements as reliable as possible.

The air-sea fluxes and stratification characteristics were calculated with the bulk aerodynamic method in which the atmospheric surface layer stability was taken into account in terms of the Monin-Obukhov Length, in an iteration solution using universal functions.

Like the weather in the area, the fluxes and air-sea exchange characteristics were found to vary distinctly in space and time. Overcrossings of the sea front were of special interest. An example is given in Fig. 1.1. When crossing the sea front from warm water to cold water, the atmospheric surface layer stratification (z/L) became very stable, the evaporation i. e. the latent heat flux (E) was changed in direction and the sensible heat flux (H) was from air to sea (it had been upwards before). The distinct increase of stability changes also the flux of momentum. This change, especially during the light and moderate winds, is expected in many cases to be significant enough e. g. to affect the local field of wind waves and thus to make the frontal zone more detectable e. g. by some of the remote sensing techniques.

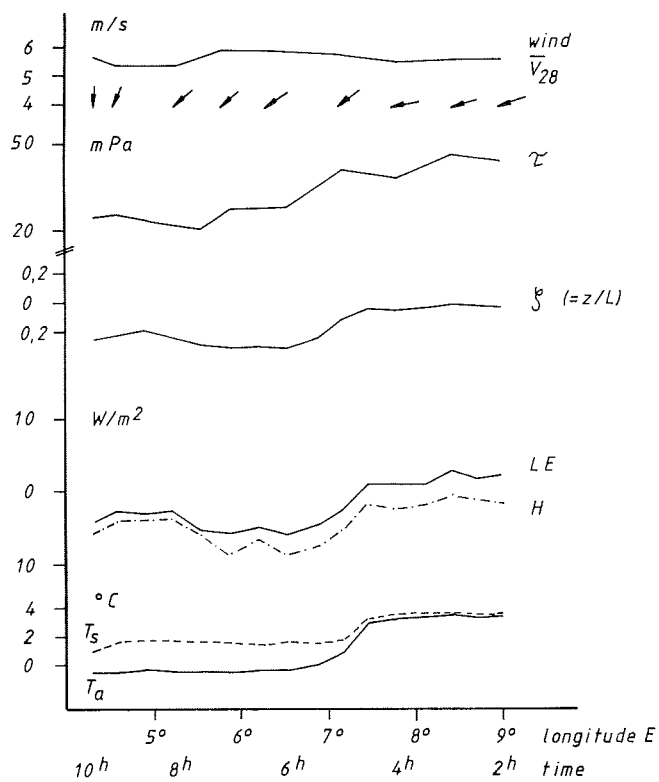

Fig. 1.1 Meteorological parameters as recorded during a passage of the Arctic front from warm to cold water. V_{28} = wind speed; τ = wind stress; ζ = stratification parameter; LE = latent heat flux, H = sensible heat flux; T_s = water temperature, T_a = air temperature

2.) Remote Sensing (AWI, Aerodata, Visibility Lab.)

Remote sensing data, both airborne and from satellite were acquired during the study period to assist in describing the synoptic mesoscale and large scale variability along the frontal features.

On six days between May 21, and June 2, 1987 the Polar-2 was overflying a track similar to the ship's grid at low altitude to acquire trackline distributions of upwelled radiance at 10 wavelengths using the Visibility Laboratory's Multispectral Airborne Radiometer System (MARS). MARS is a lightweight radiometer designed to be flown in aircraft of opportunity. It views the surface at or near nadir through a lens attached to an integrating sphere, the interior of which is viewed by 10 filtered detectors. Data from the 10 down-looking radiance channels, and from 3 up-looking irradiance detectors, is logged by a laptop personal computer. Coincidentally with the MARS overflights optical measurements were made of the upwelling spectral water-leaving radiance. This will be used to calibrate the MARS data and the development of appropriate algorithms.

Satellite images (AVHRR) for the study period were acquired from the satellite receiving station in Dundee, Scotland. These images will be processed into sea surface temperature imagery.

3.) Phytoplankton dynamics

Graduate Program in Ecology, University of Tennessee, Knoxville

Participants: Nancy Keene
Mary Culver
Lisa Creasman

The primary interests of the research group were those of phytoplankton dynamics. To pursue these interests several experiments and measurements were performed dealing with phytoplankton in the Greenland Sea Ammonium and nitrate uptake, ammonium regeneration, particulate carbon, hydrogen, silica and nitrogen, phytoplankton sinking rates and photosynthesis versus irradiance curves were all determined at various stations in both the eastern and western boxes of the cruise. Uptake rates and particulate carbon, hydrogen and nitrogen were determined at six light depths at each of thirty-four stations. These measurements were also done at single depths at additional thirteen stations. Regeneration experiments were done at two depths at fifteen of the thirty-four stations. Samples for particulate silica were taken at twenty one stations. Photo-synthesis versus irradiance curves were done at two depths at two stations in each of the last two transects of the western box. Sinking rates were determined at three depths at each of twenty-seven stations.

The uptake and CHN particulate samples will be taken back to the University of Tennessee where determinations will be made and results calculated. Particulate silica will be determined by David Nelson at the University of Oregon. Data from the photo-synthesis versus irradiance curves will also be taken back for further interpolation. Sinking rate parameters included chlorophyll, particulate carbon, nitrogen and silicate.

4.) Passive Microwave Remote Sensing of Ice, Sea State and Atmosphere

Participants:

Dr. Rene O. Ramseier (AES, York University, Canada)
Ken W. Asmus ("")
Caren Garrity ("")
Christine König (DFVLR)

Objectives

The three original objectives were as follows:

1. To validate the Special Sensor Microwave/Imager (SSM/I) on a polar orbiting satellite of the Defence Meteorological Satellite Program (DMSP).
2. To provide near real time (less than 3 hours after satellite overpass) ice information to Polarstern's operation in ice-frequented waters as an operational demonstration experiment to validate a new algorithm for use with the SSM/I.
3. To collect in-situ 37 GHz dual polarized brightness temperatures as the Polarstern traverses through ice-frequented waters and while anchored to a floe. In the latter case, detailed surface measurements of snow and ice properties are contemplated.

Objectives 1 and 2 could not be realized as part of ARK IV/1 due to a delay in the launch of the Defense Meteorological Satellite. The launch has been rescheduled for June 16, with the turn on of the Special Sensor Microwave/Imager 7 days later on June 23.

Objective 3 was fully accomplished. Eight legs were made in the Western box which contained ice. The overall average ice concentration was about 50 %. We were able to occupy 7 ice stations where we have coincidental data with the 37 GHz passive microwave radiometer (PMR) and the Resometer. The Resometer permits us to determine the amount of free water in the snow overlying the ice.

Since a significant amount of time was spent in ice-free areas, we augmented our program with PMR measurements of the ice free ocean surface. Unfortunately for us there were no high wind conditions and consequently the data collected was primarily at low windspeeds. In addition, atmospheric PMR measurements were made during radiosonde launches.

Ice Reconnaissance

Due to a strong interest expressed by Dr. H. J. Hirche in obtaining some ice distribution information, a number of additional observations were obtained. A total of 8 flights with the helicopter were made covering the ice-covered legs the FS "Polarstern" had to go through. This provided information on the ice conditions and helped in planning of the experiments. Since the ice conditions were rather easy for a ship like the "Polarstern" to handle, no significant ice navigation problems were encountered. Figures 4.1-4.7 provide the general ice information gathered with the helicopter. Table 4.1 provides the dates and times of these flights.

Additional ice observations were made from a shipboard position next to the meteorological office. An example of this data for leg. 1 is shown in Figure 4.8. The data is presented in the form of a bar graph with an ice concentration average for every 2 nautical miles.

KEY TO ICE SYMBOLS

AMOUNT, STAGE OF DEVELOPMENT, AND FLOE SIZE

14

C_T Total Concentration

$C_a C_b C_c$ Partial concentration of the three thickest types of ice present, thickest first

S_d Code for Stage of Development of the three ice types reported in $C_a C_b C_c$. is ice thicker than S_a but always less than 1/10 concentration

S_o is a fourth stage of development present after $S_a S_b S_c$ or the predominant type remaining if more than four stages are present

Form of Ice

0 Pancake

1 Brush

2 Ice cakes (<20 m)

3 Small floe (20-100 m)

4 Medium floe (100-500 m)

5 Big floe (500-2000 m)

6 Vast floe (2-10 km)

7 Giant floe (>10 km)

8 Fast ice

9 Icebergs

NC Ice is in strips in which concentration is C. Overall concentration C_T averages both the strips and the dispersed area between them.

Stage of Development (Age)

1 New Ice

2 Milas

4 Grey ice

5 Grey-white ice

7 Thin first-year/white ice

1 Medium first-year ice

4 Thick first-year ice

7 Old ice

▲ Icebergs

OTHER FEATURES

- Crack (general)
- Crack in a specific location
- Lead
- Frozen lead
- Rafting and its extent in tenths
- Ridges/hummocks and extent in tenths
- $\gamma \text{▲▲} \bar{h}/h_e$ Frequency of ridges per n. ml. with mean and extreme height in tenths of metres
- Thickness of ice in centimetres
- Melting

1	Few puddles	6	Dried ice
2	Many puddles	7	Rotten ice
3	Flooded ice	8	Few frozen puddles
4	Few thaw holes	9	All puddles frozen
5	Many thaw holes		
- Undercast
- Limit of visual obs.
- Limit of radar obs.
- Ice edge or boundary by radar obs.
- Ice edge or boundary by visual obs.
- Ice edge or boundary estimated

Similarly, an ice concentration profile was generated from the PMR brightness temperature profiles. This is shown again for leg 1 in the form of a bar graph in Figure 4.8.

In studying these three ice reconnaissance products it is interesting to note the differences in ice concentration due to method used and time of day. There is some correlation between the shipborne visual ice observations as compared to the PMR ice concentration profile. However, one should realize that the ship usually goes around an obstacle if the situation permits rather than through an ice floe. This will automatically produce a lower ice concentration since the sensor looks at a spot 25 metres from the port side of the ship.

Ice Stations

A total of 7 stations were occupied. Coincident data was obtained with the PMR and the Resometer. Small snow pits were dug all the way down to the ice surface. Dielectric measurements of the snow were done at various depths and densities were determined at these depths. From these measurements, the amount of free water was calculated. Table 4.2 gives the date of collection and the ice type. First Year (FY) or Multi Year (MY). The snow depth at the location of measurement is also given followed by the range of amount of free water (FW) in the snow.

Additional snow pits were dug, usually in a circle, to obtain a better average of the snow depth and characteristics. A total of 42 snow pits were studied of which 11 had dielectric measurements made and density determined. In addition the following parameters were measured or observed as indicated in Table 4.3.

Table 4.1

Helicopter Ice Reconnaissance Missions			
28 May 1987	1053-1123	0.5 hrs	Figure 4.1
30 May 1987	1905-2014	1.2 hrs	Figure 4.2
31 May 1987	0702-0824	1.4 hrs	Figure 4.3
01 June 1987	1317-1428	1.0 hrs	Figure 4.4
01 June 1987	1730-1830	1.2 hrs	Figure 4.5
02 June 1987	0919-0951	0.5 hrs	Figure 4.6
02 June 1987	1352-1415	0.4 hrs	Figure 4.6
03 June 1987	0820-0922	1.0 hrs	Figure 4.7

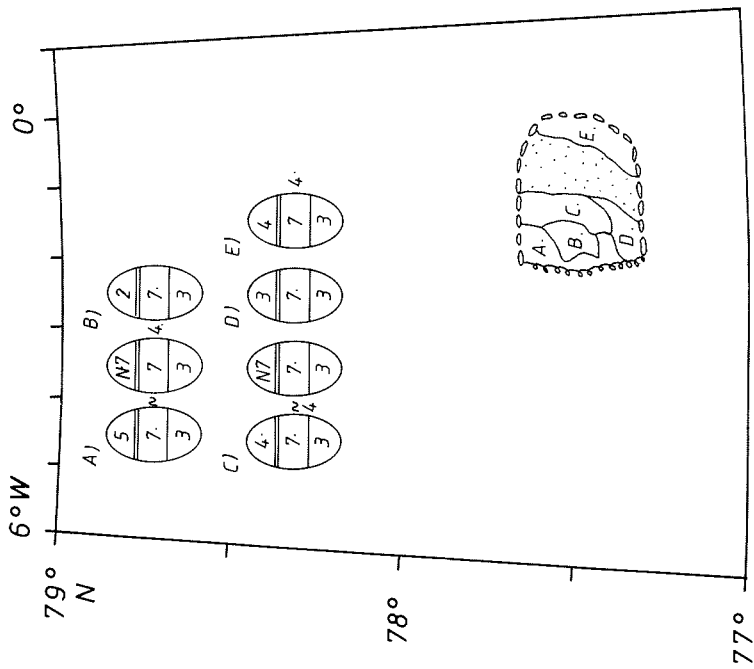

28. May 1987
10.53 - 11.23

Fig. 4.1 Ice Distributions

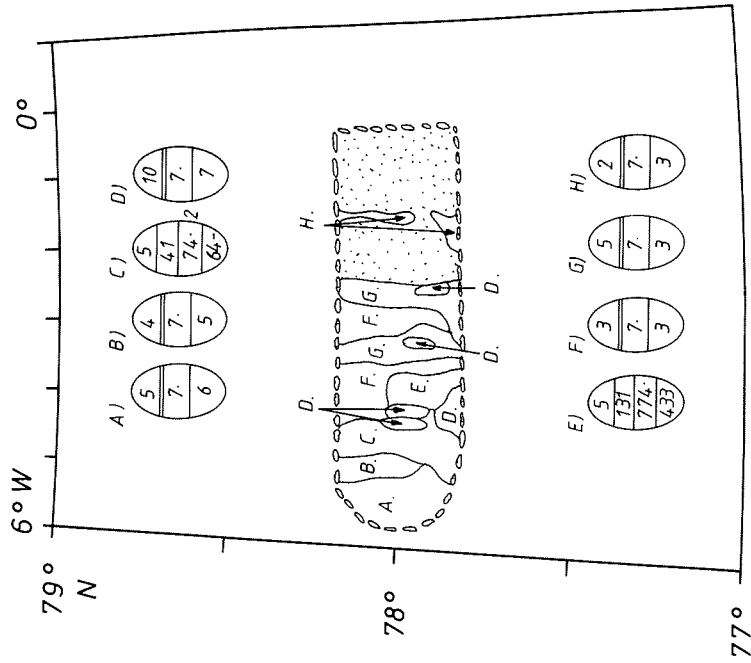

30. May 1987
19.05 - 20.14

Fig. 4.2 Ice Distributions

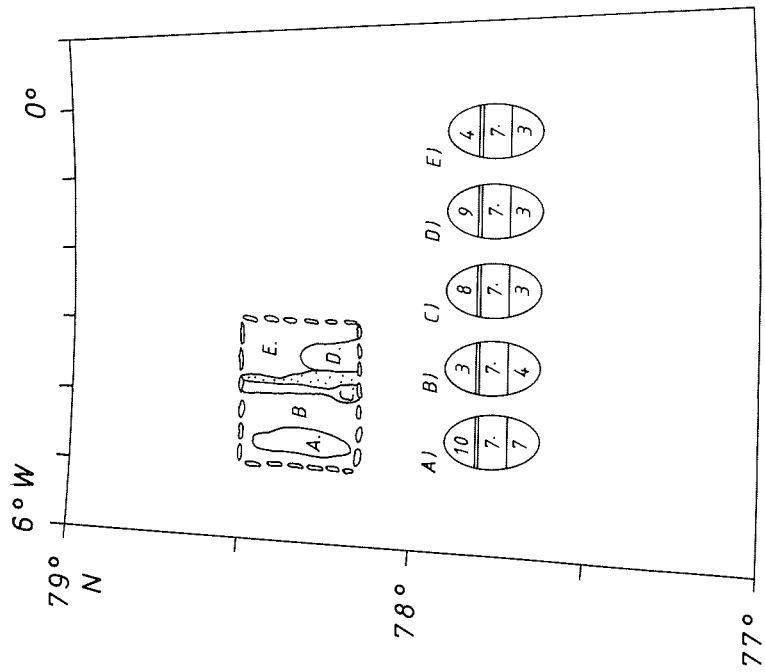

01. June 1987
17.30 - 18.30

Fig. 4.5 Ice Distributions

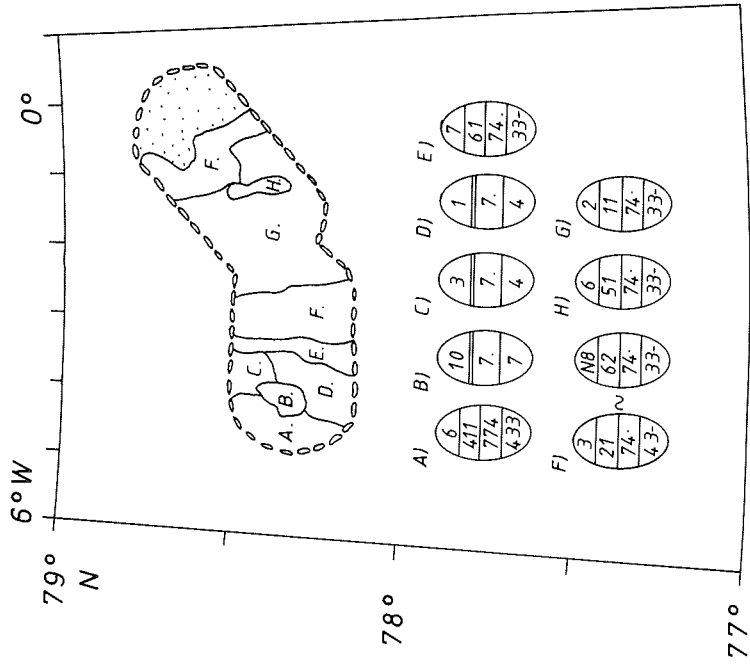

02. June 1987
09.19 - 13.52

Fig. 4.6 Ice Distributions

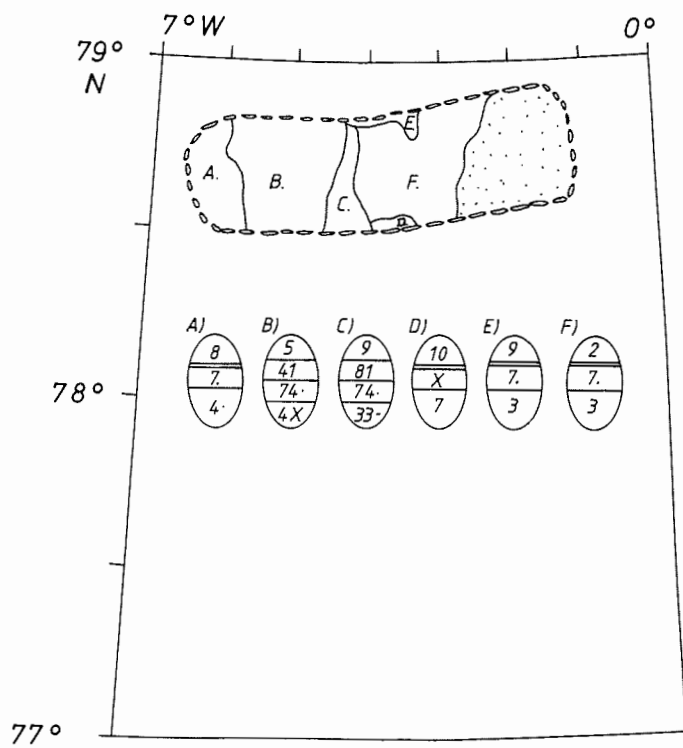

03. June 1987

08.20 - 09.22

Fig. 4.7 Ice Distributions

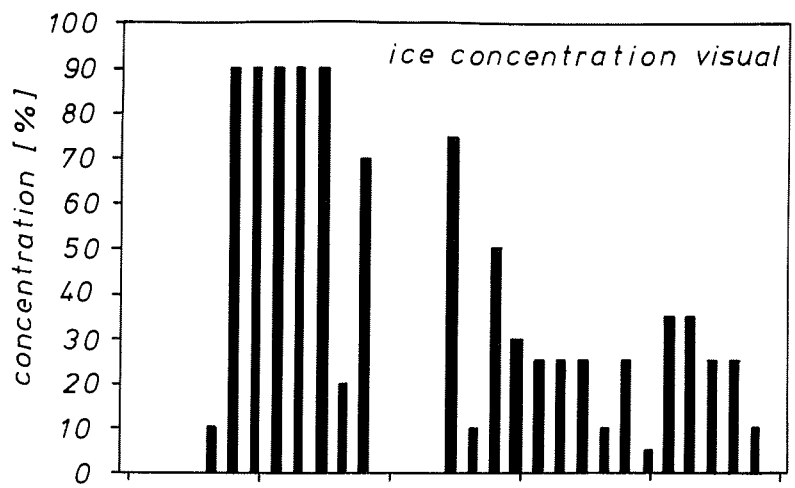

Fig. 4.8

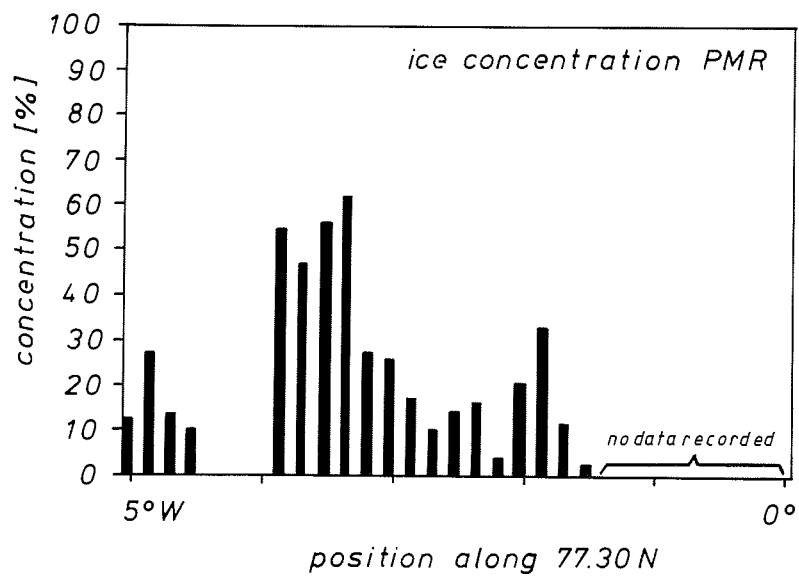

Fig. 4.9 01 JUN 1987 ICE STATION 4MY

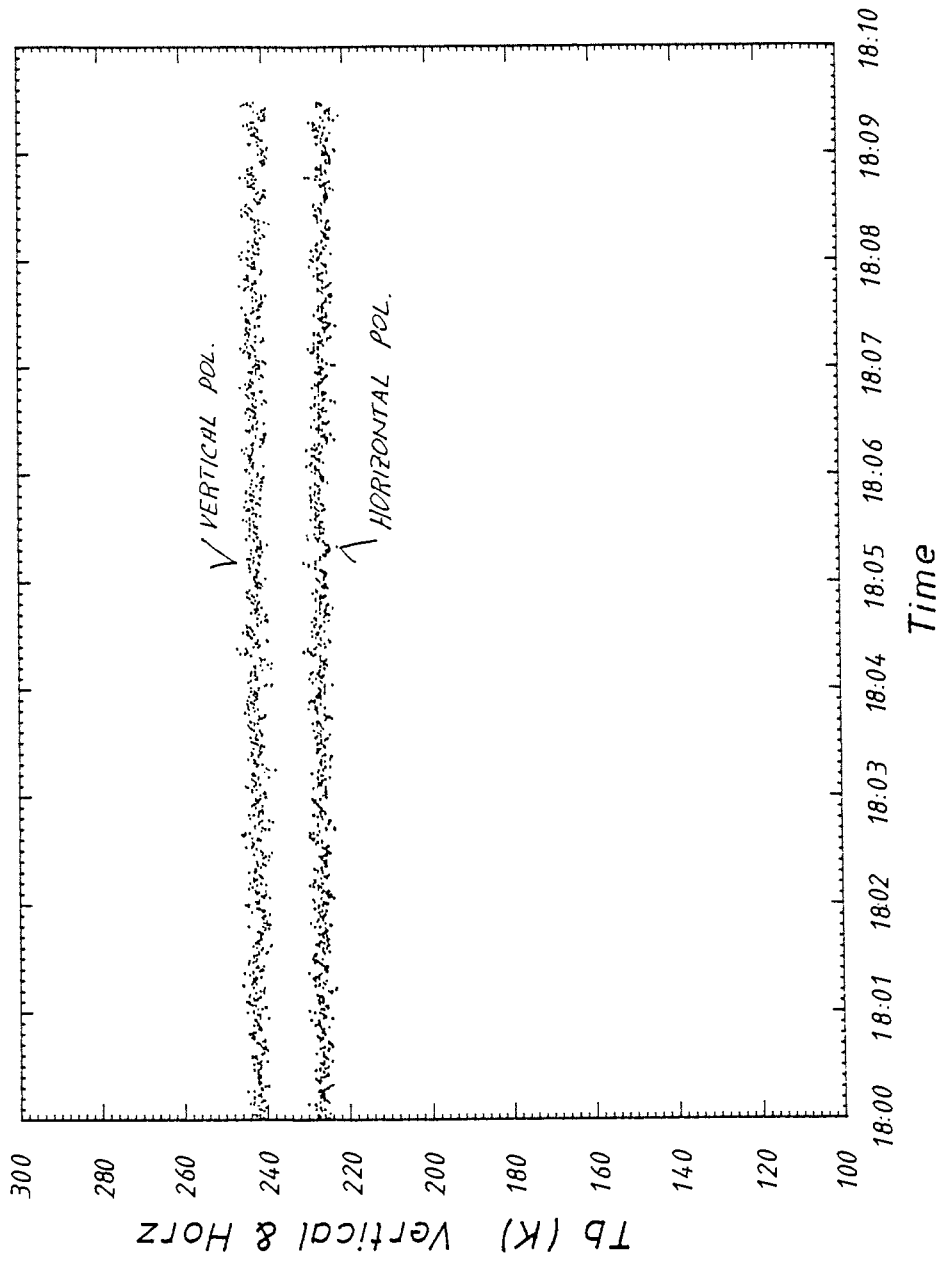

Fig. 4.10 03 JUN 1987 ICE STATION / FY

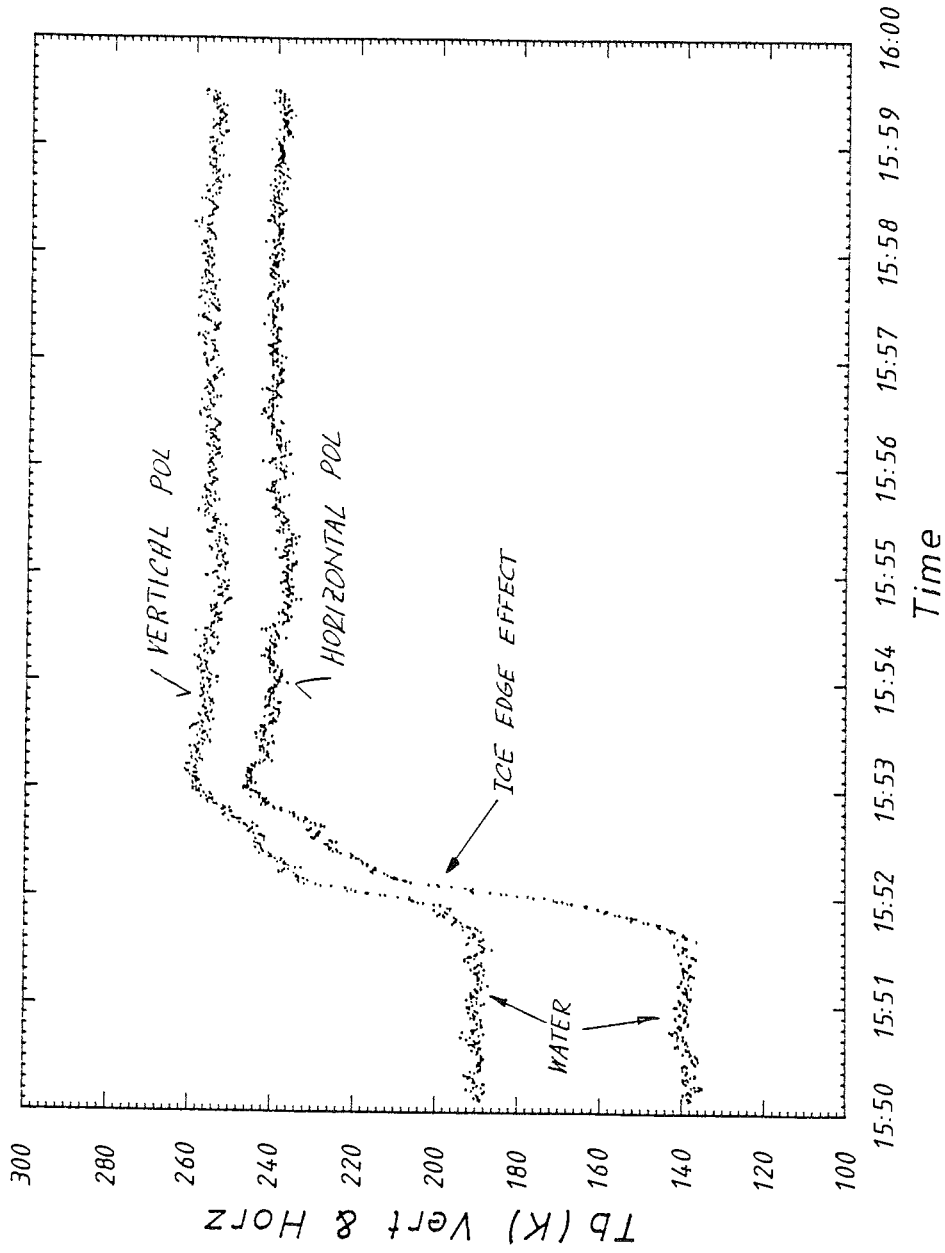

Fig. 4.11 03 JUN 1987 GREY ICE NEAR STATION 6

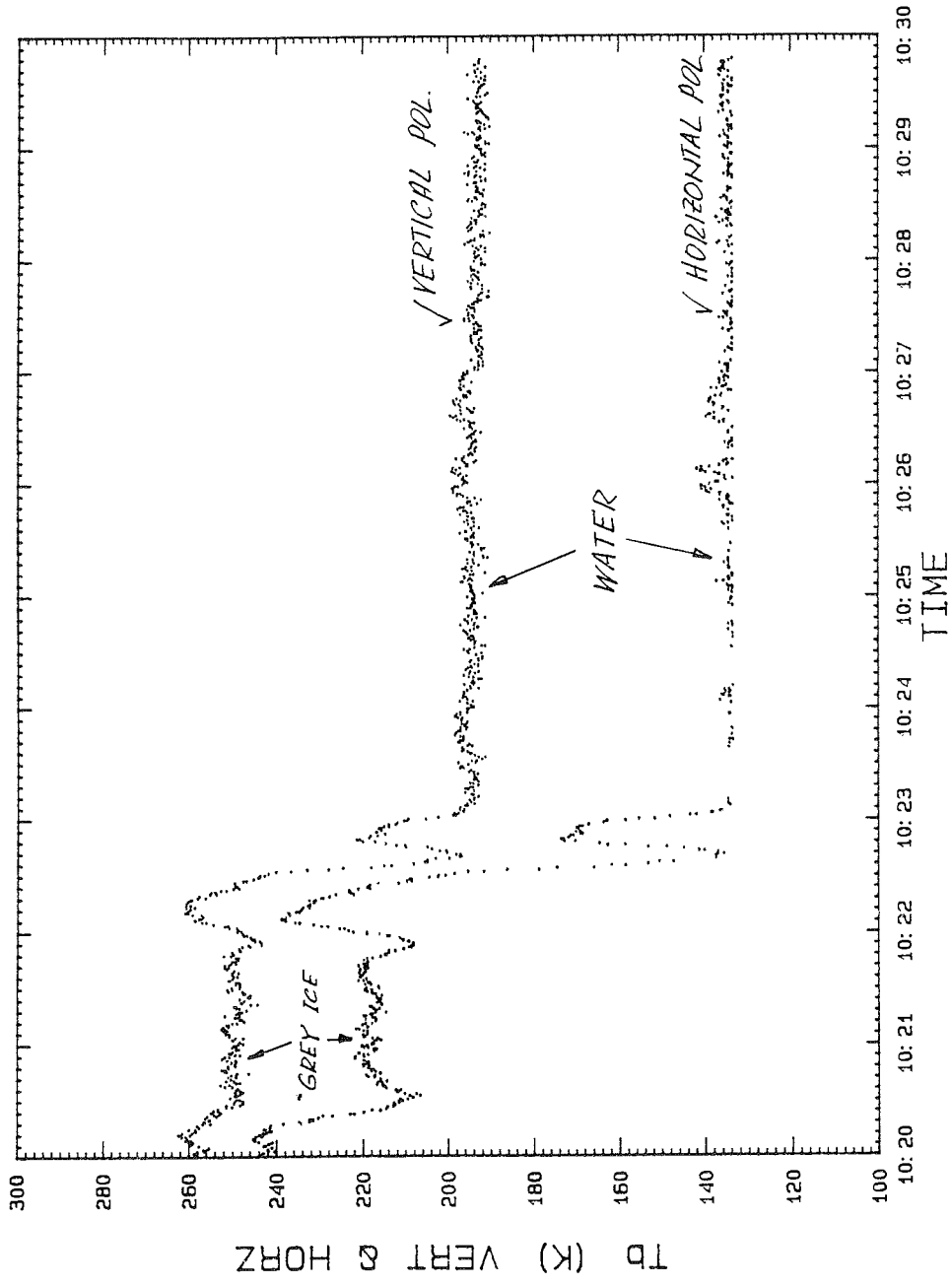
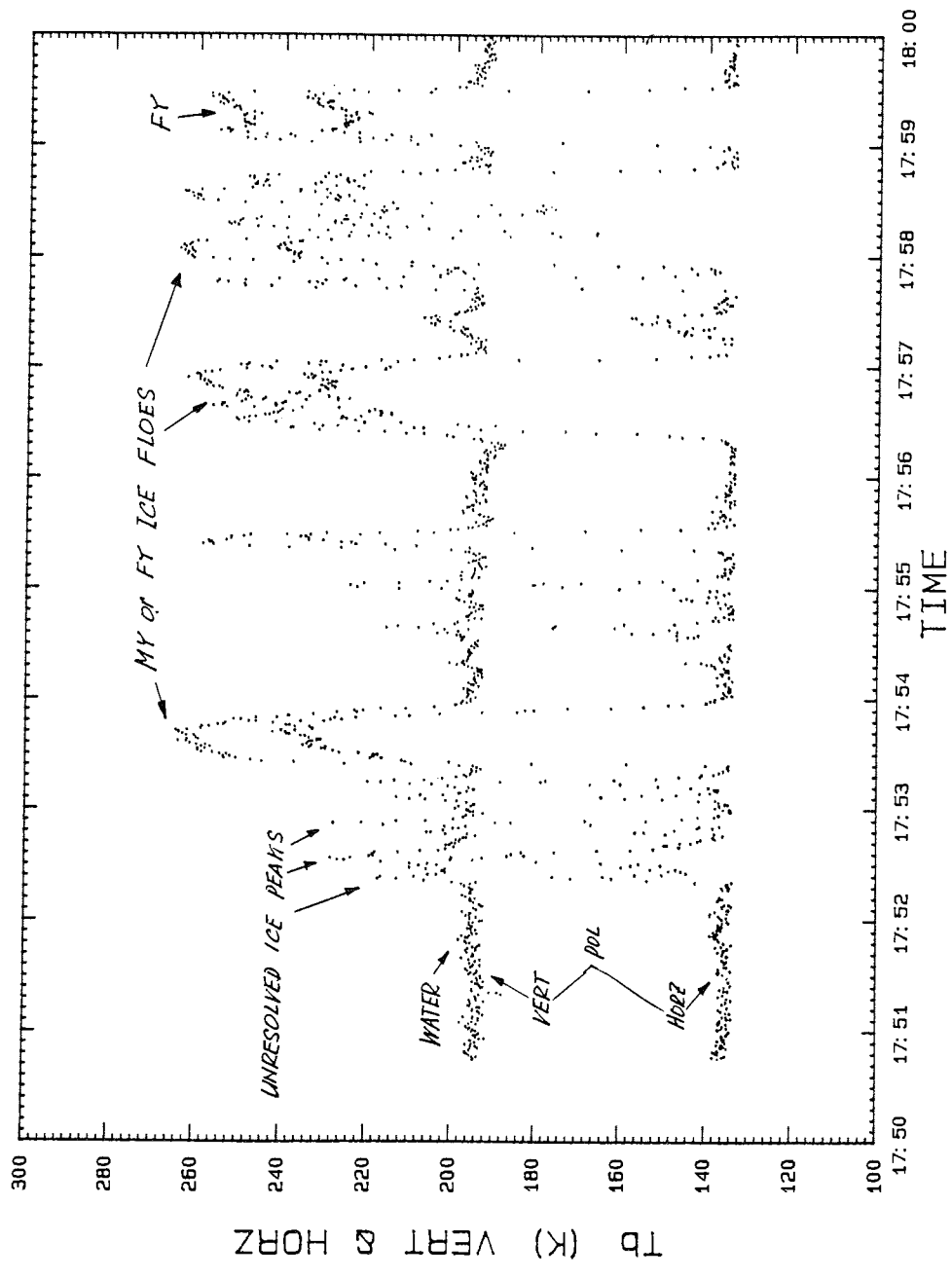

Fig. 4.12 28 MAY 1987 ICE - WATER PROFILE



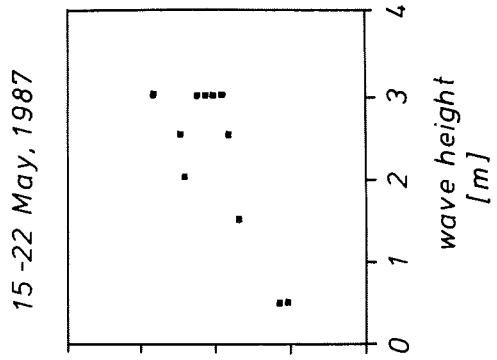

Fig. 4.14

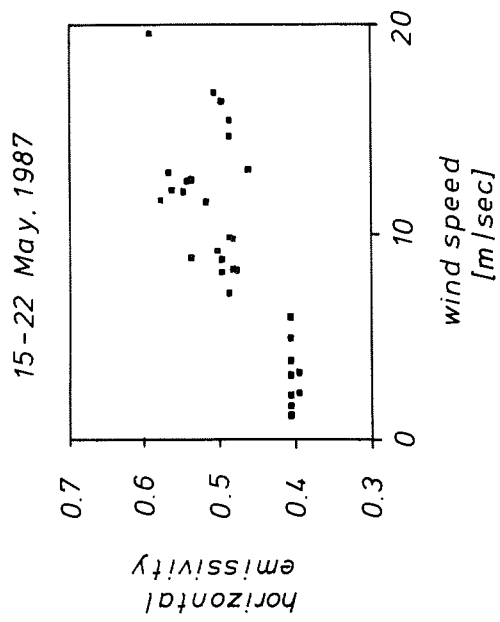

Fig. 4.13

Passive Microwave Data

As mentioned above, at each station, measurements were made with the ship mounted PMR viewing the surface at an incidence angle of 53 degrees. The spot on the surface as seen by the radiometer was in the form of an ellipse 5.79 m x 3.47 m in size. An example of multi year ice signatures is given in Figure 4.9 taken at station 4. The data set consists of 1000 points for each polarization of vertical and horizontal. The mean brightness temperature T_b is 242 for the vertical and 226 for the horizontal polarization respectively. The polarization difference amounts to 16 deg K. Similarly, an example of first year ice taken at Station 7 is shown in Figure 4.10. In this case the lower T_b at the beginning of the 10 minute run shows how the ship approached the ice sideways showing clearly the transition from water to the FY ice. Finally Figure 4.11 gives an example of Grey Ice (approx. 15 cm thick) near station 6, followed by open water.

Usually 10 minute T_b profiles were taken continuously when the ship was under way. A typical profile is shown (Figure 4.12) for 28 May 1987 from 1750 to 1800. The lower T_b 's represent water while the peaks indicate the presence of FY or MY ice. Small peaks usually indicate unresolvable small floes giving a mixture of ice and water. Shipborne observations were taken when an ice floe was within the full view of the PMR beam and identified as to the type of ice, surface conditions and amount of snow cover, when possible. With the station plots discussed above, these 10 minute plots provide the basis for obtaining a good statistical signature range for different ice types and conditions. We have collected a total of 20 Megabytes of PMR ice data.

Ocean Measurements

As mentioned earlier some ocean surface measurements were taken in the Eastern Box and during transits starting from Stavanger. Some results are shown in Figure 4.13 showing the wind speed dependence of the PMR horizontal channel. It is interesting to note the change in response to foam build up at the higher wind speeds around 7 m/sec. In this case windspeeds as measured by the ship have not been corrected to surface values. The PMR had an incidence angle of 65 degrees.

Similarly a correlation was made with wave height as determined by the Met Office personnel, for the horizontal polarization (Figure 4.14). Unfortunately, we did not experience any serious weather. Twenty megabytes of data have been collected here.

Atmospheric Measurements

As mentioned in the introduction, the PMR was put into a vertical position to view the sky during the ascent of radiosondes. A total of 9 measurements were made. Excellent correlation was obtained in six cases by calculating the total amount of precipitable water in the atmospheric column. From this value, using a simple expression, the T_b was calculated based on the radiosonde data and compared with the T_b measured by the radiometer. In 2 out of the 9 cases extensive water deposit on the protective cover of the antenna gave erroneous results and in one case, from condensation dropping into the throat of the horn caused false results. A total of 5 megabytes of data was collected.

Conclusions

In general the program went very well. Some serious problems occurred when the equipment was installed. Due to power spikes we lost two power supplies, one on an IBM PC/AT computer and one on our Radiometer Tracker. Fortunately we had a back-up computer. The Tracker could not be used but did not impact on the objectives of the

program. The support received by the staff at AWI and on board the ship has been outstanding. This is the second cruise for two members of this team (ROR and KWA) and we are looking forward to ARKTIS IV/2.

Acknowledgements

We would like to thank the personnel of the Alfred-Wegener-Institut for allowing us to sail again with FS "POLARSTERN" and to Mr. R. Krause of AWI for his assistance in getting our equipment on board early and Dr. H. Tüg for solving our power problems before sailing. A special thanks to Prof. Krause, our Expedition Leader for his help and co-operation throughout the cruise, the Captain and the crew of "POLARSTERN", the radio operators and met office staff and to our Field Teams, J. Launiainen, W. Schneider, G. Budéus, D. Douglas and last but not least our Polar Bear watchers G. Edwards, J. Focke and V. Meyer.

Table 4.2

General Ice Station Information				
29 May 1987	MY	.23	M	0
29 May 1987	MY	.35	M	0
31 May 1987	FY	.105	M	0 -.7
01 June 1987	MY	.37	M	1.6 - 3
01 June 1987	FY	.67	M	0 - 1
03 June 1987	FY	.14	M	3 - 1
03 June 1987	FY	.13	M	2

Table 4.3

Station data collected
1. Snow depth
2. Free water content of snow
3. Snow density
4. Temperature near surface and at ice/snow interface
5. Grain size
6. Structure (presence and location of ice layers and crusts)
7. Nature of snow/ice interface (wet, dry, slush)
8. Roughness of snow/ice interface - if possible
9. Surface of roughness on the microscale

5.) Optical Properties and Pigments

(Visibility Laboratory, SIO, La Jolla, U. S. A.)

Participants: Charles C. Trees
Gerald D. Edwards
Leonard Lopez

In our program we were interested in describing the bio-optical processes occurring in frontal and ice edge regions of the Greenland Sea by measuring the apparent and inherent optical properties and the distribution and concentration of the various phytoplankton pigments using high-performance liquid chromatography (HPLC). To facilitate a better understanding of the synoptic scale processes occurring in the survey areas, an aircraft ocean colour sensor, built at the Visibility Laboratory, was flown.

Optical Measurements

Thirty-five optical stations were occupied were downwelling irradiance at 12 wavelengths (410, 441, 488, 507, 520, 532, 550, 589, 633, 656, 671 and 694 nm) and upwelling irradiance and radiance at 8 wavelengths (410, 441, 488, 520, 550, 589, 633 and 671 nm) were measured. The Multichannel Environmental Radiometer (MER) is an optical data acquisition system, which also measures water pressure and temperature. Attached to the MER was a Sea Tech 25cm Transmissometer (665 nm) for measurements of the beam attenuation coefficient. During the vertical profiling with the MER, data from five channel (440, 491, 519, 551 and 669 nm) deck cells were merged to derive the following optical properties as a function of depth and wavelength; the diffuse attenuation coefficient (K), the water reflectance (R), the surface-leaving radiance (LW). The following is a summary of some of the optical data. The model determination is based on the measurement of discrete optical layers and a brief review of the general idea is listed in Figure 5.1.

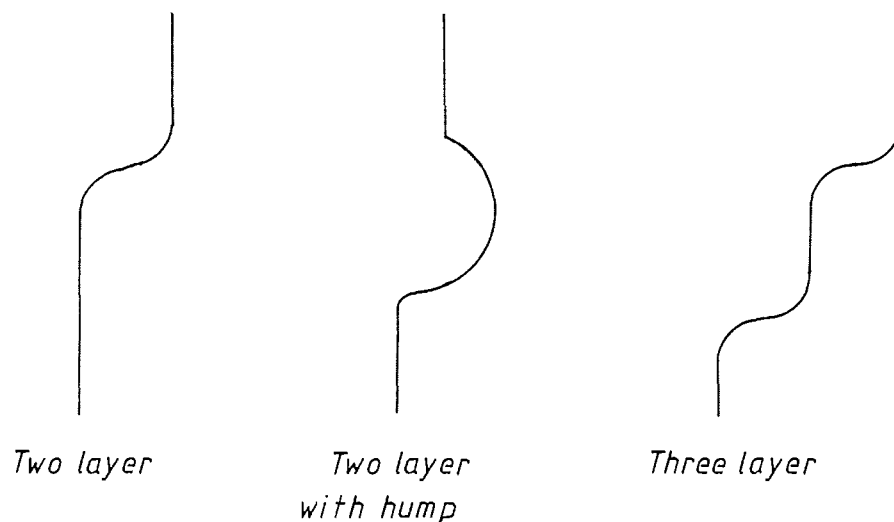

Fig. 5.1 Classification of typical optical profiles.

Station	Model	Ave.K (488) to 100 m (m ⁻¹)
---------	-------	---

28		
30	Two layer with hump	0.0485
31	Two layer with hump	0.0485
61	Two layer	0.0498
63	Two layer	0.0462
65	Two layer	0.0656
66	Two layer	0.0556
67	Two layer	0.0496
90	Two layer	0.0647
91	Two layer	0.0664
*92	Two layer	0.0689
94	Three layer	.0763
101	Two layer with hump	0.0717
103	Two layer with hump	0.0625
105	Two layer with hump	0.0613
107	Three layer	0.0545
113	Single layer	0.0392
117	Two layer	0.0573
132	Two layer	0.0503
133	Two layer	0.0388
*134	Two layer	0.0363
135	Two layer	0.0665
136	Two layer with hump	0.0619
*143	Two layer with hump	0.0560
149	Two layer	0.0493
?	Two layer	0.0753
151	Three layer with hump	0.0724
152	Three layer with hump	0.0749
157	Three layer	0.0749
*159	Three layer with hump	0.0703
168	Three layer	0.0562
*169 A	Two layer	0.0737
171	Two layer	0.0556
177	Three layer	0.0488

* indicates overflights of the Visibility's Lab Multispectral Airborne Radiometer System (MARS).

HPLC Measurements

The HPLC system consists of a Spectra Physics Extended Range Pump which is capable of providing ternary gradients. Included with the pump is a Spectra Physics Organizer Module-Dynamic Mixer with an Rheodyne injection port. The pigments are separated on a C18 column utilizing a Waters Associates Radial Compression Module. As the various pigments are eluted off the column their peaks are measured using a Water Associates Single Channel Absorbance Detector with a 436 nm filter assembly. The output from the detector is recorded on a Spectra Physics Two Channel Computing Integrator with Memory Module, in which up to 256 kilobytes of data can be stored for later retrieval and enhancement, or can be downloaded through an RS-232 port to a personal computer.

Samples were filtered through 0.4 micrometer polyester Nuclepore Filters and extracted in 40 % - 60 % mixture of DMSO and 90 % acetone. Before injection the sample was mixed with an ionpairing solution (tetrabutylammonium acetate and ammonium acetate; Mantoura and Llewellyn, 1983) to facilitate the separation of the dephytolated pigments (chlorophyllide a, phaeophorbide a and chlorophyll c). Pigments were separated on the column using a two solvent system [A-(80:10:10 %; methanol-ion-pairing: distilled water) and B-(100 % methanol)]. Solvent A was pumped for 3 minutes followed by a linear gradient elution from 100 % A to 100 % B in 9 minutes. This is then pumped for an additional 3 minutes.

The following is a list of stations in which HPLC measured pigment distributions were determined at the upper six bottles or light levels.

Stations 28, 29, 30, 31, 32, 34
61, 63, 65, 66, 67, 71
87, 90, 92, 94, 103, 105, 107
113, 115, 117
132, 133, 135, 136, 137, 138, 139, 143
149, 150, 151, 153, 155, 157, 159, 168, 196a, 171, 173, 174, 177,
179

6.) Particle Distributions

(Institute of Thermophysics and Electrophysics (ITE), Estonia)

Participants: M. Kahru
S. Nommann
J. Sildam

During the "Polarstern" expedition ARK IV/1, the group from ITE studied the particle hydrographical structure of the water masses. The measurements were made in the "underway" sampling mode from water that was continuously pumped into the lab from a depth of 6 m. The instrumentation package consisted of an "on-line" particle size analyzer Hiac-Royco PC-320, a Turner Designs flow-through fluorometer, and IBM PC compatible computer/data logger. Horizontal distributions of particles in 12 size classes with the equivalent spherical diameter from 1 to 1000 micrometers and in vivo chlorophyll a fluorescence were obtained on most of the transects. The horizontal space resolution of the measurements was mostly between 200-600 m. The total length of the transects obtained exceeds 700 nm. in the East box. From the same water supply samples were drawn for the analysis of chlorophyll a and other pigments, as well as for the microscopic analysis of phyto- and nanoplankton by other groups. As soon as these data become available, attempt will be made to interpret the particle counts in terms of the dominant plankton groups. Especially valuable should be the samples taken from points of special interest (very high or low concentrations or different structure) that was possible due to the "real-time" operation of the system. These inhomogeneities were mostly missed by the ship's general station grid. The fluorescence will be converted into chlorophyll-a-concentration. From a "quick-look" at the data it is evident that the particle concentrations as measured "on-line" are excellent tracers of the planktonic ecosystem. The distributions were obviously related to the corresponding temperature structure: the highest concentrations of the diatom-sized fraction regularly showed drastic increase in the colder water mass (especially in the eastern box) with the peak regularly appearing near the cold edge of the front. The size fraction of the small flagellates showed the opposite tendency with the numbers drastically increasing in the warmer side of the front. The size groups with the highest coherence with the chlorophyll fluorescence varied considerably in different water masses. That indicates changes in the size fraction making up most of the chlorophyll standing stock.

The good spatial resolution should allow to extrapolate the spatial patterns of the measurements made by other groups on stations. Beside the transects on the 2 study areas, the underway measurements were also made between the 2 boxes, in the SEABEAM box and on the way to and from the study areas. This will give a larger spatial perspective to the data that was collected only on the 2 mesoscale areas, e. g. to estimate the large-scale biological distributions in relation to fronts and different water masses as well as provide sea-truth distributions for the satellite and/or aircraft measurements.

7.) The distribution of anorganic nutrients

Participants: G. Kattner (AWI)
I. Büns (IBLC)
M. Schütt (IBLC)

During ARK IV/1 nutrients were determined to characterize the frontal zones and to provide chemical data for biological and physical processes. Because the phytoplankton is dependent on nutrients, the data can give a first impression about the phytoplankton growth. Furthermore nutrients are an important tracer for the characterization of water masses besides temperature and salinity.

At about 100 CTD-stations water samples were analyzed to determine the anorganic nutrients nitrate, nitrite, ammonium, silicate and phosphate. Samples were taken from the rosette-sampler at standard depth down to 500 m. At 9 stations deep water samples were analyzed nearly down to the bottom. In the East box nutrients were determined on 5 transects. On the way to the West box at several stations in the Greenland Sea nutrients were measured at CTD-stations. In the West-Box on 7 transects analyzes were performed at all stations in order to get a good coverage with physical and chemical data. In total ca. 1200 samples were analyzed. The nutrients were determined with a continuous-flow-system, the Auto-Analyzer II (of Technicon) with data processing unit.

The frontal zones were clearly detectable by the distribution of the nutrients. This was due to the different concentrations and the different biological activity in the water masses. The gradients in nutrients were large, showing that nutrients are an important oceanographic tracer not only in deep water, but also in the upper layers and frontal zones. Interesting was that in the different frontal areas different nutrients showed the strongest gradients. Thus, in the East box, the Arctic frontal zone, silicate was rather low in the Greenland Sea Gyre, increasing from below 1 μmol to more than 6 μmol in the Atlantic water, whereas the other nutrients were also reduced in the Greenland Sea Gyre but the differences were less pronounced. In the West-box the Polar frontal zone, beside silicate also nitrate showed gradients which were sometimes even stronger than those of silicate. The concentrations were highest in the Polar water and lowest levels were found in the narrow frontal zone, increasing again to the East. The front was best determined on the transect from station 163 to station 173, because of a very close station grid. In this box ammonium showed slightly increased values in the euphotic zone ($> 1\mu\text{mol}$). Nitrite was low at all stations.

8.) Vertical Distribution of Phytoplankton Biomass Copepod Grazing, and Secondary Production

Participants: H.-J. Hirche (AWI)
K. Knickmeier (AWI)
S. Nehring (AWI)
R. N. Bohrer (SFSU)

In our program we concentrated on the description of the vertical distribution of phytoplankton biomass and the measurement of various parameters of copepod feeding and production in relation to the frontal processes along the Arctic and East Greenland Polar Fronts.

Phytoplankton biomass

Vertical profiles of chlorophyll fluorescence were measured at 113 stations with a fluorescence probe attached to a CTD and rosette sampler. These profiles show a clear relation between phytoplankton distribution and water properties. Fluorescence data will be calibrated with the HPLC measurements of Chlorophyll a by C. Trees.

Zooplankton Studies

From 74 vertical tows with a bongo net (300, 500 μm mesh) from 0-100 m samples from one net were preserved in formalin after 1/2 h fixation in glutaraldehyd. These samples will be analyzed for the biomass of various components of the zooplankton and the distribution of species.

From the other net live animals were sorted for measurements of gut fluorescence, egg production and experiments dealing with the lipid metabolism of copepods.

Gut Fluorescence and HPLC Analysis

Together with measurements of the gut evacuation time the gut fluorescence of copepods will be used to determine the grazing rate of the copepods *Calanus finmarchicus* and *C. hyperboreus*.

HPLC analysis of the gut contents (*C. Trees*) will allow to study the phytoplankton taxa the copepods were feeding on. Comparison with pigment analysis from these stations will show whether the copepods were feeding selectively on certain phytoplankton taxa.

Egg Production

Egg production is a good measure for copepod net growth in species with a direct coupling of spawning and feeding such as *C.finmarchicus*. Therefore at 74 stations egg production experiments were set up with this species. With the other important species in the study area, *Calanus hyperboreus* (16 expts) and *Metridia longa* (2 expts) egg production experiments were preformed to study the reproductive state of these populations.

Lipid Metabolism

With *C.hyperboreus* experiments were set up to study the effect of starvation and feeding on the fatty acid and wax ester composition. These experiments are planned for 6 weeks and will be continued during ARK IV-2.

9.) Plankton Communities (Institut für Meereskunde, Kiel)

Participants: J. Lenz
K.-G. Barthel
R. Gradinger
J. Gunkel
F. Kurbjeweit

In our joint study of the Arctic and Polar Fronts we are trying to characterize plankton communities in terms of differences in species composition, seasonal development state, size structure and biomass relationships between autotrophs and heterotrophs within the different water masses forming the fronts. We adjusted our sampling programme to the varying depth of the euphotic zone with the 1% surface light level as its lower boundary. The study on the depth distribution of mesozooplankton ($> 200 \mu\text{m}$) sampled with the multinet by Hydro-Bios was extended to a standard depth of 100 m.

Grazing experiments with heterotrophic nanoflagellates feeding on bacteria and with copepods feeding on different phytoplankton algae, will help to evaluate dynamics of food chain relationships.

A main objective are rate measurements, especially of respiration and excretion of plankton organisms, for assessing metabolic processes as related to species composition and environmental conditions. A comparison between primary production on one hand and overall consumption of organic matter on the other, will indicate the energy balance of the pelagic ecosystem, whether production or consumption predominates or whether both processes are in a state of equilibrium.

Abundance and Grazing Rates of Heterotrophic Nanoflagellates (R. Gradinger)

Recent studies have shown the importance of heterotrophic nanoflagellates in tropical and subtropical ecosystems, but almost no data have so far been published as to their importance in the food web of cold seas.

The first aim of the investigation was to quantify the abundance of bacteria (as main food source for heterotrophic nanoflagellates) as well as that of heterotrophic and autotrophic pico- and nanoflagellates and cyanobacteria (pico- and nanoplankton = ultraplankton). A few ml of seawater from 50%, 15% and 1% light depth were stained with DAPI and filtered on 0,2 μm Nuclepore filters. Using epifluorescence microscopy, autotrophic cells can easily be recognized by autofluorescence of chlorophyll a. Bacteria and heterotrophic nanoflagellates were counted by UV-excitation resulting in a blue fluorescence of the DNA/DAPI complex.

First results indicate that abundance of bacteria and heterotrophic nanoflagellates are closely related to phytoplankton development. High concentrations ($>1.5 \times 10^6$ bacteria/ml; > 2000 heterotrophic nanoflagellates/ml) were observed in the Arctic Intermediate Water of the Greenland Sea Gyre together with a diatom bloom. Very low values ($< 0.2 \times 10^6$ bacteria/ml; < 200 heterotrophic nanoflagellates/ml) were found under the ice within the East Greenland Current, where the low phytoplankton biomass was mainly formed by autotrophic pico- and nanoplankton.

The grazing pressure of heterotrophic nanoflagellates on bacteria was studied with the selective inhibitor technique. Ingestion rates ranged from 10 to 150 bacteria/flagellate/hour and generation times of bacteria from 16 hours to several days.

Phytoplankton and Particulate Matter (J. Gunkel and F. Kurbjeweit)

At 26 stations, the so-called "full" stations of the transects, phytoplankton standing stock was measured as chlorophyll a content by means of a filter fluorometer. Additional samples were taken for the analysis of particulate C and N and for phytoplankton species composition by the Utermöhl technique. Both the latter analyses will be carried out after the cruise in the laboratory.

As a first result, chlorophyll a values for the East Box are available. Within the euphotic zone they range from 0.41 to 2.22 $\mu\text{g/l}$. Usually there is not much variation between the 6 light depths sampled (100, 50, 30, 15, 5, 1%) except at some stations with higher surface values or a deep chlorophyll maximum. The latter were found in the cold Arctic water, suggesting that water masses with a higher plankton content were overlaid.

Depth Distribution of Mesozooplankton (J. Lenz)

A closer coverage of the depth distribution of mesozooplankton ($>200 \mu\text{m}$), which comprises the bulk of major herbivores in the area - these are the 3 *Calanus* species *C. finmarchicus*, *C. hyperboreus* and *C. glacialis* -, aims at a better understanding of the en-

ergy transfer from autotrophic phytoplankton to heterotrophic zooplankton within the pelagic food web.

Samples were taken from (100 - 60 - 45 - 30 - 15 - 0 m) at 25 "full" stations. After splitting them in a Folsom plankton splitter, subsamples were filtered for dry weight estimation with subsequent combustion on Whatman GF/C filters and others preserved for species analysis. An additional subsample was used for live microscopy of the organisms in connection with a video system. This method enables a quick survey of the major species composition and preserves the original colour and shape of the delicate organisms for subsequent examination on the video tape.

A tentative visual examination of the samples revealed marked differences in absolute quantities of zooplankton between the stations. The poorest sample was obtained in the ice-covered Polar water. Maxima were frequently encountered in frontal zones. The copepods, especially the large *C. hyperboreus*, tended to concentrate in the upper two depth layers sampled, in 15 - 30 m and/or in 0 - 15 m.

Metabolic Activity of Zooplankton (K.-G. Barthel)

Zooplankton respiration and nutrient excretion were measured as an index for its metabolic activity within the euphotic zone. 20 l water samples were taken from each of the 6 light depths mentioned above by means of a large rosette for the nano- and microplankton size fraction (<20 µm and 20 - 200 µm). The samples from all 6 depths were mixed and gently concentrated and separated into the 2 size fractions by special concentration devices. The larger zooplankton sampled by a vertical Bongo net haul through the euphotic zone was also split into 2 size classes (200 - 2000 µm, > 2000 µm) by means of gauze filters. The samples were then incubated in rotating glass bottles and kept in the dark at approximately in-situ temperature for 12 hours (the 2 larger size fractions) and for 24 hours (the smaller ones). At the start and at the end of each experiment, oxygen content, ammonia and phosphate were measured in control and experimental bottles. In total, 16 experiments were performed with 480 measurements of each parameter. Additional samples for dry weight and chlorophyll a content as well as for species composition were collected for later analysis in the laboratory.

Experiments to investigate food preferences of copepods were started. Both types of experiments will be continued during the second cruise leg.

Special Studies

The colony-forming haptophycean alga *Phaeocystis pouchetii* is a predominant species of the arctic phytoplankton. It occurs frequently in frontal zones and is very much disliked by planktologists as its mucus clogs nets and filters. Relatively little is known about its population dynamics. At stations with a *Phaeocystis* bloom, the varying size and shape of the colonies were examined in order to document development state and age of the populations in relation to environmental factors. (J. Gunkel)

Another study dealt with the sensory organs of Arctic copepods. A large number of specimens of 5 predominant species in the area (*Calanus finmarchicus*, *C. hyperboreus*, *C. glacialis*, *Metridia longa* and *Euchaeta* spec.) were picked out from Bongo net samples and embedded in special reagents for subsequent electron microscopy. (F. Kurbjeweit)

Station list ARK IV-1 (Plankton Group Lenz)

- Bacteria = Cell counts of bacteria, auto- and heterotrophic
Ultrapl. = ultraplankton in 3 light depths (50, 15, 1%)
- Phytopl. = Chlorophyll a, particulate C + N, Utermöhl sample for species
analysis in 6 light depths (100, 50,30, 15, 5, 1%) + 50 and 75 m
from S. 89 onwards
- Zoopl. = Multinet samples (200 μm) from 5 depth intervals (100 - 60 -
45- 30 - 15 - 0) for biomass estimation (dry weight and organic
matter) and species composition
- Grazing = Grazing of heterotrophic nanoflagellates on
Nanoflag. = bacteria in samples from 50 % light depth
- Respiration = Community respiration and excretion in 4 size + Excretion classes
(< 20 μm , 20 - 200 μm , 200 - 2000 μm , > 2000 μm) integrated
for the euphotic zone.

St. No.	Bacteria Ultrapl.	Phytopl.	Zoopl.	Experimental Grazing Nanoflag.	Work Respiration + Excretion
---------	----------------------	----------	--------	--------------------------------------	------------------------------------

01		x	x	x	x
28		x	x	x	x
30		x	x		
34		x	x	x	x
61	x	x	x	x	x
66	x	x	x		
72	x	x	x	x	x
87	x	x	x		x
89		x	x		
91	x				
94	x	x	x	x	x
101	x	x	x	x	x
102	x	x	x	x	x
104	x				
105	x	x	x	x	
109	x				
110	x	x	x	x	x
117		x	x		
132	x	x	x	x	x
135	x				
136	x	x	x	x	
138	x				
143		x			x
149	x	x	x	x	x
151	x				
153	x	x	x	x	
157	x	x	x	x	x
163	x	x	x	x	x
168	x	x	x	x	
173	x	x	x	x	x
174	x	x	x	x	
179	x	x	x	x	

10.) Biological Oceanography (Phytoplankton)

Participants: Marcus E. M. Baumann (RWTH Aachen)
Joachim Blatt
Maria Krämer
Ursula Stute
Urban Tillman

It is common that frontal regions are characterized by enhanced phytoplankton biomass and production possibly due to the nutrient input into the euphotic zone by upwelling, lateral advection and eddies.

The aim of this cruise was an interdisciplinary study of several groups on the biological properties of the two permanent fronts where water masses of the Greenland gyre touch on one hand the Atlantic water masses (Arctic Front) in the eastern part of the Greenland Sea and on the other hand the Polar water masses (Polar Front) in the western part. In this program the main goals of our group were:

- the estimation of the primary production
- the qualitative and quantitative analyses of the various
- phytoplankton populations,

and at some representative stations the following analyses were performed:

- determination of the ^{14}C - patterns in the photosynthetic end products lipids, carbohydrates and protein
- chemical analyses of lipid-, carbohydrate- and protein contents of various phytoplankton populations.

The primary production was estimated on the basis of its ^{14}C -assimilation at 56 stations from 6 light depths (100%, 50%, 30%, 15%, 5% and 1%) on untreated samples and samples that had been passed through a 20 μm -net to get an idea about the contribution of the phytoplankton less than 20 μm to the total photosynthesis. The figures (10.1 and 10.2) show the results of these production measurements: fig. 10.1 the eastern box on the Arctic Front, fig. 10.2 the western box on the Polar Front. The open bars indicate the total amount of primary production integrated over the euphotic zone, the solid ones the production on the phytoplankton smaller than 20 μm . Production on the Polar Front was obviously higher (fig. 10.2) than on the Arctic Front (fig. 10.1).

This is in accordance with the microscopical analyses of the net plankton hauls we did immediately at every station. Phytoplankton on the Arctic Front consisted of larger diatoms as Thalassiosira species, large Chaetoceros sp., Coscinodiscus sp., Asteromphalus and Thalassiotrix. Apart from that there was a huge amount of Coccolithophorides, Protoperidinees and Ceratium arcticum at some stations. On the Polar Front pennate diatoms mainly occurred with Fragillaria- and Nitzschia- species. The amount of Coscinodiscus significantly reduced; whereas, Eucampia Grenlandia occurred for the first time with fairly high biomass. Opposite to the Arctic Front, the Polar Front had smaller sized Chaetoceros-species such as C. socialis and C. wighamii. The Haptophyceae Phaeocystis pouchetii appeared for the first time and formed blooms at some stations of the Polar Front. All in all it can be said that we have indications that phytoplankton biomass was higher on the Polar Front, but this is preliminary and the Utermöhl countings must be done before results about species distribution can be determined.

Carbon partitioning and chemical analyses were carried out at 10 stations and will be available soon.

Fig. 10.1

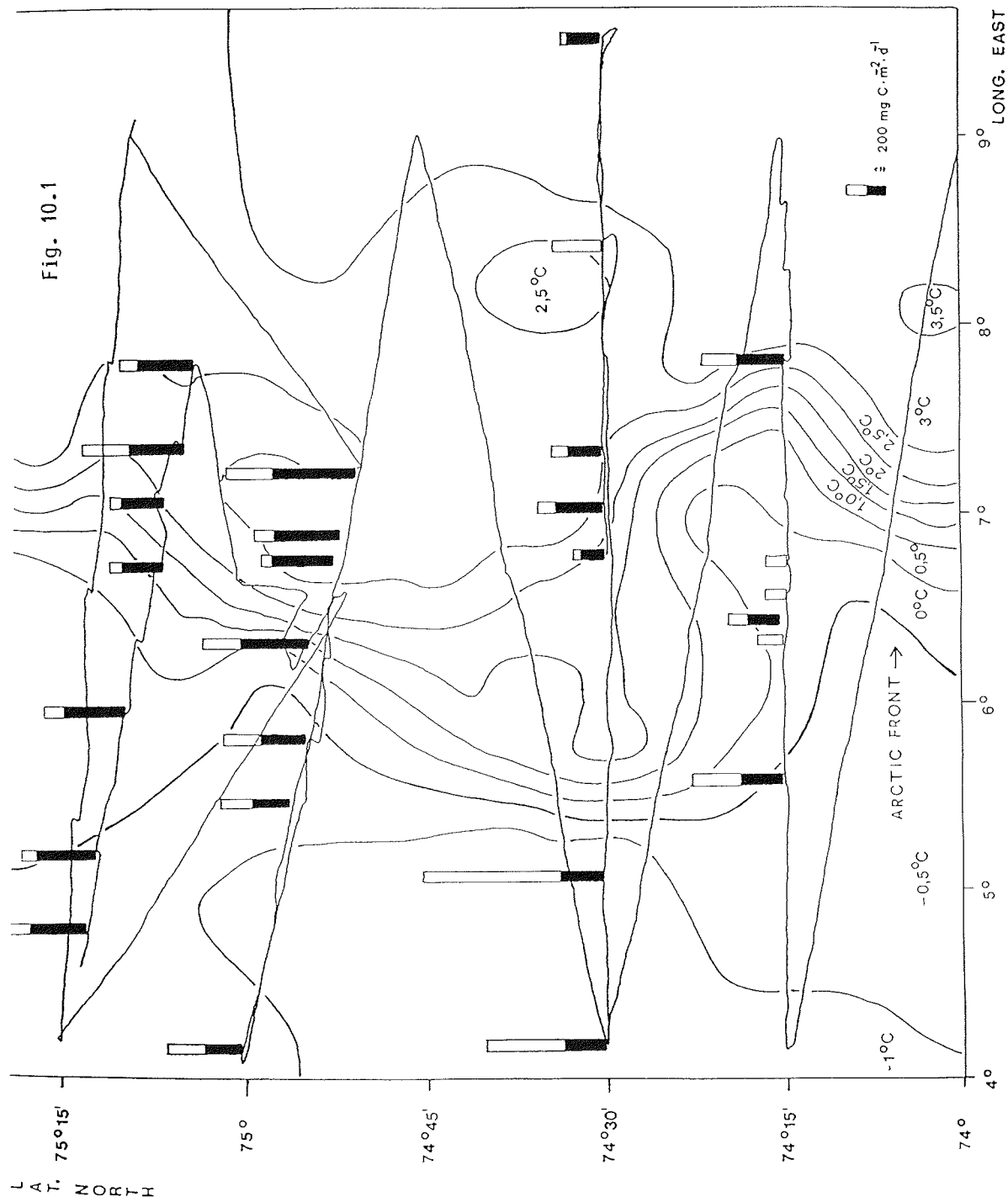
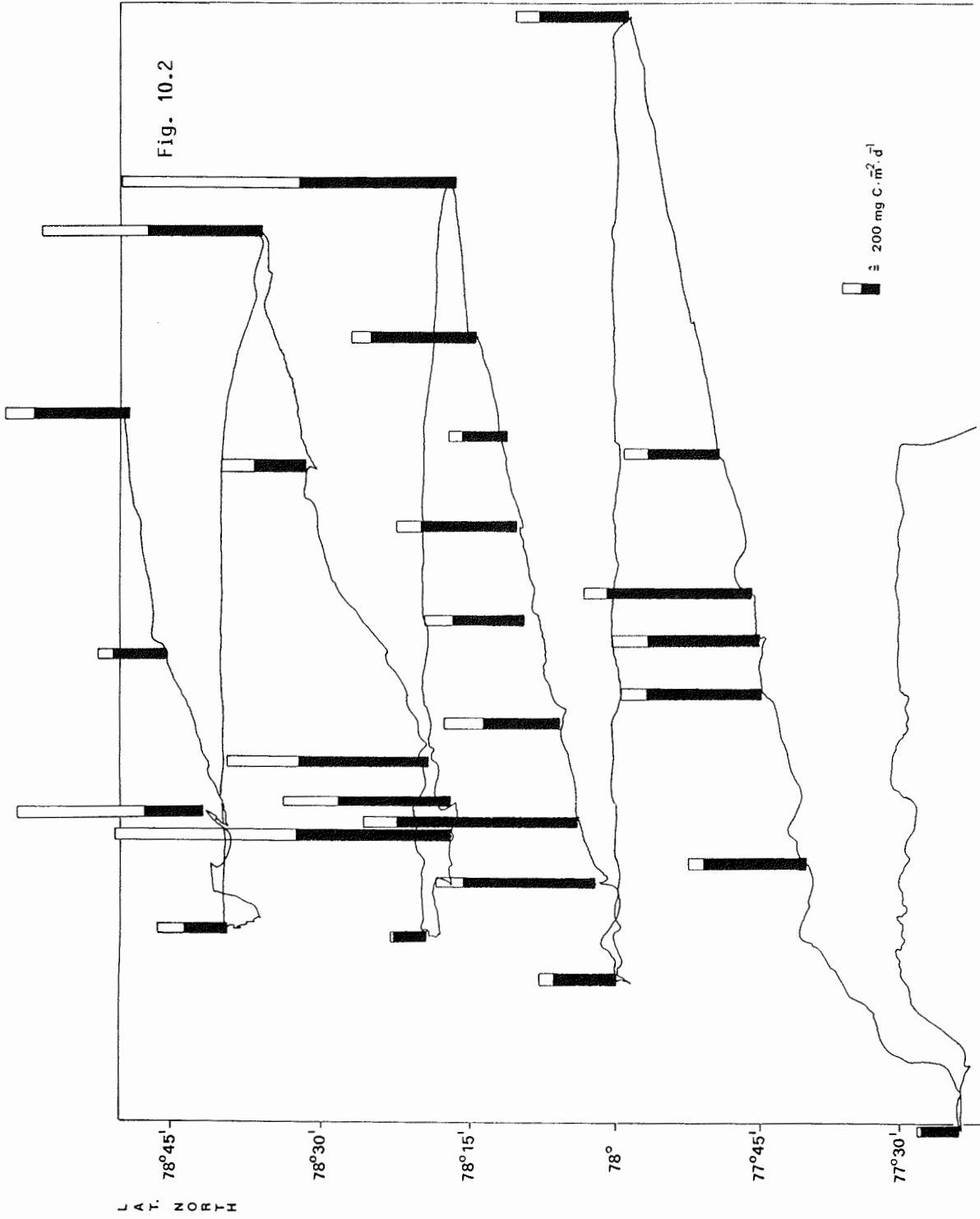

Fig. 10.2



Legends:

Fig. 10.1: Primary production on the Arctic Front. Open bars: total amount of production, solid bars: production of the phytoplankton smaller than 20 μm . The isolines base on the surface temperature measurements from KAHRU et al.

Fig. 10.2: Primary production on the Polar Front. Open bars: total amount of production, solid bars: production of the phytoplankton smaller than 20 μm .

11.) Microbiology

Institute of Ecology at the University of Georgia, Athens, U.S.A

Participant: Donald J. Douglas

Introduction

As the primary producers of dissolved organic carbon in the open ocean, phytoplanktonic algae represent the major source of organic nutrients to heterotrophic bacterial growth. Frontal regions are commonly characterized by enhanced phytoplankton biomass and production. This makes a frontal zone an ideal location to study relationships between bacteria and phytoplankton. One of my main goals on this cruise is to determine whether bacteria populations, at the near-freezing temperatures common in the Greenland Sea during the spring phytoplankton bloom, respond to organic nutrients associated with the phytoplankton by increased growth and activity rates. The methods which I have used to assess bacterial activity and growth were incorporation rates of the DNA-precursor, tritiated thymidine (for estimation of growth and production) and uptake of a mixture of tritiated amino acids (for assessment of relative heterotrophic activity). As well, measurements of cell concentrations of bacteria will be made on samples preserved at sea using epifluorescence microscopy.

Results

Discussion of results at this time obviously must be limited to preliminary observations. However, it is worth noting that there was a very wide range of bacterial production and activity observed over the transects covered on ARK IV/1. In many instances, there was a clear relationship with very low bacterial rates occurring at locations with low phytoplankton biomass e.g. in the Polar water, West Box (Fig. 11.1). At stations with high phytoplankton standing stock, e. g. where we observed a *Phaeocystis* bloom, measurements indicated very high rates of bacterial activity and production (Fig. 11.1). At stations where vertical profiles were analysed through and immediately below the euphotic zone, there was clear evidence of enhanced bacterial rates in the upper water column, where phytoplankton were present and photosynthetically active, as compared to samples collected at greater depths (Fig. 11.1).

A second part of my work involved using a temperature gradient incubator to test the response of bacterial production rates to temperatures from the freezing point of seawater (ca. -1.8 oC) to 10 oC. Preliminary inspection of these data reveal a linear relationship with decreasing temperature to the freezing point (Fig.11.2). This agrees with other measurements I have made recently in cold ocean environments and suggests that bacterial population in cold water environments may not be strongly inhibited at the very low temperatures which are common at the time of the spring phytoplankton bloom at high latitudes.

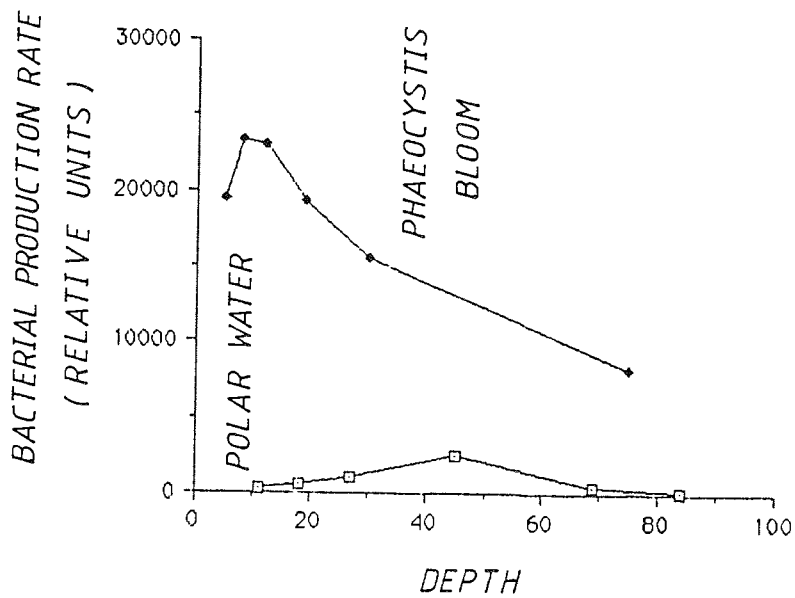

Fig. 11.1 Bacterial production in polar water and in the phaeocystis bloom.

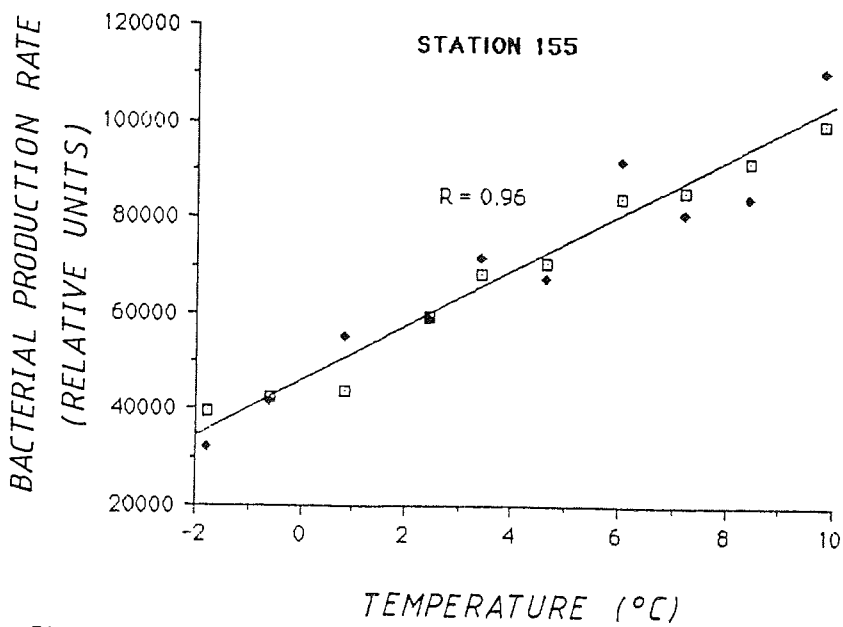

Fig. 11.2 Results of the temperature gradient experiment.

I look forward to collaborating with scientists from the laboratories at Bremerhaven, Aachen and Kiel to compare patterns of bacterial production with their measurements of phytoplankton species, biomass, and photosynthetic production rates.

I thank the Alfred-Wegener-Institut, and particularly Dr. H.-J. Hirche and Prof. Krause for the high level of support and assistance which I received before and during this cruise.

12.) Atmospheric Ozone Profiles

Participants: Dr. K. W. Rothe, Universität München
W. Steinbrecht, Universität München

A newly developed LIDAR-system was installed in a container and is measuring the stratospheric ozone distribution from the upper ships deck. The main feature of this brand-new and unique set-up is its capability of performing ozone measurements even under bright daylight conditions. This can only be achieved by a very narrow-banded and yet sensitive detection system which in turn requires an ultrastable narrowbanded laser system. This is by no means simple - especially under extreme environmental conditions and on board a ship, which is always moving and vibrating. So this first cruise was intended to be primarily a test phase of the apparatus rather than a routine measurement phase. But it was both!! The whole system worked very reliable, and the multitude of stabilizing and controlling elements turned out to be just the right answer to the rough environmental conditions.

So no opportunity for performing measurements was missed - which was very essential, as there were not too many periods with a blue sky in the zenith. Nevertheless the ozone variation with latitude could clearly be observed. In addition a 23 hours continuous measurement phase demonstrated the reliability of the system. So this brand-new and unique apparatus seems to fulfil the very high expectations and has shown itself to be an ideal tool for mapping the ozone distribution and its possible depletion also in the polar regions.

13.) Bathymetric surveys

Participants: F. Niederjasper (AWI)
J. Focke (AWI)

Continuous depth measurements were performed throughout the expedition in parallel to all other research activities. Towards the end of the cruise a special survey of a large area in the east of the Molloy Fracture Zone was conducted as a part of the longstanding program to compile an atlas of the bathymetry of Fram Strait.

Measurements

Depth measurements were carried out with the

- NBS (narrow beam echo sounder) and
- SEABEAM (the multibeam bathymetric swath survey system).

Positions were derived from

- INDAS (Integrated navigation and Data Acquisition System) and
- GPS (Global Positioning System).

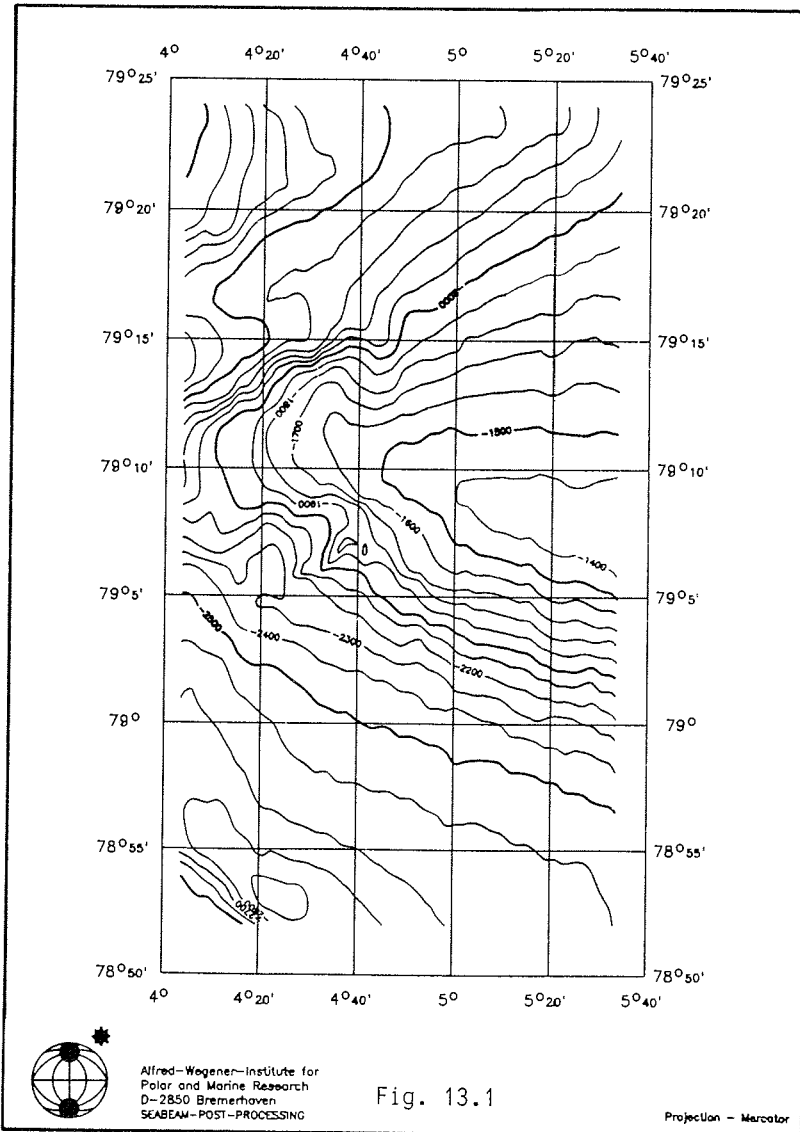

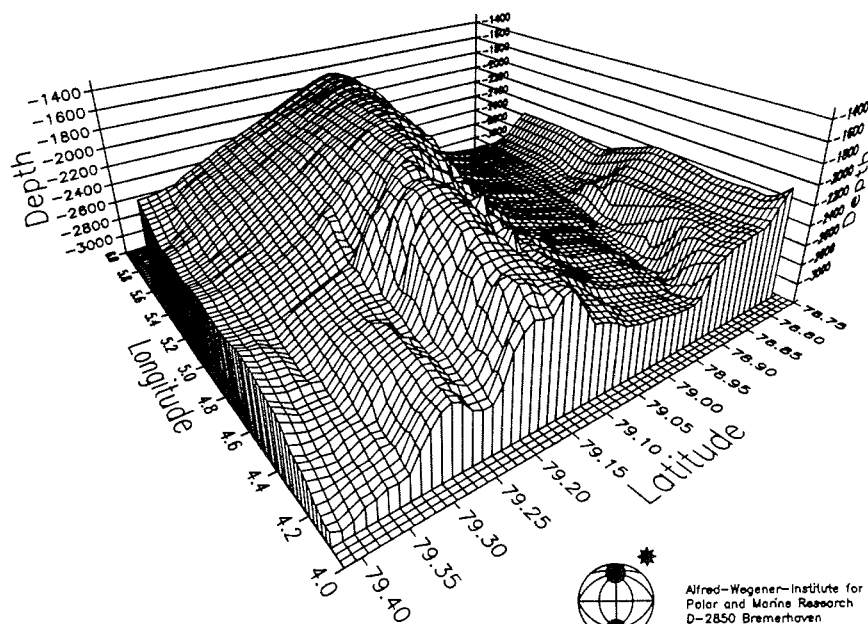

Fig. 13.2

The main activities of bathymetric measurements were done in the Fram Strait adjacent to the SEABEAM surveys of the expeditions ARK II/4 and ARK III/2 & 3. The surveyed area lies east of the Molloy Fracture Zone on the continental slope of Spitsbergen. SEABEAM worked 77 hours in this area and surveyed 2,700 qkm. (Fig.1, 13.1, 13.2). Other areas of interest between 70°24' - 80° N and 0° - 3° E were covered by drifting sea ice, and it was impossible to work there with SEABEAM.

Processing and preliminary results

INDAS and GPS positions and SEABEAM depths were registered online on the board computer VAX 11/750. Positions and depths were merged and stored in files for post processing.

The processing showed inaccuracies in the positions in the south (Fig. 3) because of the integration of the navigation system LORAN C into INDAS which works with TRANSIT satellite fixes and the navigation sensors for speed and heading. During the integration of LORAN C INDAS was updated very often resulting in discrepancies in position determination. These positions cannot be used for the post processing.

Some defects at the projector and hydrophone array under the ship's keel deteriorated the measurements too. Systematic errors bended the contour lines in the chart and reduced the width of the measured swath.

Nevertheless, the preliminary results show that most of the data can be used for the chart production after additional controls and corrections.

Working charts were produced on board for the Fram Strait survey and the East Box.

Notation of the Sections in the East and West Box

Section	Date	Station No.	Time	Latitude	Longitude
1 Box E	19.05.	11/002	02.04	73.59,8 N	009.00,0 E
		11/027	09.25	74.14,0 N	004.18,7 E
2	20.05.	11/028	12.08	74.15,2 N	005.35,4 E
		11/045	08.30	74.15,4 N	008.56,2 E
3		11/046	08.58	74.16,2 N	008.42,2 E
		11/060	18.45	74.30,0 N	004.09,0 E
4	21.05.	11/061	03.11	74.30,0 N	009.30,4 E
		11/072	22.05	74.30,0 N	004.10,0 E
5	22.05.	11/073	14.15	74.45,8 N	008.56,0 E
		11/087	23.24	75.00,1 N	004.05,5 E
6	23.05.	11/088	01.08	74.57,6 N	005.01,3 E
		11/094	17.50	74.49,6 N	007.14,2 E
7	23.05.	11/095	21.25	75.08,8 N	009.00,7 E
	24.05.	11/099	13.21	75.15,3 N	004.11,9 E
8	26.05.	11/102	01.58	75.03,6 N	007.47,0 E
	27.05.	11/117	18.17	75.35,0 N	002.02,0 W
9 Box W	28.05.	11/118	08.26	77.29,8 N	000.00,9 W
	29.05.	11/130	01.20	77.23,9 N	004.59,2 W
10	30.05.	11/131	03.38	77.23,3 N	005.28,2 W
		11/143	12.53	77.57,9 N	000.33,9 E
11	31.05.	11/144	17.38	77.59,9 N	000.00,1 E
		11/149	06.50	77.58,6 N	004.29,8 W
12	01.06.	11/150	09.00	78.01,9 N	003.40,3 W
		11/157	06.59	78.17,6 N	002.07,3 W
13	02.06.	11/158	09.43	78.20,0 N	000.00,4 W
		11/163	00.14	78.18,0 N	004.07,8 W
14	03.06.	11/164	01.10	78.17,6 N	003.39,2 W
		11/173	00.42	78.35,9 N	001.39,4 E
15	04.06.	11/174	08.15	78.39,3 N	004.02,4 W
		11/179	02.35	78.49,4 N	000.18,8 W

STATION LIST

Abbreviations

XBT: Expendable bathythermograph (deep blue version, 900 m)
BRO: "Bio-Rosette", rosette water sampler 6 x 30 l
RO: Neil Brown CTD + rosette water sampler 12 x 12 l
F: at stations indicated by "F" only chlorophyll-
fluorescence was measured and the CTD was not used
OS: Optic sonde
MU: Multi-net
BO: Bongo net
PLA: Phytoplankton-net
BS: Rosette water sampler 24 x 6 l
SBO: "Schließ-Bongo"

Station No	Date 1987	Time	Latitude N	Longitude E	Depth (m)	XBT	BRO	RO	OS	MU	BO	PIA	BS	SBO
015	19.05.	05.29	74.06'	06.51'	2867	X								
015a	19.05.	05.46	74.07'	06.41'	2975	X								
015b	19.05.	06.00	74.07'	06.31'	2860	X								
016	19.05.	06.13	74.08'	06.24'	3113	X								
017	19.05.	06.25	74.08'	06.14'	3253	X								
018	19.05.	06.38	74.09'	06.07'	3305	X								
019	19.05.	06.54	74.09'	05.57'	3302	X								
020	19.05.	07.04	74.10'	05.49'	3010	X								
021	19.05.	07.20	74.10'	05.41'	2906	X								
022	19.05.	07.35	74.11'	05.32'	2850	X								
023	19.05.	07.51	74.11'	05.21'	2780	X								
024	19.05.	08.10	74.12'	05.07'	4570	X								
025	19.05.	08.30	74.12'	04.54'	4390	X								
026	19.05.	08.57	74.13'	04.37'	3505	X								
027	19.05.	09.25	74.14'	04.19'	3970	X								

Station No	Date 1987	Time	Latitude N	Longitude E	Depth (m)	XBT	BRO	RO	OS	MU	BO	PLA	BS	SBO
028	19.05.	12.08	74.15'	05.35'	2800		x	F	x	x	x	x	x	x
		14.15	74.15'	05.35'	2859									
029	19.05.	15.54	74.15'	06.20'	3579	x		F		x	x	x		
		16.40	74.15'	06.19'	3579									
030	19.05.	18.03	74.16'	06.25'	3394	x	x	x	x	x	x			
		20.39	74.15'	06.23'	3568									
031	19.05.	21.25	74.15'	06.34'	3921			x	x		x	x	x	
		22.44	74.15'	06.34'	3047									
032	19.05.	23.19	74.15'	06.45'	3304	x		F			x	x	x	
		20.05. 00.15	74.15'	06.44'	3270									
033	20.05.	01.07	74.15'	07.05'	2319			F			x		x	
		02.04	74.15'	07.04'	2418									
034	20.05.	03.33	74.15'	07.48'	1393		x	F		x	x	x	x	x
		05.27	74.14'	07.48'	1458									
035	20.05.	05.45	74.14'	07.53'	2835	x								
036	20.05.	06.06	74.14'	07.59'	3084	x								
037	20.05.	06.23	74.15'	08.14'	2925	x								
038	20.05.	06.33	74.15'	08.17'	3041			F						
		06.38	74.15'	08.16'	3075			F						

Station No	Date 1987	Time	Latitude N	Longitude E	Depth (m)	XBT	BRO	RO	OS	MU	BO	PLA	BS	SBO
052	20.05.	11.29	74.21'	07.26'	2710	x								
053	20.05.	11.49	74.21'	07.15'	2223	x								
054	20.05.	12.19	74.21'	06.58'	2711	x								
055	20.05.	12.40	74.22'	06.50'	2555				F					
056	20.05.	13.48 13.58	74.23' 74.23'	06.20' 06.20'	2151	x			F					
057	20.05.	14.59	74.25'	05.51'	3394	x			F					
058	20.05.	16.09	74.26'	05.20'	3024	x			F					
059	20.05.	17.14 17.20	74.26' 74.28'	04.50' 04.50'	3375 3375	x			F					
060	20.05.	18.40 18.45	74.30' 74.30'	04.09' 04.09'	2876	x			F					
061	21.05.	03.11 05.34	74.30' 74.29'	09.30' 09.34'	2437 2445	x	x		F x	x	x	x	x	x
062	21.05.	05.54 07.46	74.30' 74.30'	08.52' 08.56'	2634 2624	x			F					
063	21.05.	08.48 10.18	74.30' 74.29'	08.25' 08.29'	2961 3054	x			F x		x	x	x	

Station No	Date 1987	Time	Latitude N	Longitude E	Depth (m)	XBT	BRO	RO	OS	MU	BO	PLA	BS	SBO
075	22.05.	15.10	74.48'	08.18'	3244	X								
076	22.05.	15.51	74.49'	07.51'	2334	X								
077	22.05.	16.18	74.50'	07.33'	2541	X								
078	22.05.	16.53	74.51'	07.10'	2738	X								
079	22.05.	17.20	74.51'	06.52'	2570	X								
080	22.05.	17.48	74.53'	06.34'	2708	X								
081	22.05.	18.19	74.54'	06.16'	2008	X								
082	22.05.	18.41 18.45	74.54'	06.07'	2220	X			F					
			74.54'	06.07'	2619	X								
083	22.05.	19.11	74.56'	05.50'	2643	X								
084	22.05.	19.47	74.56'	05.28'	1963	X								
085	22.05.	20.18	74.57'	05.06'	1917	X								
086	22.05.	20.51	74.58'	04.44'	3392	X								
087	22.05.	21.50 23.24	75.00'	04.10'	3166				F	X	X	X	X	X
			75.00'	04.06'	3145									
088	23.05.	01.08	74.58'	05.01'	3204				F					X

Station No	Date 1987	Time	Latitude N	Longitude E	Depth (m)	XBT BRO RO OS	MU BO PLA BS SBO
110	26.05.	21.45 23.23	75.13' 75.13'	04.48' 04.50'	3011 3250	X F	X X X X X X
111	27.05.	01.04. 02.19'	75.16' 75.16'	04.01' 04.03'	3192 3104	F	X
112	27.05.	04.11 04.21	75.19' 75.19'	03.00' 03.00'	3188 3188	F	
113	27.05.	06.10 07.43	75.22' 75.23'	02.00' 02.01'	2930 2940	F X	X X
114	27.05.	09.30 09.56	75.25' 75.25'	00.58' 00.57'	1777 1821	F	X

Station No	Date 1987	Time	Latitude N	Longitude W	Depth (m)	XBT BRO RO OS	MU BO PLA BS SBO
115	27.05.	11.41 12.21	75.28' 75.28'	00.00' 00.00'	3344 3758	F	X
116	27.05.	14.12	75.32'	01.00'	3750	X F	
117	27.05.	15.58 18.17	75.35' 75.35'	02.00' 02.02'	3726 3725	F X	X X X
118	28.05.	08.26 08.45	77.30' 77.30'	00.01' 00.01'	3173 3173	F	X

Station No	Date 1987	Time	Latitude N	Longitude W	Depth (m)	XBT	BRO	RO	OS	MU	BO	PLA	BS	SBO
132	29.05.	04.26	77.24'	05.44'	447		x	F	x	x	x			x
		06.14	77.23'	05.45'	413									
133	29.05.	10.43	77.40'	03.31'	2898			F	x		x	x	x	
		12.17	77.39'	03.33'	2900									
134	29.05.	12.56	77.41'	03.20'	2950			F	x					
		15.40	77.45'	02.06'	3038									
135	29.05.	15.54	77.45'	02.06'	3038			F	x		x		x	
		17.25	77.45'	02.04'	3036									
136	29.05.	18.27	77.45'	01.40'	3037			F	x	x	x		x	
		20.16	77.45'	01.38'	3038									
137	29.05.	21.15	77.46'	01.17'	3055			F			x	x	x	
		22.20	77.46'	01.16'	3056									
138	29.05.	23.25	77.47'	00.54'	3058			F			x			
	30.05.	00.12	77.46'	00.54'	3098									
139	30.05.	01.25	77.49'	00.07'	3117			F			x	x	x	
		02.38	77.49'	00.08'	3115									
140	30.05.	04.17	77.52'	01.01'E	3133			F			x			
		05.12	77.52'	01.02'E	3130									
141	30.05.	06.49	77.55'	02.04'	3119			F			x			
		07.45	77.55'	02.03'	3118									

Station No	Date 1987	Time	Latitude N	Longitude W	Depth (m)	XBT	BRO	RO	OS	MU	BO	PLA	BS	SBO
142	30.05.	09.11	77.57'	03.00'E	3144									
		10.00	77.57'	03.02'E	3151								X	X
143	30.05.	10.30	77.58'	03.34'E	3161		X		F	X				
		12.53	77.58'	00.34'E	3166							X	X	X
144	30.05.	17.38	78.00'	00.00'	3101					F				
		18.22	78.00'	00.01'E	3100									
145	30.05.	19.50	78.00'	01.00'W	3050					F				
		20.35	78.00'	01.00'W	3049									
146	30.05.	22.05	78.00'	01.59'	2982					F				
		22.44	78.00'	02.00'	2982									
147	31.05.	00.17	78.00'	03.01'	2842					F				
		00.52	78.00'	03.01'	2827									
148	31.05.	02.23	78.00'	04.01'	2574					F				
		02.56	78.00'	04.01'	2567									
149	31.05.	04.45	78.00'	04.27'	2177		X		F	X				
		06.50	77.59'	04.30'	2186							X	X	X
150	31.05.	09.00	78.02'	03.04'	2674					F	X			
		10.30	78.01'	03.39'	2697								X	X
151	31.05.	11.50	78.04'	03.09'	2804					F	X			
		13.33	78.04'	03.09'	2808								X	X

Station No	Date 1987	Time	Latitude N	Longitude W	Depth (m)	XBT BRO RO OS	MU BO PLA BS SBO
152	31.05.	14.47 16.17	78.06' 78.06'	02.21' 02.23'	2937 2933	F X	X X X
153	31.05.	17.56 19.07	78.08' 78.08'	01.28' 01.26'	3010 3010	F	X X X X
154	31.05.	20.18 21.09	78.10' 78.10'	00.42' 00.43'	3074 3070	F	X X X X
155	31.05.	22.30 24.00	78.12' 78.12'	00.06'W 00.01'E	3045 3047	F	X X
156	01.06.	01.20 02.56	78.14' 78.15'	00.54'E 00.52'E	3021 3006	F	X X X
157	01.06.	04.45 06.59	78.17' 78.18'	02.10'E 02.07'E	1936 1924	X F X	X X X
158	01.06.	09.43 10.15	78.20' 78.20'	00.00' 00.01'W	2205 3006	F	
159	01.06.	11.55 13.38	78.20' 78.20'	01.02'W 01.03'W	2911 2974	F X	
160	01.06.	15.00 15.34	78.20' 78.20'	01.59' 01.58'	2944 2944	F	
161	01.06.	18.00 19.20	78.21'	03.05'	2633	Eisgang F	

Station No	Date 1987	Time	Latitude N	Longitude W	Depth (m)	XBT BRO RO OS	MU BO PLA BS SBO
162	01.06.	20.08 20.15	78.20' 78.20'	03.30' 03.30'	2422 2422	F	
163	01.06. 02.06.	22.15 00.14	78.19' 78.18'	04.07' 04.08'	1886	Eisgang x F	x x x x x
164	02.06.	01.10 01.53	78.18' 78.17'	03.39' 03.41'	2375 2372	F	x
165	02.06.	02.24 02.44	78.17'	03.32'	2486	F	
166	02.06.	03.25 04.22	78.17' 78.16'	03.16' 03.17'	2639 2629	F	x x x
167	02.06.	05.37 06.21	78.17' 78.17'	03.01' 03.03'	2756 2749	F	x
168	02.06.	07.40 09.31	78.19' 78.19'	02.41' 02.44'	2828 2817	x F x	x x
169	02.06.	11.02 11.50	78.22' 78.22'	02.08' 02.09'	2909 2910	F	x x
169a	02.06.	12.44 13.37	78.24' 78.23'	01.46' 01.47'	2929 2931	F x	
170	02.06.	14.49 15.37	78.29' 78.29'	01.10' 01.11'	2842 2842	F	x x

Station No	Date 1987	Time	Latitude N	Longitude W	Depth (m)	XBT	BRO	RO	OS	MU	BO	PLA	BS	SBO
171	02.06.	17.10	78.32'	00.12'	2775			F	x		x	x		
		18.23	78.31'	00.13'	2787									
172	02.06.	19.51	78.34'	00.46'E	2303			F			x	x		
		20.32	78.34'	00.45'E	2167									
173	02.06.	22.13	78.37'	01.47'E	2399		x	F		x	x	x	x	x
	03.06.	00.42	78.36'	01.39'E	2394									
174	03.06.	08.15	78.39'	04.02'	1709			F	x	x	x		x	
		12.09	78.36'	03.58'	1809									
175	03.06.	12.59	78.41'	03.46'	1976			F						
		13.05	78.41'	03.46'	1983									
176	03.06.	13.44	78.41'	03.31'	2136			F			x			
		14.26	78.41'	03.33'	2122									
177	03.06.	16.00	78.42'	03.05'	2392	Eis		F	x		x	x	x	
		18.38	78.40'	03.10'	2315									
178	03.06.	20.50	78.46'	01.41'	2729			F			x	x		x
		21.55	78.46'	01.44'	2734									
179	04.06.	00.01	78.49'	00.20'	2672			F		x	x	x	x	x
		02.35	78.49'	00.19'	2668									
180	04.06.	03.14	78.54'	00.00'	2546	Seabeam-Profil								
	05.06.	14.53	78.54'	04.52'E	2678									

CRUISE LEG ARK IV/2

June 9 - July 1, 1987, Longyearbyen - Tromsø

1. General cruise description. (J. Meincke, IFMH, chief scientist)

The cruise leg aimed at interdisciplinary investigations of water masses and frontal structures in Fram Strait and in the Western Greenland Sea between Fram Strait and Jan Mayen (See cruise map, Fig. 1). In contrast to cruise leg one the spatial scales of the observational programme were larger in order to allow for a coverage of the Greenland Sea gyre which is the center of deep overturning of water masses during wintertime. This overturning depends critically on the water mass exchanges between the Arctic Ocean and the European Subarctic Seas, on the transport of these water masses along the perimeters of the Greenland Sea gyre and on their exchanges with the gyre's interior across the frontal boundaries. It is the focus of the international Greenland Sea Project to obtain a seasonal data set of the physics, chemistry and biology of the Greenland Sea gyre in the period summer 88 to summer 89 in order to quantify the overturning and the processes relevant to it. Thus the "Polarstern"-cruise leg 2 was considered a preparatory cruise for this project, allowing to obtain necessary planning information for the least known western Greenland Sea, to test jointly used methods and intercalibration procedures, and to install current meter moorings to be maintained sufficiently long in order to resolve for the dominant time-scales of the Greenland Sea processes..

"Polarstern" left Longyearbyen on June 9, 1987 and spent the first 8 days in the Fram Strait on three major subjects: recovery of 6 moorings along 79° N and redeployment of 2 moorings to continue the multi-year time series over the Svalbard slope and the Greenland slope; working a hydro-biological section along 79° N crossing the Arctic / Polar front; working the Fram Strait section along 80° N, which has been repeated five times since 1983 with closely spaced hydrographic stations between the Greenland Shelf and the Svalbard Shelf. The work was hampered by rather severe ice conditions, which did not allow to recover two shelf-moorings on 79° N.

Fram Strait was left on June 17. The vessel headed southwestward to the Greenland continental slope around 75° N, where a detailed hydro-biological section across the Polar front was carried out. It was followed by in-ice deployment of 4 current meter arrays, before a long hydrographic section crossing the Greenland Sea gyre to Jan Mayen was taken up. After further deployment of 3 moored arrays another detailed hydro-biological section was run across the Polar front over the Greenland continental slope around 72° N. From June 26 onward a second long hydrographic section crossing the Greenland Sea gyre was run. It was finished on June 29. After a mooring deployment at the southeastern tip of the Greenland Sea fracture zone the scientific work was completed. The vessel arrived in Tromsø in the late afternoon of July 1.

2. Report of the scientific groups

2.1 Physical oceanography

Participants:	K. Aagaard (PMEL)	D. Grawunder (IfMH)
	D. Bos (SIO)	J. Meincke (IfMH)
	H. Dahlggaard (RNL)	D. Olbers (AWI)
	C. Darnell (PMEL)	G. Rohardt (AWI)
	W. Emery (CCAR)	B. Rudels (NPI)
	E. Fahrbach (AWI)	J. Segschneider (IfMH)
	T. Field (SIO)	H. Wüllner (IfMH)

The investigations were aimed at quantifying the water mass exchanges between the Arctic Ocean and the European Subarctic Seas and at identifying the role of these exchanges on the deep water renewal in the Greenland Sea. The key region for investigating water mass exchanges is Fram Strait. Transport estimates by means of repeated hydrographic sections, long-term moored current meters and bottom pressure recorders are underway since 1983 and were reworked during this cruise leg. Six moorings were recovered, two of them were redeployed (stations 216, 217). This decrease of current monitoring-activities in Fram Strait is considered temporary to allow for an evaluation of four years of measurements and to enable an optimal design of further monitoring measurements. The hydrographic situation in the Fram Strait section was found rather anomalous. In contrast to preceding years there was no clear salinity maximum from Arctic Ocean Deep Water spreading southward along the Greenland continental slope, instead salinities were generally high (~ 34.92) over most of the deep Fram Strait (Fig. 2). A first interpretation would call for strong mixing having occurred between the deep waters from the Arctic Ocean (salinity ~ 34.93 - 34.94) and deep water from the Greenland Sea (salinity ~ 34.88 - 34.89). Thus Fram Strait proved once again to have its own dynamics rather than being a passive transit channel.

The work in the Greenland Sea was aimed at tracing the water masses of the East Greenland current, the Atlantic return flow and the deep Arctic outflow along the western and the southern perimeter of the Greenland Sea gyre and derive from their changes information on mixing rates. They are essential in terms of pre-conditioning the Greenland Sea interior for deep overturning during the winter period. For these estimates the following parameters were obtained/sampled: temperature, salinity, oxygen, tritium, caesium 137 and technetium.

Although the anthropogenic tracers have not yet been analysed from the samples, the salinity distribution from a total of 5 sections (for example see Fig. 3, station Nos 254-266) clearly shows the advective peripheral spreading of the deep waters from the Arctic Ocean and the Atlantic water from recirculation in Fram Strait. This result is considered a first time quantitative proof of an up to now hypothetical advection pattern.

Four current meter moorings over the East Greenland continental slope (stations 228, 230, 233 & 234) were deployed to obtain scales and character of fluctuations in the gyre frontal zone. Three arrays were deployed in the southern Greenland Sea (stations 240, 241, 242) to monitor the circulation. Two near bottom moored arrays were deployed near both ends of the Greenland fracture zone (stations 218, 267) to detect deep exchanges between the Greenland Sea basin and the northerly adjacent Boreas basin. Current measurements at these positions will most probably be continued within the moored array network of the Greenland Sea Project.

2.2 Sea Ice Morphology and Transport

Participants: B. Erlingsson (NPI)
T. Vinje (NPI)

The investigations are part of a long term programme for the evaluation of ice fluxes under the international programmes: "The Heat Budget of the Arctic Ocean" and "The Greenland Sea Project". The Fram Strait is in this connection a key area.

Five ice bottom topography series, each covering about 8000 m² were obtained with the Mesotech 971 scanning sonar. The sonar head was lowered through a drilling hole in the ice and operated at a depth of 15 m below the sea surface. To get a good three-dimensional picture (Fig. 4), scans were made every five degrees. The topography of the top-surface was measured with the aid of stereophotography, using a Hasselblad special camera for mapping. An example of the corresponding top- and bottom topographies (Fig. 5) indicates that the isostatic equilibrium is poor in the two-dimensional plane. The measurements will e.g. be used to study the statistic features of the three-dimensional ice thickness distribution.

An upward looking sonar (ULS) was attached to the top of a mooring at 75° 04.7' N and 12° 09.2' E. The instrument, which is a prototype, is preset to measure the ice draft every four minutes. The series will be of value in connection with the estimation of the ice volume transport. The instrument is planned to be redeployed at the same position next June with additional ULSs further north in the Fram Strait from September on. In addition the ice fields were characterized at intervals according to the WMO ICEOB code.

2.3 Passive Microwave Remote Sensing of Ice, Seas State and Atmosphere

Participants: K. Asmus (AES) C. Garrity (YU)
M. Cameron (YU) M. Gassel (AES)
L. Creasman (AES)

The activities of this project were a direct continuation of the work carried out during leg one, i.e. three ice reconnaissance flights, eight complete ice stations, and the quasi-continuous microwave imaging of the ice, the water and the atmosphere were added to the material obtained in the period May 15 to June 8. Tables 2 and 3 give summaries of the reconnaissance flights and the ice stations worked during both cruise legs.

2.4 Sea-Ice Coring

Participants: R. Steinmetz (AWI)
G. Weide (AWI)

The aims of the project is a description of species-composition and spatial distribution for organisms living in Arctic sea-ice. For this purpose a total of 37 ice-cores were obtained, parameters like floe thickness, salinity and temperature distribution within the core were measured. The further treatment of the material consisted of counts of total cell numbers and of isolation of living micro-heterotrophic bacteria and fungi as well as of determination of ATP and chlorophyll concentration.

The first results showed maximum numbers of bacteria in the upper and lower layers of the ice-floes. The total numbers of saprophytical bacteria ranged between 2 and 700 x 10⁶ cfm/l. With respect to higher and lower fungi similar conditions as in Antarctic sea ice were found, reassuring fungi to be a permanent component of the sea-ice fauna.

2.5 Ozone Profiling

Participants: S. El-Naggar (AWI)
W. Steinbrecht (AWI)

A recently developed ozone-lidar (light detection and ranging) system was successfully tested during cruise legs 1 and 2. The mobile unit allows ozone-profiling at 200 m increments of the stratosphere during day and night so that the ozone distribution can be obtained as a function of space and time during near cloud-free or cloud-free conditions. Measurements were taken in the area 60° to 80° N, 10° E to 10° W with the following results

- The ozone profiles show a strong variation in time (see Fig. 6 a), possibly caused by weather conditions or strong high level winds.
- The total concentration decreased between 60° N and 80° N from 460 to 340 DU (see Fig. 6 b)
- The height of the ozone maximum increased from 16 km at 60° N to 19 km at 80° N (Fig. 6b)
- No significant longitudinal dependence of the ozone distribution was observed.

In general the observed values are well within the range of natural fluctuations derived from satellite observation. The repeated coverage of the area allowed to detect the decrease of the total ozone concentration with the season progressing towards summer.

2.6 Anorganic nutrients

Participant: G. Kattner (AWI)

During the cruise leg ARK IV/2 nutrients were determined on the biological transects using an AutoAnalyzer II system. The phytoplankton is dependent on the available nutrients which may limit the phytoplankton growth. Ammonium is released by zooplankton and decomposition of organic particulate material. Furthermore nutrients are a tracer for the characterization of water masses. At about 33 stations water samples (12 to 20) were analyzed for nitrate, nitrite, ammonium, silicate and phosphate. Samples were taken with the rosette sampler at light depth and standard depth down to about 500 m. The frontal zone of the Fram Strait transect was characterized by totally depleted nitrate concentrations in the surface down to 5 - 10 m. At these stations the ammonium concentrations increased to more than 2 $\mu\text{mol/l}$ at depths between 50 and 100 m. On the other transects nutrients were not as much depleted in the surface as on the Fram Strait transect. The frontal zones and different water masses were clearly detectable by the different nutrient concentrations and the different ratios between the nutrients. The gradients were sometimes large, with low concentrations closely bounded to the frontal areas due to the high biological activity in these fronts.

In addition some ice cores were analyzed to their nutrient compositions in 10 cm intervals. Within the ice sometimes high ammonium and nitrite concentrations were detected, but in general the nutrients were low.

2.7 Bacteria

Participants: H.-J. Rüger (AWI)
C. Summa (AWI)
L. Tan (AWI)
K. Wohler (AWI)

Water and sediment samples from 4 shelf-stations and 6 stations in the deep basin were taken to study biomass, activity and structure of low-temperature adapted bacteria populations. Different methods to determine bacteria numbers were employed and compared: colonies on agar-agar (membrane filter method), most probable number method (MPN) with two different media for heterotrophic and oligotrophic bacteria, direct counting after dying with acridinorange and ATP-biomass determinations. The first results are presented in table 4.

To estimate the bacterial activity the experiments with bacteria cultures were started during the cruise leg and will be continued in the laboratory with the respiration-electron-transport system (ETS) and the adenylate energy charge values (AEC). 560 low-temperature adapted heterotrophic bacteria were isolated from water and sediment samples for investigations on the population structure. From cultures enriched in dialysis chambers and on membrane filters experiments for isolating oligotrophic bacteria have been taken up.

2.8 Biological oceanography-phytoplankton

Participants: M. Baumann (RWTH)
M. Krämer (RWTH)
U. Stute (RWTH)
U. Tillmann (RWTH)

During the second leg of the ARK IV-expedition investigations on the Polar Front were continued from the first leg. Four transects with a total of 30 stations were obtained. The main goals of the station work consisted of the estimation of the primary production on the basis of its ^{14}C -assimilation in the euphotic zone, on samples from the 100% to the 1% light depth and the preserving of these samples for the qualitative and quantitative analysis of the phytoplankton. Additional measurements concerning the ^{14}C -patterns in photosynthetic end products and proteins and the chemical analyses of the lipid-, carbohydrate-, and protein contents of various phytoplankton populations were done at some representative stations. Table 5 gives an overview about the stations and the investigations undertaken.

Apart from this station work the group isolated some numerically important algae species from the natural phytoplankton communities, cultivated them under simulated environmental conditions and undertook some autecological experiments concerning same parameters as mentioned above. The main algae isolated were several Thalassiosira-sp., some Chaetoceros-sp., Melosira arctica, Thalassiotrix, and Porosira glacialis.

The results of the primary production measurements show high production rates during the second and the fourth transect, during the first and third, production was fairly low. This is due to the phytoplankton distribution. The data result in low densities of presumably pennate diatoms, some Thalassiosira-sp., Eucampia spec., and Chaetoceros socialis, and silicoflagellates on the first transect. The second transect was characterized by a large abundance of Phaeocystis pouchetii and huge amounts of small Chaetoceros-species. A mostly heterotrophic plankton was found at the beginning of the third transect: Gyrodinium-, Nematodinium- and Gymnodinium-species, and only

small numbers of T. nordenskiöldii and Asteromphalus. At the end of the transect, diatoms increased, and hence production rates also rose. During the last transect, the fairly high production on the first four stations was caused by diatoms as Rhizosolenia hebetata, C. convolutus, C. decipiens and some Thalassiosira-species. On the next four stations production decreased, hence phytoplankton density was low. At the last station of the transect, diatoms were fairly abundant with large numbers of Thalassiosira- and Fragillaria-species. Of course, these results are preliminary, and need a revision after the "Utermöhl"-countings have been done.

After the third biological transect, there was an opportunity to do an extra biological station during an oceanographical transect in a bloom of prasinophytes. This was of high interest, because prasinophyte-blooms in that regions have not been observed yet. Apart from that during another oceanographical transect benthic algae which were growing in metres long floating "tails" below the ice flows were collected from the rubber boat. This turned out to be Melosira arctica together with small Navicula-like pennate diatoms.

2.9 Biological oceanography - plankton communities and ecosystem dynamics

Participants: K.-G. Barthel (IfMK)
R. Gradinger (IfMK)
J. Gunkel (IfMK)
N. Keene (UOT)
F. Kurbjeweit (IfMK)

During the second leg the work from leg one was continued. The main objective was to characterize plankton communities in different water masses and to study ecosystem dynamics by investigating metabolic processes of nano-, micro- and meso-plankton. We concentrated on the euphotic zone, i.e. the water column above the 1% light depth, as the area of high plankton biomass and activity. The vertical distribution of zooplankton >200µm was investigated in the upper 100 m.

Autotrophic and heterotrophic nanoplankton.

At 21 stations the vertical and horizontal distribution of bacteria, cyano-bacteria and the autotrophic and heterotrophic nanoplanktons was investigated. Samples from 50%, 15% and 1% light depth were stained with DAPI, concentrated on filters and counted with an epifluorescence microscope. Large differences were found in the central Greenland Sea in relation to the hydrographic situation. In general bacterial biomass varied in a similar fashion as did micro- and mesoplankton biomass. Cyanobacteria were only found in water masses of Atlantic origin. A further evaluation will be especially concerned with the abundance of different size classes in relation to depth.

Grazing of heterotrophic nanoflagellates on bacteria as well as bacterial growth were measured with the selective inhibitor technique. The number of bacteria ingested per flagellate and hour lay with 10-150 in the expected range.

In co-operation with N. Keene (University of Tennessee) the competitive uptake of ammonia by bacteria and phytoplankters was investigated. There are as yet no results available since ¹⁵N measurements were not possible on board. It could be shown that the elevated ammonia concentrations which were due to the addition of marked ammonia did not increase bacterial growth.

Phytoplankton and particulate matter

Samples for chlorophyll a, particulate carbon and nitrogen and phytoplankton species analysis were taken from 6 light depths in the euphotic zone and, when possible, from 50 m and 75 m. While C/N and species analyses are not yet available, the chlorophyll a data show much higher variations of phytoplankton biomass than during the first leg. Maximum values in a bloom on station 215 were $7\mu\text{g}\cdot\text{dm}^{-3}$, while on station 195 concentrations were as low as $0.1\mu\text{g}\cdot\text{dm}^{-3}$. On the Fram Strait section at 80°N a Phaeocystis bloom was present at all stations between 1°W and 10°E . The southernmost section at 71°N was characterized by a Rhizosolenia species and a very small Chaetoceros species.

On selected stations an additional Phaeocystis programme was carried out. Size and shape of the colonies were noted and photographic and video pictures were taken of living colonies in order to document typical colony forms. First results indicate that in a bloom situation Phaeocystis colonies are mainly large with hemispherical protrusions, in total 0.8-1.2 mm long and 0.6-0.9 mm wide. An analysis of the size-frequency distribution of colonies in the water column is currently worked upon.

Zooplankton distribution

Sampling of the mesozooplankton ($>200\mu\text{m}$) as carried out by J. Lenz on the first leg was continued with the Hydro-Bios multinet. 5 depth intervals (100-60-45-30-15-0 m) were sampled and sub-samples taken for dry weight and species analysis. A first visual inspection of the samples revealed large differences in number and species composition between stations. High phytoplankton concentrations seem to be avoided by the zooplankton.

Metabolic activity of zooplankton

Respiration and excretion of zooplankton from the euphotic zone were measured in 4 size classes ($<20\mu\text{m}$, $20-200\mu\text{m}$, $200-2000\mu\text{m}$, $>2000\mu\text{m}$) as an indicator for their metabolic activity. From each of the 6 light depths 20-30 l water samples were taken, combined, gently concentrated and separated into the two smaller size classes. The mesozooplankton ($>2000\mu\text{m}$) was collected with a Bongo net from the euphotic zone and also concentrated and separated into the two larger size classes. Prior to and after the incubation, oxygen, ammonia and phosphate concentrations were measured. Dry weight, chlorophyll a content and species composition will be analyzed later on. First results revealed large differences between stations possibly depending on the origin of the water masses. The contributions of the smaller size classes to nutrient regeneration were sometimes 10 times higher than those of the larger size classes (e.g. on station 219) while at other stations the large animals contributed most (e.g. on station 227). This stresses the importance of microzooplankton for nutrient regeneration in this area.

In co-operation with M. Krämer (RWTH Aachen) grazing experiments to investigate food preferences of copepods were performed. Gut fluorescence data will be evaluated in the laboratory later on.

Sensory organs of copepods

Five different species of copepods (Calanus finmarchicus, Calanus glacialis, Calanus hyperboreus, Metridia longa, Euchaeta sp.) were sorted from Bongo net samples and preserved for investigation of chemo- and mechanoreceptors by means of electron microscopy. Different preservation techniques were used and will be compared during

the investigation since up to now no standard technique for copepods has been established. Live observations of copepods reacting to mechanical stimuli were carried out.

2.10 Biological oceanography - Food chain dynamics

Participants: R. Bohrer (TCES)
H.-J. Hirche (AWI)
L. Thomsen (AWI)
K. Knickmeier (AWI)

The biological-physical program on the relationship between frontal processes and biological production was continued on the second leg on three transects.

Vertical profiles of chlorophyll fluorescence were measured at 33 stations. On the same stations bongo net tows to 80 m were taken for zooplankton biomass and live animals. The latter were used for egg production and gut fluorescence measurements of the dominant herbivorous copepods.

Additional experiments were conducted to study the reproductive biology of Calanus glacialis and Metridia longa in detail.

2.11 Biological oceanography - Particle series in relation to water masses

Participants: M. Kahru (ITE)
S. Nommann (ITE)
J. Sildan (ITE)

The pumping of surface water and the automated measurements of the concentration of 12 size classes of particles (mostly plankton) as well as chlorophyll a *in vivo* fluorescence were continued along the lines followed during cruise leg 1. An amount of 670 nautical miles of continuous profiling were obtained during ARK IV/2, so that data from a total of 2240 n.m. are available for an investigation of the distribution of the above mentioned parameters in relation to near surface water masses.

2.12 Biological oceanography - Macrozooplankton

Participant: R. Haas (FSF)

Continuing work during the prior cruises ARK I, II and III (1983 - 1985) the Bongo net and the Neuston net were used to study the distribution of Arctic zooplankton (euphausiids, amphipodes, ostracodes, copepodes, decapodes, chaetognathes, pteropodes) in Fram Strait and the Greenland Sea.

Experimental work was performed on the feeding behaviour of Themisto libellula and Themisto abyssorum. A first result showed them to be primarily predators even if a sufficient amount of phytoplankton or Calanus hyperboreus (6-7 mm) and euphausiids (9 mm) were offered. Investigations on the growth and development of T. libellula and T. abyssorum could not be carried out as planned, since no females carrying eggs or pantochelis-stadia and no young larvae of these kinds were found in this area. Most likely these stages of development will be found during earlier parts of the year.

2.13 Biological oceanography - Feeding biology of dinophytes

Participant: M. Elbrächter (BAH)

The main aim of the project was to investigate the feeding biology of dinophytes, which are an important stock of unicell algae in this area. In addition, some observation on ice algae were carried out. For the documentation of the experiments a video-system was employed. Phytoplankton was sampled on 63 stations with a 10 µm hand-held net. Part of each sample was used for experiments right after obtaining it, part was fixated for taxonomic determinations. By means of fluorescence-microscopy the chloroplast were used to distinguish between phototrophic and heterotrophic species. All members of the species Ceratium and Gonyaulax were found phototrophic, as well as many from the species Gymnodinium, Gyrodinium and Katodinium. Aberrant fluorescence was observed on the phototrophic members of the species Dinophysis. Instead of deep-red primary fluorescence they showed light-orange fluorescence at a different wave length. This was typical for the pigments and phycobilin. Possibly a symbiosis between a heterotrophic dinoflagellate and a cryptophyt was observed. Two kinds from the family of Warnowiaceae were found to be special. By means of their complicated, eye-like organell they can feed on organisms, but have a working chloroplast as well. Thus they feed mixotrophic.

Some peridinales from the group of heterotrophic dinoflagellates were documented during "pallium-feeding". After digestion the remnants are excreted. These fecal pellets (50x 30 µm) are embraced by a robust involucre and were found frequently in nets and sediment-traps. Thus fecal pellets from dinophytes contribute to the vertical flux of matter in the ocean.

The life-cycle of a parasitic dinophyte (found in copepode-eggs) could be clarified. This so far unknown parasite differs so much from the known species that it is to be described as a new one.

Additional investigations were carried out on ice-algae. Diatoms, dinoflagellates and prasinophytes were found, the latter blooming even in the open water between the ice on one occasion. Several times Actiniscus was observed with a endo-skeleton from silicic acid. Some dinoflagellates were found with elements of a skeleton similar to Discoaster. So far these skeleton elements have been attributed to fossile coccolithophorids.

List of figures:

- Fig. 1 Station map ARK IV/2 .
- Fig. 2 Temperature and salinity distribution on a section across Fram Strait (Station Nos. 196-215).
- Fig. 3 Temperature and salinity distribution on a section across the Greenland Sea gyre (Station Nos, 254-266).
- Fig. 4 The topography of the underside of firstyear ice with some ridging as estimated with the aid of Mesotech 971 scanning sonar. The ice floe is turned upside down. The dimensions of the box is 40 m by 40 m by 10 m.
- Fig. 5 Typical samples of bottom and surface profiles for firstyear ice (left) and multiyear ice. Numbers are dimensions in meters.
- Fig. 6a (left) Short-term variation of an ozone profile.
- Fig. 6b (right) Dependence of the total ozone-concentration on the latitude (x). Height-variation of the ozone-maximum (o).

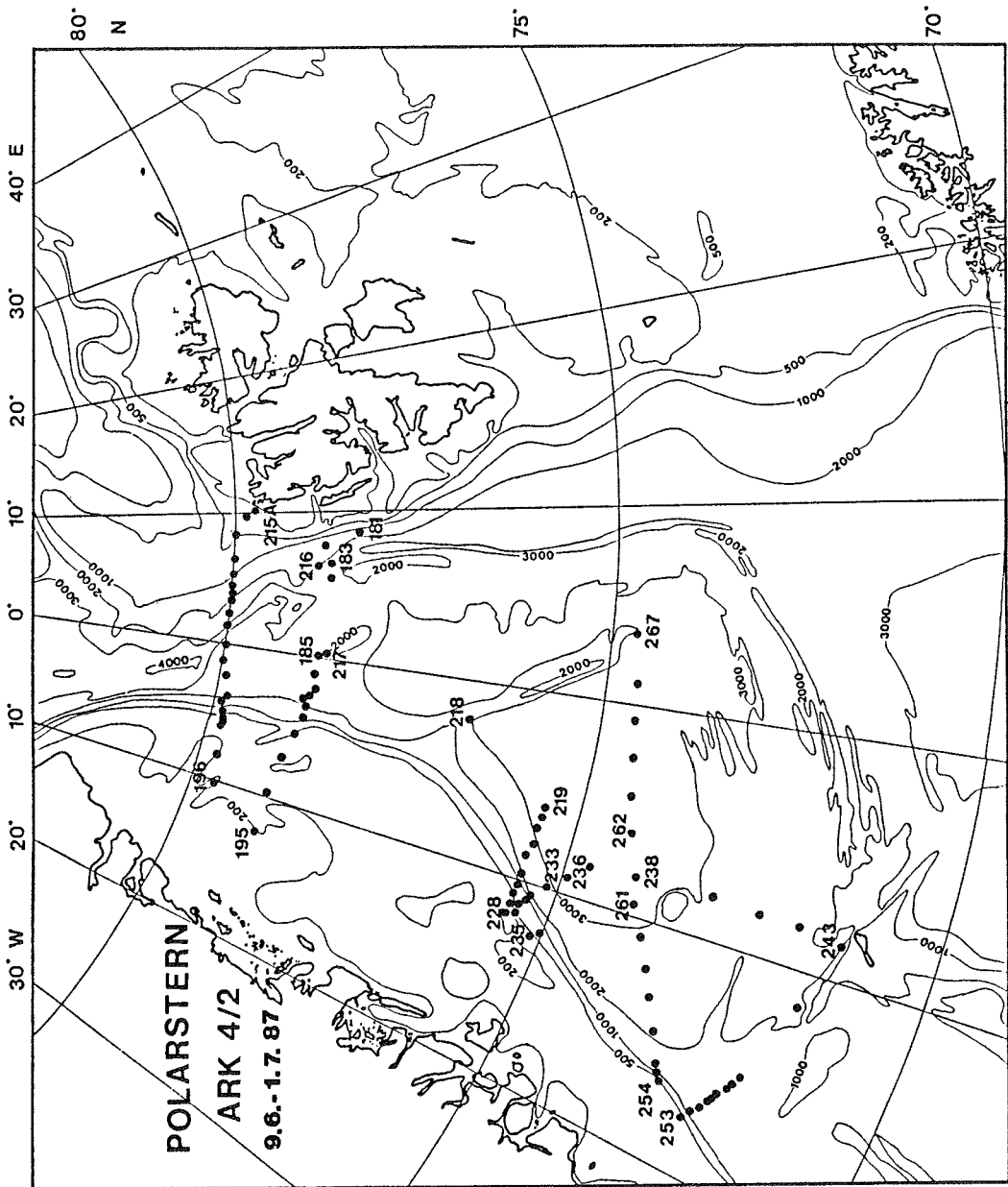

Fig.1 Station map ARK IV/2

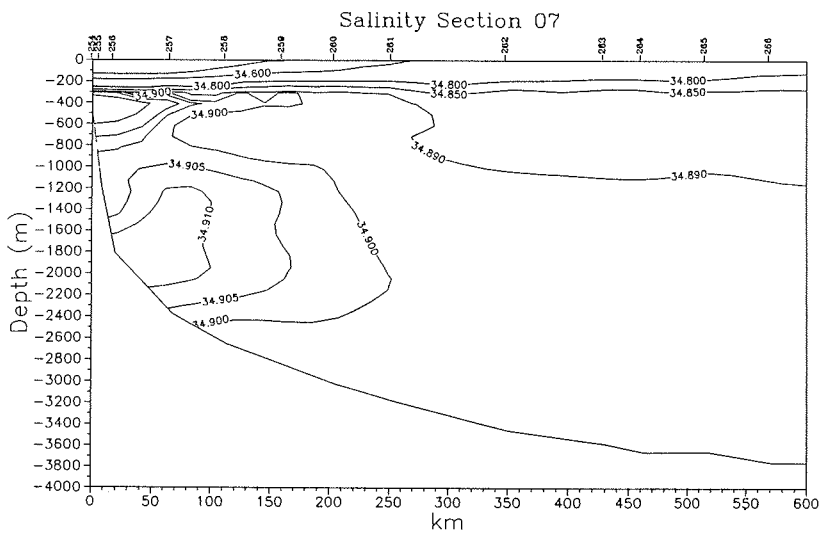
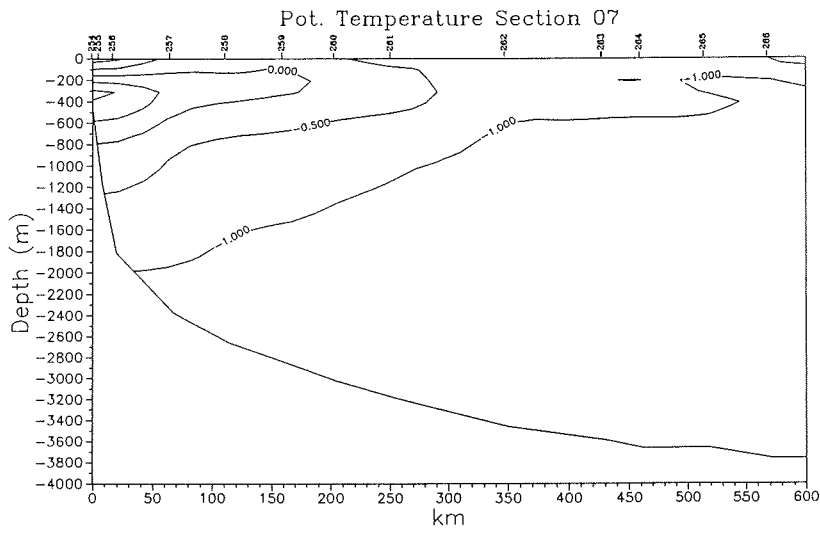

Fig. 3

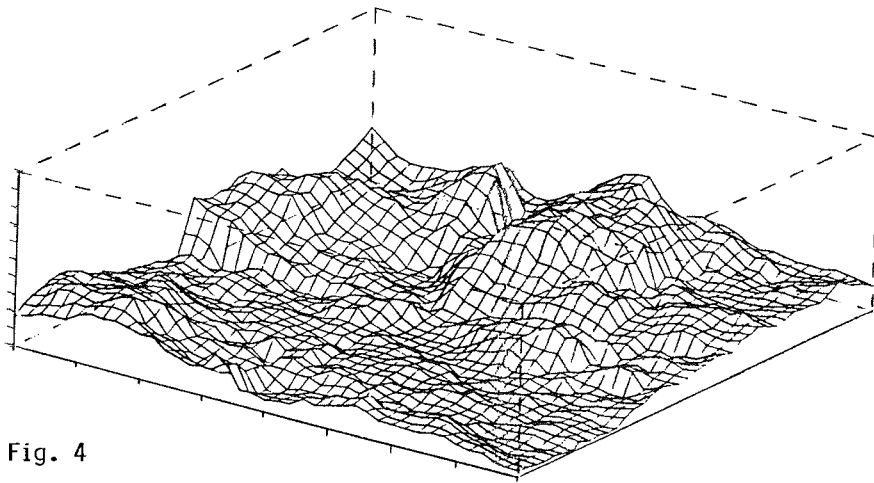

Fig. 4

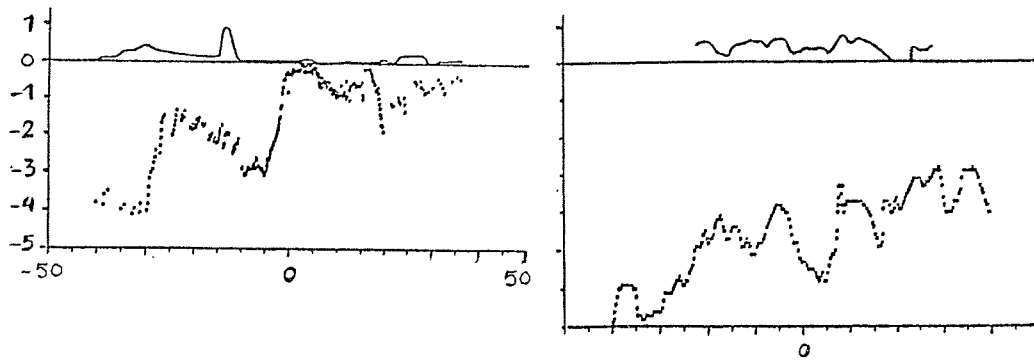

Fig. 5

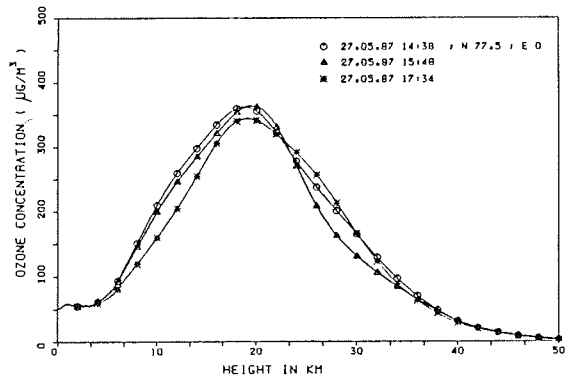

Fig. 6a

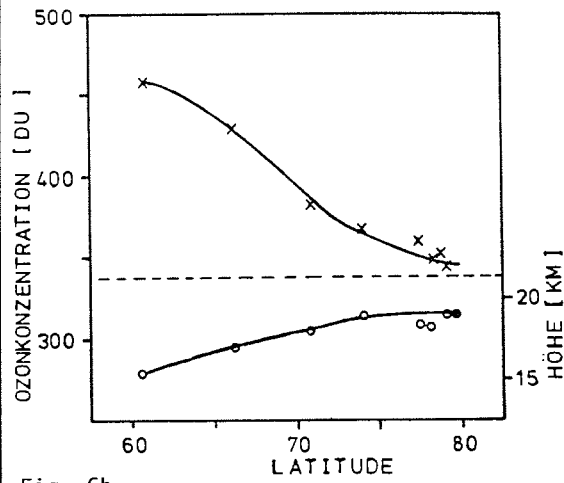

Fig. 6b

List of tables:

Table 1: Station list ARK IV/2.

Table 2: Summary of Ice Reconnaissance Flights.

Table 3: Summary of Ice Station Work.

Table 4: Bacteria-density in Fram Strait and in the western Greenland Sea.

Table 5: Station summary for phytoplankton work.

Table 6: Station summary for plankton community and exosystem dynamics work.

Table 1

Station List Cruise Nr. 11, Arctic IV/2, Longyearbyen-Tromsø

Date 1987	Station No.	Time (UTC)		Latitude	Longitude	Depth (m)	Activity
		Start	End				
09.06	181	15.31	17.16	78 21.7 N	08 41.3 E	1633	MREC-005
09.06	182	21.04	22.31	78 50.7 N	07 59.7 E	1021	MREC-FS-7C
10.06	183	00.40	01.55	78 43.8 N	06 23.3 E	1900	MREC-FS-6C
10.06	184	02.53	04.04	78 42.7 N	05 36.9 E	2555	MREC-012
10.06	185	11.15	00.12	78 48.2 N	00 00.2 E	2560	MREC-006, SD, FL, BRO(2), MU, BO(2), SBO, BAG, CTD, NEU, PLA
11.06	186	01.44	03.35	78 49.1 N	01.01.8 W	2547	SD, FL, PLA, BO, BRO(3)
11.06	187	05.20	06.55	78 47.7 N	02 02.2 W	2719	FL, CTD, PLA, BO, BRO
11.06	188	07.55	08.03	78 49.4 N	02 32.1 W	2629	CTD, FL
11.06	189	09.18	11.28	78 52.7 N	02 59.9 W	2522	FL, SD, PLA, CTD, BRO, BO, ICE-CO
11.06	190	12.40	12.47	78 51.2 N	03 30.5 W	2285	CTD, FL
11.06	191	14.30	15.48	78 51.0 N	04 02.8 W	1895	FL, SD, PLA, CTD, ICE-SU
11.06	192	18.55	22.48	78 55.5 N	05 17.8 W	974	MREC-FS-1C, BO(2)
12.06	193	03.34	04.28	78 59.1 N	07 01.1 W	264	FL, CTD, SD, BO, PLA(2)
12.06	194	23.07	24.00	79 09.6 N	09 48.7 W	167	SD, FL, PLA, CTD, BO
13.06	195	06.44	10.40	78 59.5 N	12 24.6 W	149	FL, SD, PLA, MU, CTD, BRO(2), BO, ICE-CO
13.06	196	18.56	19.39	79 45.4 N	10 06.4 W	153	CTD
14.06	197	00.26	00.51	79 49.1 N	07 59.7 W	209	CTD, PLA
14.06	198	03.42	04.25	79 50.1 N	05 58.6 W	297	CTD, PLA
14.06	199	05.42	06.42	79 49.5 N	05 32.2 W	494	CTD
14.06	200	08.00	09.01	79 49.4 N	05 18.2 W	790	CTD
14.06	201	11.15	12.31	79 50.6 N	04 45.9 W	1401	CTD, PLA
14.06	202	14.00	15.43	79 51.4 N	04 19.0 W	1760	CTD, PLA, ICE-SU
14.06	203	18.03	21.24	79 50.5 N	03 40.9 W	2209	CTD(2), PLA, ICE-SU
15.06	204	03.25	05.47	79 55.7 N	02 19.8 W	2728	CTD, PLA
15.06	205	10.25	13.25	80 01.6 N	01 06.9 W	2726	CTD, PLA(3), ICE-SU, ICE-CO, ICE-SS
15.06	206	15.30	18.15	80 00.8 N	00 02.7 E	2653	CTD, PLA, ICE-SS
15.06	207	20.24	22.40	80 00.0 N	01 40.8 E	2891	CTD, PLA
16.06	208	00.01	04,23	80 00.0 N	02 29.1 E	2693	FL, SD, PLA, BO(2), BRO(3), SBO, CTD, MU
16.06	209	06.08	08.02	79 59.4 N	03 48.5 E	2210	CTD, PLA
16.06	210	09.00	12.06	80 00.1 N	03 59.7 E	1806	BRO, PLA, FL, CTD, BO(2)
16.06	211	13.23	14.40	79 59.8 N	04 29.4 E	1397	CTD
16.06	212	16.06	17.51	79 59.8 N	05 26.1 E	996	CTD, SD, PLA, BO
16.06	213	19.04	20.42	80 00.0 N	06 31.6 E	803	FL, SD, PLA, BO

16.06	214	22.49	00.12	80 00.0 N	08 25.1 E	495	BRO(2), CTD FL, SD, PLA, BC
17.06	215	01.59	03.44	79 49.8 N	09 47.0 E	435	BRO, CTD BRO, PLA, BRO, BO, SBO, CTD
17.06	215A	04.37	05.20	79 43.4 N	10 08.2 E	151	DR
17.06	216	14.35	18.22	78 53.4 N	06 42.6 E	1657	MDEP-016, CTD, PLA
18.06	217	01.13	05.25	78 45.9 N	00.07.9 E	2544	MDEP-015, CTD
18.06	218	17.14	20.42	76 40.7 N	02 06.4 W	2645	MDEP-017, CTD, PLA(2)
19.06	219	07.10	09.27	75 30.0 N	05 59.6 W	3495	FL, PLA, CTD, MU, BRO, SBO, BO(2)
19.06	220	10.48	11.41	75 30.4 N	06 40.2 W	3414	FL, SD, PLA, BO, CTD
19.06	221	12.43	13.33	75 31.2 N	07 12.9 W	3316	FL, SD, PLA, CTD, BO
19.06	222	14.56	16.01	75 29.6 N	07 57.1 W	3188	FL, SD, PLA, CTD, BO(2)
19.06	223	18.25	23.18	75 33.3 N	08 48.8 W	2629	FL, SD, PLA, BO CTD, BRO, SBO, BAG, MU, ICE-CO
20.06	224	00.58	01.45	75 34.0 N	09 38.3 W	2046	FL, SD, CTD, PLA(2)
20.06	225	03.15	04.01	75 34.7 N	10 14.2 W	1665	FL, SD, PLA(2), BO, CTD
20.06	226	05.19	06.21	75 35.4 N	10 45.9 W	1283	FL, CTD, PLA(2)
20.06	227	08.20	13.22	75 34.9 N	11 22.6 W	747	FL, SD, PLA, BO CTD, BRO, SBO, MU, BRO, BAG, D ICE-SU, ICE-CO, ICE-SS
20.06	228	14.30	17.40	75 33.4 N	11 37.9 W	350	MDEP-AWI 401, CTD, BRO
20.06	229	18.50	19.57	75 30.3 N	11 25.3 W	799	CTD, PLA
20.06	230	21.00	02.32	75 29.9 N	11 07.3 W	1275	MDEP-AWI 402, CTD, PLA
21.06	231	03.55	05.45	75 26.7 N	10 47.0 W	1822	CTD, BRO
21.06	232	06.48	08.56	75 22.8 N	10 40.6 W	2203	CTD
21.06	233	11.32	17.53	75 14.3 N	09 57.1 W	2920	MDEP-AWI 403, CTD, PLA, ICE-CO, ICE-SS
21.06	234	05.18	10.18	75 04.7 N	12 09.2 W	1263	MDEP-AWI 404, CTD, PLA
22.06	235	11.58	12.54	75 09.4 N	12 27.6 W	403	BRO, BAG, PLA
22.06	236	22.16	01.03	74 59.9 N	09 00.4 W	3321	FL, BO, CTD, PLA
23.06	237	03.25	05.54	74 44.0 N	08 00.2 W	3395	CTD, PLA
23.06	238	09.25	12.23	74 10.0 N	08 00.0 W	3309	CTD, PLA
23.06	239	15.12	17.59	73 35.1 N	08 00.0 W	3286	BO, PLA, CTD
23.06	240	21.20	01.35	73 04.0 N	08 01.1 W	2668	MDEP-GS-3, CTD
24.06	241	05.36	10.03	72 28.0 N	08 10.5 W	2499	MDEP-GS-2, CTD
24.06	242	12.58	20.37	71 56.1 N	08 21.1 W	2466	MDEP-GS-1, CTD, SD, PLA, BRO, BO FL, BAG
25.06	243	00.08	02.34	71 21.0 N	08 36.1 W	2242	CTD, PLA, SD, BO
25.06	244	08.15	10.04	71 40.1 N	11 25.8 W	2230	CTD
25.06	245	15.54	17.26	71 59.9 N	14 59.7 W	1338	SD, FL, BO, BRO, CTD, PLA(2), MU,

25.06	246	18.31	19.43	72 04.5 N	15 20.9 W	1215	SBO
25.06	247	21.09	22.21	72 08.5 N	15 43.2 W	1292	CTD, PLA, BO, FL
25.06	248	23.34	03.18	72 13.4 N	16 04.3 W	1450	FL, BO(2), CTD
26.06	249	04.15	05.11	72 17.2 N	16 27.9 W	1328	CTD, PLA, BO,
26.06	250	06.00	07.40	72 14.6 N	16 16.0 W	1356	FL, BRO, BAG
26.06	251	09.31	10.41	72 22.1 N	16 47.0 W	1256	BO, FL, PLA, CTD
26.06	252	12.00	12.47	72 26.6 N	17 09.5 W	908	BO, FL, PLA,
26.06	253	14.18	18.38	72 29.8 N	17 31.0 W	315	CTD, BRO, SBO,
26.06	254	23.08	23.51	72 59.9 N	16 30.4 W	465	MU(2)
27.06	255	00.56	02.06	73 02.3 N	16 18.2 W	1187	CTD, BO, FL
27.06	256	03.15	04.44	73 04.9 N	15 58.4 W	1815	BO, FL, CTD,
27.06	257	08.00	09.57	73 17.0 N	14 39.0 W	2376	SD, PLA
27.06	258	13.17	15.51	73 27.3 N	13 19.3 W	2656	CTD, PLA, SD,
27.06	259	19.10	21.20	73 40.2 N	11 59.4 W	2850	BO, BRO, SBO,
28.06	260	00.17	02.26	73 51.9 N	10 45.4 W	3031	MU, BAG, DR,
28.06	261	05.12	07.22	74 02.1 N	09 19.8 W	3185	ICE-CO, ICE-SS,
28.06	262	11.31	15.02	74 17.0 N	06 15.2 W	3459	ICE-SU
28.06	263	17.33	20.19	72 24.0 N	04 25.1 W	3588	CTD, ICE-CO
28.06	264	23.00	03.16	74 30.0 N	02 35.2 W	3661	CTD
29.06	265	06.18	08.57	74 35.0 N	00 45.3 W	3661	CTD, BO
29.06	266	12.20	14.57	74 38.0 N	01 04.4 E	3796	CTD
29.06	267	20.15	20.44	74 42.1 N	03 45.1 E	3626	CTD, PLA, BO(2)

BAG	Grab sampler
BO	Bongo net
BRO	Rosette (6x30)
CTD	CTD + Rosette (24x5)
DR	Dredge
FL	FLuorometer
ICE-CO	Ice coring
ICE-SS	Ice scanning sonar
ICE-SU	Ice surface sampling
MDEP	Mooring deployment
MREC	Mooring recovery
MU	Multi net
NEU	Neuston net
PLA	Micro net (plankton net)
SBO	Closing bongo
SD	Secchi disk

Table 2

ARKTIS IV/1 - ARKTIS IV/2

Helicopter Ice Reconnaissance Missions

Date	Time	Reference
28 MAY 1987	1053-1123 0.5 HRS	Figure 3
30 MAY 1987	1905-2014 1.2 HRS	Figure 4
31 MAY 1987	0702-0824 1.4 HRS	Figure 5
01 JUN 1987	1317-1428 1.2 HRS	Figure 6
01 JUN 1987	1730-1830 1.0 HRS	Figure 7
02 JUN 1987	0919-0951 0.5 HRS	Figure 8
02 JUN 1987	1352-1415 0.4 HRS	Figure 8
03 JUN 1987	0820-0922 1.0 HRS	Figure 9
12 JUN 1987	1245-1352 1.1 HRS	Figure 10
12 JUN 1987	2030-2103 0.6 HRS	Figure 11
13 JUN 1987	0833-0928 0.9 HRS	Figure 12

Table 3

ARKTIS IV/1- ARKTIS IV/2

General Ice Station Information

<u>DATE</u>	<u>ICE TYPE</u>	<u>SNOW DEPTH</u>	<u>FW (%)*</u>
29 MAY 19887	MY	.23 M	0
29 MAY 1987	MY	.35 M	0
31 MAY 1987	FY	.105 M	0/0.7
01 JUN 1987	MY	.37 M	1.6/3
01 JUN 1987	FY	.67 M	0/1
03 JUN 1987	FY	.14 M	3/1
03 JUN 1987	FY	.13 M	2
11 JUN 1987	MY	.27 M	N/A
14 JUN 1987	MY	.31 M	N/A
14 JUN 1987	MY	.33 M	0
15 JUN 1987	FY	.21 M	0
15 JUN 1987	FY	.16 M	0/0.25
20 JUN 1987	MY	.22 M	0.006/2.9
21 JUN 1987	MY	.45 M	0/0.14
26 JUN 1987	MY	.07 M	0/1.7

(*FW: free water content of snow in percent)

Station Data Collected

1. Snow Depth
2. Free Water Content of Snow
3. Snow Density
4. Temperature near surface and at ice/snow interface
5. Grain Size
6. Structure (presence of icelayers and crusts)
7. Nature of snow/ice interface (wet, dry, slush)
8. Roughness of snow/ice interface
9. Surface roughness on the microscale

Table 4:

Bacteria-density in Fram Strait and in the western Greenland Sea.

Station No.	Position	Depth to bottom	Sampling depth	Colonies/100ml seawater	MPN/100ml seawater	Colonies/1cm ³ sediment
185	78°42,2'N; 00°00,2'E	2560	25	2,5·10 ⁴	348·10 ⁴	0,52·10 ⁴
			200	1,6·10 ⁴	33·10 ⁴	
			1000	2,3·10 ⁴	17·10 ⁴	
195	78°59,5'N; 12°24,6'W	149	25	0,35·10 ⁴	46·10 ⁴	18,7·10 ⁴
			135	0,14·10 ⁴	5·10 ⁴	
223	75°33,3'N; 08°48,8'W	2629	25	0,48·10 ⁴	348·10 ⁴	1,2·10 ⁴
			200	0,47·10 ⁴	5·10 ⁴	
			1000	0,71·10 ⁴	-	
227	75°34,9'N; 11°22,6'W	747	25	0,93·10 ⁴	49·10 ⁴	4,7·10 ⁴
			200	0,32·10 ⁴	7·10 ⁴	
235	75°09,4'N; 12°27,6'W	403	25	0,93·10 ⁴	84·10 ⁴	2,1·10 ⁴
			200	1,60·10 ⁴	23·10 ⁴	
242	71°56,1'N; 08°21,1'W	2466	25	1,1·10 ⁴	17·10 ⁴	0,2·10 ⁴
			200	1,9·10 ⁴	8·10 ⁴	
			1000	1,5·10 ⁴	-	
248	72°13,4'N; 16°04,3'W	1450	25	1,1·10 ⁴	542·10 ⁴	0,83·10 ⁴
			200	1,1·10 ⁴	8·10 ⁴	
			1000	6,2·10 ⁴	13·10 ⁴	
253	72°29,8'N; 17°31,0'W	315	25	0,46·10 ⁴	70·10 ⁴	1,1·10 ⁴
			200	0,33·10 ⁴	70·10 ⁴	

Table 5

station	station- type	ice- cover	surface temp.	secchi- depth	primary production measurement and phytopl. distrib.	POC PON	¹⁴ C- pattern	chem. analyses
East transect:								
3	ice- edge	3/10	1,3	11	0, 5, 8, 12, 19, 30	0, 5	0, 5	x
5	front?	5/10	1,3	6	0, 2, 4, 7, 11, 16	0, 2	-	-
7	ice	7/10	-1,3	14	0, 6, 11, 17, 27, 41	0, 6	-	-
3	small polynya	7/10	-1,5	26	0, 11, 18, 29, 46, 70	0,11	0,11	x
1	ice	8/10	-1,6	25	0, 11, 18, 29, 46, 70	0,11	-	-
3	ice	9/10	-1,6	25	0, 11, 18, 29, 46, 70	0,11	-	-
4	ice	9/10	-1,6	12	0, 5, 9, 13, 21, 33	0, 5	-	-
5	polynya	2 to 3/10	-1,2	17	0, 7, 12, 19, 30, 46	0, 7	0, 7	x
South transect:								
3	ice- free	0	3,0	5	0, 2, 4, 6, 9, 14	0, 2	0, 2	x
0	ice- free	0	1,3	12	0, 5, 9, 13, 21	0, 5	-	-
3	ice- free	0	3,1	6	0, 2, 4, 7, 11, 27	0, 2	-	-
4	ice- free	0	2,5	8	0, 3, 6, 9, 14, 22	0, 3	-	-
5	ice- free	0	3,4	5	0, 2, 4, 6, 9, 14	0, 2	0, 2	x
West transect:								
3	ice- free	0	0,4	9	0, 4, 6, 10, 16, 27	0, 4	0, 4	x
0	ice- free	0	-0,8	10	0, 4, 7, 11, 18, 27	0, 4	-	-
2	ice- edge(?)	3 to 4/10	-1,0	10	0, 4, 7, 11, 18, 27	0, 4	-	-
3	ice	6 to 7/10	-1,0	12	0, 5, 9, 13, 21, 33	0, 5	0, 5	x
4	ice	7/10 (?)	-1,0	12	0, 5, 9, 13, 21, 33	0, 5	-	-
5	ice	7/10	-1,2	12	0, 5, 9, 13, 21, 33	0, 5	-	-
5	ice	5/10	-1,3	16	0, 7, 11, 18, 28, 43	0, 7	-	-
7	ice	5/10 (?)	-1,3	15	0, 6, 11, 17, 27, 41	0, 6	0, 6	x
"Cyanophyte"- Station:								
2	ice- free	0	3,0	6	0, 2, 4, 7, 11, 16	0, 2	0, 2	x
North transect:								
5	ice- free	0	1,3	10	0, 4, 7, 11, 18, 28	0, 4	0, 4	x
5	ice- free	0 to 1/10	0,2	13	0, 5, 9, 15, 23, 35	0, 5	-	-
7	ice- free	0 to 1/10	1,1	10	0, 4, 7, 11, 18, 27	0, 4	-	-
3	ice- free	1/10	0,8	11	0, 5, 8, 12, 19, 30	0, 5	-	-
9	ice- free	1/10	-0,6	14	0, 6, 10, 16, 25, 38	0, 6	-	-
0	ice- free	1/10	0,3	11	0, 5, 8, 12, 19, 30	0, 5	0, 5	x
1	ice	9/10	-1,1	12	0, 5, 9, 13, 21, 33	0, 5	-	-
2	ice	9/10	-1,2	16	0, 7, 11, 18, 28, 43	0, 7	-	-
3	ice	5 to 6/10	-0,6	10	0, 4, 7, 11, 18, 27	0, 4	0, 4	x

b.5 : Station list of ARK IV/2

Table 6

St #	Bacteria Ultra- plankton	Chloro phyll a	Phytopl net samples	Zoopl distr	E x p e r i m e n t a l w o r k			
					Grazing Nanopl	Ammonia uptake	Respiration zooplankton	Excretion zooplankt
185	x	x	x	x	x	x		x
186	x		x					
187		x	x					
189	x	x	x	x	x			
191	x		x					
193			x					
194	x		x		x			
195	x	x	x	x	x			x
205			x					
206			x					
207			x					
208	x	x	x		x			
209			x					
210	x	x	x		x			
212			x					
213	x		x		x	x		
214	x				x			
215	x	x	x		x		x	x
219	x	x	x	x	x	x	x	x
220			x					
221	x		x		x			
222			x					
223	x	x	x	x	x		x	x
224			x					
225	x		x		x			
226			x					
227	x	x	x	x	x	x	x	x
242	x		x					
245	x	x	x	x	x	x	x	x
246			x					
247			x					
248			x					
249	x		x					
250	x	x	x	x	x	x	x	x
251			x					
252			x					
253	x	x	x		x	x	x	x

(Explanations of headings see next page!)

Explanation of headings:

Bacteria/Ultraplankton:

Cell counts of bacteria, auto- and heterotrophic ultraplankton from 3 light depths (50%, 15%, 1%)

Chlorophyll a:

Chlorophyll a, particulate carbon and nitrogen, Utermöhl sample for species analysis from 6 light depths (100%, 50%, 30%, 15%, 5%, 1%) and 50m and 75m.

Phytopl net samples:

Net samples with a 20µm plankton net from the upper 20m, formalin preserved

Zoopl distr:

Multinet samples (200µm) from 5 depth intervals (100-60-45-30-15-0m) for biomass estimation (dry weight and organic matter) and species composition

Grazing nanopl:

Grazing of heterotrophic nanoflagellates on bacteria in samples from 50% light depth

Respiration zooplankton:

Community respiration in 4 size classes (<20µm, 20-200µm, 200-2000µm, >2000µm), integrated for the euphotic zone

Excretion zooplankt:

Community excretion of ammonia and phosphate in 4 size classes (<20µm, 20-200µm, 200-2000µm, >2000µm), integrated for the euphotic zone

CRUISE LEG ARK IV/3

July 4 - September 3, 1987, Tromsø - Hamburg

3.1. ÜBERSICHT ÜBER DIE WICHTIGSTEN ERGEBNISSE DER EXPEDITION

SUMMARY OF IMPORTANT SCIENTIFIC OBSERVATIONS

(J. Thiede, GEOMAR, Chief Scientist)

The ARK IV/3 expedition of RV POLARSTERN during the summer of 1987 succeeded in bringing a modern, mobile oceanographic research platform with advanced laboratory facilities into the central part of the Eurasian Basin of the Arctic Ocean, (Figs. 1,2). Prior to this cruise, most knowledge about the eastern Arctic Basin came from remote sensing techniques, Nansen's FRAM expedition in 1893-1896, observations from ice camps and stations operated by the Soviets and Americans, and explorations by submarines. The northernmost position of POLARSTERN was 86° 11' N 22° 04' E, further north than was attained on Nansen's FRAM expedition which similarly was devoted to an extensive multidisciplinary research expedition. Soviet ice breakers have managed to penetrate the pack ice to the North Pole.

¹

The ARK IV/3 scientific party of 57 members included meteorologists, physical and chemical oceanographers, marine biologists, geophysicists and geologists who carried out a multitude of research programs. Data and samples have been analyzed to a limited extent on board POLARSTERN, and will be further analyzed or investigated in onshore laboratory facilities in many European and North American institutions. At this preliminary stage of analysis the following important scientific discoveries can be reported regarding the deep-sea Nansen Basin north of the continental margin of Svalbard, the Nansen-Gakkel Ridge and the Amundsen Basin between the Lomonosov and the Nansen-Gakkel Ridges:

- The Arctic Ocean is one of the last, poorly investigated and poorly known deep-sea areas of the world ocean. POLARSTERN has for the first time collected detailed and precisely positioned bathymetric and gravimetric data from the continental margin north of Svalbard, the adjacent abyssal plain, the southern and northern flanks of the Nansen-Gakkel Ridge as well as from its central valley. Published bathymetric maps are generally inaccurate, and the well-expressed midocean ridge valley is deeper in the area investigated than was previously known. The northern shoulder of the Nansen-Gakkel Ridge is much deeper than its southern counterpart.

Heat flow was found to be extremely high in the central part of Nansen-Gakkel Ridge median valley.

- Basement rocks were sampled in the central part of the ridge. In one box core we collected large pieces of hydrothermally and possibly tectonically altered basalts

¹ A detailed description of scientific programs and preliminary findings of this expedition and proposals for future research are published in J. Thiede (ed.) and the ARK IV/3 Scientific Party (1988): Scientific cruise report of Arctic expedition ARK IV/3, Berichte zur Polarforschung, AWI vol. 43. Core descriptions, water content measurements and thermal conductivities are reported by R. Spielhagen and S. Pfirman (eds.) and the Geoscientific Participants (1988) in the Geoscientific report on the ARK IV/3 expedition of the PFVS POLARSTERN Summer 1987 to the central eastern Arctic Basin, Berichte 24, Geologisch-Paläontologisches Institut und Museum, Christian-Albrechts-Universität, Kiel.

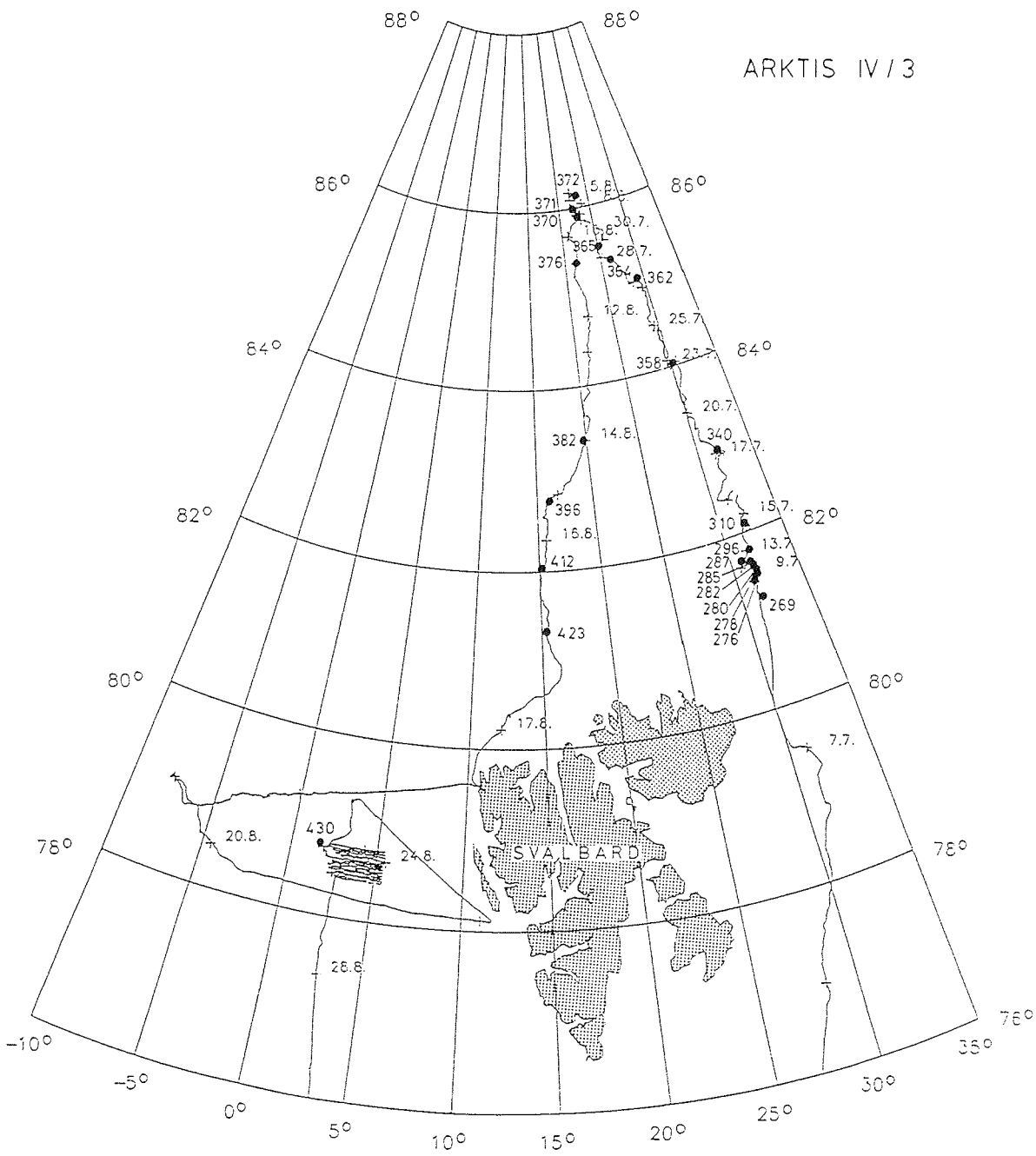

Fig.1 Expeditionsroute ARK IV/3 PFVS POLARSTERN Sommer 1987.

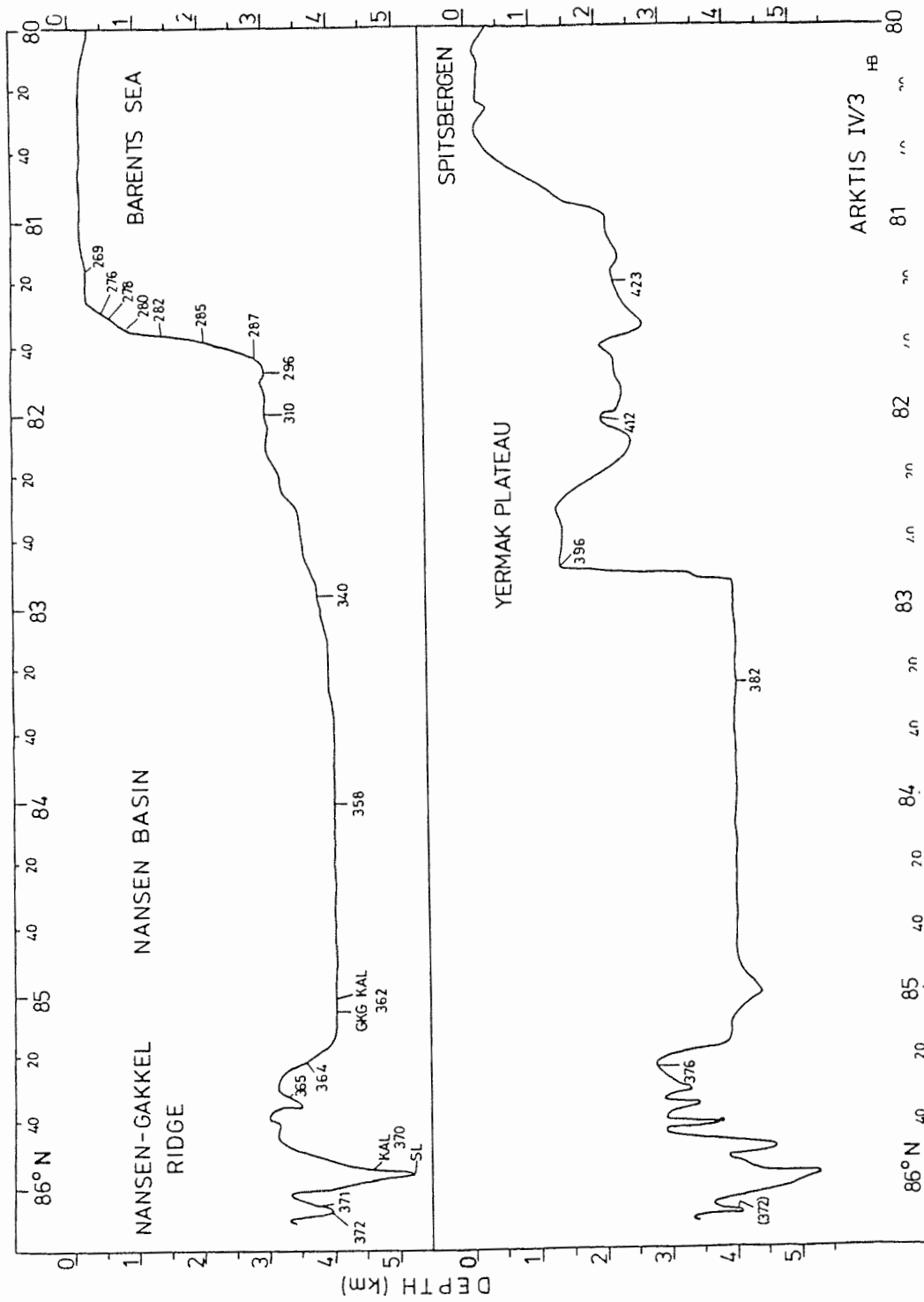

Fig.2 Verteilung der wissenschaftlichen Stationen im bathymetrischen Profil.

under basaltic rubble covered by a thin sediment layer. They represent the first and only sample of undisturbed basement rocks from the entire Eurasian Basin; at the same time they are the only sample from very young oceanic crust of the world's slowest spreading midocean ridge.

- A transect of sediment samples was obtained from the continental margin north of Svalbard across the Nansen-Gakkel Ridge. Most cores are large diameter (30 x 30 cm) and are up to 8 m long. On the way back to the Norwegian-Greenland Sea, stratified sediments were cored on the Yermak Plateau and in the central Fram Strait. Stratigraphic (bio-, litho- and magnetostratigraphic) data suggest that most of these sediments were deposited during the past few hundred thousand years. The resulting sedimentation rates are comparable to those of the Fram Strait area and of the Norwegian-Greenland Sea, and are an order of magnitude higher than in the central Arctic Ocean.
- The sediments of the cores consist in general of dark gray to yellowish brown silty and sandy clays with clastic terrigenous (mainly quartz and clay) minerals as their main components, but with minor biogenic, mostly calcareous (coccoliths, planktonic foraminifers) materials. Some sediments display a characteristic layering which might be a response to Late Quaternary glacial-interglacial climatic fluctuations. Sediments from the Barents Abyssal Plain seem to reflect turbiditic sediment input from the adjacent continental margin. Deposits from the Nansen-Gakkel Ridge and its median valley contain large amounts of hydrothermal sediment components. All sediments except those from the Fram Strait contained surprisingly little coarse ice-rafted material.
- Based on 3.5 kHz and box core samples surficial deposits can be subdivided into major provinces reflecting several sedimentary regimes, which differ in their sediment components, their sedimentary structures and their pore water regime: a) outer continental margins north of Svalbard, b) Barents Abyssal Plain, c) Nansen-Gakkel Ridge and its median valley, and d) Yermak Plateau and Fram Strait. Reworking seems to control important aspects of the sediment properties in many topographically elevated areas.
- Planktonic and benthic organisms respond in composition and quantity to a major boundary between Atlantic and Arctic water masses close to 83-84° N. This boundary is located far north of the southern border of the ice pack, but is also clearly reflected by planktonic and benthic foraminiferal distributions, productivity and copepod assemblages. The boundary appears to separate the shelf-influenced southern part of the basin, from the northern, deep Arctic environment.
- The first transect of oceanographic stations into the central Eurasian Basin has allowed definition of important hydrographic and chemical traits of water mass structure and distribution. The core of the Atlantic waters entering the Arctic follows the continental margin north of Svalbard forming a well developed boundary current.

The CTD-data for the top and intermediate layers of the water column show the expected distribution of cold and fresh polar surface layers, increasing in thickness towards the north to approximately 200 m. The relatively warm and salty Atlantic signal is reduced from 1.9° C north of the Barents shelf break to approximately 1.2° C over the Nansen-Gakkel Ridge. Multiple temperature maxima occur between 200 m and 500 m.

- Near and over the Nansen-Gakkel Ridge at 86° N several layers with noticeable gradients in hydrographic properties indicate a very active region.

- On the basis of the only previous study of Freons in the Nansen Basin there was an indication of the presence of significant levels of Freon. Perhaps the single most unexpected finding of the ARK IV/3 section was the presence of a large pool of water in the centre of the Nansen Basin (below 3,000 m) with undetectable levels of F-11, F-12 and methyl chloroform and the presence of carbon tetrachloride. This indicates that the age of the deep water is at least several decades.
- Freons were found to be significantly above the detection limit both at the southern boundary of the Nansen Basin and in the vicinity of the Nansen-Gakkel Ridge, presumably the signature of a boundary current. The intermediate and near-surface waters were characterized by much higher concentrations of all halocarbons, with significant amounts of interleaving and structure observed at many stations. The inventory of Freon in the Nansen Basin water column is much larger than was observed in the central Canada Basin indicative of more rapid ventilation of the water masses.
- The entire investigated transect of the Nansen Basin was covered by the thick Arctic ice pack (up to several meters thick) which was highly variable in composition, age and appearance. The area north of 83° N and south of the Nansen-Gakkel Ridge is characterized by one of the major branches of the Transpolar Ice Drift (the "Siberian Branch", first identified by the historical famous FRAM drift) where an important source for ice is the Siberian shelf. The path of the ice movements in the investigated area is now monitored by ARGOS drifting buoys deployed by POLARSTERN and previous expeditions.
- Much of the investigated ice is very "dirty" containing considerable, but variable amounts of particulate material of presently unknown origin. "Dirty" ice surfaces seem to be associated with multiyear ice floes. Extreme material accumulation, affecting more than half of the ice surface, was often associated with regions where surface melting was extensive.
- At almost all sites with dirty ice, material was observed to form small aggregates. These aggregates sometimes accumulated in up to 1 cm thick black layers in meltwater depressions. In some cases round to elongate cohesive sediment accumulations, so-called "mudballs", were found in holes in meltwater ponds and on the ice surface. These "mudballs" were 1-3 cm in diameter and consisted of clay- and silt-sized mineral grains and biogenic material. Similar features were also observed in seafloor sediment samples, both in surface sediments and accumulated in deeper layers.
- Samples of ice-rafted sediment from several sites contained abundant cylindrical and pennate diatoms as well as an unicellular organism containing bright red pigment bodies. This organism is tentatively identified as *Chlamydomonas nivalis*. In several areas it stained patches of the ice red.

3.2. BERICHT ÜBER DEN EXPEDITIONSVERLAUF

Einleitung

Mit einem modernen Forschungsschiff in das zentrale Nordpolarmeer vordringen zu können, hat die Phantasie mariner Polarforscher seit langem fasziniert. Die Erforschung des zentralen Nordpolarmeer ist bisher nur von Flugzeugen und Satelliten, sowie von passiv driftenden Eisinseln oder Schiffen vorangetrieben worden, wobei F. Nansen's berühmte Expedition auf der FRAM in den Jahren 1893-1896 einen einsamen und frühen Höhepunkt dieser Bemühungen darstellt. Ob und welche

Forschungsprogramme von den gewaltigen russischen Eisbrechern und von den nuklear angetriebenen Unterseebooten der östlichen und westlichen Flotten ausgeführt werden und wurden, ist i. A. unbekannt. Nachdem man mit schwedischen und norwegischen Forschungsschiffen (YMER-80, POLARSIRKEL, LANCE) die Randgebiete der östlichen Arktis erreicht hatte, war es daher außerordentlich wünschenswert, mit der vielseitigen POLARSTERN einen Versuch zu unternehmen, möglichst weit in die permanent packeisbedeckten Tiefseebecken des östlichen arktischen Ozeans vorzudringen (Fig. 3), um sie durch eine multidisziplinäre, internationale Forschergruppe auf ihre ozeanographischen, biologischen und geologischen Eigenschaften untersuchen zu lassen.

Nach einer langen Vorbereitungsphase, die vom Alfred-Wegener-Institut für Polar- und Meeresforschung als die für den Einsatz der POLARSTERN verantwortliche Institution koordiniert wurde, wurde für den Sommer 1987 ein 2-monatiger Fahrtabschnitt für Arbeiten in der zentralen östlichen Arktis in das Forschungsprogramm der POLARSTERN eingeplant. Eine 57-köpfige wissenschaftliche Arbeitsgruppe mit Teilnehmern aus 8 europäischen und nordamerikanischen Ländern sollte ein umfassendes Stations-, Beprobungs- und Meßprogramm entlang eines Schnittes vom Kontinentalrand der NE Barentssee nach N in Richtung auf den Nansen-Gakkel-Rücken durchführen. Die physikalischen, chemischen und ozeanographischen Untersuchungen sollten ihren regionalen Schwerpunkt in der Nähe des Kontinentalrandes haben; das Arbeitsgebiet für die geowissenschaftlichen Untersuchungen wurde in die Nähe des mitteleozanischen Rückens (also jenseits der Barents-Tiefsee- Ebene) gelegt; während der gesamten Ausfahrt sollten zusätzlich biologische Untersuchungen durchgeführt werden.

Die geplante Ausfahrt wurde als 3. Fahrtabschnitt der IV. Expedition der POLARSTERN in die Arktis vorgesehen (Ausfahrt ARK IV/3, Anfang Juli bis Anfang September, Tromsø-Hamburg). Aus verschiedenen Gründen sollte die Ausfahrt bereits Anfang September 1987 in Hamburg zu Ende gehen. Dies bedeutete, daß die Ausfahrt jahreszeitlich um etwa 1 Monat zu früh durchgeführt werden mußte und die Expedition die für die Nordpolargebiete günstigste Jahreszeit nur teilweise ausnützen konnte. Die Zeitplanung wurde zusätzlich dadurch erschwert, weil den Vorhersagen über die Eislage nach starke NE Winde sehr viel Eis in die südliche Barentssee drückten. Trotz dieser Bedenken entschied man sich dafür, zunächst zu versuchen, das geplante Arbeitsgebiet anzulaufen. Die Erfolge der Ausfahrt bestätigten dann bald die Richtigkeit dieses Entschlusses. Aus dem Verlauf der Expedition ergab sich, daß nur die Arbeiten entlang des Profils A und in geringem Umfang im Gebiet C (Fig. 3) ausgeführt wurden.

Wochen 27 und 28 (4.-12. Juli 1987)

Nach dem Hafenaufenthalt in Tromsø lief die POLARSTERN am 4. Juli um 12.30 Uhr (lokal) bei verhangenem, kühlem und teilweise regnerischem Wetter zum 3. Fahrtabschnitt der ARKTIS IV-Expedition aus.

Die Fahrt durch die südliche Barentssee verlief bei ruhigem, aber bedecktem Wetter schneller als erwartet. Bereits am späten Nachmittag des 5. Juli trafen wir auf die ersten Eisschollen, die sehr bald zu geschlossenen Eisfeldern zusammenwuchsen, sich nach Norden immer weiter verdichteten, aber das Vorwärtkommen von POLARSTERN aufgrund der weichen Beschaffenheit des Eises zunächst nicht sehr behinderten. In der Nacht zum Montag durchliefen wir eine weite eisfreie Fläche und konnten bei guter Sicht, aber bedecktem Himmel die östlichsten Gipfel von Nordaustlandet sehen. Am Morgen liefen wir eben westlich von Kvitöya vorbei und umgingen vorsichtig eine halbinselförmige Untiefe, die sich westlich von Kvitöya erstreckt, nachdem wir bereits am Vortage eine sehr hoch aufragende Untiefe (25 m) passiert hatten, die nicht auf der von uns benutzten norwegischen Seekarte eingetragen war.

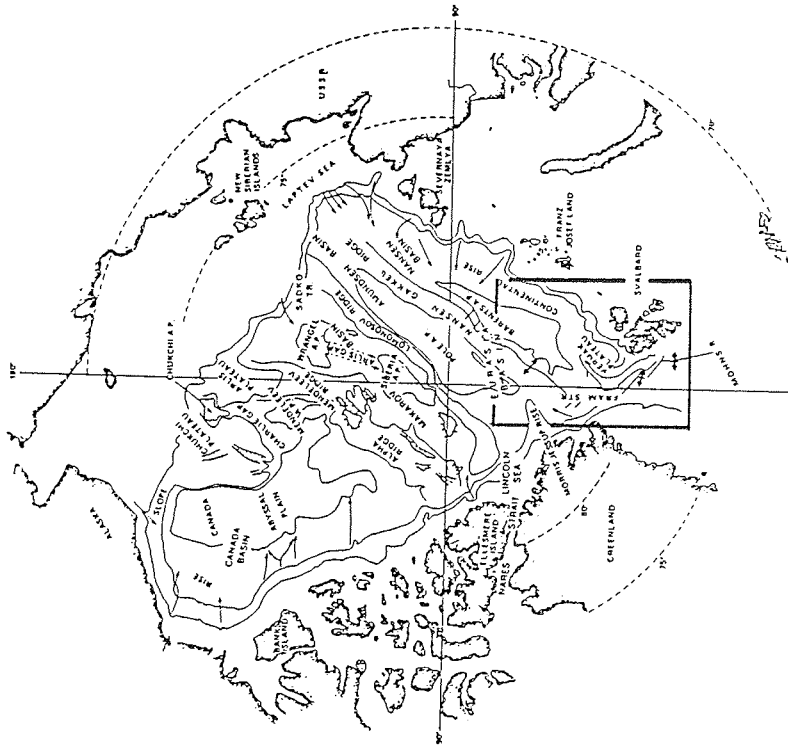
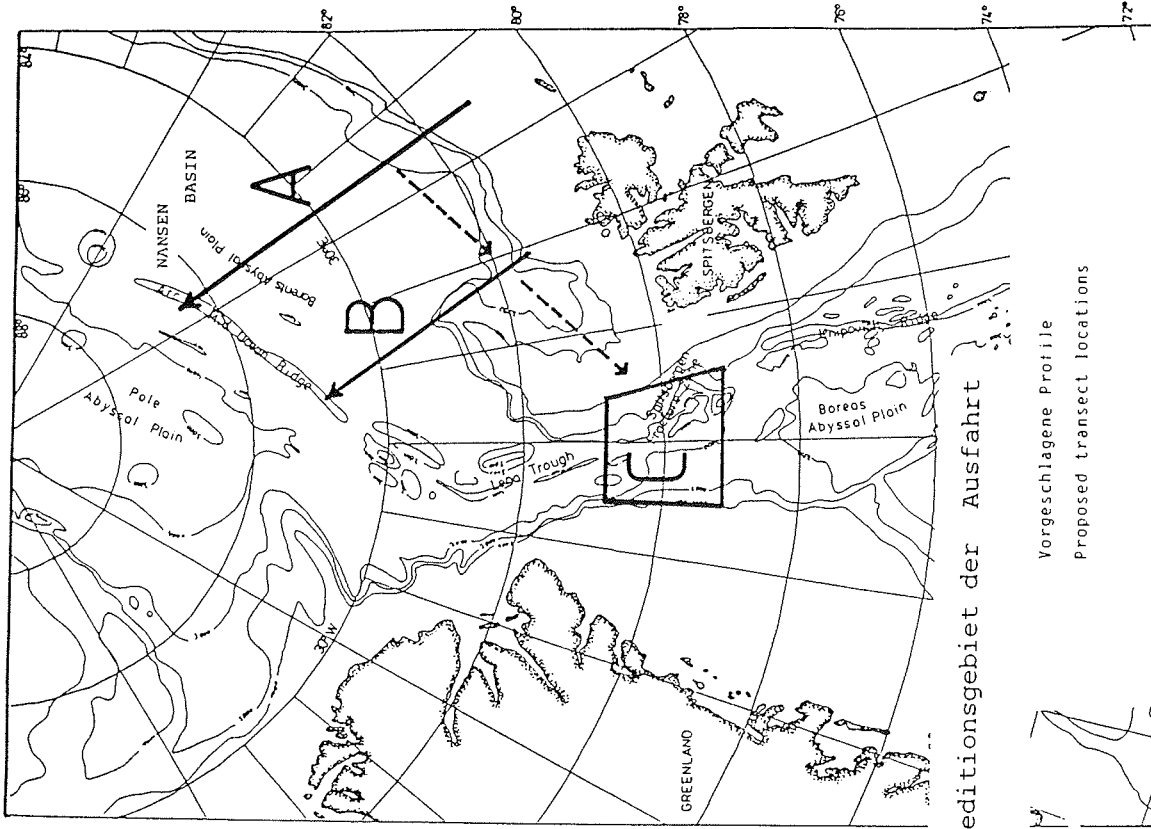

Fig.3 Geplante Arbeitsgebiete und Expeditionsgebiet der Ausfahrt ARK IV/3 des PFVS POLARSTERN.

Geographische Gliederung des Nord-Polarmeeres.
 Umräumte Fläche zeigt das Gebiet für ARKTIS IV/3
 Geography of the Arctic Ocean. Box encloses area
 of interest for Arctic IV/3

Trotz des sich weiter verdichtenden Eises erreichten wir bereits am Dienstag, den 7. Juli gegen 16.00 das Gebiet der ersten Station, wo Ozeanographen, Biologen, Chemiker, Geologen und Geophysiker ihre Arbeit aufnahmen. Die Tage der Anreise waren dazu benutzt worden, die Labore einzurichten, und die erste Phase der sehr intensiven Stationsarbeit entlang des Profiles über den Kontinentalrand nördlich von Kvitöya zu koordinieren. Bisher sind 4 Stationen dieses Profiles mit Beprobung des Eises, der Wassersäule, der planktischen und benthischen Fauna sowie des Meeresbodens erfolgreich abgeschlossen worden, wobei nur der Großkastengreifer etwas Probleme bereitete, weil er zweimal nicht ordentlich auslöste.

Im Laufe des 8. Juli wurde die Eisdecke so dicht und vor allem das Eis so hart, daß die POLARSTERN sich nur noch langsam voranschleichen konnte, z. Zt. sogar nur durch wiederholtes Rammen der durch Eistrüben versteiften Teile der Eisschollen. Die Tage entlang des Schnittes über den Kontinentalrand waren durch besonders intensive Stationsarbeiten geprägt, die alle an Bord vertretenen Disziplinen bis an den Rand der Erschöpfung forderten.

Am Ende der 28. Woche hatten wir 8 Stationen mit umfassenden ozeanographischen, biologischen, chemischen und geowissenschaftlichen Beprobungs- und Messprogrammen abgearbeitet. Die Stationen liegen auf einem Tiefenprofil vom Schelf der Barentssee über den nördlichen Kontinentalrand in die benachbarte Tiefsee. Zwischen den Stationen wurden routinemäßig 3,5-kHz- und SEABEAM-Daten aufgenommen, die uns schnell zeigten, wie unbekannt der Meeresboden dieses schwer zu erreichenden Seegebietes noch ist. Die Sedimentbedeckung war durch starke Fleckenhaftigkeit und relativ hohe Mächtigkeiten jungquartärer toniger Ablagerungen geprägt. Eine detaillierte Beprobung des Eises zeigte, daß es viel feinkörniges klastisches Sedimentmaterial enthält. Ebenso wurden durch diesen Schnitt wichtige ozeanographische Eigenschaften und Gradienten der Randströmungen der arktischen Wassermassen festgestellt und deren regionale Verbreitung erfaßt. Die Planktonfänge waren bisher außerordentlich ergiebig, enthielten auffallend viel Zooplankton, aber wenig Phytoplankton; sie zeichneten sich u. a. durch eine reiche planktonische Foraminiferenfauna aus.

Woche 29 (13.-19. Juli 1987)

Nach Abschluß des intensiven Stationsprogramms über dem Kontinentalrand, der der nördlichen Barentssee vorgelagert ist, setzte die POLARSTERN ihre Fahrt weiter nach Norden fort. Bei wechselhaftem Wetter mit viel Nebel war es zunächst bei dem sehr dichten und harten Eis außerordentlich schwierig, den Kurs nach Norden zu halten. Das sehr dichte und schwierig zu passierende Eis reichte bis 81° 30' N. Erst dann verbesserte sich das Eismal der POLARSTERN wieder, weil Gebiete sehr großflächiger Eisschollen, die nun erreicht wurden, durch relativ leicht passierbare Rinnen voneinander getrennt waren. Sie konnten durch den an Bord befindlichen Helikopter erkundet werden, wodurch ein rasches Fortkommen nach Norden ermöglicht wurde. Die Arbeit an den 3 Stationen dieser Woche wurde durch die leichte Eissituation außerordentlich erleichtert. Das Eis driftete sehr schnell, so daß die POLARSTERN auf jeder Station um mehrere Breitenminuten wieder nach S versetzt wurde.

Bei den großen Wassertiefen (2500-3700 m) zogen sich die komplizierten Beprobungs- und Meßprogramme der verschiedenen Forschergruppen über 20-48 Stunden hin. En route wurden zusätzlich zahlreiche XBT's geworfen, und das bathymetrische Meßprogramm systematisch weiter fortgesetzt. Nach dieser Reise werden die ersten genau positionierten Tiefenverteilungen eines Schnittes über den Kontinentalrand der NE Barentssee vorliegen; es sieht so aus, als ob dieser Kontinentalhang eine wesentlich unruhigere Morphologie hat als auf den verfügbaren Karten dargestellt ist, und daß er z. T. sehr steil in die benachbarte Barents Tiefsee-Ebene abfällt.

Mit den 3 Stationen dieser Woche bei 81° 50' N, 82° 10' N und 83° 00' N entlang 32° 00' E hat die Expedition für alle an Bord vertretenen ozeanographischen Disziplinen einen mit Proben/Daten vollständig dokumentierten Schnitt vom Kontinentalrand NE Svalbards nach N in die benachbarte Barents-Tiefsee-Ebene gewonnen. Alle Beprobungen und Messungen in der Wassersäule waren ein 100%iger Erfolg. Ebenso gelang die Beprobung der Sedimentoberfläche sehr gut. Das Ziehen von Sedimentkernen war hingegen wegen der sehr steilen Morphologie, der daraus resultierenden fleckenhaften Sedimentbedeckung und den fast überall auftretenden sandigen Horizonten sehr schwierig, und es ist zu prüfen, wie vollständig ihre stratigraphische Abfolge ist. Sedimente in den Eiskernen zeigten sehr unregelmäßige, z. T. relativ grobe Korngrößenspektren; es ist bisher unklar, durch welche Prozesse die klastischen Sedimentpartikel in das Eis eingetragen worden sind.

Die Arbeiten dieser Woche wurden durch einen Krankheitsfall überschattet, der nur durch den unermüdbaren Einsatz des Bordarztes und der Krankenschwester, die in Absprache mit Spezialisten an Land ein intensives Behandlungsprogramm zusammenstellten, nicht zur Katastrophe führte. Fehlende oder zur Neige gehende Medikamente wurden auf unsere Bitte am Freitag, den 17. Juli durch ein viermotoriges Patrouillenflugzeug der königlich-norwegischen Streitkräfte in 2 Sendungen in der Nähe der POLARSTERN abgeworfen und dann durch unseren Helikopter eingesammelt, weniger als 24 Stunden, nachdem wir uns mit den norwegischen Behörden in Verbindung gesetzt hatten. Diese für uns absolut notwendige Hilfe wurde über die Rettungszentrale (Redningssentralen) Nordnorwegen in Bodö erbeten und uns sehr schnell und unbürokratisch gewährt. Dem Patienten ging es gegen Ende der Woche den Umständen entsprechend gut, und wir sind den Norwegern außerordentlich zu Dank verpflichtet.

Woche 30 (20.-26. Juli 1987)

Schnell wechselnde Eis- und Wetterverhältnisse sind von der POLARSTERN in dieser Woche vorzüglich gemeistert worden. Die Eisbedeckung wechselte häufig zwischen mehrjährigem, mächtigem altem und einjährigem, leicht zu brechendem Eis. Dank der Helikoptereinsätze war es jedoch immer wieder möglich, auch sehr schmale Rinnen zur Weiterfahrt zu finden. Obwohl die Eismale manchmal sehr gering waren, waren die Eisverhältnisse bisher kein einschneidendes Hemmnis für die Weiterfahrt, vor allem wenn gute Sicht herrschte und das Fortkommen über längere Entfernungen hinweg geplant werden konnte. Daß auch die POLARSTERN an die Grenzen ihrer Leistungsfähigkeit stößt, wenn mächtige Schollen mehrjährigen Eises aneinanderstoßen und die Scherkräfte mehrere Meter hohe Eisrücken aufpressen, zeigte sich beim Anlaufen der Station bei 85° 05' N. Wir hatten beabsichtigt, eine fast völlig durchgängigen Kanal bis zu seinem Ende zum Fortkommen auszunutzen. An mehreren Stellen stießen jedoch die Nasen der begrenzenden Schollen aneinander; die sich schnell verändernde Morphologie der dort befindlichen Pressrücken zeigte, daß die Schollen in Bewegung waren und schnell aufeinander zutrieben. Die POLARSTERN fuhr sich dann auch an einer solchen Stelle fest, und konnte erst nach mehrstündiger, Arbeit der Brücke und der Maschine aus dieser Lage befreit werden.

Auch die Wetterverhältnisse spielten eine wichtige Rolle, denn die häufigen Nebelfelder behinderten doch über längere Zeiträume die Sicht. Der Himmel war meist bedeckt, die Temperaturen um null Grad; die Niederschläge wechselten zwischen Regen, Nieselregen und Schnee, Sonnenschein hatten wir oft nur an einem Tag pro Woche. Wegen der meist großräumig bestehenden Wolkendecke waren für die von uns durchfahrene Gegend auch täglich zweimal aufgenommenen Satellitenbilder nur wenig von Nutzen. Starke Windfelder hatten in den vergangenen Tagen jedoch die Eisdecke zum Driften und Aufreißen gebracht, so daß die Weiterfahrt außerordentlich erleichtert wurde.

Die langen Distanzen zwischen den Stationen hatten jetzt dazu geführt, daß nur noch 1-2 Stationen pro Woche angelaufen werden konnten, an denen dann aber alle an Bord vertretenen wissenschaftlichen Disziplinen teilnahmen. In dieser Woche konzentrierte sich die Arbeit auf die Stationen bei $84^{\circ} 00' N 30^{\circ} 00' E$ und $85^{\circ} 05' N 29^{\circ} 15' E$. Damit waren wir an der Südflanke des Nansen-Gakkel-Rückens angelangt, auch wenn die letztgenannte Station, den Eigenschaften der Sedimente und der tischebenen Morphologie des Tiefseebodens nach zu urteilen, noch der Barents-Tiefsee-Ebene angehörten. Mit diesen Stationen war aber ein wissenschaftlich hochinteressanter ozeanographischer Schnitt in Richtung auf den Nordpol erarbeitet worden, der einen klassischen Beitrag zur Erforschung des Nordpolarmeeres darstellen wird, und der allen an Bord vertretenen meereskundlichen Disziplinen wichtige wissenschaftliche Erfolge bescherte.

Mit diesen Stationen hat die POLARSTERN Positionen erreicht, die nördlicher liegen als je von einem mobilen Forschungsschiff zuvor. Nachdem am vergangenen Wochenende der wissenschaftlichen Ergebnisse der schwedischen YMER-Expedition gedacht worden war, hat die Polarstern in der vergangenen Woche auch ihre eigene, frühere nördlichste Position übertroffen. Von den russischen Eisbrechern, driftenden Schiffen (F. Nansen's FRAM) und den inzwischen zahlreichen Eisinsel-Stationen abgesehen, war die POLARSTERN bisher am weitesten nach Norden vorgedrungen und hatte damit ihren Wert als mobile, technisch gut ausgerüstete und effektive Forschungsplattform bewiesen.

Die wissenschaftlichen Arbeitsgruppen dieser Ausfahrt hatten sich inzwischen gut aufeinander eingespielt. Um die hier an Bord vertretenen wissenschaftlichen Disziplinen gegenseitig miteinander vertraut zu machen, hatten wir die "Polar University" eröffnet, mit einführenden Übersichtsvorträgen in Methodik, Arbeitsweise und wissenschaftliche Zielsetzungen der während Arktis IV/3 an Bord der POLARSTERN versammelten meereskundlichen Disziplinen.

Der ruhige Takt der Stationsarbeiten hat jetzt Gelegenheit zu ersten wissenschaftlichen Auswertungen gegeben:

Ozeanographie (Physik, Chemie):

Die intensive Stationsarbeit entlang des Schnittes in das Barents-Tiefseebecken mit der Entnahme zahlreicher klein- und großvolumiger Wasserproben und der Messung einer Vielfalt von Parametern erlaubt erstmals die Entzifferung wichtiger Wassermassenstrukturen dieses Tiefsee-Beckens. Wasser unterhalb 3000 m im inneren Becken ist freon-frei und deutet daraufhin, daß die jüngsten Bodenwässer durch tiefe Randströme entlang des Beckenrandes geführt werden. Die Kerne von 2 solchen Randströmungen sind entlang des Kontinentalrandes durch die zahlreichen Stationen in etwa 5 km Abstand erfaßt worden; dabei reichen die Wassermassen dieser Randströme weit in das Becken hinein und erzeugen so einen komplexen Wassermassenaufbau. Neben Freon sind weitere Halocarbons gemessen worden. Alle anthropogenen Komponenten zeigen vergleichbare Tiefenverteilungen. Zusammen mit der Abwesenheit der Freone werden sie dazu benutzt werden, Verunreinigungen des Tiefenwassers (z. B. Tetrachlorkohlenstoff, Methylchloroform) zu quantifizieren.

Die wärmsten intermediären, atlantischen Wassermassen werden im Beckeninneren beobachtet, weil sie sich in der Nähe des Kontinentalrandes mit kaltem, salzarmeren Wasser mischen. Ein frontenähnlicher Wechsel einer Reihe von Wassermasseneigenschaften, der fast über die gesamte Wassersäule beobachtet werden konnte, war bei den sonst lateral weitgehend stabilen Verhältnissen sehr überraschend.

Die Probennahme für folgende wichtige Spurenstoffe war bisher sehr erfolgreich: Helium, Neon, Tritium, ¹⁴C, ³⁹Ar. An 2 Pumpenstationen sind Proben für die ¹³⁴Cs und ¹³⁷Cs Analyse des Atlantikwassers gewonnen worden.

Entlang des bisherigen Schnittes sind ebenfalls 4 Argos-Bojen der Gruppe aus Paris und eine meteorologische Boje der Hamburger Gruppe ausgesetzt worden, um Eisdrift, Ablation und Transport zu verfolgen.

Biologie:

Bei geringen Chlorophyllmengen ist die Eiproduktion calanoider Copepoden in diesen Breiten z. Zt. noch sehr schwach. Nachdem sich in den Netzfängen bisher zu 80% verschiedene Entwicklungsstadien der Copepoden befanden, wurden auf der letzten Station viele Weibchen und als neue dominante Art *Calanus glacialis* angetroffen. Mikrobiologische Untersuchungen und Probennahme der Foraminiferenmikro- und -meiofauna sind mit neuen Methoden aufgenommen worden.

Lebende planktonische Foraminiferen treten überall in den Netzfängen auf. An den ersten Stationen lag ihr Häufigkeitsmaximum unterhalb der Pyknokline. Der Anteil subpolarer Arten lag zunächst bei ca. 20 %, hat sich aber auf den letzten Stationen, an denen sie auch eine geringere Wassertiefe bevorzugen, auf ca. 1 % verringert. Bei *Neogloboquadrina pachyderma* wurden wenig stark verkrustete bzw. Kummer-Formen beobachtet. Die Pteropodenverteilung ist fleckenhaft; es treten vor allem kleine Formen auf (*Limacina* sp.) und sie sind auf die oberen 25 m der Wassersäule beschränkt.

Geowissenschaften:

Im Routinebetrieb sind mit dem SEABEAM-System und dem 3,5 kHz-Echoloty wichtige neue Daten zur Bathymetrie und zur Sedimentverteilung dieses bisher kaum bekannten Gebietes gesammelt worden. Das Seegravimeter einschließlich der digitalen Datenerfassung läuft; zusätzlich werden auch Gravimetermessungen auf dem Eis ausgeführt. Das gewonnene Kernmaterial wird routinemäßig geophysikalisch bearbeitet, um Eigenschaften der Paläomagnetik und der Wärmeleitfähigkeit zu erfassen. Es ist bisher gelungen, an 9 Stationen den Wärmestrom des Meeresbodens zu messen.

Der Zustand der Sedimentoberfläche in den Großkastengreiferproben ist hervorragend, und die mikropaläontologische/biologische Beprobung kann planmäßig durchgeführt werden. Siedlungsdichten in der Tiefsee scheinen höher als erwartet. Einige Kleinlebensräume (Oberflächen von Schwämmen) weisen extrem hohe Siedlungsdichten auf. Auf einigen GKG aus Tiefen unter 2000 m waren Chlorophyll a und Chlorophyllderivate nachzuweisen. Lebende benthische Foraminiferen sind abgesammelt und fixiert worden.

Die Beprobung der Oberflächensedimente mit den Großkastengreifern war sehr erfolgreich; der Einsatz der Entnahmeanstrumente für Sedimentkerne war jedoch wegen der sehr wechselhaften Lithostratigraphie außerordentlich schwierig. Die bräunlich bis grünlich-grauen Sedimente bestanden bisher hauptsächlich aus terrigenen, klastischen Schlämmen mit eingeschalteten Sandlagen. Anreicherungen von MnO₂-Fällungen kennzeichnen eine Reihe von Horizonten. Die Sedimente sind in einigen Abschnitten fossilführend, wobei alle wichtigen Fossilgruppen vertreten, aber in vielen Horizonten mit umgelagertem Material vermischt sind. Die Sedimentkerne dieses Schnittes enthalten bisher verblüffend wenig grobkörniges eistransportiertes Material; sie unterscheiden dadurch deutlich von den weiter westlich entnommenen Kernen der YMER-80 Expedition und den Ablagerungen in der Fram-Straße. An dem gewonnenen Probenmaterial werden ebenfalls eine Reihe physikalisch-chemischer Parameter bestimmt (in-situ Messungen; Porenwasser Auspressen).

Das Befinden des Patienten hatte sich unter Aufsicht und Obhut unseres medizinischen Personals weiter gebessert. Um für alle Eventualitäten auf der weiteren Expedition gerüstet zu sein, hatte das norwegische Rescue Center (Redningscentralen) in Bodø noch einen Versorgungsflug für Medikamente für uns organisiert. Sie wurden in 2 Sendungen am späten Vormittag des 24. Juli durch eine Orion der 333 Squadron vom Flugplatz Andøya aus in der Nähe der POLARSTERN abgeworfen und dann durch unseren eigenen Helikopter eingesammelt.

Woche 31 (27. Juli - 2. August 1987)

Die POLARSTERN befand sich am 2. August bei 85° 57.8' N 22° 25.7' E (rev. 13.30 UTC Sat Fix 85° 57.9' N 22° 26.5' E). F. Nansen's FRAM erreichte 85° 57' N, während sein Versuch, auf Skiern zum Nordpol zu wandern, bei 86° 14' N endete, weil ihm klar wurde, daß die Eisdrift ihn schneller nach Süden versetzte als er nach Norden vordringen konnte und er sich als ein langfristig planender Expeditionsführer feste Termine für seine Ziele gesetzt hatte.

Der Entschluß zum Rückmarsch fiel uns sehr schwer, da es aus wissenschaftlichen Gründen außerordentlich wünschenswert gewesen wäre, die Nordflanke des Nansen-Gakkel-Rückens zu erreichen. Wir hatten diesen Entschluß unter Berücksichtigung der langfristigen Wetterlage (Nebel!) und der herrschenden Eisverhältnisse sowie der geplanten Rückkehr nach Hamburg gefaßt. Es erschien nicht wünschenswert, die verbliebene Stationszeit durch Warten auf Wetterbesserung und günstigere Eisverhältnisse noch weiter einzuschränken. Die POLARSTERN hatte jetzt bewiesen, daß weite Vorstöße in die arktische Eisdecke möglich sind.

Das Wetter war im Großen und Ganzen gut, obwohl wir durch häufige und sich schnell verlagernde Nebelfelder sowohl in der Eisfahrt des Schiffes als auch in der Benutzung des Heli's sehr beeinträchtigt wurden. Das Eis war fast während der ganzen Woche sehr dick mit bis zu 8-10 m mächtigen Schollen, die an der Oberseite sehr stark abgetaut waren und viel Sediment trugen. Der "Schmutz" in und auf dem Eis bestand hauptsächlich aus tonigem, siltigem und z. T. sandigem Sediment und diversen biogenen Komponenten, das hier in großen Mengen durch einen bisher nicht richtig verstandenen Prozess in das Eis eingetragen wird und dann nach dem Abschmelzen auf den Meeresboden fallen kann. An größerem Material wurden bisher nur 2 Baumstämme, ein Plastikimer (engl. Aufschrift) und eine Fussmatte beobachtet. Das Fehlen von Eisbergen in diesem Gebiet erklärt vermutlich auch die Abwesenheit von grobem, eistransportiertem, terrigenem Schutt in den quartären Ablagerungen.

In der vergangenen Woche hatten wir zunächst ein vollständiges Stationsprogramm für alle Disziplinen bei 85° N abgearbeitet, und anschließend versucht, die 86° N Station zu erreichen. Die Eisverhältnisse und das Wetter verhinderten jedoch einen schnellen Fortschritt, so daß wir uns bei wechselndem, z. T. dichtem Nebel zu Stationsarbeit über dem "rift valley" des Nansen-Gakkel-Rückens entschieden, um die Schiffszeit effektiv nützen zu können. Die existierenden bathymetrischen Karten dieses Gebietes waren so ungenau, daß nach ihnen keine Stationsarbeit mehr geplant werden konnte. Die größte von uns erreichte Tiefe im zentralen Teil des Grabens betrug 5224 m. Alle Disziplinen haben die Zeit zur Probennahme genutzt und alle Versuche, Schnee-, Eis- und Wasserproben zu nehmen, waren erfolgreich. Ein halbverdautes Skelett eines Polardorsch (AHA-Erlebnis für Nico Mumm!) wurde aus einem Schmelzwassertümpel geborgen. In der Nähe der nördlichsten Position der POLARSTERN wurde ebenfalls eine ARGOS-Boje der Pariser Arbeitsgruppe ausgesetzt.

Die Wassermassen im Grabentiefsten (1.5-2 km tiefer als die benachbarten Flanken des Nansen-Gakkel-Rückens) waren gut durchlüftet; sie werden offensichtlich relativ schnell ausgetauscht, da sie etwas Freon enthielten. Die Planktonfänge waren trotz

dichter Eisdecke noch sehr reichhaltig. Oberflächensedimente aus dem "rift valley" zeigten hohen Karbonatgehalte (planktonische, benthische Foraminiferen, Coccolithen), und Spuren von chemischen Fällungen eindeutiger hydrothermalen Tätigkeit. Wärmestrom- und Schweremessungen in Abhängigkeit von der Tektonik des Ozeanbodens gelangen gut. Die geologische Probennahme gelang sehr gut mit 2 langen Sedimentkernen und einem Kastenlot. Das Kastenlot war fast leer, enthielt dafür aber stark tektonisch/hydrothermal beanspruchte basische Gesteine des vulkanischen Basement mit braunen, vermutlich hydrothermalen Krusten. Dies ist bisher die einzige ordentlich erhaltene Probe des Basement des gesamten arktischen Ozeans; eine andere ist von den Kanadiern während der CESAR-Expedition von der Flanke des Alpha-Mendeleyev-Rückens entnommen worden und besteht aus einem stark verwitterten tholeiitischen Basalt.

Woche 32 (3.-9. August 1987)

Die POLARSTERN hatte nach Erreichen ihrer nördlichsten Station ihren Rückmarsch nach Süden angetreten. Wir befanden uns am Ende der Woche 32 bei 85° 50' N 23° 09' E. Die POLARSTERN bahnte sich bei häufig dichtem Nebel und mächtigem, gepreßten Packeis langsam ihren Weg nach Süden. Rinnen erleichterten jedoch wieder das Fortkommen.

POLARSTERN's Versuch zur "Rückreise", der zu Beginn dieser Woche hatte beginnen sollen, gestaltete sich außerordentlich schwierig. Die Positionsbestimmungen der zahlreichen, z. T. jetzt von POLARSTERN ausgebrachten Driftbojen zeigten, daß das gesamte Eisfeld der östlichen Arktis eine im Uhrzeigersinn kreisende Bewegung ausführte, mit z. T. 10-15 sm nördlichem Versatz pro Tag. Gegen Ende der Woche war der Kreis vollendet und das Eis driftete nur noch langsam in östlicher Richtung. Gleichzeitig mit der nördlichen Drift verdichtete sich das Eis sehr schnell, so daß sich alle Rinnen schlossen. Da über längere Zeiträume hinweg dichter Nebel herrschte, wurde das Fortkommen des Schiffes so verlangsamt, daß es von der Eisdrift weit über die geplante nördlichste Position nach Norden getragen wurde (Fig. 4).

Wir vermuteten, daß diese Änderung der Eissituation mit einer Verschiebung der Grosswetterlage zusammenhing. Das Fahrtgebiet der POLARSTERN lag bis zum 25. Juli im Einflußbereich von Tiefdruckgebieten, die aus der atlantischen Frontalzone herauszogen und dann in zyklonalem Sinne um den Pol wanderten; dabei herrschten meist westliche Winde Stärke 3-4. Am 26. Juli zog ein kräftiges Tief von Nowaja Semlja in das Seegebiet zwischen Svalbard und der auf 85 N dampfenden POLARSTERN. Auf seiner Nordflanke stellten sich östliche Winde Stärke 4 bis 5 ein. Im weiteren Verlauf bildete sich über der Ostsibirischen See ein Hoch, das unter Verstärkung einen Keil zur Barentssee aufbaute. Am Rande dieses umfangreichen Hochs stellte sich eine beständige östliche bis südöstliche Strömung ein, die wegen der antizyklonalen Krümmung noch verstärkt wurde und im Fahrtgebiet der POLARSTERN zu SE Winden mit Stärken um 5 und entsprechender Eisdrift führte.

Die offiziellen nördlichsten Positionen waren daher zu revidieren: POLARSTERN hat am 5. 8. 87 12.00 Uhr UTC 86° 10.8' N 22° 04' E als nördlichsten Punkt dieser Reise erreicht (auf der Nordflanke des Nansen-Gakkel Rückens). Die nördlichste Stationsarbeit wurde mit Hilfe des Helikopters bei 86° 21.8' N 23° 27.3' E (Beprobung der Schnee- und Eisdecke auf Sediment) und 86° 21.8' N 23° 09.8' E (Gravimetrie) ausgeführt. Damit sind die nördlichsten Positionen der FRAM und F. Nansen's gegen unseren Willen deutlich überschritten worden. Die Eisdrift führte die POLARSTERN zunächst über das "rift valley" des Nansen-Gakkel-Rückens, das in der von uns besuchten Gegend mit über 5200 m einige hundert Meter tiefer war als auf allen verfügbaren Karten angegeben war, und das im weltweiten Vergleich eines der

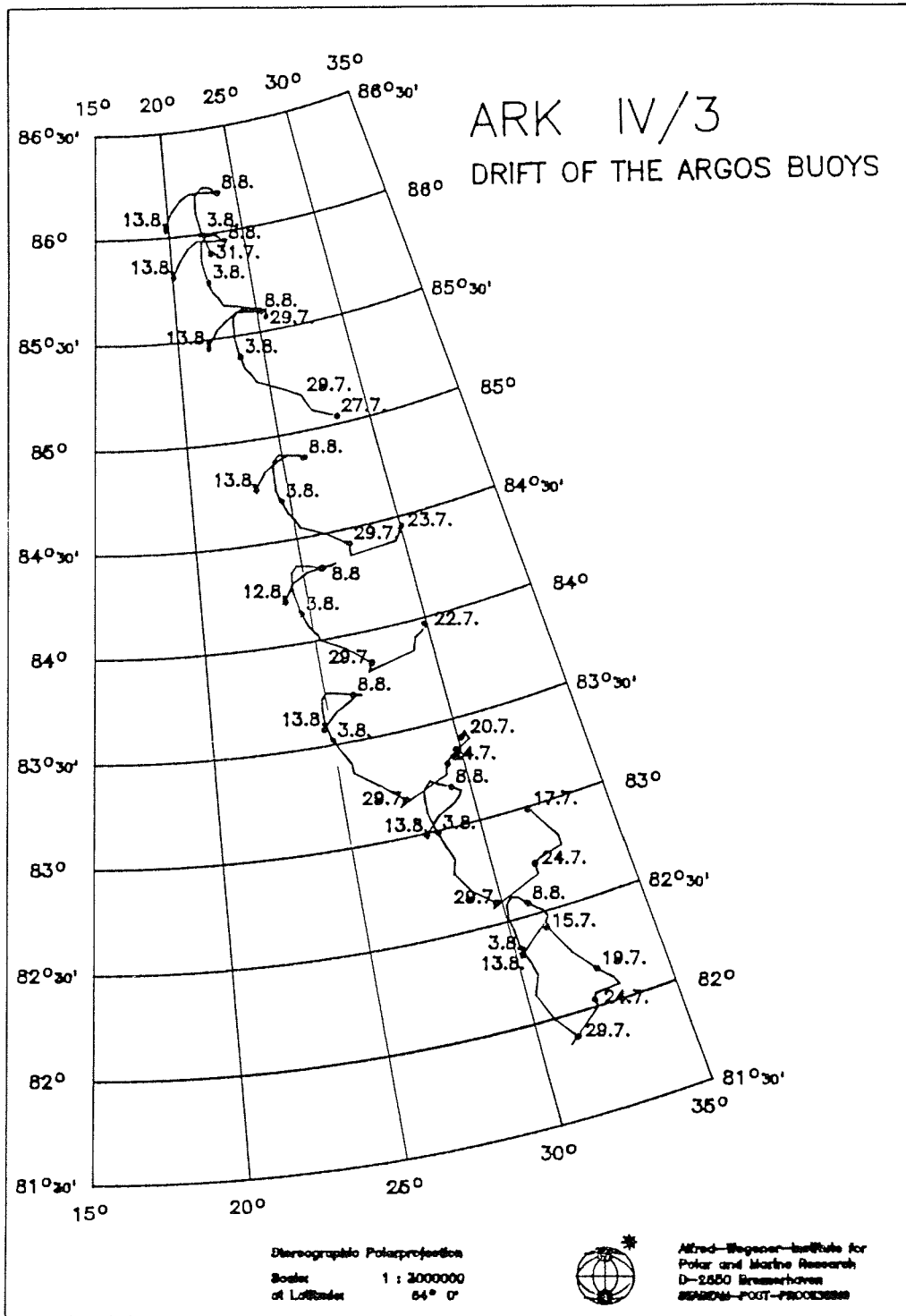

Fig.4 Drift der ARGOS-Bojen Ende Juli- Anfang August 1987, die die POLARSTERN sehr schnell nach N versetzte.

tiefsten "rift valleys" des über 60 000 km langen mittelozeanischen Rückensystems der Erde ist. Anschließend wurde die nördliche Flanke des Rückens, die der Pol (=Amundsen) Tiefsee-Ebene zugewandt ist, erreicht.

Bei Wassertiefen um 3500 m haben wir die nördlichste umfassende Station mit Beprobungen für alle an Bord vertretenen wissenschaftlichen Disziplinen abgearbeitet. Die technisch aufwendigsten Arbeiten wurden beim Ausbringen der WHOI Arctic Environmental Drifting Buoy (AEDB) ausgeführt. En route, wenn Nebel oder andere Umstände das Schiff über längere Zeit stoppten, sind zur effektiven Nutzung der Schiffszeit immer wieder Einzelinstrumente gefahren worden.

Hohe Sedimentationsraten und der schnelle Eintrag klastischen terrigenen Materials scheinen durch den Nansen-Gakkel-Rücken nicht behindert zu sein. Die Sedimentkerne waren weiterhin durch eine Wechsellagerung von glazialen und interglazialen Ablagerungen geprägt. Schwere- und Wärmestrom-Messungen sowie Wärmeleitfähigkeitsschnitte in Sedimenten wurden über das gesamte abgefahrene Profil vervollständigt. Neben den inzwischen erwarteten tiefen und sehr schmalen Randströmen zeigten sich am Südhang des Nansen-Gakkel-Rückens deutliche Hinweise von Überströmungsvorgängen von Wassermassen aus dem weiter nördlich liegenden Amundsen-Becken. Im "rift valley" des Rückens deuteten sich Wassermassen aus der Fram-Straße und damit aus dem weiter südlich gelegenen Europäischen Nordmeer an. Planktonfänge waren erstaunlicherweise weiterhin ergiebig, aber jetzt durch hocharktische Lebensgemeinschaften gekennzeichnet. Die Eisoberflächen und -mächtigkeiten waren dabei sehr veränderlich, über große Gebiete hinweg durch hohe Sedimentkonzentrationen geprägt und deutlich braun gefärbt. Alle Verfärbungen des Eises, mit Ausnahme von sehr unregelmäßig verteilten Algenbewuchs auf seiner Unterseite, gehen auf Verunreinigungen durch tonig-siltiges Sediment zurück, in denen keine biogenen Komponenten zu beobachten waren; diese Sedimentmengen müssen einen hohen Anteil der rezenten Sedimentzufuhr in die arktischen Tiefsee-Ebenen ausmachen.

Das Erreichen der nördlichsten Station (Fig. 5) und der bedeutenden nautischen, technischen, und wissenschaftlichen Ziele dieser Expedition wurden während laufender Stationsarbeit durch die Freigabe des Eises für alle abkömmlichen Teilnehmer dieser POLARSTERN-Ausfahrt markiert. Die weiblichen Teilnehmer der Ausfahrt haben den Beitrag der Frauen zur Arktis-Forschung am Sonntagmorgen mit einem bescheidenen Empfang gefeiert (Fig. 6). Gruppenphoto und Fahnen aller teilnehmenden Nationen an der Schiffsseite schufen eine bleibende Erinnerung (Fig. 7).

Woche 33 (10.-16. August 1987)

POLARSTERN hatte nach schwerer, dann zunehmend leichter werdender Eisfahrt in dieser Woche das Gebiet des Yermak Plateaus nördlich Svalbards erreicht. Nach Erledigung der hier geplanten Stationsarbeiten liefen wir an Svalbard vorbei in die Fram-Straße und versuchen, nach Erreichen des Grönlandschelfes bei 79° N zunächst die beiden im Frühsommer dieses Jahres von mächtigem Eis bedeckten Verankerungen von Meincke (Hamburg) zu bergen. Weitere Stationsarbeit und die Fortsetzung der SEABEAM Surveys waren dann im Gebiet der zentralen Fram-Straße vorgesehen.

Die nördliche Drift, die das Packeisfeld über der Barents-Tiefsee-Ebene und zeitweise die POLARSTERN weit nach Norden trug, abgeschlossen hatte, ging anschließend zunächst in eine langsame östliche und dann südliche Bewegung über, wobei gleichzeitig die Pressung des Eises nachließ. Zu Beginn dieser Woche bestimmte zunächst die Warmfrontwelle eines Tiefs beim Nordkap das Windfeld mit S-, SW- und NW-Winden Stärke 4. Im weiteren Verlauf weitete sich ein Hoch über Grönland ostwärts aus, so daß wir an seiner Ostflanke in eine nördliche Strömung gerieten. Während des gesamten Zeitraumes herrschte eine hohe mittlere Bedeckung, und es kam häufig zu

***** INDAS V SATELLITE FIX RESULTS AND UPDATES

FIX 2D WGS 72

LAT N 86 10.882
LON E 22 4.094
UTC 13 38 00 05-AUG-87
SLT 140 SLN 111
EL IT CT DIST DIR SAT R
73 3 39 0.13 076 300 1
GEOM SE



TIME	SYS.-LAT	SYS.-LON	MODE	SP F/A	GYRO	ECHOSOUND	PRSS	AIRTMP S/P	WATRMP S/P	WDIR S/P	WINDVEL S/P
14:00:00	N 086 09.56	E 022 01.67	IDS	M 000.5	198.3	6991.0	H 1027	-00.2/ 00.1	-00.9/-00.6	191/ 196	05.6/ 05.9
14:10:00	N 086 09.48	E 022 01.36	IDS	M 000.5	196.9	7314.0	H 1027	-00.2/ 00.1	-00.9/-00.6	191/ 195	07.0/ 07.1
14:20:00	N 086 09.40	E 022 01.09	IDS	M 000.5	193.6	4561.0	H 1027	-00.3/ 00.0	-00.9/-00.6	187/ 191	06.8/ 07.2
14:30:00	N 086 09.32	E 022 00.86	IDS	M 000.5	183.8	5946.0	H 1027	-00.2/ 00.1	-00.9/-00.6	186/ 190	07.3/ 07.7



MS/TS FS „Polarstern“ Datum: 5.8.1987
 Breite 86° 11' N Distanz: 4
 Länge 22° 04' E Durchschnittl. Fahrt: 0.11
 Die Uhr wird am Laufe der Nacht — Minuten — vorausgesetzt
 Tonight ship's clocks will be — minutes — advanced
A. Wegener
 121-Nachrichtentechnik 411132-104-100-1281-018

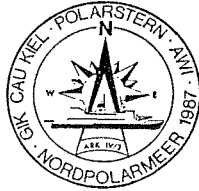

Fig.5 Positionsprotokoll PFVS POLARSTERN nördlichste Position
86° 11' N 22° 04' E am 5. August 1987.



GEDENKFEIER AUGUST 9, 1987

In the past, only a few women have been included in scientific parties on the Arctic Ocean ice. The courage and determination of these women are, in a way, "ice breakers" for women who today venture into Arctic research. We take great pride in being participants on this epic voyage of the "POLARSTERN" which includes, we think, the largest group of women as yet to take part in a scientific expedition into the Arctic Ocean.

Today we wish to salute all the women who have, are, and will in the future take part in Arctic Ocean exploration.

Heute möchten wir an alle Frauen denken, die in der Vergangenheit, in der Gegenwart und in Zukunft an der Erschließung der unbekanntenen Arktis teilnehmen.

14 Signatures:

<p> <i>Monika E. Sobiesiak</i> <i>Roswitha Lübbe</i> <i>Jabine Horwege</i> <i>Ilse König</i> <i>Elisabeth Riebig</i> <i>Bettina J. Müller</i> <i>Ulrich Hoppe</i> </p>	<p> <i>Michaela Kulbick</i> <i>Ulrich Feigl</i> <i>Kerstin Baumann</i> <i>Sybilie Hummel</i> <i>Anna Hilg</i> <i>Ulrich Hilg</i> <i>Robert Thonhausen</i> </p>
--	--

Fig. 6 Tag der "Frauen in der Arktis-Forschung", 9. August 1987.

Sichtbehinderungen durch Dunst- und Nebelfelder, zeitweise auch zu leichtem Schneefall. Nachdem die Gebiete alten und mächtigen Eises im Norden verlassen worden waren, wurden die Eisverhältnisse in den Gebieten, die die POLARSTERN in dieser Woche durchfuhr, im Verlaufe dieser Wetterentwicklung zunehmend leichter, so daß die durch das schwere Eis im Norden verursachten Verspätungen im Expeditionsablauf wieder aufgeholt worden sind

Auf südlichen Kursen durchkreuzte die POLARSTERN auf dem Wege vom Nansen-Gakkel-Rücken das Gebiet der Barents-Tiefsee-Ebene. Da zunächst hauptsächlich Breite gut zu machen war, konzentrierte sich die Stationsarbeit im Wesentlichen auf 4 Positionen, in denen alle an Bord vertretenen Disziplinen umfangreiche Meß- und Beprobungsprogramme abarbeiteten, nämlich

85° 23' N 21° 55' E;
83° 24' N 19° 58' E;
82° 51' N 17° 15' E (nur Ozeanogr, wegen Wassertiefe),
82° 48' N 16° 04' E (nur Geow. auf dem östlichen Ausläufer des Yermak Plateaus);
82° 02' N 15° 23' E.

Das "typische Menu" großer Stationen sah als wie bisher folgendermaßen aus: CTD, Multinetz, Bongo, Biorosette, Multinetz, Large Volume Sampler, Heavy Metal Sampler, 2 Großkastengreifer, Kastenlot, Wärmestromlanze, Schwere-/Kolbenlot.

Auf den Stationen und en route wurden das Eis beprobt, Drift-Bojen der Gruppen Paris/ Hamburg ausgesetzt, Gravimetrie durchgeführt, zahlreiche Schnee- und Wasserproben entnommen, die Fischereiversuche fortgesetzt und in regelmäßigen Abständen XBT's und XCP's gefahren. An Bord waren jetzt in großem Umfang Analysenprogramme zur genauen Beschreibung des gesammelten Probenmaterials angelaufen.

Zur Zeit vorliegende vorläufige Ergebnisse umfassen u. a.:

Eisuntersuchungen:

Zwischen 81° 29' N und 86° 07' N wurden an 28 Stationspunkten 67 Eiskerne mit einer Gesamtlänge von 154 m erbohrt. Davon enthielten 27 Eiskerne deutlich sichtbare Fremdmaterialeinschlüsse. Gleichzeitig wurden 40 Proben der Schneeoberfläche entnommen.

Drift-Bojen:

In der letzten Woche wurden die letzten der 11 ARGOS-Bojen von POLARSTERN ausgesetzt. Aus der Drift der Bojen, die in ca. 10 Monaten die Fram-Straße nach Süden verlassen und nach weiteren 2-3 Monaten bis auf die Höhe von Jan Mayen treiben, und dem Temperaturprofil im Eis wurden wichtige Aussagen über Transport von Eis, Süßwasser und Wärmehaushalt in der ozeanischen Deckschicht berechnet.

Ozeanographie:

Das ozeanographische Meßprogramm konzentrierte sich auf einen Schnitt aus dem Nansen-Becken über das Yermak-Plateau auf Spitzbergen zu. Dort sollte die Wiederholung einer Station vom Juli 1984 mit relativ hohen Freon-Konzentrationen klären, ob die sehr geringen Konzentrationen in mittleren und großen Tiefen auf unserem Schnitt nach Norden zu Anfang von ARK IV/3 eine grundsätzliche Veränderung der Tiefenzirkulation seit 1984 bedeuten oder ob diese Unterschiede nur der Ausdruck von inhomogenen tiefen Wassermassen sind.

Phytoplanktologie:



1.Stute	2.Guo	3.Vassmyr	4.Geiger	5.Müller	6.Richter
7.Masten	8.Anderson	9.Jones	10.Lundström	11.Feigler	
12.Bieser	13.Kromer	14.Mudie	15.Schlosser	16.Weber	
17.Nowaczyk	18.Klauck	19.Bönisch	20.Zemlyak	21.Rodriguez	
22.Koltermann	23.Wallace	24.Botz	25.Pagels	26.Marian	
27.Oelkers	28.Jonas	29.Kubisch	30.Götting	31.Matthiessen	
32.Lüthje	33.Müller	34.Wollenburg	35.Torp	36.Körner	
37.Krishfield	38.Gascard	39.Bleil	40.Heine	41.Richez	
42.Haake	43.Horwege	44.Allers	45.Mahler	46.Schlüter	
47.Sonnabend	48.Muus	49.Thiede	50.Sobiesiak	51.Carstens	
52.Westerlund	53.Osborne	54.Baumann	55.Spielhagen	56.Fritz	
57.Hirschberg	58.Buesseler	59.Swift	60.Mckeown	61.Pfirman	
62.Krysell	63.Altenbach	64.Bohrmann			

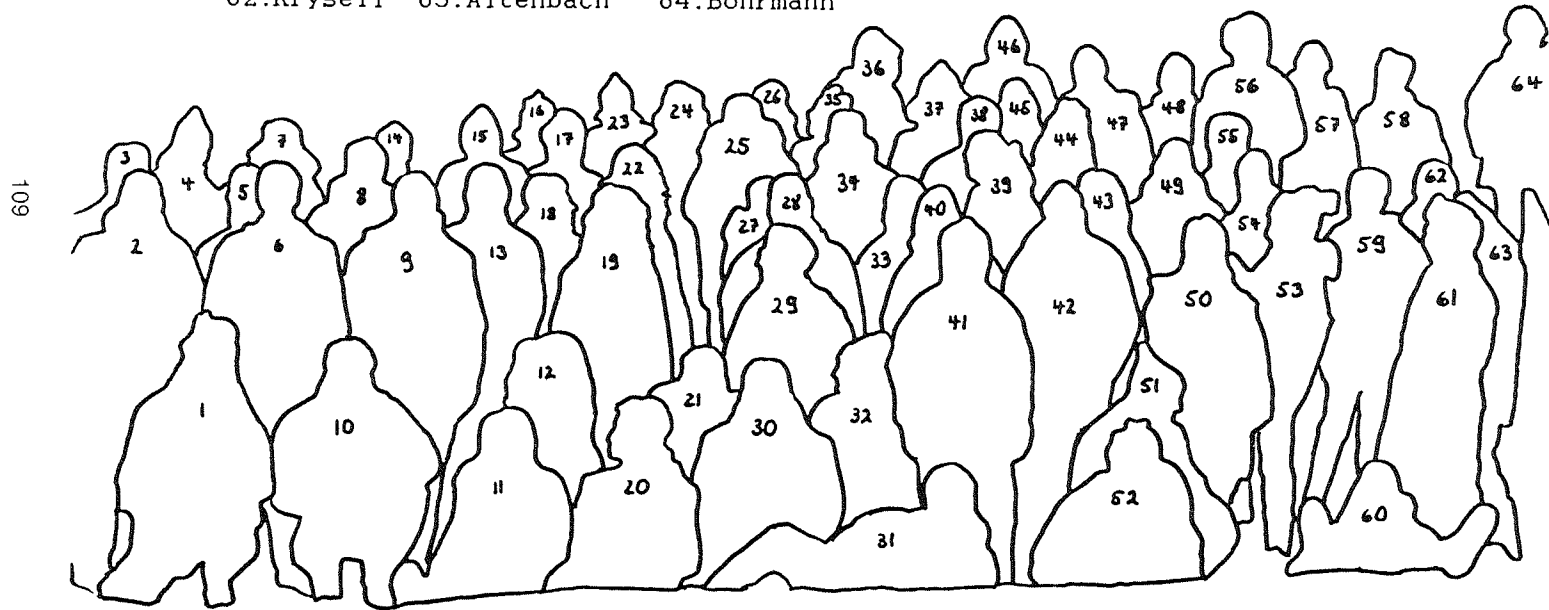

Fig.7 Gruppenbild der Besatzung und wissenschaftlichen Expeditionsteilnehmer beim Eisgang nach Abschluß der nördlichsten Station.

Bei einer Eisbedeckung von von 8/10-9/10 konnte sich im Bereich von Station 11/393 eine kleine Phytoplanktonblüte entwickeln, vorwiegend aus *Chaetoceros socialis* und anderen *Chaetoceros*-Arten bestehend. Diese Arten fanden sich vereinzelt auch an den vorangegangenen Stationen, doch war die gesamte Phytoplanktondichte stets so gering, daß die Primärproduktion kaum meßbar war.

Zooplanktologie:

Nachdem sich POLARSTERN während der letzten Wochen in faunistisch rein arktischen Gewässern mit an geringe Primärproduktion angepaßten Arten wie *C. glacialis*, *C. hyperborea*, *M. longa* aufgehalten hat, überquerte sie in dieser Woche erneut die Faunengrenze bei 84° N und befand sich nun wieder in Meeresgebieten, die durch das massenhafte Auftreten von Copepodit-Stadien sowie dem erneuten Vorkommen von *C. finmarchicus* gekennzeichnet waren. In den Multinetzfängen fanden sich auch weiterhin planktische Foraminiferen, während die Pteropoden zahlenmäßig abgenommen hatten. Die Faunengrenze bei ca. 83° N bestätigte sich auch auf Südkurs. Auffallend war immer wieder das kräftig rote bis braunrote Plasma bei den planktischen Foraminiferen.

Makrobenthos:

Bei durchgehend geringen Siedlungsdichten wurden folgende Makro-Invertebraten von den Sedimentoberflächen der Kastengreifer geborgen:

Kontinentalhang: Polychaeten, Crustaceen, 1 Panthropode, 1 Crinoide, 1 Porifere.
Nansen Becken: 1 Seegurke (*Elpidia glacialis*), 1 Hydrozoe, 1 Porifere.
Nansen-Gakkel-Ridge: Lammellibranchiatenklappen, Gastropodengehäuse, wenige Polychaeten. Teilweise reiches Mikro-Epizoon, Methanol/Bengalrosa-Konservierung.

Geowissenschaften:

Die 3.5 kHz-Schriebe spiegelten deutlich die Abhängigkeit der Sedimentverteilungen von der tektonischen Struktur des Untergrundes wieder. Besonders eindrucksvoll war die tischebene Barents Tiefsee-Ebene, während die terrassenförmigen Teile des Nansen-Gakkel-Rückens und des Yermak-Plateaus deutlich von einem pelagischen Sedimenttyp bedeckt waren. Wärmeleitfähigkeit und magnetische Suszeptibilität der Sedimente waren deutlich lithologieabhängig. Kurze und längere (maximal wenige hunderttausend Jahre alt) Sedimentkerne spiegelten den Wechsel zwischen eiszeitlichen und zwischeneiszeitlichen Sedimenten wieder. In der Sedimentzusammensetzung bildete sich erstaunlicherweise eine deutliche Regionalität der Ablagerungsbedingungen ab.

Woche 34 (17.-23. August 1987)

Die POLARSTERN befand sich zu Ende dieser Woche in der zentralen Fram-Straße, wo bei strahlendem Sonnenschein und beinahe windstillen Verhältnissen ideale Bedingungen für die auszuführenden SEABEAM-Arbeiten herrschten. Leider hatte sich durch die NW-lichen Winde die Eisgrenze so weit nach SE verschoben, daß die sinnvollerweise zu vermessenden Gebiete erst gefunden wurden, nachdem wir dem Eisrand bis auf 78° 48' N 2° 09' E gefolgt waren. Am Sonnabend Abend sahen wir in der Nähe der Eisgrenze mehrere Schulen blasender Wale. In der kommenden Woche sollte noch eine umfassende Station in der zentralen Fram-Straße abgearbeitet werden und die noch verbleibende Schiffszeit zur Weiterführung der SEABEAM-Vermessung genutzt werden, bis die POLARSTERN gegen Ende der Woche die Heimreise antreten mußte, um zu dem vorgegebenen Termin in Hamburg einlaufen zu können.

Das Fahrtgebiet der POLARSTERN befand sich in dieser Woche nördlich eines Tiefs, das aus dem Raum Nowaja Semlja nach Svalbard gezogen war. Bei vorherrschend nördlichen Winden Stärke 3-4 kam es im Bereich der okkludierten Front zeitweise zu leichten Schneefällen. Dieses Tief regenerierte sich durch Kaltluftzufuhr aus dem Norden und entwickelte sich damit auch in der Höhe, wodurch es bis zum 21. August stationär wurde. Durch einen von Grönland nachfolgenden Hochkeil verschärfte sich der Druckgradient im Fahrtgebiet, so daß der Wind vorübergehend Stärke 5-6 erreichte. Durch Auffüllung und gleichzeitige Ostverlagerung wurde am 22. August Hochdruckeinfluß von Grönland her mit schwachen nordwestlichen Winden wetterwirksam.

Anfang dieser Woche hatten wir den südlichen Teil des Nansen-Beckens über dem Yermak-Plateau und die Eisgrenze gegen die wärmeren atlantischen Wassermassen erreicht und erledigten die letzten Stationsarbeiten im eigentlichen Nordpolarmeer. Die Eisbedeckung des südlichen Nansen-Beckens war wesentlich leichter zu bewältigen als erwartet (von wenigen großen Schollen abgesehen, die aber nur im Nebel Schwierigkeiten bereiteten). In der Nähe der Eisgrenze fand ein historisches Treffen zwischen der EUROPA und der POLARSTERN statt.

Nach Passieren NW Svalbards und der Ufer des Magdalenenfjordes, eines der großen alten Walfangzentren Svalbards, kreuzten wir die Fram-Straße, um die Positionen von 2 Hamburger ozeanographischen Verankerungen bei 79° N auf dem ostgrönländischen Schelf zu erreichen, die aufgenommen werden sollten. Die Eisgrenze des Ostgrönlandstromes wurde bereits früher als erwartet bei 79° N 2° E angetroffen; die Eisverhältnisse stellten sich danach zunehmend schwieriger dar, weil mehrere Zonen großer, mächtiger und offensichtlich sehr alter Eisschollen umfahren werden mußten. Es war sehr schnell klar, daß die westliche Verankerung bei 79° N 13° W nur unter großem zeitlichem Aufwand erreichbar war und daß die verfügbaren Satellitenbilder eine geschlossene Eisdecke in der Umgebung der angegebenen Position vermuten ließen; es wurde daher kein Versuch unternommen, diese Position anzulaufen. Bei Erreichen der östlichen Verankerungsposition stellte sich ebenfalls heraus, daß sie von einer großen Scholle in dichtem Packeis bedeckt war und daher zunächst für uns unerreichbar war. Die 0.3 kn schnelle SW-liche Drift des Ostgrönlandstromes ausnutzend, dredgten wir trotzdem zweimal über die angegebenen Position; leider konnte die Verankerung nicht gefunden werden (Fig. 8). Da die Eisverhältnisse sich zunehmend verschlechterten und wir nicht noch mehr Zeit für dieses ungewisse Vorhaben aufwenden wollten, entschlossen wir uns zur Rückkehr in den östlichen Teil der Fram-Straße.

Nach schwieriger Eisfahrt in z. T. dichtem Nebel erreichten wir wieder die nun durch NW-liche Winde deutlich aufgelockerte Eisgrenze. Da wir Ersatzteile nach Longyearbyen bestellt hatten, steuerten wir zunächst die Mündung des Isfjord an. Die bestellte Fracht wurde mit dem Helikopter vom Flughafen Longyearbyen abgeholt, der Besuch dort zu einer Eichungsmessung für das transportable Gravimeter ausgenutzt, und es gelang, mit 2 auf Svalbard kartierenden Geologie-Studenten der Universität Kiel Kontakt aufzunehmen. Danach wurde Kurs auf das Gebiet genommen, das mit SEABEAM, 3,5 kHz und Seegravimeter vermessen werden sollte.

Die meisten Gruppen hatten in dieser Zeit ihre Stationsarbeit nahezu abgeschlossen und waren dabei, die aufregenden Meß- und Sammlungsergebnisse für den Fahrtbericht aufzuarbeiten. Es bestand eine sehr gute Übereinstimmung der Grenze zwischen den Atlantischen und Arktischen Wassermassen bei 83° N (man merke: weit unter dem Packeis) und dem Vorkommen planktischer und benthischer Fauna. An der Station im Sofia-Tief nördlich Svalbards wurden die hohen Freonwerte der Messungen im Jahre 1984 bestätigt; das Gebiet unterlag also auch in 2200 m Tiefe einem viel stärkeren Einfluß vom Schelf, dabei besonders von der Hinlopen-Straße her. Dieses bedeutet auch, daß alle Stationen in diesem Gebiet, die bisher als "beispielhaft für den

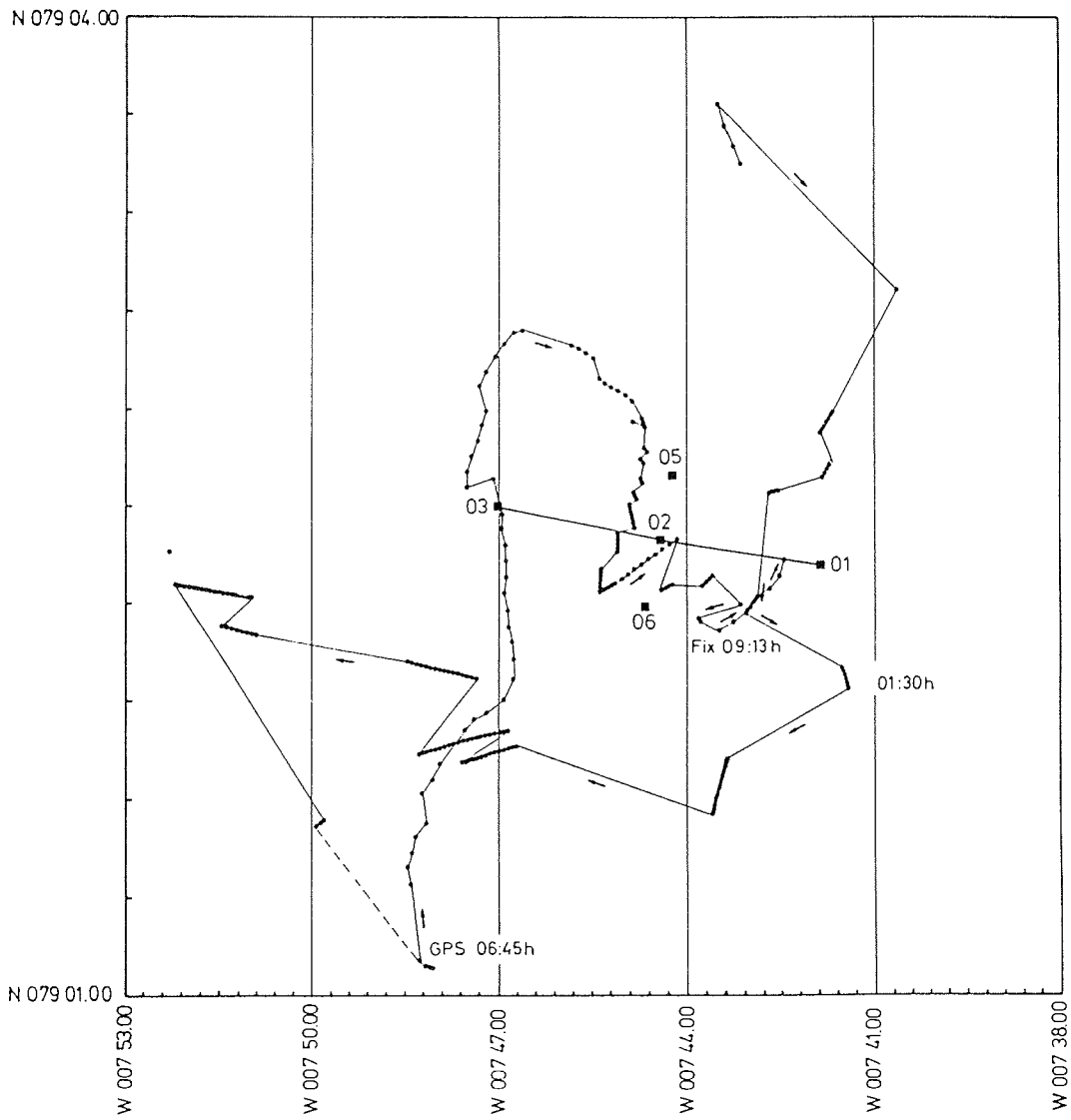

Fig.8 Versuche der POLARSTERN, in dichtem Eis eine Ver-
 ankerung auf dem Oströnlandschelf zu bergen. Bemerkte

südlichen Arktischen Ozean" angesehen wurden, nur kleinräumige ozeanographische Eigenschaften dieses Teilgebietes des Nordpolarmeeres erfaßten.

Die Sedimentkerne waren durch eine deutliche "glaziale" und "interglaziale" Schichtung gekennzeichnet; ihre anscheinend sehr hohen Sedimentationsraten und die vorgefundenen, stark klastisch beeinflussten Sedimentfazie unterschieden sich deutlich von den pelagischen Ablagerungen der zentralen Arktis. Auffallend waren schichtenweise Konzentrationen von Kohlebruchstücken und das häufige Vorkommen diskusförmiger, mm-großer, hohler, bernsteinähnlicher organischer Komponenten unbekannter Herkunft. Die Sedimente scheinen regional ebenfalls hohe Anteile vulkanischer Komponenten zu enthalten.

Woche 35 (23.-30 August 1987)

Das Wetter war in dieser Woche ideal für die Durchführung der SEABEAM-Vermessung in der Fram-Straße. Windstille und Perioden von Wind bis zu Stärke 4 lösten einander ab, die Sicht war überwiegend gut. Perioden sonnigen Wetters wechselten mit überwiegend bedeckten und nebligen Wetterlagen, die aber für die auszuführenden Arbeiten kein Hindernis bedeuteten. Durch die Drift der Eisfelder im Westen des Untersuchungsgebietes und die überwiegend NW-, W- und SW-lichen Winde verschob sich die SE-liche Begrenzung der Eisbedeckung zu unseren Ungunsten immer weiter nach SE, wodurch die eigentlichen Vermessungsarbeiten aber nur geringfügig behindert wurden, weil der Eisrand sehr aufgelockert war.

In dieser Woche waren noch 2 wichtige wissenschaftliche Aufgaben zu erledigen, nämlich eine Fortsetzung der SEABEAM-Vermessungsarbeiten in der zentralen Fram-Straße und eine Station zwischen Hovgaard und Molloy Fracture Zone. Das Untersuchungsgebiet dieser Woche lag vorwiegend in der Nähe der SE-lichen Packeisgrenze, die durch für arktische Verhältnisse besonders reiche Faunen gekennzeichnet war. Neben wiederholt gesichteten Walen waren besonders die großen Herden (oft bis 100 Tiere) von Seehunden auffallend. Am Rande von Eisschollen wurde immer wieder Fisch gesichtet, der Seevögeln als Nahrung diente. Gleichzeitig wurde die vorläufige Auswertung der im Nordpolarmeer gewonnenen Daten und Proben fortgesetzt und erste Ergebnisse für den Fahrtbericht zusammengestellt.

Das Gebiet der SEABEAM-Vermessung war erst erreicht worden, nachdem wir dem Eisrand in SW-licher Richtung bis auf 78° 48' N gefolgt waren. Die Eislage dieses Jahres verhinderte, daß wir die zunächst gewünschten Untersuchungsgebiete im NW und W des Molloy-Tiefs vermessen konnten und zwang uns, das Seegebiet im südlichen Anschluß an das Meßgebiet von ARK IV/1 aufzusuchen. In der verfügbaren Zeit wurde das Koordinatenfeld 78° 48' N bis 78° 27' N und 2° 10' E bis 5° 30' E vermessen. Vor Antritt der Heimreise wurde das Gebiet noch von seiner südöstlichen Ecke her zweimal diagonal durchlaufen. SEABEAM- und 3,5 kHz Daten waren von ausgezeichneter Qualität. Gleichzeitig nahm das an Bord befindliche Seegravimeter das Schwerfeld im Meßgebiet auf. Das untersuchte Gebiet lag in einem morphologisch ausgeglichenem Gebiet, in dem ein welliger tieferer Untergrund von einer auffallend regelmäßigen Decke pelagischer, deutlich geschichteter Sedimente verhüllt wurde. In einigen Gebieten wurden Sedimentwellen und bis an die Oberfläche durchschlagende Verwerfungen beobachtet.

Abschließende Stationsarbeiten waren für die Position 78° 48' N 1° 40' E geplant und die POLARSTERN mußte nach 2 Tagen SEABEAM-Vermessung auf dem Wege zu dieser Station noch einmal in relativ dichtes Packeis zurückkehren. Die Station gab uns Gelegenheit für den Einsatz einer Reihe von Instrumenten zur Beprobung der

Wassersäule und des Meeresbodens. Trotz des Einsatzes diverser Instrumente entzog sich jedoch auch an dieser Station der Polardorsch unseren Fangversuchen. Neben CTD, Bongo und Wasserschöpfern zur Probennahme für Spurenmetalle wurden vor allem stratigraphisch außerordentlich wertvolle Sedimentkerne gewonnen, die deutlich die glazial-interglazialen Sedimentwechsel widerspiegeln. Die erreichte maximale Kernlänge betrug 8,13 m, das stratigraphische Alter beträgt maximal um 175000 Jahre. Damit hatten alle auf dieser Expedition gewonnenen Kerne nur relativ junge Alter erbracht, was auf einen sehr hohen Sedimenteintrag während des im östlichen Nordpolarmeere während des jüngeren Quartärs schließen läßt. Besonders auffallend waren schichtgebundene Anreicherungen groben eistransportierten terrigenen Detritus, die wir in ähnlichen Sedimenten des zentralen Nordpolarmeeres vermißt hatten. Damit konnte das östliche Tiefseebecken des Nordpolarmeeres deutlich als eine eigene Sedimentprovinz vom zentralen Nordpolarmeere und von den Gebieten in unmittelbarer Nähe der Fram-Straße abgetrennt werden.

Donnerstag, den 27. August brach POLARSTERN die SEABEAM-Vermessung in der zentralen Fram-Straße ab und trat die Heimreise nach Deutschland an; vorausgesetzt, daß kein schlechtes Wetter zu Verzögerungen führte, war die Ankunft der POLARSTERN für den 2. September um 22.30 Uhr bei der Werft Blohm & Voss in Hamburg geplant, wo sie sofort im Schwimmdock 11 eingedockt werden sollte.

Woche 36 (30. August - 3. September 1987)

POLARSTERN fuhr zu Anfang dieser Woche an Südnorwegen vorbei und nahm in der nördlichen Nordsee dann Kurs auf Hamburg, wo sich die wissenschaftlichen Expeditionsteilnehmer am 3. September ausschiffen sollten, um an ihre Heimatinstitutionen zurückzukehren.

Das Programm der POLAR UNIVERSITY fand seinen Abschluß in einer gemeinsamen Sitzung von Besatzung und wissenschaftlichen Fahrtteilnehmern, auf der die wichtigsten Erkenntnisse dieser aufwendigen Expedition in Kurzvorträgen dargestellt wurden. Die technische Leistungsfähigkeit der POLARSTERN, ihre guten Eigenschaften als Forschungseisbrecher, und vor allem die wissenschaftlich sehr produktive, angenehme und nahe Zusammenarbeit zwischen den Damen und Herren der Besatzung und der wissenschaftlichen Fahrtteilnehmer wurde bei allen Gesprächen und Vorträgen immer wieder deutlich betont. Man war sich des Privilegs, an dieser aufwendigen Expedition, für die das Alfred-Wegener-Institut auf das großzügigste Schiffzeit der POLARSTERN zur Verfügung gestellt hatte, teilnehmen zu dürfen, sehr wohl bewußt. Alle Teilnehmer waren froh, daß das Schiff ohne wesentliche erkennbare Schäden nach dieser schwierigen, aber wissenschaftlich so ergiebigen Expedition in die zentrale östliche Arktis nach Deutschland zurückkehrt.

Die neu gewonnenen wissenschaftlichen Daten über die natürlichen Eigenschaften des zentralen südlichen Teils des eurasischen Beckens des Nordpolarmeeres bedeuten einen großen Fortschritt in der Kenntnis des Nordpolarmeeres und im Verständnis der meteorologischen, ozeanographischen, biologischen und geologischen Prozesse, die die besonderen Eigenschaften dieses polaren Ozeans prägen. Viele Aspekte dieser Eigenschaften lassen sich aber nicht ohne weitere zusätzliche Beobachtungen aus den bisher nicht untersuchten Teilbecken des Nordpolarmeeres, insbesondere dem Amundsen-Becken auf der eurasischen Seite und dem Makarov-Becken auf der amerasischen Seite des Lomonosov-Rückens verstehen. Viele der Teilnehmer der Expedition ARK IV/3 sind sich daher in dem Wunsch einig, in einigen Jahren zu einer neuen interdisziplinären Expedition in das zentrale Nordpolarmeere aufzubrechen. Als dafür geeignete Jahre wurden 1991 oder 1992 angesehen. Das Ziel der Expedition (TRAPOLEX) wäre, die POLARSTERN vom Laptev-Schelf der transpolaren Eisdrift folgen zu lassen und dabei zu versuchen, das Amundsen-Becken und den Lomonosov-

Rücken auf dem Wege zum Makarov-Becken zu queren und dann auf dem Wege über den Nordpol, das Seegebiet nahe Svalbard, in das Europäische Nordmeer zurückzukehren. Die POLARSTERN könnte dabei auch einen wichtigen Beitrag zur Vorbereitung arktischer Tiefesebohrungen leisten.

Man war sich uns darüber im Klaren, daß diese Expedition nur im internationalen und interdisziplinären Verbunde durchzuführen ist, daß der Plan von beträchtlichen politischen Unsicherheiten geprägt ist, daß die POLARSTERN für ein langes zusammenhängendes Zeitintervall zur Verfügung stehen muß und die Teilnehmer u. U. per Flugzeug ausgetauscht werden müssen, und daß die POLARSTERN u. U. zusätzlicher Eisbrecher-Unterstützung bedarf. Nach den positiven Eindrücken von ARK IV/3 scheint der Expeditionsplan ausführbar.

3.3. DANKSAGUNG

Die Expedition ARK IV/3, die die POLARSTERN im Jahre 1987 in den zentralen Teil des östlichen arktischen Ozeans führte, die am 4. Juli in Tromsø (Norwegen) begann und am 2. September in Hamburg endete, hat ein bisher nahezu unbekanntes Meeresgebiet aufgesucht und wichtige, neue wissenschaftliche Erkenntnisse gewonnen.

Die wissenschaftlichen Arbeitsgruppen, die den Vorzug hatten, an dieser Ausfahrt in das zentrale östliche Nordpolarmeer teilzunehmen, sind vielen Personen und Institutionen zu großem Dank verpflichtet.

Das Alfred-Wegener-Institut für Polar- und Meeresforschung (AWI) in Bremerhaven, vertreten durch seinen Direktor, Herrn Prof. Dr. G. Hempel, hat in großzügigster Weise Schiffszeit auf der POLARSTERN zu Verfügung gestellt und dieses vorzügliche Schiff für die Expedition bereitgestellt. Herr Prof. Dr. E. Augstein vom AWI hatte die Koordination dieser Expedition übernommen. Herr Prof. Dr. D. Fütterer und Herr Dr. H. Kohnen sowie seine Mitarbeiter in der AWI-Logistik haben uns in der Lösung vieler schwieriger Probleme beratend und helfend zur Seite gestanden.

Die Besatzung der POLARSTERN unter ihrem Kapitän H. Jonas von der HAPAG-LLOYD T&S haben auf vorzüglichste Weise mit den in- und ausländischen wissenschaftlichen Fahrtteilnehmern zusammengearbeitet und die Lösung vieler komplexer Forschungsaufgaben durch ihren Einsatz erst möglich gemacht. Zur Durchführung dieser schwierigen Expedition in die von mächtigem Packeis bedeckte zentrale östliche Arktis gehörten Erfahrung, Ausdauer und großes nautisches Können. In vielen technischen Fragen wurde uns von Lt. Ing. K. Müller und seinen Mitarbeitern geholfen.

Durch einen schweren Krankheitsfall während der Expedition wurde das Hospital unter der kundigen Leitung von Dr. Heine und der Pflege der Krankenschwester, Frau Liboner, über Gebühr beansprucht. Fernaufklärer der Squadron 333 von der Andøya flyst, der königlich norwegischen Streitkräfte warfen zweimal auf unsere dringende Bitte hin Medikamente über dem Eis in der Nähe der POLARSTERN ab, von wo sie durch den mitgeführten Helikopter geborgen wurden. Der Patient verläßt die POLARSTERN geheilt. Das AWI und die Christian-Albrechts-Universität (CAU) in Kiel haben unbürokratisch und schnell bei der vorläufigen Lösung finanzieller Probleme in Verbindung mit dem Krankheitsfall geholfen.

Der weite Vorstoß in die zentrale Arktis wäre nicht ohne die bereitwillige Zusammenarbeit der Herren Mahler und Lundström von der Fa. Helikopter Service Wasserthal GmbH in Hamburg möglich gewesen. Die Wetterberatung durch Mitarbeiter des Seewetteramtes Hamburg wurde durch Eiskarten ergänzt, die uns durch Herrn Strübing vom Deutsches Hydrgraphisches Institut übermittelt wurden.

Die wissenschaftlichen Arbeiten der Expeditionsteilnehmer, die aus 19 renommierten Forschungsinstitutionen in Deutschland, USA, Kanada, Frankreich, England, Norwegen, Schweden und der Schweiz kamen, sind durch nationale Förderorganisationen finanziell ermöglicht worden. Wichtige Beiträge wurden in Deutschland u. a. vom Bundesministerium für Forschung und Technologie (BMFT) und der Deutschen Forschungsgemeinschaft (DFG) geleistet, in den USA vor allem von Office of Naval Research und National Science Foundation.

Das Forschungsprogramm in dem vom Königreich Norwegen beanspruchten Teil des Kontinentalrandes der nördlichen Barentssee ist durch die Forschungslizenz 242/87 (vom 5. Juni 1987) des Oljedirektorat (Norwegian Petroleum Directorate) in Stavanger genehmigt worden. Der norwegische Sysselmann (Gouverneur) auf Svalbard, Herr Leif Eldring, und seine Mitarbeiter haben uns ebenfalls hilfreich beraten.

Die Universität Tromsø hat uns während der Hafentage in Tromsø mit ihrer Informationsabteilung geholfen, eine lokale Pressekonferenz und einen Empfang für die Prominenz Tromsøs sowie der neuen Fahrtteilnehmer an Bord der POLARSTERN zu organisieren. Die deutsche Botschaft in Oslo und der deutsche Honorarkonsul in Tromsø unterstützten uns bei der Lösung administrativer Probleme.

Allen genannten Personen und Institutionen sei nach Abschluß dieses ehrgeizigen, wissenschaftlichen Vorhabens, von den wissenschaftlichen Expeditionsteilnehmern für ihren Beitrag zum Gelingen dieses Vorstoßes in die zentrale östliche Arktis gedankt.

3.4. STATIONSLISTE

Date 1987	St. No.	Time (UTC) Start End	Latitude	Longitude	Depth (m) uncorr.	Acti- vity	PD/Score (m)
July	268	15.55	81°15,8'N	31°19,0'E	210	XBT	
07.	269	16.12	81°16,3'N	31°23,5'E	198	XBT	
		16.37	81°16,2'N	31°23,5'E	198	SD/PN	
		16.37	81°16,2'N	31°23,5'E	198		
		18.11	81°16,3'N	31°24,0'E	198	IC/SW	
		16.47 16.52	81°16,2'N	31°23,5'E	198	BO	
		17.01 17.11	81°16,3'N	31°23,9'E	198	BRO	
		17.10	81°16,3'N	31°23,5'E	198	XCP	
		17.53	81°16,3'N	31°24,0'E	198	CTD	
		18.03 18.20	81°16,3'N	31°24,0'E	198	MN 300	
		18.40	81°16,3'N	31°24,0'E	198		
		20.16	81°16,3'N	31°25,0'E	200	WS	
		20.19	81°16,3'N	31°25,4'E	200		
		21.17	81°16,3'N	31°26,2'E	200	IC	
		20.20	81°16,3'N	31°25,4'E	200		
		20.33	81°16,3'N	31°25,6'E	200	MN 63	180m
		20.29	81°16,3'N	31°25,7'E	201	FC	
		20.42	81°16,3'N	31°26,1'E	199	GKG	0.37/0.37
		21.06	81°16,3'N	31°26,5'E	200	GKG	0.41/0.41
	270	22.22	81°19,0'N	31°16,6'E	219	XBT	
	271	22.42	81°21,3'N	31°23,5'E	219	XBT	
	272	22.47	81°20,0'N	31°19,5'E	200	XCP	
	273	23.14	81°24,4'N	31°24,5'E	192	XBT	
	274	23.51	81°26,3'N	31°21,4'E	264	XBT	
		23.55 00.12	81°26,2'N	31°20,2'E	255	MN 63	245m
08.		00.02 00.06	81°26,2'N	31°20,1'E	256	SD/PN	
		00.19	81°26,2'N	31°20,3'E	257		
		00.27	81°26,2'N	31°20,4'E	261	BO	
		00.32	81°26,2'N	31°20,4'E	257		
		00.45	81°26,3'N	31°20,3'E	257	XCP	
		01.07	81°26,2'N	31°21,3'E	248	CTD	
		01.11	81°26,2'N	31°21,3'E	247		
		01.31	81°26,2'N	31°21,5'E	240	MN 300	
		01.41	81°26,3'N	31°21,6'E	239	GKG	0.00/0.00
		01.59	81°26,3'N	31°22,1'E	237	GKG	0.00/0.00
		02.17	81°26,3'N	31°23,0'E	236	GKG	0.00/0.00
	275	03.24	81°29,6'N	31°23,3'E	574	XBT	
	276	03.48 03.54	81°29,2'N	31°25,9'E	571	BO	
		03.59 04.23	81°29,2'N	31°25,9'E	571	MN 300	500m
		03.59	81°31,1'N	31°25,4'E	571	XCP	
		04.41	81°29,2'N	31°28,1'E	571	IC	
		04.27	81°29,2'N	31°27,4'E	573		
		05.17	81°29,2'N	31°22,2'E	573	CTD	
		05.21 05.49	81°29,4'N	31°22,2'E	567	MN 63	500m
		05.37	81°29,3'N	31°22,2'E	567		
		06.16	81°29,3'N	31°23,4'E	570	IC	

Date 1987	St. No.	Time (UTC) Start End	Latitude	Longitude	Depth (m)	Acti- vity	PD/Score (m) or no
July 08.		06.04	81°29,6'N	31°22,6'E	569	GKG	0.00/0.
		06.35	81°29,7'N	31°22,7'E	570	GKG	0.00/0.
		06.32 06.36	81°29,3'N	31°23,5'E	571	PN/SD	
		07.27	81°29,4'N	31°23,7'E	574		
		07.38	81°29,7'N	31°24,6'E	582	GKG	0.50/0.
		08.27	81°29,7'N	31°26,5'E	577	GKG	0.50/0.
	277	09.24	81°30,0'N	31°28,0'E	710	XBT	
	278	10.27	81°31,5'N	31°29,3'E	773		
		10.58	81°31,5'N	31°30,1'E	759	MN 63	500m
		12.13	81°31,5'N	31°32,0'E	750		
		13.09	81°31,5'N	31°33,1'E	738	CTD	
		12.06	81°31,5'N	31°31,5'E	750	XCP	
		12.51	81°31,5'N	31°32,5'E	745	IC	
		13.15	81°31,5'N	31°33,1'E	738		
		14.20	81°31,5'N	31°34,1'E	721	HM	
		14.43	81°31,3'N	31°33,9'E	717	GKG	0.48/0.
		14.57	81°31,9'N	31°35,1'E	712	PN/SD	
		15.32	81°31,8'N	31°34,6'E	701	GKG	0.48/0.
		16.40	81°31,8'N	31°35,4'E	703	HF	
	279	17.38	81°32,5'N	31°36,5'E	851	XBT	
	280	18.36	81°34,9'N	31°36,4'E	1021	XCP	
		20.51 21.00	81°34,5'N	31°36,2'E	1027	BO	
		18.36	81°34,9'N	31°36,4'E	1021	XCP	
		21.04 21.12	81°34,5'N	31°36,2'E	1016	BO	
		21.04	81°34,6'N	31°36,2'E	1021		
		23.33	81°34,4'N	31°37,4'E	946	IC/LA	
		21.15	81°34,5'N	31°36,2'E	1015		
		21.24	81°34,5'N	31°36,3'E	1010	BRO	
		21.29	81°34,5'N	31°36,3'E	1007		
		22.47	81°34,4'N	31°37,2'E	969	CTD	
		22.19	81°34,5'N	31°37,1'E	972	PN	
		22.33	81°34,4'N	31°37,1'E	963	SD	
		22.51	81°34,4'N	31°37,2'E	963		
		23.21	81°34,4'N	31°37,4'E	952	MN 63	500m
		23.28	81°34,4'N	31°37,4'E	951		
09.		00.42	81°34,4'N	31°38,4'E	902	HM	
		00.46	81°34,4'N	31°38,4'E	905		
		02.36	81°34,3'N	31°39,0'E	887	LVS	
		02.40	81°34,5'N	31°39,1'E	882		
		03.05	81°34,6'N	31°38,9'E	887	MN 300	500m
		03.34	81°34,5'N	31°39,7'E	884	GKG	0.40/0.
		04.24	81°34,5'N	31°39,0'E	886	GKG	0.40/0.
		05.16	81°34,5'N	31°38,5'E	886	HF	
		08.15	81°34,9'N	31°36,4'E	974	XBT	
		281	09.11	81°34,9'N	31°38,2'E	1388	XBT
282	09.32	81°35,5'N	31°33,1'E	1384			
		10.03	81°35,5'N	31°33,0'E	1392	MN 300	500m
		09.47	81°35,5'N	31°33,1'E	1399		
		10.30	81°34,6'N	31°38,1'E	1390	IC/SD/PN	

Date 1987	St. No.	Time (UTC) Start End	Latitude	Longitude	Depth (m)	Acti- vity	PD/Score (m)or no
July		10.08	81°35,5'N	31°33,0'E	1399		
09.		11.40	81°35,5'N	31°32,4'E	1395	CTD	
		10.15	81°34,9'N	31°32,4'E	1398	XCP	
		11.47	81°35,5'N	31°32,4'E	1400		
		13.00	81°35,5'N	31°32,0'E	1406	HM	
		13.02 13.15	81°35,5'N	31°32,0'E	1409	MN 63	200m
		13.49	81°35,8'N	31°32,1'E	1410	GKG	0.45/0.45
		14.57	81°35,8'N	31°31,5'E	1404	GKG	0.43/0.43
		15.59	81°35,8'N	31°31,1'E	1439	HF	
		17.37	81°35,8'N	31°30,0'E	1436	KAL6	3.80/3.00
	283	18.12	81°35,8'N	31°29,4'E	1436	XBT	
	284	18.31	81°36,0'N	31°30,4'E	1616	XBT	
	285	19.20	81°38,7'N	31°30,6'E	1822		
		22.16	81°38,7'N	31°26,7'E	1926	IC	
		19.26 19.49	81°38,7'N	31°30,6'E	1843	MN 63	500m
		19.47	81°38,7'N	31°29,5'E	1862	SD	
		19.53	81°38,5'N	31°30,7'E	1841	PN	
		19.54 20.05	81°38,5'N	31°30,7'E	1862	BO	
		20.03	81°38,5'N	31°30,7'E	1891	GM	
		20.18 20.26	81°38,5'N	31°30,3'E	1891	BO	
		20.33 20.41	81°38,6'N	31°30,2'E	1890	BRO	
		19.01	81°38,6'N	31°30,0'E	1900		
		22.24	81°38,5'N	31°28,7'E	1918	CTD	
		19.10	81°38,6'N	31°30,0'E	1900	XCP	
		22.29	81°38,4'N	31°28,5'E	1813		
		22.57	81°38,4'N	31°28,1'E	1917	MN 300	
10.		23.46	81°38,6'N	31°27,6'E	1933	GKG	0.70/0.70
		01.27	81°38,5'N	31°26,1'E	2063	GKG	0.70/0.70
		03.26	81°38,2'N	31°23,2'E	2301	KAL6	3.00/2.70
		05.08	81°38,1'N	31°21,5'E	2293	HF	
	286	05.45	81°38,1'N	31°20,9'E	2223	XBT	
	287	07.55	81°40,7'N	31°12,1'E	2572		
		08.45	81°41,1'N	31°08,3'E	2626	IC	
		07.55 08.03	81°40,7'N	31°12,1'E	2572	BO/SD	
		08.05 08.14	81°40,6'N	31°12,1'E	2591	BO	
		08.24	81°40,5'N	31°11,5'E	2603		
		08.33	81°40,5'N	31°11,3'E	2626	BRO	
		08.40	81°40,5'N	31°11,2'E	2622		
		10.57	81°41,0'N	31°07,5'E	2814	CTD	
		08.40	81°40,8'N	31°10,7'E	2814	XCP	
		09.20	81°41,1'N	31°10,5'E	2814	XBT	
		10.29	81°41,0'N	31°07,5'E	2783	PN	
		11.24	81°41,0'N	31°06,6'E	2806		
		14.28	81°40,6'N	31°02,4'E	2819	HM	
		13.28	81°40,6'N	31°03,4'E	2775	IC/SW/XCP	
		14.33	81°40,6'N	31°03,4'E	2785		
		15.00	81°40,6'N	31°02,1'E	2866	MN 300	500m
		15.07	81°40,6'N	31°02,0'E	2867	IC	

Date 1987	St. No.	Time (UTC) Start End	Latitude	Longitude	Depth (m)	Acti- vity	PD/Scor (m) or n
July		18.05	81°41,0'N	31°00,0'E	2860	LVS	
10.		17.49	81°41,1'N	31°00,1'E	2764	XBT	
		18.20	81°41,2'N	30°59,9'E	2705		
		18.48	81°40,9'N	31°01,0'E	2696	MN 63	500
		18.56	81°40,9'N	31°01,5'E	2696		
		19.55	81°41,0'N	30°54,0'E	2735	CTD	
		19.59	81°41,0'N	30°54,0'E	2729		
11.		04.07	81°40,0'N	30°53,0'E	2834	P	
		05.25	81°40,7'N	30°53,3'E	2838	LVS	
		06.35	81°40,6'N	30°52,6'E	2671	GKG	0.40/0
		08.54	81°40,4'N	30°51,0'E	2876	GKG	0.40/0
		10.40	81°40,3'N	30°49,9'E	2837	GKG	0.35/0
		12.28	81°40,0'N	30°49,2'E	2743	KAL6	0.00/0
		14.16	81°39,6'N	30°48,7'E	2680	HF	
		15.34	81°39,4'N	30°48,5'E	2611		
		16.44	81°39,3'N	30°48,1'E	2506	LVS	
		16.05	81°39,2'N	30°48,2'E	2558		
		17.40	81°38,0'N	30°48,1'E	2588	IC	
		16.54	81°39,0'N	30°48,1'E	2503		
12.		02.45	81°37,5'N	30°41,2'E	2125	P	
11.		20.05	81°38,4'N	30°44,2'E	2336	XBT	
		21.01	81°38,0'N	30°43,0'E	2326	XBT	
		22.23	81°31,9'N	30°41,1'E	2326	XBT	
		23.57	81°37,6'N	30°41,0'E	2184	XBT	
12.		02.00	81°37,7'N	30°40,2'E	2170	XBT	
	288	03.22	81°38,3'N	30°50,8'E	2721	XBT	
	289	03.55	81°39,2'N	30°55,6'E	2685	XBT	
	290	04.27	81°40,4'N	31°02,6'E	2637	XBT	
	291	04.58	81°41,4'N	31°13,0'E	2548	XBT	
	292	07.00	81°42,6'N	31°12,8'E	2540	XBT	
	293	08.05	81°45,4'N	31°29,7'E	2491	XBT	
	294	09.05	81°46,0'N	31°29,5'E	2364	XBT	
	295	12.40	81°47,6'N	31°35,1'E	2980	XBT	
	296	13.42	81°48,4'N	31°34,5'E	3012		
		14.47	81°48,3'N	31°34,5'E	3008	CTD	
		14.23	81°48,4'N	31°34,5'E	3009	PN/SD	
		14.51	81°48,3'N	31°34,5'E	3008	BO	
		15.01	81°48,3'N	31°34,5'E	3008	BO	
		15.12	81°48,3'N	31°34,5'E	3009	BRO	
		15.24	81°48,2'N	31°34,5'E	3009	MN 63	500m
		15.32	81°48,6'N	31°35,3'E	3009	XCP	
		15.51	81°48,6'N	31°35,7'E	3010		
		16.39	81°48,4'N	31°34,6'E	3006	HM	
		16.23	81°48,4'N	31°34,2'E	3011		
		16.48	81°48,3'N	31°34,7'E	3006	FC-boat	
		16.51	81°48,3'N	31°34,7'E	3006		
		17.21	81°48,2'N	31°35,1'E	3005	MN 300	500m
		16.57	81°48,3'N	31°34,6'E	3007		
		17.18	81°48,2'N	31°35,1'E	3005	FC-boat	
		17.29	81°48,2'N	31°33,9'E	3008		
		19.59	81°47,9'N	31°32,6'E	3011	CTD	

Date	St. No.	Time (UTC) Start End	Latitude	Longitude	Depth (m)	Acti- vity	PD/Score (m) or no
July	2.	20.54	81°47,6'N	31°31,2'E	3008	GKG	0.35/0.35
		19.00 20.20	81°47,6'N	31°31,1'E	3009	IC	
3.		22.37	81°47,5'N	31°30,3'E	3004	GKG	0.34/0.34
		00.24	81°47,4'N	31°30,1'E	2998	KAL12	6.50/5.10
		02.05	81°47,3'N	31°30,1'E	2998	HF	
	297	03.17	81°47,0'N	31°32,2'E	2812	XBT	
	298	04.27	81°48,9'N	31°40,4'E	3015	XBT	
	299	04.48	81°50,0'N	31°44,0'E		XBT	
	300	05.04	81°51,2'N	31°49,9'E	2972	XBT	
	301	06.12	81°54,6'N	31°47,9'E	3007	XBT	
	302	06.45	81°57,6'N	31°36,4'E	3009	XBT	
	303	07.16	81°59,3'N	31°37,7'E	3012	XBT	
	304	08.06	82°02,9'N	31°52,0'E	3026	XBT	
	305	08.46	82°04,4'N	31°47,9'E	3061	XBT	
	306	09.59	82°05,0'N	31°47,4'E	3076	XBT	
	307	10.53	82°04,6'N	31°47,6'E	3083	XBT	
	308	12.14	82°07,5'N	31°48,6'E	3072	XBT	
	309	12.31	82°08,5'N	31°50,8'E	3072	XBT	
	310	12.55	82°09,3'N	31°54,2'E	3059		
		15.31	82°08,8'N	31°54,2'E	3040	CTD	
		13.00 13.41	82°09,2'N	31°54,2'E	3059	IC	
		13.30	82°10,0'N	31°54,2'E	3056	XCP	
		15.35	82°08,8'N	31°54,1'E	3039		
		15.44	82°08,2'N	31°56,3'E	3038	BO/PN/SD	
		15.51	82°08,2'N	31°56,6'E	3037		
		15.59	82°08,2'N	31°56,9'E	3032	BRO	
		16.04	82°08,2'N	31°57,1'E	3032		
		16.27	82°08,1'N	31°58,1'E	3028	MN 300	500m
		16.31	82°08,1'N	31°58,2'E	3029		
		19.15	82°05,7'N	32°02,0'E	3017	HM	
		18.34	82°06,1'N	32°00,0'E	3019		
		19.15	82°05,7'N	32°02,0'E	3017	IC	
		19.21	82°05,7'N	32°01,5'E	3017		
		20.48	82°04,5'N	32°02,5'E	3004	CTD	
		20.54	82°04,4'N	32°03,0'E	3003		
		21.12	82°04,3'N	32°03,2'E	3002	MN 63	500
		22.08	82°0' N	32°0' E	3009	GKG	0.40/0.40
		23.47	82°0' N	32°0' E	2981	GKG	0.35/0.35
14.		01.34	82°02,2'N	32°08,5'E	2961	KAL12	0.00/0.00
		03.14	82°01,3'N	32°13,4'E	2929	HF	
		04.56	82°00,5'N	32°19,1'E	2880	KAL6	1.50/0.98
	311	06.07	82°00,1'N	32°24,8'E	2850	XBT	
	312	07.00	82°03,2'N	32°30,6'E	2859	XBT	
	313	08.25	82°03,5'N	32°14,1'E	2810	XBT	
	314	09.02	82°04,7'N	32°12,0'E	2992	XBT	
	315	09.31	82°06,5'N	31°53,4'E	3030	XBT	
	316	19.10	82°07,6'N	32°12,1'E	3042	XBT	
	317	19.43	82°08,5'N	31°55,6'E	3049	XBT	
	318	22.50	82°11,6'N	32°16,7'E	2999	XBT	
15.		319	82°13,2'N	32°19,0'E	3072	XBT	
	320	08.27	82°15,7'N	32°15,6'E	3109	XBT	

Date 1987	St. No.	Time (UTC) Start End	Latitude	Longitude	Depth (m)	Acti- vity	PD/Score (m) or no
July 15.	321	11.22	82°19,8'N	32°00,7'E	3242	XBT	
	322	12.07	82°21,2'N	31°59,6'E	3249	XBT	
	323	12.46	82°22,4'N	32°00,5'E	3380	XBT	
	324	13.06	82°22,7'N	32°01,4'E	3024	XBT	
	325	14.40	82°24,8'N	32°16,5'E	2799	XBT	
	326	15.44	82°25,6'N	32°39,6'E	3269	XBT	
	327	16.28	82°26,8'N	32°46,4'E	3295	XBT	
	328	18.10	82°28,3'N	32°56,0'E	3280	XBT	
	329	18.28	82°28,7'N	32°53,1'E	3275	XBT	
	330	20.55	82°24,5'N	31°24,2'E	2745		
16.	331	00.35	22.47 82°24,1'N	31°17,0'E	2745	IC	
		01.11	82°24,9'N	31°01,5'E	3462	XBT	
	332	02.48	82°24,2'N	31°03,9'E	3500	XBT	
	333	04.14	82°24,0'N	30°46,5'E	3792	XBT	
	334	06.07	82°25,6'N	30°37,7'E	3539	XBT	
	335	07.23	82°30,4'N	30°57,4'E	3528	XBT	
	336	13.40	82°30,8'N	31°11,3'E	3529	XBT	
		17.17	82°31,4'N	30°54,4'E	3589	XBT	
	337	20.43	82°39,1'N	31°39,9'E	3670	XBT	
	338	21.18	82°48,1'N	31°24,8'E	3655	XBT	
339	22.40	82°50,5'N	31°25,3'E	3684	XBT		
17.	340	06.25	82°54,2'N	31°46,4'E	3736	XBT	
		07.37	83°00,5'N	31°53,7'E	3789		
	06.39	07.37	82°59,6'N	31°59,2'E	3788	IC/LA	
	09.32	06.45	83°00,5'N	31°53,7'E	3789		
		09.37	82°59,2'N	31°58,6'E	3785	LVS	
	10.54	06.45	83°00,5'N	31°52,9'E	3788	XCP	
		09.37	82°59,1'N	31°58,6'E	3784		
	11.05	10.57	82°59,0'N	31°58,5'E	3781	CTD	
		11.20	82°59,0'N	31°58,8'E	3781		
	11.28	11.05	82°59,0'N	31°58,5'E	3781	BO/PN/SD	
11.35		82°58,6'N	31°58,4'E	3780			
11.35	11.35	82°58,6'N	31°58,4'E	3780	BRO		
	11.51	82°58,6'N	31°58,3'E	3780	GM		
12.56	11.58	82°58,5'N	31°58,3'E	3779	MN 300	500m	
	13.16	82°58,4'N	31°58,4'E	3779			
15.50	12.56	82°58,5'N	31°59,1'E	3778	HM		
	16.44	82°58,5'N	32°00,0'E	3776			
17.00	16.44	82°58,5'N	32°00,0'E	3777	CTD		
	17.04	82°59,0'N	32°00,0'E	3766			
18.53	17.04	82°59,0'N	32°00,0'E	3766	MN		
	19.00	82°59,0'N	31°59,0'E	3766			
19.20	19.00	82°59,0'N	31°59,8'E	3760	LVS		
	20.18	82°59,6'N	31°59,8'E	3760			
22.11	20.18	82°54,0'N	31°59,0'E	3760	MN 63	500m	
	00.06	82°58,2'N	32°03,0'E	3755	GKG	0.28/0.1	
01.12	22.11	82°57,0'N	32°03,5'E	3755	GKG	0.28/0.1	
	02.00	82°56,5'N	32°05,0'E	3752	KAL6	5.75/4.1	
18.	01.12	02.00	82°56,6'N	32°04,5'E	3752		
		02.00	82°56,6'N	32°04,2'E	3751	HF	

Date 1987	St. No.	Time (UTC) Start End	Latitude	Longitude	Depth (m)	Acti- vity	PD/Score (m)or no	
July 18.		03.05	82°57,0'N	32°04,5'E	3750			
		05.17	82°57,0'N	32°04,5'E	3746	LVS		
		03.25	82°57,0'N	32°04,5'E	3749	XBT		
		05.28	82°57,0'N	32°04,5'E	3746	SL12	1.00/0.00	
		08.50	82°56,5'N	32°09,3'E	3744			
		10.30	82°56,5'N	32°09,2'E	3743	FC		
		09.00	82°56,5'N	32°09,2'E	3744			
		12.00	82°57,0'N	32°09,1'E	3742	CTD		
		09.35	82°56,5'N	32°09,2'E	3744			
		12.11	82°57,0'N	32°09,1'E	3742	IC		
		12.03	82°57,0'N	32°09,1'E	3742			
		15.42	82°56,6'N	32°10,3'E	3742	HM		
		15.46	82°56,6'N	32°08,3'E	3742			
		15.51	82°56,5'N	32°08,3'E	3742	BRO		
		17.41	82°56,4'N	32°10,6'E	3740	KOL12	4.00/3.53	
		16.30	82°56,5'N	32°07,3'E	3740			
		18.00	82°56,4'N	32°10,6'E	3742	IC		
		19.27	82°56,3'N	32°09,5'E	3737			
	19.		21.15	82°56,0'N	32°08,2'E	3733	HF	
			21.20	82°56,0'N	32°08,2'E	3732		
		21.48	82°55,4'N	32°07,5'E	3732	MN 63	500m	
		21.53	82°55,4'N	32°07,5'E	3732			
		23.27	82°55,3'N	32°07,3'E	3730	LVS		
		23.32	82°55,3'N	32°07,4'E	3730			
		23.43	82°55,3'N	32°07,4'E	3730	MN 300	200m	
		00.17	82°55,3'N	32°08,2'E	3728			
		02.10	82°55,2'N	32°10,3'E	3720	CTD		
		03.10	82°55,1'N	32°11,4'E	3720	KAL6	1.50/0.00	
		04.17	82°54,7'N	32°14,4'E	3711			
		06.01	82°54,4'N	32°15,5'E	3706	HM		
		06.58	82°53,9'N	32°16,7'E	3703	KAL6	2.50/1.00	
		07.20	82°53,9'N	32°16,5'E	3703			
		07.46	82°53,9'N	32°16,7'E	3700	IC		
		08.07	82°53,8'N	32°17,0'E	3699	XBT		
		341	10.28	82°53,8'N	32°19,0'E	3688	XCP	
20.			342	83°03,7'N	31°26,7'E	3856	XBT	
			343	83°07,6'N	30°45,2'E	3912	XBT	
		345	83°08,0'N	30°38,3'E	3925	XBT		
		346	83°06,9'N	30°41,0'E	3937	XCP		
		347	83°12,1'N	30°40,6'E	3953	XBT		
		348	83°26,4'N	30°43,4'E	3978	XBT		
		349	83°24,3'N	30°25,6'E	3997	XBT		
		350	23.19	83°26,6'N	30°11,0'E	4011	GM	
		23.10	83°29,9'N	30°10,4'E	4012			
		00.25	83°26,5'N	30°12,5'E	4011	IC		
		351	02.43	83°29,2'N	30°15,2'E	4025	XBT	
	352	06.23	83°37,9'N	29°57,2'E	4285	XBT		
	352A	07.45	83°43,7'N	30°22,4'E	3985	XCP		
	353	08.31	83°42,0'N	30°12,4'E	4100	XBT		
	354	10.59	83°48,7'N	30°31,5'E	4041	XBT		
	355	13.08	83°49,5'N	30°36,5'E	4040	XCP		

Date 1987	St. No.	Time (UTC) Start End	Latitude	Longitude	Depth (m)	Acti- vity	PD/Score (m)or no
July 20.	356	14.22	83°54,0'N	30°47,0'E	4042	XBT	
	357	15.26	83°56,9'N	30°48,1'E	4041	XBT	
	358	18.40	84°01,4'N	30°22,7'E	4045		
21.		20.22	84°02,3'N	30°41,6'E	4045	IC	
		18.57	84°01,4'N	30°22,7'E	4045		
		21.47	84°02,2'N	30°37,0'E	4045	LVS	
		21.54	84°02,2'N	30°36,6'E	4045		
		00.49	84°02,2'N	30°37,5'E	4045	CTD	
		00.53	84°02,2'N	30°37,4'E	4045		
		10.33	84°01,5'N	30°35,2'E	4045	P	
		08.24	84°01,5'N	30°36,3'E	4045		
		16.48	84°01,4'N	30°30,1'E	4044	IC	
		10.45	84°01,6'N	30°30,5'E	4045	GM	
		11.20	84°01,5'N	30°34,5'E	4045		
		19.20	84°01,2'N	30°24,7'E	4044	SS	
		11.27	84°01,5'N	30°34,4'E	4044		
		11.34	84°01,5'N	30°34,4'E	4044	BO/FL/PN/SD	
		11.40	84°01,5'N	30°34,2'E	4045		
		11.47	84°01,5'N	30°33,5'E	4045	BO	
		11.53	84°01,5'N	30°33,5'E	4045		
		11.59	84°01,5'N	30°33,5'E	4045	BRO	
		12.06	84°01,5'N	30°34,1'E	4045		
		12.30	84°01,5'N	30°34,1'E	4044	IC	
		12.12	84°01,5'N	30°34,2'E	4045		
	12.32	84°01,5'N	30°34,1'E	4044	MN 300	500m	
	12.36	84°01,5'N	30°34,1'E	4044			
	16.00	84°01,6'N	30°31,1'E	4044	HM		
	16.21	84°01,6'N	30°31,2'E	4044	XBT		
	16.10	84°01,6'N	30°31,2'E	4044			
	17.32	84°01,4'N	30°29,1'E	4044	CTD		
	16.45	84°01,6'N	30°30,4'E	4044	XBT		
	17.35	84°01,4'N	30°29,1'E	4044			
	19.11	84°01,2'N	30°24,9'E	4044	LVS		
	18.30	84°01,4'N	30°27,1'E	4044			
	19.13	84°01,2'N	30°24,8'E	4044	IC		
	19.31	84°01,2'N	30°24,3'E	4044			
	19.52	84°01,1'N	30°24,6'E	4044	MN 63	500m	
	21.00	84°01,1'N	30°22,1'E	4045	GKG	0.36/0.36	
	22.54	84°00,6'N	30°19,0'E	4045	GKG	0.36/0.36	
22.	00.54	84°00,5'N	30°15,5'E	4045	SL12	0.50/0.00	
	02.50	84°00,4'N	30°13,0'E	4045	HF		
	05.46	84°00,0'N	30°07,0'E	4046	KAL6	0.20/0.00	
	06.54	83°59,8'N	30°04,9'E	4046			
	09.38	83°59,2'N	30°00,0'E	4046	LVS		
	09.10	83°59,2'N	30°00,2'E	4046			
	11.37	83°59,1'N	29°56,4'E	4047	IC		
	09.45	82°59,2'N	29°59,2'E	4046			
	17.40	83°58,1'N	29°50,7'E	4047	P		
	12.12	83°59,0'N	29°56,5'E	4047			
14.00	83°58,3'N	29°56,3'E	4047	FC			
18.45	83°57,8'N	29°48,9'E	4047	SL6	0.00/0.00		

Date 1987	St. No.	Time (UTC)		Latitude	Longitude	Depth (m)	Acti- vity	PD/Score (m) or no
		Start	End					
July	359	23.22		84°26,2'N	29°43,6'E	4044		
23.			00.53	84°26,1'N	29°43,1'E	4043	IC	
		23.22	00.53	84°35,8'N	30°01,2'E	4043	B	
24.		10.49		84°25,6'N	29°44,0'E	4043	GM	
25.	360	00.12		84°35,8'N	29°19,8'E	4038	GM	
	361	09.45		85°00,4'N	29°27,2'E	4372	IC/SW	
		16.31		85°07,0'N	29°19,9'E	4037	GM	
26.	362	03.33		85°04,5'N	29°22,1'E	4037		
			05.09	85°00,7'N	29°18,2'E	4037	CTD	
			03.38	85°04,3'N	29°23,6'E	4037		
			04.30	85°04,1'N	29°16,0'E	4037	IC	
			05.38	85°04,2'N	29°18,9'E	4037		
			08.30	85°04,6'N	29°21,4'E	4037	LVS	
			07.50	85°04,5'N	29°21,7'E	4037	SD	
			08.32	85°04,6'N	29°29,4'E	4037		
			08.40	85°04,6'N	29°29,4'E	4037	BO/PN/SD	
			08.41	85°04,6'N	29°21,5'E	4037		
			08.48	85°04,6'N	29°21,6'E	4037	BO	
			08.54	85°04,6'N	29°21,6'E	4037		
			09.04	85°04,7'N	29°21,6'E	4037	BRO	
			09.07	85°04,7'N	29°21,6'E	4037		
			10.21	85°04,8'N	29°21,3'E	4037	HM	
			10.25	85°04,8'N	29°21,3'E	4037		
			10.46	85°04,8'N	29°20,8'E	4038	MN 63	500m
			10.51	85°04,8'N	29°20,8'E	4037		
			13.48	85°05,0'N	29°17,9'E	4037	CTD	
	362	13.50		85°05,0'N	29°17,8'E	4037		
			15.35	85°05,0'N	29°13,8'E	4037	LVS	
			15.37	85°05,0'N	29°13,8'E	4037		
			15.46	85°04,9'N	29°13,7'E	4037	MN 300	500m
			16.39	85°04,2'N	29°17,1'E	4037	XCP	
			16.58	85°04,9'N	29°11,2'E	4037	GKG	0.26/0.26
			18.54	85°04,6'N	29°07,6'E	4037	GKG	0.24/0.24
			18.23	85°04,7'N	29°08,0'E	4037		
			19.28	85°04,3'N	29°04,8'E	4037	IC	
			20.57	85°03,5'N	28°57,6'E	4037	SL6	6.00/5.62
			22.47	85°03,0'N	28°47,1'E	4037	HF	
27.		01.05		85°02,1'N	28°31,3'E	4037	KAL12	1.00/0.00
		00.23		85°02,2'N	28°36,1'E	4038		
			02.02	85°01,8'N	28°23,3'E	4038	IC	
		00.23	02.02	85°02,5'N	28°33,9'E	4038	B	
			04.16	85°01,4'N	28°08,4'E	4038	KAL12	7.50/5.82
	363	11.45		85°25,8'N	25°57,1'E	3634	GM	
	364	12.52		85°21,5'N	26°19,9'E	3634	GKG	0.38/0.38
		15.09		85°21,8'N	26°12,9'E	3646	KAL6	5.50/4.23
		14.45		85°21,7'N	26°15,5'E	3652		
			17.11	85°22,4'N	26°06,1'E	3658	IC/LA	
			15.53	85°22,0'N	26°10,3'E	3652	XCP	
			16.01	85°22,0'N	26°10,5'E	3670		
			17.23	85°22,2'N	26°04,8'E	3655	CTD	
			16.17	85°22,1'N	26°09,3'E	3669		
			16.20	85°22,3'N	26°09,5'E	3669	PN/SD	

Date 1987	St. No.	Time (UTC) Start End	Latitude	Longitude	Depth (m)	Acti- vity	PD/Score (m) or nr		
July 28.	365	18.11	85°22,3'N	26°02,8'E	3651	HF			
		13.30 14.21	85°31,1'N	25°17,0'E	3137	B/SD/IC/PN			
		13.42	85°33,0'N	25°20,2'E	3137	GM			
		14.04	85°30,8'N	25°17,8'E	3127	GKG	0.35/0.		
		14.48	85°30,9'N	25°14,8'E	3269				
		17.19	85°31,8'N	25°12,6'E	3368	CTD			
		15.20	85°31,3'N	25°17,5'E	3362				
		16.10	85°31,4'N	25°17,7'E	3366	IC			
		15.48	85°31,4'N	25°17,5'E	3366	XCP			
		18.27	85°32,2'N	25°19,4'E	3366	KAL6	4.00/0.		
		20.16	85°32,4'N	25°19,4'E	3347	KAL6	4.50/3.		
		21.47	85°32,8'N	25°21,0'E	3387	HF			
		29.	366	09.11	85°43,4'N	26°32,0'E	3145	GM	
				12.02	85°41,2'N	26°30,2'E	3025	GM	
		30.	368	12.13	85°48,6'N	24°42,3'E	3440		
				14.05	85°49,2'N	24°21,3'E	3551	IC	
		31.	369 370	21.27	85°52,4'N	23°40,2'E	3724	GM	
				11.43	85°53,8'N	22°50,2'E	4450	HF	
		1. August	370	12.18	85°53,9'N	22°49,1'E	4461		
				15.10	85°53,9'N	22°45,0'E	4539	IC/XCP	
13.12	85°54,0'N			22°46,3'E	4529				
16.26	85°54,1'N			22°44,1'E	4569	CTD			
13.14	85°53,4'N			22°43,8'E	4507	XCP			
17.36	85°54,1'N			22°43,4'E	4569	KAL12	0.50/0.		
19.05	85°54,2'N			22°42,9'E	4648				
19.13	85°54,2'N			22°42,9'E	4655	BO/SD/PN			
19.16	85°54,2'N			22°43,2'E	4669				
19.22	85°54,3'N			22°43,4'E	4666	BO			
19.27	85°54,3'N			22°43,4'E	4595				
19.35	85°54,3'N			22°43,4'E	4605	BRO			
18.49	85°54,1'N			22°42,9'E	4569				
22.58	85°54,5'N			22°43,5'E	4675	IC/LA			
18.49	85°54,4'N			22°40,2'E	4620	B			
20.15	85°59,0'N			21°57,3'E	4655	GM, IC			
19.43	85°54,3'N			22°43,5'E	4656				
20.04	85°54,3'N			22°43,5'E	4651	MN 300	500m		
21.38	85°54,4'N			22°43,8'E	4674	SL6	6.00/4.		
23.10	85°54,5'N			22°43,2'E	4661				
1. August	370	09.24	85°55,4'N	22°46,1'E	5109	P			
		01.48	85°54,6'N	22°46,3'E	4688				
		18.41	85°56,1'N	22°39,7'E	5067	SS			
		09.27	85°55,4'N	22°46,5'E	5112				
		09.50	85°55,4'N	22°46,5'E	5156	MN 63	500m		
		10.12	85°55,4'N	22°47,0'E	5099				
		11.11	85°55,5'N	22°48,9'E	5124	HM			
		10.28	85°55,5'N	22°47,6'E	5129				
		11.57	85°55,5'N	22°48,9'E	5121	FC			
		11.16	85°55,5'N	22°48,9'E	5119				
		13.34	85°55,8'N	22°45,7'E	5200	CTD			
		11.51	86°03,7'N	22°40,0'E	5193	GM/IC			
15.03	85°55,9'N	22°44,0'E	5211	SL6	6.00/3.				
14.07	85°55,8'N	22°44,9'E	5211						

Date 1987	St. No.	Time (UTC) Start End	Latitude	Longitude	Depth (m)	Acti- vity	PD/Score (m)or no
August		15.49	85°56,0'N	22°43,5'E	5213	FC	
1.		16.17	85°56,0'N	22°43,9'E	5136		
		18.30	85°56,2'N	22°41,4'E	5071	HF	
2.		20.23	85°55,8'N	22°11,1'E	4508	GM	
3.	371	12.34	86°02,1'N	22°07,8'E	3777		
		15.15	86°03,0'N	21°58,7'E	3424	IC	
		16.08	86°03,4'N	21°55,6'E	3319		
		18.52	86°04,3'N	21°59,4'E	3300	CTD	
		18.58	86°04,3'N	21°59,4'E	3300		
		21.28	86°04,8'N	21°59,4'E	3545	HM	
		18.30	86°04,4'N	21°59,5'E	3200		
		20.33	86°04,5'N	21°49,7'E	3456	IC/GM/LA	
		21.32	86°04,8'N	21°59,4'E	3562		
		21.42	86°04,8'N	21°59,1'E	3562	BO/PN/SD	
		21.44	86°04,8'N	21°59,1'E	3562		
		21.51	86°04,9'N	21°59,1'E	3565	BO	
		21.55	86°04,9'N	21°59,1'E	3564		
		22.02	86°04,9'N	21°59,1'E	3564	BRO	
4.		23.03	86°05,1'N	21°58,9'E	3640	GKG	0.00/0.00
		00.00	86°05,2'N	22°00,4'E	3731		
		01.31	86°05,6'N	22°00,7'E	3697	LVS	
		02.36	86°05,8'N	22°01,0'E	3704	GKG	0.38/0.38
		03.31	86°06,0'N	22°01,1'E	3707		
		03.50	86°06,1'N	22°01,2'E	3730	MN 63	500m
		04.56	86°06,2'N	22°01,5'E	3725	KAL6	3.50/2.50
		05.56	86°06,4'N	22°01,5'E	3754		
		07.41	86°06,8'N	22°01,2'E	3841	CTD	
		06.10	86°06,4'N	22°01,5'E	3759		
		06.42	86°06,6'N	22°01,6'E	3759	IC/XBT	
		06.22	86°06,5'N	22°01,6'E	3841	XCP	
		08.20	86°07,1'N	22°01,7'E	3856		
		10.31	86°07,4'N	22°03,3'E	3937	IC/B	
		09.53	86°07,3'N	22°02,4'E	3896	GM	
		10.35	86°07,4'N	22°03,3'E	3935		
		13.11	86°07,9'N	22°04,3'E	3945	LVS	
		13.07	86°07,8'N	22°04,3'E	3929		
		18.41	86°08,9'N	22°02,3'E	3579	IC/B	
		14.13	86°08,1'N	22°05,2'E	3895	GKG	0.38/0.38
		13.46	86°08,0'N	22°04,2'E	3924		
		14.17	86°08,1'N	22°05,2'E	3875	FC	
		16.46	86°08,5'N	22°03,3'E	3780	KOL18	6.50/
		17.35	86°21,8'N	23°09,8'E		GM/IC	
		19.28	86°09,1'N	22°02,9'E	3520	HF	
		20.37	86°09,3'N	22°03,1'E	3613		
		22.49	86°09,7'N	22°04,3'E	3432	MN 300	2500m
6.	372	14.51	86°08,3'N	23°01,4'E	4029		
		16.18	86°08,1'N	23°05,3'E	3977	CTD/SD/PN	
		16.10	86°08,0'N	23°05,3'E	3977		
		17.50	86°08,0'N	23°07,1'E	4006	IC	

Date 1987	St. No.	Time (UTC) Start End	Latitude	Longitude	Depth (m)	Acti- vity	PD/Score (m) or no
August		17.23	86°08,0'N	23°07,0'E	3990	KAL6	3.25/2
6.		16.48	86°08,0'N	23°05,9'E	4033		
		20.47	86°07,8'N	23°10,9'E	3971	SS	
		18.20	86°07,9'N	23°08,5'E	4004		
		18.32	86°07,9'N	23°08,8'E	3964	BO	
		18.32	86°07,9'N	23°08,8'E	3966	BRO	
		19.50	86°07,8'N	23°09,5'E	3972	GKG	0.41/0
8.	373	10.45	85°50,5'N	23°34,0'E	4820	IC	
9.	374	19.43	85°48,6'N	21°40,8'E	3350	GM/SW	
10.	375	09.12	85°25,8'N	23°13,1'E	3006	GM/IC	
	376	11.54	85°22,9'N	21°55,3'E	2875		
		14.27	85°23,4'N	21°47,4'E	2879	CTD	
		12.27	85°22,9'N	21°54,7'E	2888		
		14.29	85°23,4'N	21°47,4'E	2879	IC	
		12.36	85°22,8'N	21°52,2'E	2869	XCP	
		12.42	85°22,9'N	21°54,4'E	2869		
		14.05	85°23,3'N	21°47,2'E	2881	IC, LA	
		13.12	85°22,9'N	21°54,4'E	2869		
		15.00	85°23,4'N	21°46,5'E	2882	FC	
		14.30	85°23,4'N	21°47,4'E	2880		
		14.52	85°23,4'N	21°46,5'E	2885	MN 63	500m
		15.45	85°23,6'N	21°46,8'E	2913	GKG	0.32/0
		17.29	85°23,1'N	21°44,1'E	2917	KAL6	4.50/3
		19.09	85°22,9'N	21°42,5'E	2896	GKG	0.31/0
		20.34	85°23,7'N	21°39,1'E	2912	HF	
		21.22	85°23,0'N	21°30,4'E	2890		
		21.41	85°22,9'N	21°38,0'E	2884	MN 300	500m
		21.45	85°22,9'N	21°38,0'E	2887		
		21.53	85°22,8'N	21°38,0'E	2885	BO/PN/SD	
		21.54	85°22,8'N	21°38,0'E	2885		
		22.01	85°22,7'N	21°37,6'E	2883	BO	
		22.04	85°22,7'N	21°37,6'E	2882		
		22.12	85°22,6'N	21°37,4'E	2880	BRO	
		23.42	85°22,6'N	21°21,8'E	2891	KOL18	6.50/4
11.		01.12	85°22,3'N	21°31,9'E	2912		
		02.16	85°22,2'N	21°29,3'E	2903	HM	
		03.14	85°22,1'N	21°28,3'E	2889	SL12	5.50/3
		04.53	85°22,0'N	21°22,9'E	2971	B	
12.	377	00.38	84°46,7'N	21°51,4'E	4334		
		01.42	84°43,8'N	22°23,5'E	3947	IC/LA	
	378	11.08	84°28,9'N	21°55,8'E	4048	GM	
	379	12.50	84°31,5'N	21°40,6'E	4054	GM/IC	
13.	380	10.41	83°49,7'N	20°25,0'E	4062	B/GM	
	381	10.45	83°49,7'N	20°25,0'E	4060	IC/SW	
		21.57	83°24,1'N	19°59,9'E	4064	CTD	
	382	22.15	83°24,3'N	20°01,1'E	4064		
		23.18	83°24,0'N	19°59,9'E	4064	IC/FC	
		22.55	83°24,0'N	20°01,1'E	4064	XCP	
14.		02.10	83°24,6'N	19°52,5'E	4066	GKG	0.60/0
		02.59	83°23,5'N	19°48,3'E	4064		
		04.16	83°23,8'N	19°50,6'E	4064	HM	
		05.14	83°23,4'N	19°42,4'E	4064	SL12	5.50/1

Date 1987	St. No.	Time (UTC) Start End	Latitude	Longitude	Depth (m)	Acti- vity	PD/Score (m)or no
August		06.07 10.48	83°22,5'N	19°50,3'E	4064	B	
14.		07.47	83°22,8'N	19°55,9'E	4064	HF	
		09.14	83°22,6'N	19°57,2'E	4063	IC/GM	
		08.59	83°22,7'N	19°55,6'E	4065		
		09.07	83°22,7'N	19°55,8'E	4063	BO	
		09.14	83°22,7'N	19°55,7'E	4063		
		12.11	83°22,3'N	19°53,6'E	4066	LVS	
		12.15	83°22,3'N	19°53,6'E	4065		
		12.35	83°22,3'N	19°52,7'E	4063	MN 300	500m
		12.48	83°22,3'N	19°52,5'E	4063		
		13.06	83°22,2'N	19°52,3'E	4066	MN 63	500m
383		13.54	83°19,6'N	19°36,4'E	4060	XCP	
384		14.56	83°16,8'N	19°30,1'E	4060	XBT	
385		15.35	83°13,6'N	19°09,5'E	4024	XCP	
386		16.21	83°09,3'N	18°58,6'E	4060	XBT	
387		16.56	83°07,3'N	18°47,2'E	4059	XCP	
388		17.34	83°04,4'N	18°36,3'E	4057	XBT	
389		18.54	83°02,7'N	18°20,6'E	4057	XCP	
390		19.52	82°58,5'N	18°02,7'E	4081	XBT	
391		21.04	82°55,2'N	17°28,2'E	4058	XCP	
392		21.26	82°53,5'N	17°24,4'E	4053	XCP	
393		22.51	82°51,3'N	17°14,7'E	3409		
		00.10	82°51,3'N	17°13,7'E	3314	IC/LA	
		22.18 01.01	82°51,3'N	17°14,3'E	3350	CTD	
15.		01.08	82°51,3'N	17°13,2'E	3319	SD/PN	
		01.28	82°51,3'N	17°13,2'E	3261	MN 63	500m
		01.32	82°50,0'N	17°15,1'E	3240		
		01.38	82°49,9'N	17°14,7'E	3254	BO	
		01.40	82°49,8'N	17°14,5'E	3267		
		01.48	82°49,8'N	17°14,5'E	3260	BO	
		01.50	82°49,6'N	17°13,9'E	3218		
		01.57	82°50,6'N	17°17,7'E	3226	BRO	
		02.01	82°50,5'N	17°17,6'E	3295		
		02.19	82°50,4'N	17°17,3'E	3241	MN 300	500m
		02.24	82°50,3'N	17°17,1'E	3258		
		04.46	82°50,6'N	17°13,6'E	3349	HM	
394		04.56	82°50,6'N	17°13,3'E	3418	XBT	
395		06.21	82°50,7'N	16°45,5'E	3480	XCP	
396		08.36	82°46,5'N	16°04,9'E	1380	XBT	
		08.54	82°47,8'N	16°03,9'E	1376	GKG	0.38/0.38
		09.49	82°47,8'N	16°03,3'E	1377	GKG	0.37/0.37
		10.08	82°47,7'N	16°09,8'E	1378	GM/IC	
		11.11	82°47,8'N	16°02,9'E	1376	KAL6	6.00/0.00
		12.31	82°47,9'N	16°03,0'E	1385	KAL6	4.60/4.18
		13.29	82°48,1'N	16°00,9'E	1388	HF	
		14.26 15.58	82°48,1'N	16°00,2'E	1388	CTD	
		16.53	82°48,1'N	15°59,1'E	1388	KOL12	7.20/7.20
397		17.58	82°48,0'N	15°58,6'E	1328	XCP	
398		18.42	82°44,1'N	15°58,1'E	1328	XBT	
399		19.38	82°39,7'N	15°50,9'E	1377	XCP	
400		20.28	82°37,1'N	15°46,1'E	1464	XBT	

Date 1987	St. No.	Time (UTC)		Latitude	Longitude	Depth (m)	Acti- vity	PD/Scor (m) or n
		Start	End					
Aug.	401	21.24		82°33,2'N	15°52,0'E	1357	XCP	
15.	402	22.28		82°27,4'N	15°49,8'E	1489	XBT	
	403	22.47		82°25,6'N	15°49,0'E	1485	XCP	
	404	23.29		82°22,0'N	15°40,5'E	1656	XBT	
	405	23.51		82°20,2'N	15°41,7'E	1781	XCP	
16.	406	00.37		82°17,0'N	15°40,6'E	2191	XBT	
	407	01.19		82°13,9'N	15°36,7'E	2413	XCP	
	408	01.49		82°11,5'N	15°32,3'E	2494	XBT	
	409	02.17		82°07,7'N	15°33,4'E	2516	XCP	
	410	02.53		82°04,1'N	15°29,0'E	2337	XBT	
	411	03.19		82°01,8'N	15°20,1'E	2147	XCP	
	412	03.54	05.53	82°01,6'N	15°20,1'E	2040	CTD	
		05.58	06.18	82°00,2'N	15°12,2'E	2026	MN 63	500m
		07.09		82°01,9'N	15°10,7'E	2030	SL	
		07.37		82°02,0'N	15°10,4'E	2036	SD/PN	
			07.58	82°01,9'N	15°10,0'E	2031	MN 300	500m
		08.01	08.08	82°01,9'N	15°10,0'E	2030	BO	
		08.10		82°01,9'N	15°09,9'E	2058		
			08.17	82°02,0'N	15°09,8'E	2018	BO	
	413	08.39		82°00,6'N	15°10,4'E	2225	XCP	
	414	09.22		81°58,1'N	15°09,9'E	2365	XBT	
	415	10.05		81°53,2'N	15°13,6'E	2357	XCP	
	416	10.23		81°53,8'N	15°09,6'E	2329	XCP	
	417	11.13		81°49,9'N	15°03,1'E	2260	XBT	
	418	12.05		81°43,9'N	15°00,1'E	2220	XBT	
	419	12.47		81°40,7'N	15°07,3'E	2028	XBT	
	420	13.37		81°38,7'N	15°13,2'E	1946	XBT	
	421	14.23		81°35,5'N	15°20,0'E	2438	XBT	
	422	15.12		81°34,2'N	15°32,7'E	2701	XBT	
	423	20.39	22.38	81°19,6'N	15°20,7'E	2278	CTD	
		22.39		81°19,7'N	15°19,8'E	2268		
			22.47	81°19,8'N	15°19,6'E	2276	BO	
		22.49		81°19,8'N	15°19,6'E	2266		
			22.56	81°19,8'N	15°19,4'E	2276	BO	
		22.58		81°19,8'N	15°19,4'E	2268		
			00.52	81°20,0'N	15°18,7'E	2293	LVS/SD	
		01.00		81°20,0'N	15°19,4'E	2297		
			07.46	81°19,6'N	15°18,2'E	2269	P	
		08.32		81°19,6'N	15°17,9'E	2265	GKG	0.38/C
		08.06		81°19,6'N	15°18,4'E	2267		
			09.06	81°19,5'N	15°17,6'E	2265	FC	
		08.25		81°19,6'N	15°17,9'E	2270		
			09.27	81°19,5'N	15°17,4'E	2262	IC	
		09.48		81°19,5'N	15°17,1'E	2267	HF	
		10.48		81°10,7'N	15°36,8'E	2294	GM	
18.	424	10.36		79°35,5'N	10°28,5'E	29		
			10.52	79°36,0'N	10°26,5'E	36	BO	
		10.58		79°36,2'N	10°26,2'E	38		
			11.12	79°36,5'N	10°24,4'E	43	BO	
19.	425	09.59	11.33	79°06,3'N	02°23,9'W	2574	IC	
20.	426	02.20		79°02,2'N	07°42,9'W	184	Fishing for	
			09.22	79°02,1'N	07°43,9'W	192	mooring 003	

Date 1987	St. No.	Time (UTC)		Latitude	Longitude	Depth (m)	Acti- vity	PD/Score (m) or no
Aug.	427	17.35		78°39,7'N	05°18,7'W	382	SW (Surface)	
21.	428	23.40		78°14,7'N	15°30,0'E		GM Longyearbyen	
22.	429	17.58		78°48,0'N	02°09,0'E	3411	Seabeam-profile	
			22.09	78°48,0'N	05°30,1'E	2528	1-2	
			22.17	78°47,1'N	05°30,5'E	2433	Seabeam-profile	
23.			02.28	78°46,9'N	02°11,3'E	2550	3-4	
			02.37	78°46,0'N	02°11,2'E	2555	Seabeam-profile	
			06.35	78°45,9'N	05°29,4'E	2272	5-6	
			06.46	78°45,1'N	05°30,1'E	2459	Seabeam-profile	
			10.52	78°45,1'N	02°27,6'E	2556	7-8	
			11.03	78°43,9'N	02°26,2'E	2562	Seabeam-profile	
			14.45	78°43,8'N	05°31,5'E	2484	9-10	
			14.56	78°43,0'N	05°30,0'E	2449	Seabeam-profile	
			18.44	78°42,8'N	02°38,6'E	2570	11-12	
			18.53	78°42,0'N	02°37,4'E	2575	Seabeam-profile	
			22.24	78°42,1'N	05°31,0'E	2375	13-14	
			22.34	78°41,0'N	05°30,3'E	2351	Seabeam-profile	
24.			01.45	78°41,1'N	02°55,3'E	2596	15-16	
			01.55	78°40,0'N	02°54,6'E	2588	Seabeam-profile	
			05.07	78°39,8'N	05°29,8'E	2358	17-18	
			05.15	78°39,2'N	05°29,9'E	2367	Seabeam-profile	
			09.06	78°39,0'N	02°23,4'E	2545	19-20	
	430		11.29	78°47,8'N	01°40,0'E	2544		
			13.33	78°48,8'N	01°39,6'E	2552	HM/ SD	
			13.35	78°49,0'N	01°39,5'E	2552		
			14.25	78°47,5'N	01°41,2'E	2555	BO	
			14.29	78°45,8'N	01°46,3'E	2516	CTD	
			16.44	78°45,8'N	01°46,3'E	2555		
			17.43	78°45,1'N	01°46,5'E	2554	HM	
			18.30	78°45,2'N	01°47,4'E	2554	GKG	0.31/0.31
			20.01	78°45,4'N	01°49,5'E	2555	KAL12	6.00/4.95
			21.34	78°45,1'N	01°51,0'E	2557	HF/PN	
			22.57	78°44,8'N	01°52,8'E	2557	KAL6	6.00/5.50
			23.37	78°44,7'N	01°54,3'E	2556		
25.			00.02	78°44,6'N	01°55,3'E	2556	MN	
			01.49	78°43,6'N	01°57,0'E	2554	KOL16	12.0/8.14
			03.02	78°43,0'N	01°57,4'E	2553		
			03.17	78°42,6'N	01°58,5'E	2552	BO	
	431		04.02	78°38,5'N	02°12,8'E	2536	Seabeam-profile	
			08.54	78°38,0'N	05°28,4'E	2367	21-22	
			09.00	78°37,1'N	05°30,3'E	2340	Seabeam-profile	
			12.44	78°37,1'N	02°31,6'E	2553	23-24	
			12.58	78°35,9'N	02°31,3'E	2551	Seabeam-profile	
			16.44	78°35,9'N	05°29,9'E	2255	25-26	
			16.51	78°35,0'N	05°29,8'E	2161	Seabeam-profile	
			21.34	78°34,9'N	02°22,6'E	2502	27-28	
			21.47	78°33,9'N	02°21,1'E	2474	Seabeam-profile	
26.			02.14	78°34,0'N	05°29,6'E	2055	29-30	
			02.22	78°33,1'N	05°29,7'E	1970	Seabeam-profile	
			07.07	78°32,5'N	02°23,8'E	2464	31-32	
			07.14	78°32,1'N	02°20,9'E	2464	Seabeam-profile	
			11.46	78°31,9'N	05°29,0'E	2127	33-34	

Date 1987	St. No.	Time (UTC) Start End	Latitude	Longitude	Depth (m)	Acti- vity	PD/Score (m) or no
August		11.54	78°31,2'N	05°29,7'E	3882	Seabeam-profile	
26.		15.43	78°30,9'N	02°44,2'E	3235	35-36	
		15.55	78°30,1'N	02°45,6'E	2454	Seabeam-profile	
		19.36	78°29,9'N	05°28,9'E	1836	37-38	
		19.43	78°29,1'N	05°29,6'E	1823	Seabeam-profile	
27.		23.53	78°29,0'N	02°34,5'E	2417	39-40	
		00.00	78°28,2'N	02°33,8'E	2302	Seabeam-profile	
		04.27	78°27,8'N	05°30,3'E	1821	41-42	
		04.33	78°27,1'N	05°30,3'E	1802	Seabeam-profile	
		08.09	78°27,0'N	02°57,3'E	2368	43-44	
		08.16	78°26,2'N	02°50,7'E	2342	Seabeam-profile	
		11.52	78°26,0'N	05°27,8'E	1920	45-46	
		11.54	78°26,4'N	05°28,4'E	1856	Seabeam-profile	
		14.53	78°47,8'N	04°09,9'E	2374	46-47	
		14.53	78°47,8'N	04°09,9'E	2374	Seabeam-profile	
		18.07	78°26,4'N	02°51,2'E	2287	47-48	

3.5. LISTE DER ABKÜRZUNGEN, DIE IM TEXT VERWENDET WORDEN SIND

B	-	Boje
BO	-	Bongo-Netz
BRO	-	Biologische Rosette
CTD	-	CTD Rosette
FC	-	Fischnetz
IC	-	Eisbohrung
LA	-	Licht Dämpfung
LVS	-	Großvolumige Wasserproben
MU	-	Multinetz, 63µm/300µm
GKG	-	Großkastengreifer
GPS	-	Globales Positionierungs-System
GM	-	Gravimetrie
HF	-	Wärmeflußmessung
HM	-	Schwermetallschöpfer
KAL	-	Kastenlot; 6, 12 oder 18m
KOL	-	Kolbenlot
PN	-	Planktonnetz
P	-	Tiefwasser-Pumpen
SD	-	Secchi-Scheibe
SL	-	Schwerelot
SW	-	Schnee und Wasser, Proben vom Packeis
WS	-	Wasserschöpfer
XBT	-	Einweg-Bathythermograph
XCP	-	Einweg-Strömungsmesser
PD	-	Eindringtiefe

3.6. Working Groups

Bathymetry:	Heidland, K.	(AWI)		
Meteorology:	Richter, B.	(SWA)		
	Sonnabend, H.	(SWA)		
Sea Ice:	Gascard, J.-C.	(LODYC)		
	Krishfield, R.	(WHOI)		
	Mudie, P.	(AGC)		
	Pfirman, S.	(GIK)		
	Richter, B.	(SWA)		
	Sonnabend, H.	(SWA)		
	Stute, U.	(RWTH)		
	Thomsen, L.	(AWI)		
	Wollenburg, I.	(GIK)		
Oceanography:	Anderson, L.	(UGÖ)	Masten, D.	(SIO)
	Bönisch, G.	(IUPH)	McKeown, P.	(UW)
	Buesseler, K.	(WHOI)	Muus, D.	(SIO)
	Gascard, J.-C.	(LODYC)	Osborne, J.	(SIO)
	Hirschberg, D.	(NYSB)	Pfirman, S.	(GIK)
	Jones, E. P.	(AGC)	Richez, C.	(LODYC)
	Koltermann, K.P.	(DHI)	Rodriguez, J.	(PHYBE)
	Krishfield, R.	(WHOI)	Schlosser, P.	(IUPH)
	Kromer, B.	(IUPH)	Swift, J.	(SIO)
	Krysell, M.	(UGÖ)	Wallace, D.	(AGC)
	Lütje, H.	(DHI)	Westerlund, S.	(UGÖ)
	Marian, P.	(IUPH)	Zemlyak, F.	(AGC)
Biology & Paleontology:	Altenbach, A.	(GIK)		
	Baumann, M.	(RWTH)		
	Bieser, J.	(UTÜ)		
	Carstens, J.	(FG/UB)		
	Horwege, S.	(GIK)		
	Matthiessen, J.	(GIK)		
	Mudie, P.	(AGC)		
	Mumm, N.	(IPÖ)		
	Stute, U.	(RWTH)		
	Thomsen, L.	(AWI)		
Marine Biology & Geophysics:	Baumann, M.	(RWTH)	Sobiesiak, M.	(FG/UB)
	Bleil, U.	(FG/UB)	Spielhagen, R.	(GIK)
	Bohrmann, H.	(GIK)	Steen, E.	(GIK)
	Botz, R.	(GIK)	Sundvor, E.	(JSS)
	Carstens, J.	(FG/UB)	Thiede, J.	(GIK)
	Haake, F.-W.	(GIK)	Torp, J.-E.	(ISS)
	Horwege, S.	(GIK)	Vassmyr, S.	(IBG)
	Koerner, T.	(IFMK)	Weber, W.	(UB)
	Kubisch, M.	(GIK)	Wollenburg, I.	(GIK)
	Matthiessen, J.	(GIK)		
	Mudie, P.	(AGC)	Altenbach, A.	(GIK)
	Mühlhan, N.	(GIK)	Bieser, J.	(UTÜ)
	Nowaczyk, N.	(FG/UB)	Heidland, K.	(AWI)
	Pagels, U.	(GIK)	Krishfield, R.	(WHOI)
			Pfirman, S.	(GIK)

3.7. PROGRAMM DER "POLAR UNIVERSITÄT"

Während der Expedition ARK IV/3 wurden auf der POLARSTERN Vertragszyklen im Rahmen einer speziell dafür gegründeten POLAR UNIVERSITÄT abgehalten. Die interdisziplinäre und internationale Forschergruppe umfaßte so viele Disziplinen und wissenschaftliche Fachrichtungen, daß die arktischen Probleme aus vielen Perspektiven beleuchtet werden konnten.

Die POLAR UNIVERSITÄT umfaßte Vortragsserien auf Deutsch und auf Englisch, um allen Teilnehmern dieser Ausfahrt Gelegenheit zur Teilnahme und zur Weiterbildung zu geben. Folgende Themen wurden während der Veranstaltung der POLAR UNIVERSITÄT angeboten:

POLAR UNIVERSITÄT ARK IV/3 POLARSTERN JULI-SEPTEMBER 1987

Übersichtsvorträge auf Deutsch zur Erläuterung des wissenschaftlichen Programmes der Expedition für die Damen und Herren der Besatzung der POLARSTERN, sowie für die wissenschaftlichen Fahrtteilnehmer. Alle Vorträge mit Lichtbildern oder Demonstrationen.

BLEIL, ULRICH (FACHBEREICH GEOWISSENSCHAFTEN, UNIVERSITÄT BREMEN)
Warum der magnetische Kompaß in der Arktis nicht immer funktioniert

KOLTERMANN, PETER (DEUTSCHES HYDROGRAPHISCHES INSTITUT)
Die Ozeanographie der polaren Tiefseebecken: Kühlhäuser des Weltmeeres

THIEDE, JÖRN (GEOLOGISCH-PALÄONTOLOGISCHES INSTITUT UND MUSEUM,
UNIVERSITÄT KIEL)
Das Nordpolarmeer: Geologie der letzten unbekanntten Großlandschaft der Erde

ZEMLYAK, FRANK, P. JONES, D. WALLACE, u. a.
(BEDFORD INSTITUTE OF OCEANOGRAPHY)
Eine andere Arktische Ozeanographie

ALLE SENIORWISSENSCHAFTLER DER AUSFAHRT
Die wichtigsten wissenschaftlichen Resultate der Expedition ARK IV/3 (gegen Ende der Ausfahrt auf dem Wege nach Hamburg)

POLAR UNIVERSITY ARK IV/3 POLARSTERN JULY-SEPTEMBER 1987

ANDERSON, LEIF (DEPARTMENT OF ANALYTICAL AND MARINE CHEMISTRY, CTH/UG-
GÖTEBORG)
The chemistry of cold, high salinity bottom water of the Arctic Ocean Shelf (sediment water interactions, LANCE 1986 Cruise, Canadian Ice Island)

BLEIL, U. (FACHBEREICH GEOWISSENSCHAFTEN, UNIVERSITÄT BREMEN)
Paleomagnetism of high latitude ocean sediment cores

BUESSELER, KEN (WOODS HOLE OCEANOGRAPHIC INSTITUTION)
Particle reactive and soluble artificial radionuclides in Arctic Seas

CARSTENS, JÖRN (FACHBEREICH GEOWISSENSCHAFTEN, UNIVERSITÄT BREMEN)

Planktonic foraminifers. Standing stocks and seasonal fluxes in the Norwegian Greenland Sea

GASCARD, J. C. (LABORATOIRE D' OCEANOGRAPHIE DYNAMIQUE ET DE CLIMATOLOGIE, UNIVERSITE PIERRE ET MARIE CURIE)

A diagnostic study of large scale and mesoscale circulation in Fram Strait from Mizex 83 and 84 Lagrangian Observations

HIRSCHBERG, D. J. (MARINE SCIENCE RESEARCH CENTER, STATE UNIVERSITY OF NEW YORK)

The isotope distributions in Northwest Atlantic Ocean Waters

JONES, E. P., WALLACE, D. (BEDFORD INSTITUTE OF OCEANOGRAPHY), ANDERSON, LEIF (DEPARTMENT OF ANALYTICAL AND MARINE CHEMISTRY, CTH/UG-GÖTEBORG) The Arctic Ocean halocline (results from CESAR Ice Camp, Canadian Ice Island, MISEX 1984, CO₂ atmosphere-ocean exchange, freons in Arctic Ocean - residence times of water masses)

KOLTERMANN, PETER (DEUTSCHES HYDROGRAPHISCHES INSTITUT)

The deep Arctic outflow and its fate in the Greenland Sea

MUDIE, PETA (GEOLOGICAL SURVEY OF CANADA, BEDFORD INSTITUTE OF OCEANOGRAPHY)

Lithostratigraphy, Micropaleontology and isotope stratigraphy of Alpha Ridge cores, 85 N, 110 W, Central Arctic Ocean

RICHTER, B. (SEEWETTERAMT HAMBURG)

Weather and climate of the Arctic

SCHLOSSER, P. (INSTITUT FÜR UMWELTPHYSIK, UNIVERSITÄT HEIDELBERG)

A tracer study of the deep water renewal in the European Polar Seas

SUNDEVOR, EIRIK (JORDSKJELVSTASJONEN, UNIVERSITETET I BERGEN)

Heat in the Arctic

SWIFT, JIM (SCRIPPS INSTITUTION OF OCEANOGRAPHY AND COLLEGE OF OCEAN AND FISHERIES /UNIVERSITY OF WASHINGTON)

Water masses and circulation of the Arctic Mediterranean Seas

THIEDE, J. (GEOLOGISCH-PALÄONTOLOGISCHES INSTITUT UND MUSEUM, UNIVERSITÄT KIEL)

Paleoceanography of the Eastern Arctic

WESTERLUND, S. (DEPARTMENT OF ANALYTICAL AND MARINE CHEMISTRY CTH/UG-GÖTEBORG)

Trace metals in sea water

Participating Institutions

Adress	Participants	Leg
Bundesrepublik Deutschland		
AWI Alfred-Wegener-Institut für Polar- und Meeresforschung Columbusstraße D-2850 Bremerhaven	20	1, 2, 3
BAH Biologische Anstalt Helgoland Außenstelle List/Sylt 2282 List/Sylt	1	2
BNI Bernhardt-Nocht-Institut für Schiffs- und Tropenkrankheiten Bernhardt-Nocht-Straße 74 2000 Hamburg	2	2
DFVLR Deutsche Forschungs- und Versuchsanstalt für Luft- und Raumfahrt Postfach 8031 Weßling/Oberpfaffenhofen	1	1
DHI Deutsches Hydrographisches Institut Bernhardt-Nocht-Straße 74 2000 Hamburg	3	2, 3
FG/UB Fachbereich 5 - Geowissenschaften Universität Bremen Postfach 33 04 40 2800 Bremen 33	7	3
FIS Forschungsinstitut Senckenberg Senckenberganlage Postfach 6000 Frankfurt	1	2
GIK Geologisch-Paläontologisches Institut und Museum Christian-Albrechts-Universität Olshausenstraße 40 2300 Kiel 40	14	3
HSW Helicopter Service Wasserthal GmbH Kätnerweg 43 2000 Hamburg 65	5	1,2,3
IfMH Institut für Meereskunde Heimhuder Straße 71 2000 Hamburg	4	2

IfMK	Institut für Meereskunde Düsternbrooker Weg 20 2300 Kiel 1	5	1,2
IPO	Institut für Polarökologie der CAU Physikzentrum Leibnizstraße 11-19 2300 Kiel	1	3
IUPH	Institut für Umweltphysik der Universität Heidelberg Im Neuenheimer Feld 366 6900 Heidelberg	3	3
MPIL	Max-Planck-Institut für Limnologie Postfach 2320 Plön	1	2
RWTH	Rheinisch-Westfälische Technische Hochschule Worringer Weg 5100 Aachen	6	1,2,3
SPUM	Sektion Physik der Universität München Am Coulombwall 1 8040 Garching	1	1
SWA	Seewetteramt Bernhard-Nocht-Straße 76 2000 Hamburg	5	1,2,3
IOCB	Institut für Organische Chemie und Biochemie Martin-Luther-King-Platz 6 2000 Hamburg 13	2	1
UTÜ	Universität Tübingen Geologisch-Paläontologisches Institut Sigwartstraße 10 7400 Tübingen	1	3
Dänemark			
RNL	Risø National Laboratory Postbox 49 DK-4000 Roskilde	1	2
Finnland			
UHE	University of Helsinki Department of Geophysics Fabianinkatu 24 A SF-00100 Helsinki 10	1	1

Frankreich

LODYC Laboratoire d'Océanographie
Dynamique et de Climatologie
Tour 14. 2e Floor
Université Pierre et Marie Curie
4 Place Jussieu
F-75252 Paris Cedex 05

2 3

Großbritannien

WOCE International Planning Office
Institute of Oceanographic Sciences
Wormley, Godalming Surrey,
UK-GU8 SUBV

1 3

Kanada

AES Atmospheric Environmental
Service, Ice Branch
365 Laurier Av.-W.
Ottawa, Ontario K1A 0H3

2 1,2

ACC Atlantic Geoscience Center
Department of Fisheries and Oceans
Bedford Institute of Oceanography
Box 10 06
Dartmouth, Nova Scotia B2Y 4A2

4 3

YU York University
Centre for Research
in Experimental Space Science
47700 Keelestreet,
North York, ONT. M3J 1P3

3 1,2

Norwegen

IBG Institutt for biologi og geologi
Universitetet i Tromsø
Postboks 3085
N-9001 Tromsø, Norway

1 3

JSS Jordskjelvstasjonen
Reasfagbygg
Allegate 41
N-5014 Bergen-Universitetet

3 2

NPI Norsk Polar Institutt
Postboks 158
N-1330 Oslo Lufthavn, Norway

3 2

Schweden

UCÖ Department of analytical and
Marine Chemistry CTH/GU
S-412 96 Göteborg, Sweden

3 3

Sowjetunion

ITE	Institute of Thermophysics and Electrophysics Paldiski Rd. 1 200031 Tallinn Estonia USSR	3	1,2
-----	---	---	-----

Vereinigte Staaten von Amerika

APL/UW	Applied Physics Laboratory University of Washington Seattle, Washington 98195	1	3
CRREL	U.S. Army Cole Regions Research and Engineering Laboratory 72, Lymne Rd. Hannover, N.H. 03755 USA	1	3
IOEG	Institute of Ecology, University of Georgia Athens, Georgia 30602	1	1
LDGO	Lamont-Doherty Geological Observatory Palisades, New York 10964	1	3
PMEL	Noaa Pacific Marine Environmental Laboratory	2	2
NCAR	National Center for Atmospheric Research P. O. B. 3000 Boulder, Colorado 80 307	1	2
NYSB	Marine Science Research Center State University of New York Stony Brook N.Y. 11794 USA	1	3
SIO	Scripps Institute of Oceanography Oceanographic Data Facility A-014, La Jolla, CA 92093	10	1,2,3
TCES	Tiburon Center for Environmental Studies P. O. B. 855 Tiburon CA. 94920	1	1,2
UOT	University of Tennessee Graduate Program in Ecology Knoxville, TN 37996	6	1,2
WHOI	Woods Hole Oceanographic Institution Woods Hole Massachusetts 02543	2	3

Participants

ARK IV/1

<u>Name</u>	<u>Institute</u>
Asmus, K.	AWS/YU
Baumann, M.	RWTH
Barthel, K.-G.	IfMK
Bohrer, R. N.	TCES
Budéus, G.	AWI
Büns, I.	IOCB
Creasman, E. A.	UOT
Culver, M. E.	UOT
Douglas, D. J.	IOEG
Edwards, G. D.	SIO
El Naggar, S.	AWI
Folkerts, E.	HSW
Garrity, C.	YU
Gassel, M. F.	UOT
Gradinger, R.	IfMK
Gunkel, J.	IfMK
Hadikusumah	AWI
Heidland, K.	AWI
Hillebrandt, O.	HSW
Hirche, H.-J.	AWI
Kahru, M.	ITE
Kattner, G.	AWI
Keene, N. K.	UOT
Köhler, H.	SWA
König, C. W.	DFVLR
Krause, G.	AWI
Krämer, M.	RWTH
Kurbjeweit, F.	IfMK
Launiainen, J.	UHE
Lenz, J.	IfMK
Lopez, L. T.	SIO
Nomann, S.	ITE
Plugge, R.	AWI
Ramseier, R.	YU
Röd, E.	SWA
Rothe, K. W.	SPUM
Sildam, J.	ITE
Schneider, W.	AWI
Schostak, J.	SWA
Schütt, M.	IOCB
Steinbrecht, W.	SPUM
Stute, U.	RWTH
Trees, C.C.D.	SIO
Urban, T.	RWTH
Walter, M.	AWI

ARK IV/2

Aagaard, K.	PMEL
Asmus, K.	AES
Barthe., K.-G.	IfMK
Bohrer, R. NN.	TCES
Bos, D.	SIO
Cameron, M.	YU
Creasman, L.	AES
Dahlgaard, H.	RNL
Darnell, C.	PMEL
Elbrächter, M.	BAH
El-Naggar, S.	AWI
Emery, B.	NCAR
Erlingsson, B.	NPI
Fahrbach, E.	AWI
Field, T.	SIO
Garrity, C.	YU
Gassel, M.	AES
Grawunder, D.	IfMK
Gradinger, R.	IfMK
Gunkel, J.	IfMK
Haass, R.	FSF
Hermann, R.	BNI
Hillebrandt, M.	HSW
Hirche, H.-J.	AWI
James, M.	SMBA
Kahru, M.	ITE
Kattner, G.	AWI
Keene, N.	UOT
Knickmeier, K.	AWI
Köhler, H.	SWA
Krämer, Maria	RWTH
Kurbjeweit, F.	IfMK
Low, A.	BNI
Meincke, J.	IfMH
Nomman, S.	ITE
Olbers, D.	AWI
Radlinger, W.	HSW
Reincke-Kunze, C.	Journalistin
Roed, E.	SWA
Rohardt, G.	AWI
Rudels, B.	NPI
Rüger, H.-J.	AWI
Segschneider, J.	IfMH
Sildan, J.	ITE
Steinbrecht, W.	AWI
Steinmetz, R.	AWI
Stute, U.	RWTH
Summa, C.	AWI
Tan, L.	AWI
Tillmann, U.	RWTH
Thomsen, L.	AWI
Vinje, R.	NPI
Weide, G.	AWI
Wohlert, K.	AWI
Wüllner, H.	IfMH

ARK IV/3

Altenbach, A.	GIK
Anderson, L.	UGÖ
Baumann, M.	RWTH
Baumann, M.	FG/UB
Beiser, J.	UTÜ
Bleil, U.	FG/UB
Bohrmann, H.	GIK
Bönisch, G.	IUPH
Botz, R.	GIK
Buesseler, K.	WHOI
Carstens, J.	FG/UB
Gascard,, J. C.	LODYC
Haake, F.-W.	GIK
Heidland, K.	AWI
Hirschberg, D. S.	NYSB
Horwege, S.	GIK
Jones, E. P.	AGC
Koltermann, K. P.	DHI
Krishfield, R.	WHOI
Kromer, B.	UIPH
Krysell, M.	UGÖ
Kubisch, M.	GIK
Lundström, V.	HSW
Mahler, G.	HSW
Masten, D.	SIO
Mathiessen, J.	GIK
McKeown, P.	UW
Mienert, J.	FG/UB
Mudie, P.	AGC
Mumm, N.	IPÖ
Mühlhan, N.	GIK
Muus, D.	SIO
Nowaczyk, N.	FG/UB
Osborne, J.	SIO
Pagels, U.	GIK
Pfirman, S.	GIK
Richter, B.	SWA
Schlosser, P.	IUPH
Sobiesiak, M.	FG/UB
Sonnabend, H.	SWA
Spielhagen, T.	GIK
Steen, E.	GIK
Stute, U.	RWTH
Sundvor, E.	JSS
Swift, J.	SIO
Thiede, J.	GIK
Thomsen, L.	AWI
Torp, J.	
Vassmyr, S.	
Wallace, D.	AGC
Weber, W.	UB
Westerlund, S.	UGÖ
Wollenburg, I.	GIK
Zemlyak, F.	AGC

SHIP'S CREW

ARK VI/1

Name des Schiffes: "POLARSTERN"

<u>Lfd.Nr.</u>	<u>NAME, VORNAME</u>	<u>DIENSTGRAD</u>
01	Jonas, Heinz	Kapitän
02	Zehler, Peter	1.Naut.Offizier
03	Stehr, Jan	2.Naut.Offizier
04	Korn, Lorenz	2.Naut.Offizier
05	Wiese, Franz	Funkoffizier
06	Raeder, Fritz	Funkoffizier
07	Dr. Heine, Bernhard	Schiffsarzt
08	Walter, Jürgen	Leiter d.Masch.- Anlage
09	Gröhn, Heinrich	1.Techn.Offizier
10	Hedden, Christian	2.Techn.Offizier
11	Simon, Wolfgang	2.Techn.Offizier
12	Erdmann, Reinhard	Elektroniker
13	Nitsche, Peter	Elektroniker
14	Husmann, Claus	Elektroniker
15	Weitkamp, Bernhard	Elektroniker
16	Hoops, Klaus-Jürgen	Elektroniker
17	Schwarz, Reinhard	Bootsmann
18	Marowski, Klaus	Zimmermann
19	Schierl, Franz	Lagerhalter
20	Sobral Sobral, Manuel	FA/Deck
21	Meis Torres, Manuel	FA/Deck
22	Meis Torres, Alberto	FA/Deck
23	Novo Loveira, Jose	FA/Deck
24	Prol Otero, Antonio	FA/Deck
25	Pereira Portela, Bernardo	FA/Deck
26	Wittfoth, Willi	FA/Masch.
27	Ulbricht, Wolfgang	FA/Masch.
28	Carstens, Erwin	FA/Masch.
29	Dufner, Gustav	FA/Masch.
30	Husung, Udo	FA/Masch.
31	Klasen, Heinz Dieter	Koch
32	Kubica, Egon	Kochsmaat
33	Bender, Harry	Kochsmaat
34	Scheel, Gerhard	1.Steward
35	Friedrich, Sylvia	Stewardess
36	Bartzen, Bettina	Stew./Krank.
37	Gollmann, Elfriede	Stewardeß
38	Diekamp, Jutta	Stewardeß
39	Fang, Shing-Yi	2. Steward
40	Chiang, Yu	2. Steward
41	Guo, Shin-Jye	Wäscher

ARK VI/3

Name des Schiffes: "POLARSTERN"

<u>Lfd.Nr.</u>	<u>NAME, VORNAME</u>	<u>DIENSTGRAD</u>
01	Jonas, Heinz	Kapitän
02	Götting, Hans	1. Offizier
03	Allers, Claus	1. Offizier
04	Oelkers, Ernst-August	1. Offizier
05	Varding, Ingo	2. Offizier
06	Geiger, Horst	Funkoffizier
07	Müller, Eberhard	Funkoffizier
08	Heine, Bernhard	Arzt
09	Müller, Klaus	Chefingenieur
10	Gröhn, Heinrich	1. Ingenieur
11	Delff, Wolfgang	2. Ingenieur
12	Erreth, Gyula	2. Ingenieur
13	Schuster, Georg	Elektriker
14	Ohlandt, Heinz	Elektriker
15	Elvers, Heinrich	Elektroniker
16	Thonhauser, Werner	Elektroniker
17	Schier, Rolf	Elektroniker
18	Woltin, Karl	Bootsmann
19	Kasubeck, Peter	Zimmermann
20	Reimann, Siegmar	Lagerhalter
21	Abreu Dios, José	Matrose
22	Iglesias Bermudez, Albino	Matrose
23	Suarez Paisal, Antonio	Matrose
24	Soage Curra, José	Matrose
25	Pousada Martinez, Saturino	Matrose
26	Otero Rodriguez, Evaristo	Matrose
27	Sobral Sobral, Manuel	Matrose
28	Novo Loveira, José	Matrose
29	Jordan, Gerd	Masch.-Wart
30	Fritz, Günter	Masch.-Wart
31	Schütt, Klaus	Masch.-Wart
32	Rottstock, Ernst	Masch.-Wart
33	Carstens, Erwin	Masch.-Wart
34	Puberl, Waldemar	Koch
35	Wübber, Heinz	Kochsm.
36	Unger, Jan	Kochsm.
37	Peschke, Dieter	1. Steward
38	Hoppe, Martha	Stewardess
39	Hopp, Agnes	Stewardess
40	Feigler, Margarethe	Stewardess
41	Lieboner, Roswitha	Stewardess
42	Fang, Shing-Yi	2. Steward
43	Chiu, Chung-Sheng	2. Steward
44	Guo, Shin-Jye	Wäscher
45	Thonhauser, Rotraud	zusätzl.Hilfskraft
46	Geiger, Sven	zusätzl.Hilfskraft

ARK VI/2

Name des Schiffes: "POLARSTERN"

<u>Lfd.Nr.</u>	<u>NAME, VORNAME</u>	<u>DIENSTGRAD</u>
01	Jonas, Heinz	Kapitän
02	Zehler, Peter	1.Naut.Offizier
03	Stehr, Jan	2.Naut.Offizier
04	Korn, Lorenz	2.Naut.Offizier
05	Geiger, Horst	Funkoffizier
06	Raeder, Fritz	Funkoffizier
07	Dr. Heine, Bernhard	Schiffsarzt
08	Briedenhahn, Claus	Leiter der Masch.-Anlage
09	Gröhn, Heinrich	1. Techn.Offizier
10	Figuth, Hans-Joachim	2. Techn.Offizier
11	Simon, Wolfgang	2. Techn.Offizier
12	Ohland, Heinz	Elektroniker
13	Husmann, Claus	Elektroniker
14	Weitkamp, Bernhard	Elektroniker
15	Hoops, Klaus-Jürgen	Elektroniker
16	Kassubeck, Peter	Zimmermann
17	Reimann, Siegmart	Lagerhalter
18	Abreu Dios, Jose	FA/Deck
20	Iglesias Bermudez, Balbino	FA/Deck
21	Suarez Paisal, Antonio	FA/Deck
22	Soage Curra, Jose	FA/Deck
23	Pousada Martinez, Saturnino	FA/Deck
24	Otero Rodriguez, Evaristo	FA/Deck
25	Jordan, Gerd	FA/Masch.
26	Fritz, Günter	FA/Masch.
27	Schütt, Klaus	FA/Masch.
28	Rottstock, Ernst	FA/Masch.
29	Fabian, Heinz	FA/Masch.
30	Puberl, Waldemar1	Koch
31	Kubicka, Egon	Kochsmaat
32	Unger, Jan	Kochsmaat
33	Peschke, Dieter	1. Steward
34	Friedrich, Sylvia	Allein-Steward.
35	Hopp, Agnes	A-Stewardess
36	Feigler, Margarethe	A-Stewardess
37	Liebner, Roswitha	Stew./Krank.
38	Fang, Shing-Yi	2. Steward
39	Chiang, Yu	2. Steward
40	Guo, Shin-Jye	Wäscher