

2.6 Ecophysiology of Carbon Assimilation and Nitrogen Fixation in a Sub-Antarctic Lichen

By Valdon R. Smith*

Summary: An account is given of the influence of thallus moisture content, temperature, light and pretreatment with glucose or phosphate-P on net carbon dioxide assimilation rate (NAR) and nitrogen fixation (acetylene reduction: AR) in an undescribed *Peltigera* species on Marion Island (47°S, 38°E). Field moisture contents of the younger portions of the thallus were between 170 and 350% on a dry weight basis, and maximum NAR occurred between 250 and 350%. In experiments on the influence of temperature and light on NAR, thallus moisture content was adjusted to give maximum NAR and the vapour pressure deficit over the lichen held at <0.1 kPa. Optimum temperature for NAR depended on photosynthetic photon flux density (PPFD) but was from 8 to 18° C at PPFD's between 200 and 800 $\mu\text{mol m}^{-2} \text{s}^{-1}$. Lowest temperature for a positive NAR was between -2 and -3° C and rates increased markedly with temperature, so that at 5° C they were from 60 to 80% of the maximum. Compensating PPFD increased as temperature increased above -1° C. Saturating PPFD for NAR also depended on temperature but was mostly between 400 and 600 $\mu\text{mol m}^{-2} \text{s}^{-1}$, and for temperatures above c. 14° C photoinhibition occurred at higher light levels. Field moisture contents of the thalli rarely reached optimal levels for AR, which increased up to moisture contents of about 380% to 460% and declined sharply at supra-optimal levels. AR responded markedly to increasing light at low levels and was 90% light-saturated at a PPFD of c. 40 $\mu\text{mol m}^{-2} \text{s}^{-1}$. Appreciable rates of AR occurred in the dark and, as temperature increased, they became a smaller fraction of the rates in the light. Optimum temperature for both light and dark AR was 22 to 23° C and Q_{10} values between 0 and 20° C were 3.3 to 3.6 in the light and 2.1 to 2.2 in the dark. Detectable AR occurred at -2° C but not at -4.5° C. AR rates in the dark declined with increasing length of the dark period and the rate of decline increased with temperature. Glucose pretreatment enhanced AR rates and ameliorated their decline during the dark period. There is an almost total lack of microclimatological information for the island but it would appear that the lichen is well adapted to the macroclimate, which is dominated by moderately low temperatures, low irradiance levels and high precipitation.

Zusammenfassung: Für eine bisher unbeschriebene *Peltigera*-Art von Marion Island (47°S, 38°E) werden die Einflüsse von Thalluswassergehalt, Temperatur, Licht und Vorbehandlung mit Glukose oder Phosphat-P auf die CO_2 -Nettoassimilation (NAR) und die Stickstofffixierung (Acetylen-Reduktion, AR) dargelegt. Unter Feldbedingungen erreichten junge Thallusabschnitte Wassergehalte von 170—350% des Trockengewichts, wobei die NAR bei 250—350% maximal war. Bei der Ermittlung der Licht- und Temperaturabhängigkeit der Nettophotosynthese wurde der Wassergehalt bei einem Wasserpotential der Luft von <0.1 kPa optimal gehalten. Die Temperaturoptima der NAR variierten mit der Lichtintensität und lagen zwischen 200 und 800 $\mu\text{mol m}^{-2} \text{s}^{-1}$ bei 8—18° C. Die NAR war bei -2 bis -3° C minimal und erreichte bei 5° C bereits 60—80% des jeweiligen Maximums. Der Lichtkompensationspunkt stieg ab -1° C mit steigender Temperatur an. Lichtsättigung ergab sich bei 300—600 $\mu\text{mol m}^{-2} \text{s}^{-1}$ PAR. Bei Temperaturen über 14° C und höheren Lichtintensitäten trat Lichthemmung ein. Unter natürlichen Bedingungen waren die Wassergehalte der Thalli selten optimal für die AR (Optimum bei 380—460% des Trockengewichts). Bei suboptimalen Wassergehalten fiel die AR rapide auf niedrige Werte ab. Nach einem Anstieg mit der Lichtintensität bis 40 $\mu\text{mol m}^{-2} \text{s}^{-1}$ erreichte die AR Lichtsättigung. Im Dunkeln stieg die AR mit zunehmenden Temperaturen an, doch war sie immer nur ein Bruchteil der Rate bei Licht. Die Optimaltemperatur der AR bei Licht und Dunkelheit lag zwischen 22 und 23° C, die Q_{10} -Werte erreichten 3,3—3,6 (bei 0—20° C) im Licht und 2,1—2,2 im Dunkeln. AR war bei -2° C noch, bei -4,5° C nicht mehr meßbar, mit zunehmender Länge der Dunkelperiode und steigender Temperatur fiel die AR ab. Glukosegaben konnten die Raten erhöhen und den Dunkeldefekt kompensieren. Es wird angenommen, daß die Flechte an ihr Standortklima (mäßig niedrige Temperaturen, geringe Strahlung und hohe Niederschläge) gut angepaßt ist, doch liegen keine Mikroklimamessungen von Marion Island vor.

1. INTRODUCTION

The terrestrial sub-Antarctic region (sensu LEWIS SMITH 1984) comprises six islands or island groups and possesses in excess of 300 lichen species. The lichen flora of Marion Island (47°S, 38°E) has been inadequately studied but consists of approximately 140 species (A. HENSSEN pers. com.). Lichens, mostly crustose epilithic forms, occur in almost all of the 41 plant communities described for the island by GREMMEN (1981) but rarely as a conspicuous component of the vegetation. Few lichens occur in wet communities making up the bog/mire-grassland complex. One of these, previously identified as *Peltigera canina* (L.) Willd. (LINDSAY 1976) is listed by GREMMEN (1981) as being more common in drier communities, especially fernbrakes which are dominated by the fern *Blechnum penna-marina* (Poir.) Kuhn and occur mainly on slopes. The identity of this lichen is now in doubt and it is apparently an undescribed species (LEWIS SMITH pers. com.). It appears to be increasing in abundance and distribution on the island and is common in some of the wetter fernbrakes and also in ecotones between fernbrakes and mire-grasslands. It also occurs in flat, bryophyte-dominated bogs near the shore. It has a typical *Peltigera*-like foliose growth form with thallus branches up to 6 cm, more usually 2 to 4 cm long. The older portions of the thallus are light grey to grey-green, in close contact with the peat and pieces of plant litter, and generally show various stages of senescence and decomposition. The younger parts forming the lobes or branches are generally held at a slight angle to the horizontal, although in very wet bogs and in dense fern mats they are often vertical. The top surface of the branches are light grey-green to dark green with brown tips. The undersurface is white and often connected to the underlying peat or water-saturated litter by a poorly-developed tomentum.

* Prof. Dr. Valdon R. Smith, Department of Botany, The University of the Orange Free State, P. O. Box 339, Bloemfontein 9301, South Africa.

Mire-grassland and fernbrake communities on the island exhibit substantial annual primary production (SMITH 1987a, b) and a current objective of the biological research programme on the island is to examine the ecophysiological responses to factors which influence the primary production of the various plant species in these communities. Photosynthetic responses to light and temperature of the dominant vascular species, *Agrostis magellanica*, in the mire-grasslands have been described by PAMMENTER et al. (1986) and we are currently examining the influences of light, temperature, moisture and nutrient levels on photosynthesis and respiration in a variety of bryophytes. This paper presents the photosynthetic and nitrogen fixation (acetylene reduction) characteristics of the, as yet unidentified, *Peltigera* species. It represents the first ecophysiological study of a lichen from the sub-Antarctic.

2. MATERIALS AND METHODS

2.1 Sample Collection and Treatment

Lichens were collected from a wet site close to the laboratory immediately prior to use. Healthy-looking thalli were selected, cleaned of adhering debris and peat in a gentle stream of water and the older, basal parts excised. The thallus portions were patted lightly with tissue paper to remove excess water and used for studies of the influence of temperature and light (photosynthetic photon flux density; PPF) on net CO₂ assimilation rate (NAR) or acetylene reduction (AR). In studies of the influence of thallus moisture content on NAR or AR the cleaned thalli were soaked in tap water (ionic concentrations and concentration ratios very similar to those in rainwater and peatwater on the island) for 1 to 2 h at temperatures between 6 and 15° C and PPF's between 200 and 500 $\mu\text{mol m}^{-2} \text{s}^{-1}$. In studies on the influence of glucose on AR, thalli were soaked in either water or 1% glucose in water for 24 h under the same light and temperature conditions given above.

2.2 CO₂ Assimilation Rate

NAR was determined with an Analytical Development Company (ADC; Hoddesdon, England) type 225 Mark III infrared gas analyser (IRGA) operating in the differential mode. Open flow systems were used (Fig. 1), which differed in configuration according to the purpose of the experiment.

To investigate the influence of thallus moisture content on NAR (Fig. 1a), air from outside the laboratory was pumped in excess into a 25 l mixing reservoir. A smaller stream ($400 \text{ cm}^3 \text{ min}^{-1}$) was pumped from the reservoir via a rotameter and two-way stopcock to either a drying column (magnesium perchlorate) or a humidifier. The latter consisted of a 300 mm long, water-jacketed glass tube (7 mm i. d.). The inside of the tube was lined with wet filter paper and the surrounding water jacket connected to a controlled-temperature water circulator. From the humidifier or drying column the airstream went to a lichen cuvette which was a 37 mm i. d.; 150 mm long glass tube with a narrower (7 mm i. d., 300 mm long) glass tube connected to one end. Both tubes were water-jacketed and air passed through the thinner tube before reaching the lichen which was contained in the larger one. A spherical manifold of fine orifices between the tubes ensured even airflow in the large one. Fine thermocouples in various parts of the two tubes showed that the temperature of the airstream had stabilized before reaching the lichen. From the cuvette the air went through a drying column to the analysis cell of the IRGA. A second airstream was pumped ($400 \text{ cm}^3 \text{ min}^{-1}$) from the mixing reservoir through a rotameter, a buffer volume approximately equal to the combined volume of the cuvette and humidifier, and a drying column to the reference cell of the IRGA.

A saturated lichen thallus was lightly blotted with tissue paper to remove excess surface water and placed horizontally on a saturated wad of tissue paper in a plastic weighing boat. The paper wad was manipulated to maximize contact between it and the undersurface of the thallus. The weighing boat was placed in the cuvette and subjected (from above) to a constant PPF between 500 and 600 $\mu\text{mol m}^{-2} \text{s}^{-1}$, supplied by a 400 watt SON high pressure sodium vapour discharge lamp (S. A. Philips, Newville, South Africa) and measured with a LI 190S quantum sensor (Li-Cor Inc., Nebraska). Air temperature in the cuvette was maintained at 15° C. Because it was difficult to maintain a thermocouple in or against the thallus (which had to be repeatedly removed from the cuvette for weighing), thallus temperature was not monitored during the moisture content/NAR trials but was probably between 16 and 17° C.

The analysis air stream was routed through the humidifier, the temperature of which was adjusted to give a vapour pressure deficit of < 0.1 kPa in the cuvette. When the CO₂ uptake rate stabilized (generally within 30 minutes)

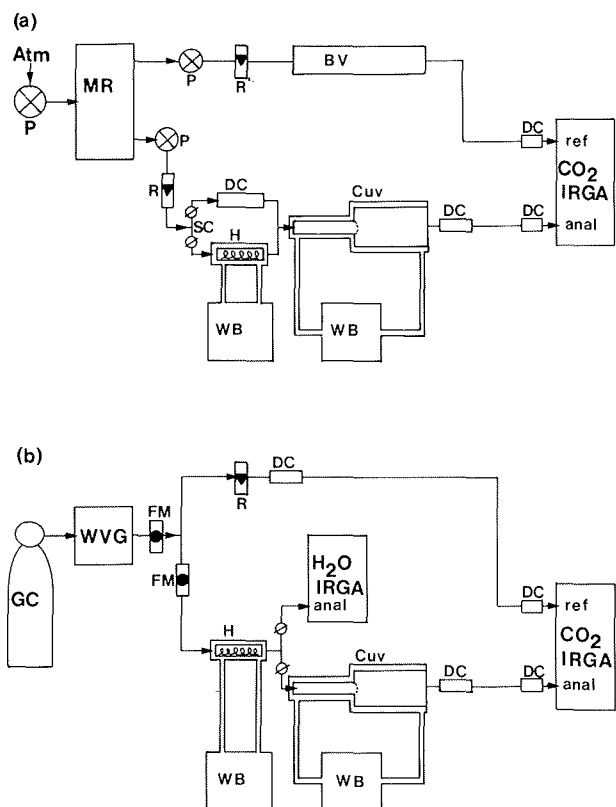

Fig. 1: Gas-flow systems employed for studying (a) the influence of thallus moisture content, and (b) the influence of light and temperature, on NAR. Anal = analysis cell of infra red gas analyser. Atm = atmosphere, BV = buffer volume, Cuv = lichen cuvette, DC = drying column, FM = flowmeter, GC = cylinder of compressed air, H = humidifier, MR = mixing reservoir, P = pump, R = rotameter, ref = reference cell of infra red gas analyser, SC = two-way stopcock, WB = temperature controllable water-bath, WVG = water vapour generator.

the lichen was removed, weighed, placed on a dry, preweighed weighing boat (without filter paper) and replaced in the cuvette. The incoming airstream was switched through the drying column, so that the lichen started drying out. CO₂ uptake rate immediately started changing. Periodically, the airstream was switched back through the humidifier, whereupon the CO₂ uptake rate became constant or changed only slowly. This rate was noted and the lichen removed, weighed and replaced in the cuvette with the airstream again coming from the drying column. After the experiment the sample was oven dried (60° C, 24 h), weighed and thallus moisture contents at the various uptake rates calculated. NAR was expressed as mg CO₂ per g dry weight of thallus.

For investigations of the influence of moisture content on dark respiration rate a similar procedure was used except that the cuvette was covered with aluminium foil and the lichen kept as dark as possible during weighing. In a study of the influence of thallus moisture content on NAR at high external CO₂ levels, a similar system to that in Figure 1a was used, except that the air pump and mixing reservoir supplying atmospheric air was replaced by a tank of compressed air containing 1122 µl CO₂ l⁻¹.

To investigate the influence of temperature and PPFD on NAR (Fig. 1b), air (330 to 350 µl CO₂ l⁻¹) from a compressed air tank was passed through an ADC WG 600 water vapour generator, through a calibrated flowmeter and split into two streams. One (200 cm³ min⁻¹) went via a rotameter and two drying columns to the reference cell of the CO₂ IRGA. The other airstream passed through a flowmeter and humidifier (described above) and was routed by a two-way stopcock into two alternative streams. One went directly to the analysis cell of an ADC water vapour IRGA calibrated and operating in absolute mode. In the alternative pathway the airstream went from the humidifier to the cuvette and then via two drying columns to the analysis cell of the CO₂ IRGA. The water vapour pressure of the airstream could be monitored by switching it through the H₂O IRGA and controlled using the water vapour generator and humidifier to give a vapour pressure deficit of < 0.1 kPa over the lichen. This system

worked well for cuvette air temperatures up to 25° C. Above this, the airstream was maintained at a water vapour pressure of 3.07 kPa to avoid condensation in the tubing. Cuvette air temperatures (shielded thermocouples) was varied by changing the temperature of an ethylene glycol/water mixture circulating through the water jacket and PPFD by changing the vertical position of the lamp or by using layers of grey shade netting. In these experiments, lichen temperature was monitored with a fine thermocouple pressed against the thallus undersurface.

The thallus was put onto a wad of wet tissue paper and placed in the cuvette. PPFD was adjusted to between 300 and 600 $\mu\text{mol m}^{-2} \text{s}^{-1}$ and the cuvette water jacket temperature adjusted to give a thallus temperature of 10 or 15° C. Initially, fairly dry air ($\pm 50\%$ relative humidity) was passed over the lichen. NAR increased rapidly as the lichen responded to light and then slowly as it dried out. When NAR showed signs of stabilizing (normally within an hour), the thallus moisture content was adjudged as being close to the optimum for NAR. The water vapour pressure of the incoming air was adjusted to give a vapour pressure deficit of <0.1 kPa and the PPFD/temperature trial commenced as follows. Initial thallus temperature was either 10 or 15° C and PPFD between 300 and 600 $\mu\text{mol m}^{-2} \text{s}^{-1}$. CO_2 uptake rate under these conditions was noted and PPFD lowered in steps down to zero. After each PPFD change the cuvette temperature was finely adjusted to maintain a constant thallus temperature. After changing the PPFD, CO_2 uptake rate usually stabilized within 10 minutes (mostly within 5 minutes) and was recorded. PPFD was then increased stepwise until the original value was reached. If CO_2 uptake was within 10% of the initial value, PPFD was increased in steps until light saturation was reached. This constituted one "light run". PPFD was then brought to the starting value, cuvette temperature changed, and humidity of the incoming air adjusted to give a vapour pressure deficit of <0.1 kPa. Another light run was performed at the new thallus temperature. Between light runs (i. e. temperature changes) conditions in the cuvette were brought back to those at the start of the experiment and if the CO_2 uptake rate was not within 10% of the initial value, the experiment was aborted. In this way it was possible to measure assimilation rates of a single thallus at up to 8 different temperatures and 7 to 15 PPFD values at each temperature in 12 to 16 h. For each thallus sample a light run was always made at a thallus temperature of 15° C. to enable comparisons of light and temperature photosynthetic responses between thalli. At temperatures above about 12° C, photoinhibition occurred at high PPFD levels. As soon as this was noted the PPFD was reduced, i. e. the 'light run' discontinued. In order to obtain data in the high temperature/high PPFD range (e. g. Fig. 4), after all the light runs were completed conditions were returned to the photoinhibitory range and the particular light runs continued. Generally only one, exceptionally two, such high temperature/high light runs were possible before the CO_2 exchange rate failed to return to the original value on establishing initial light and temperature conditions. After each experiment the lichen was oven-dried and weighed.

2.3 Acetylene Reduction Rate

To study the influence of thallus moisture content on AR, small ($\pm 4 \text{ cm}^2$) pieces of saturated thallus were gently shaken to remove excess surface water and placed in an open tray under natural lighting ($\pm 100 \mu\text{mol m}^{-2} \text{s}^{-1}$) and ambient temperatures (14 to 18° C) next to a laboratory window. Immediately, and thereafter at 5 to 10 minutes intervals a piece of thallus was placed in a preweighed glass incubation tube (13 mm i. d; 60 mm long) which was then lightly stoppered with cotton wool and placed obliquely in a water bath (20° C, PPFD 200 $\mu\text{mol m}^{-2} \text{s}^{-1}$) so that the stoppered end was well out of the water. While on the tray the pieces of thallus slowly dried out so that by sampling over a period, pieces with different water contents were obtained. After 40 tubes had received thallus samples the cotton wool was removed, the tubes wiped dry and weighed. They were then sealed with serum stoppers and positioned horizontally in racks. The racks were placed in a waterbath (20° C, PPFD 200 $\mu\text{mol m}^{-2} \text{s}^{-1}$) so that the dorsal surface of the thalli faced upwards. After 30 minutes preincubation, 10% of the tube volume was replaced with C_2H_2 which had been scrubbed twice through conc. H_2SO_4 and once through water. After 5 h further incubation the headspace gas was analysed for C_2H_4 as described below. The thallus pieces were oven-dried and weighed to calculate their moisture contents.

For investigations into the influence of temperature and PPFD, portions of freshly prepared thallus (equivalent to 0.05 to 0.1 g dry weight) were placed in incubation tubes which were immediately sealed with serum stoppers and positioned, dorsal parts of thallus upwards, in racks in waterbaths capable of maintaining a $\pm 10 \text{ cm s}^{-1}$ flow of coolant (ethylene glycol/water) around the tubes. A 400 watt SON lamp illuminated the tubes from above and PPFD could be varied by varying the height of the lamp and/or using shade netting. Temperature could be controlled using the waterbath thermostats. Using fine thermocouples it was established that even under high radiation loads air temperature in the tubes did not differ by more than 0.5° C, and thallus temperature by more

than 0.7° C, from the coolant temperature. After 30 minutes preincubation at the temperature and radiation values chosen for a particular incubation, 10% of the tube volume was replaced with scrubbed C₂H₂. The lichen samples were then incubated for 3 h before analysing the headspace gas for C₂H₄ as described below. They were then oven-dried and weighed.

To investigate nitrogenase activity in the dark in relation to the length of the dark period, and the recovery of dark activity on restoring light, pieces of thalli which had previously been exposed to 24 h light (c. 200 μmol m⁻² s⁻¹) at 10 to 15° C were added to 77 tubes which were placed in the dark (c. 15° C). Seven tubes were immediately incubated at 20° C in the dark under 10% C₂H₂ (3 h incubation preceded by 30 minutes preincubation). After 4, 8, 12 and 20 h a further seven tubes were assayed for AR in the dark. At 20 h the remaining tubes were returned to the light (c. 100 μmol m⁻² s⁻¹ PPFD, c. 15° C) and the recovery of dark AR activity monitored by assaying seven replicates for AR in the dark after a further 4, 8, 12, 16, 28 and 52 h.

In the investigation of the influence of glucose on AR in the dark, pieces of thallus which had been soaked in either water or 1% glucose solution under adequate light and temperature for 24 h were lightly patted dry and placed into 84 incubation tubes. Seven tubes of each treatment were immediately incubated at 20° C in the dark under 10% C₂H₂ (4 h incubation, preceded by 30 minutes preincubation). The remaining tubes were divided into 5 groups, each containing 7 tubes of each treatment. Each group was incubated in the dark for 48 h at either 0, 5, 10, 15 or 20° C and then assayed for AR in the dark at 20° C.

Concentrations of C₂H₄ in the incubation headspace gas were determined as follows. Immediately after the incubation period the incubation tubes were shaken vigorously for 15 s on a vortex mixer and the headspace subsampled using a double-sided needle into 3 ml blood-sampling tubes (Venoject; Terumo Corp., Tokyo) which had been evacuated to a consistent vacuum. C₂H₄ in the subsamples were determined within 6 h by gas chromatography on Poropak N. N₂ was the carrier gas and detection was by flame ionization. C₂H₄ concentrations were reported directly by a Hewlett Packard 3390A integrating reporter connected to the gas chromatograph. Endogenous C₂H₄ production was assessed for each treatment by incubating thallus samples without C₂H₂, but was never observed. C₂H₄ contamination of the scrubbed C₂H₂ was checked before each series of incubations; when it occurred fresh C₂H₂ was prepared. AR rates were expressed per g (dry weight) of lichen thallus.

2.4 *Thallus Field Moisture Contents*

Freshly collected whole lichens were carefully picked clean of peat and debris, weighed and oven-dried. They were reweighed and their moisture contents calculated as a percentage of the dry weight. Alternatively, the older decomposing parts of the lichen were discarded and only the younger portions used in the moisture content determinations.

3. RESULTS

3.1 *Influence of Thallus Moisture Content on NAR*

NAR first increased as thallus moisture content decreased from saturation and then declined with further moisture loss (Fig. 2). At 15° C and adequate light (PPFD 500 to 600 μmol m⁻² s⁻¹) optimum moisture contents for photosynthesis were mostly between 250 and 350% and the thalli showed a fairly broad range of water contents (generally 50 to 120%, but up to 180%) over which NAR values were within 10% of the maximum value. The decline in NAR with decreasing thallus moisture appeared to be sigmoidal and little or no photosynthesis occurred below 100% water content.

The response of dark respiration to thallus moisture content was examined on only three thalli (Fig. 3). In all cases a marked linear decline in respiration occurred as thallus moisture decreased from saturation to between about 310 and 350% water content. This was followed by a slower curvilinear decrease in respiration rate with further decline in moisture content.

3.2 *NAR Response to Light and Temperature*

The influence of PPFD on NAR at different temperatures is depicted in the results for two thalli (Figs. 4a and b) on which particularly fruitful experiments were possible (i. e. it was possible to obtain data for up to eight

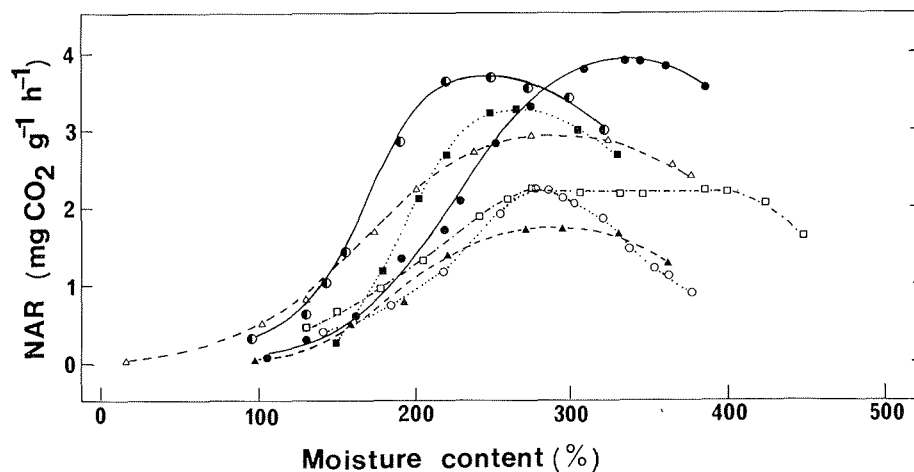

Fig. 2: Response of net CO_2 assimilation rate to thallus moisture content at adequate light (PPFD 500 to $600 \mu\text{mol m}^{-2} \text{s}^{-1}$) and temperature (air temperature in cuvette 15°C , thallus temperature c. 16 to 17°C). Curves were fitted by eye.

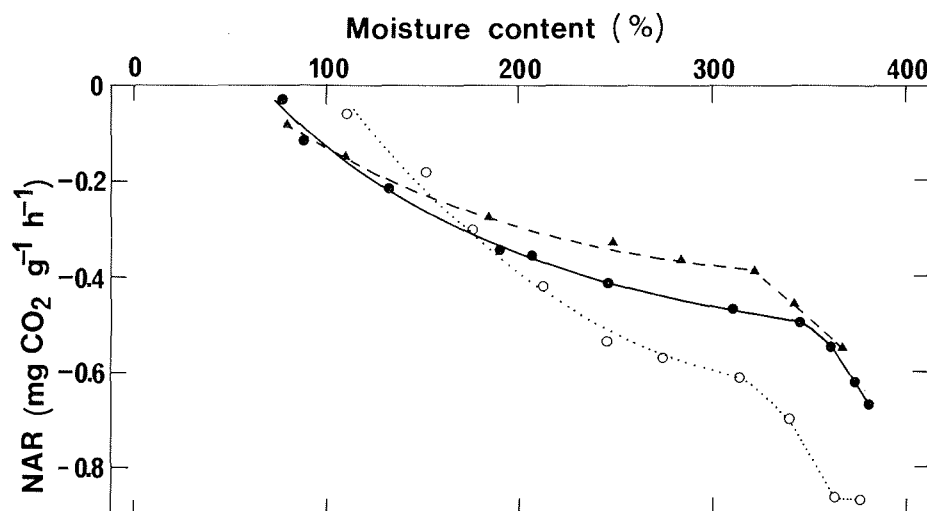

Fig. 3: Influence of thallus moisture content on dark respiration rate at a thallus temperature of c. 15°C . Each curve is for a separate thallus sample and was fitted by eye.

temperatures and, at two high temperatures, for photoinhibitory PPFD values, before the thalli became too stressed for further use). Less comprehensive PPFD/temperature experiments were performed on eight other thallus samples, but the photosynthetic curves in Figure 4 are representative of the results obtained for all of them.

Lowest temperature at which positive CO_2 exchange occurred was between -3°C and -2°C and, above this, NAR responded markedly to increasing PPFD and temperature at low levels of both. The increase in NAR with increasing PPFD's between 0 and $200 \mu\text{mol m}^{-2} \text{s}^{-1}$ (i. e. the initial slopes of the curves) depended on temperature, increasing up to about 15°C and then remaining constant, or even decreasing. Compensating PPFD (the value at which NAR is zero) was also markedly temperature-dependent and 87% ($P = 0.001$) of the variation in compensating PPFD above -1°C was explained by a positive exponential relationship with temperature (Fig. 5). Below -1°C , compensating PPFD increased rapidly with declining temperature. Saturating PPFD's were mostly

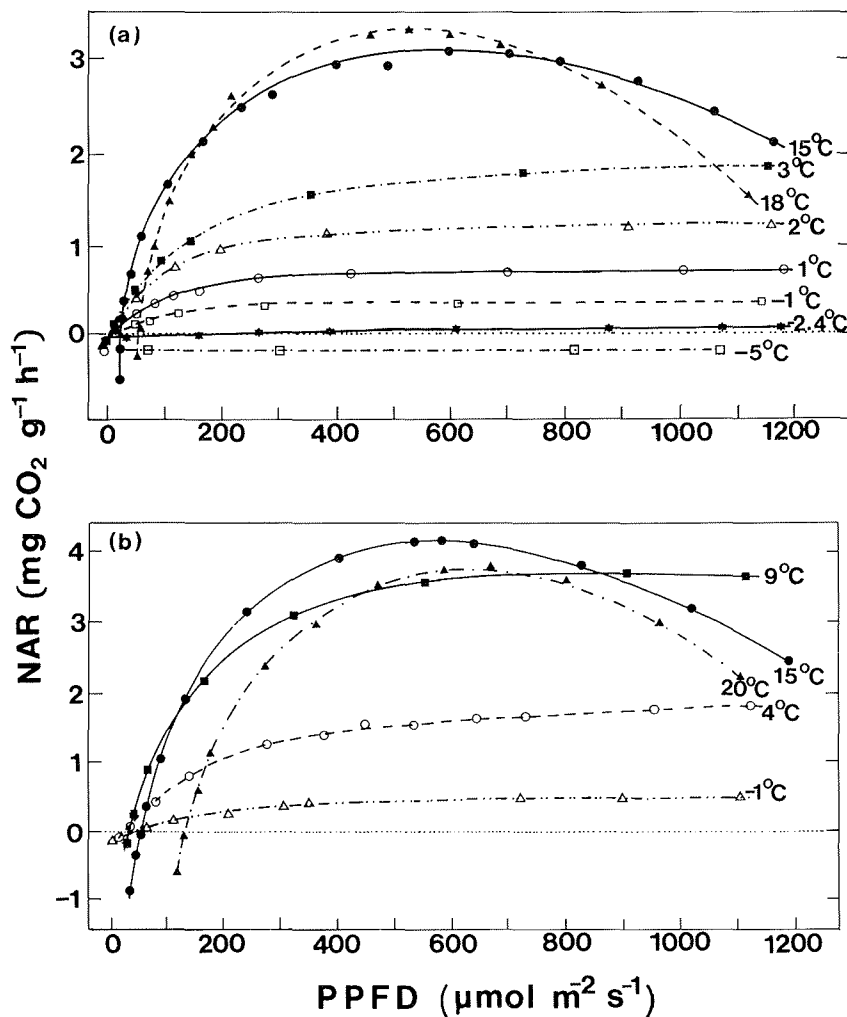

Fig. 4: Response of NAR to light at various temperatures. (a) and (b) are separate thallus samples. Curves were fitted by eye.

between 400 and 600 $\mu\text{mol m}^{-2} \text{ s}^{-1}$ but in some instances, especially at intermediate temperatures (3 to 12°C), full saturation was not attained until higher PPFD levels (800 to 1200 $\mu\text{mol m}^{-2} \text{ s}^{-1}$). At temperatures above 14°C, photoinhibition occurred at PPFD's above about 600 $\mu\text{mol m}^{-2} \text{ s}^{-1}$, the extent of which increased with temperature.

Experiments concerned solely with the influence of temperature on rates of dark respiration were carried out on three thallus samples and the results (Fig. 6) closely resemble the NAR versus temperature curves obtained at zero PPFD from the thalli used in the PPFD/temperature trials. Respiration occurred down to -5°C (e. g. see lower-most curve in Figure 4a) and increased with temperature (Fig. 6), the increases up to about 24°C being adequately described ($r > 0.82$, $P < 0.001$) by Arrhenius equations. Q_{10} values between 0 and 24°C were from 2.1 to 3.6. Above 24°C, respiration rate increased more slowly than predicted by the Arrhenius equations.

The CO_2 exchange data from the ten thalli used in the PPFD/temperature trials and the three used in the dark respiration studies were normalized by expressing exchange rates at the various combinations of PPFD and temperature as a percentage of the maximum rate found at 15°C. The normalized data were used to construct a

computer-generated CO₂ exchange response surface with PPFD and temperature as the two independent variables

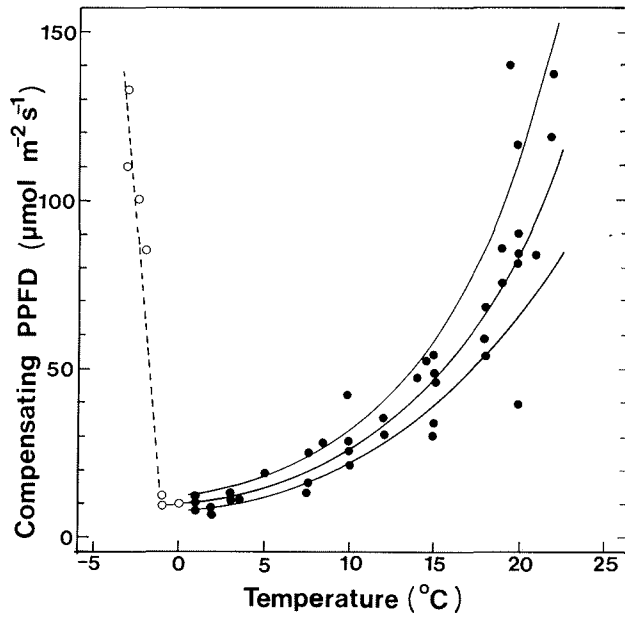

Fig. 5: Compensating PPFD FOR CO₂ exchange as a function of thallus temperature. Data points are empirical values found during the light/temperature trials and an exponential curve has been fitted for temperatures between 0 and 22° C. The upper and lower lines indicate the 95% confidence limits of the curve.

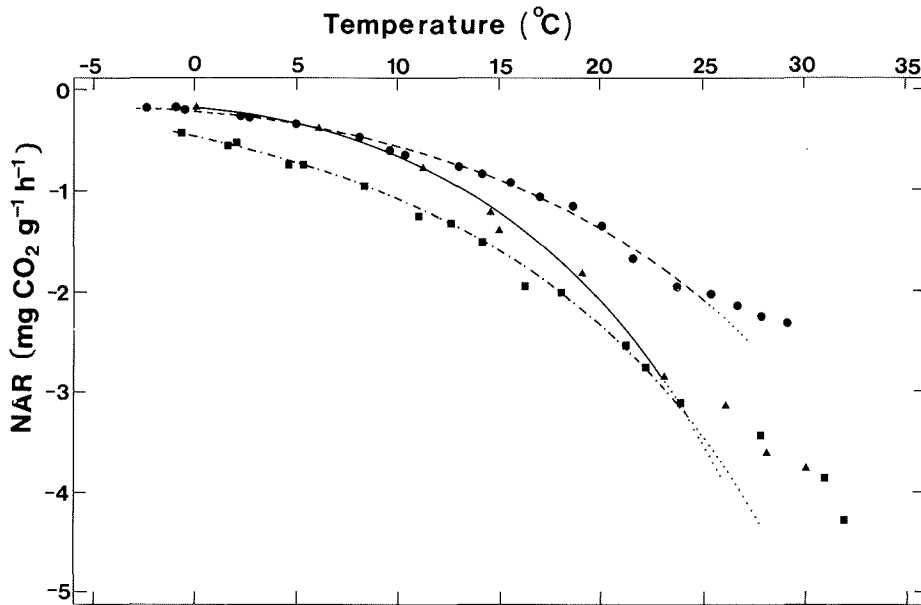

Fig. 6: Response of dark respiration rate to thallus temperature. Data are presented for three thallus samples and curves were fitted using Arrhenius equations.

(Fig. 7). The strong interaction between light and temperature in the lichen's photosynthetic characteristics is very apparent in the three-dimensional plots.

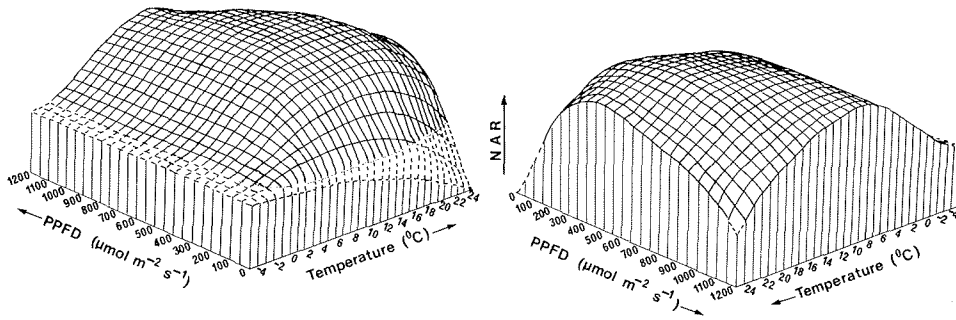

Fig. 7: Response surface of NAR to light and thallus temperature. Dashed portions of curves indicate negative NAR, i.e. respiration.

Where there is sufficient light (e. g. $PPFD > 50 \mu\text{mol m}^{-2} \text{s}^{-1}$), CO_2 exchange becomes positive at about -2°C and the rate increases rapidly as temperature rises so that, depending on PPFD, at 0°C it is between 10 and 30%, and at 5°C it is between 60 and 80%, of the maximum value. The optimum temperature range for net photosynthesis (here taken as the temperature range in which NAR is within 10% of the maximum value) depends on PPFD for both its breadth and absolute values. At low PPFD's (c. 40 to $100 \mu\text{mol m}^{-2} \text{s}^{-1}$) the optimum range is about 5 to 13°C , at intermediate PPFD's (200 to $800 \mu\text{mol m}^{-2} \text{s}^{-1}$) it is about 8 to 18°C and at high PPFD's ($> 1000 \mu\text{mol m}^{-2} \text{s}^{-1}$) it is 7 to 12°C . The depression of the temperature optimum at low light levels is caused by enhanced dark respiration rates at high temperatures, whereas at high light values it is caused by photoinhibition, possibly due to photorespiration which might be expected to increase with both light and temperature. NAR responded very markedly to PPFD at temperatures above 0°C , so that at $200 \mu\text{mol m}^{-2} \text{s}^{-1}$ (a typical value for the island but only about 10% of full sunlight) it was between 60 and 80% (depending on temperature) of the light-saturated NAR value.

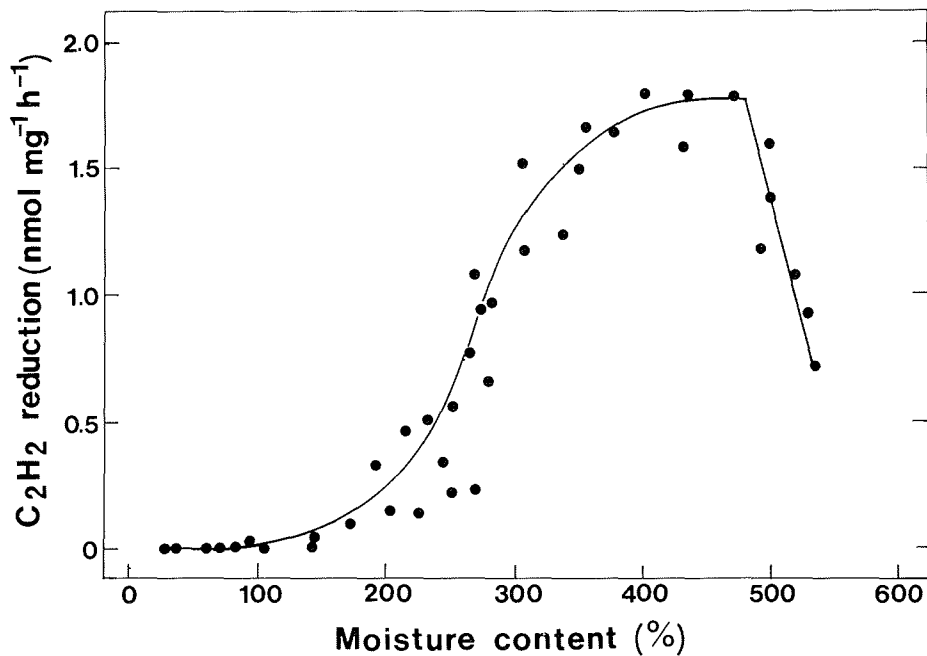

Fig. 8: Influence of thallus moisture content on acetylene reduction rate. Curve fitted by eye.

The response surface shows that maximum NAR occurs on a central plateau bounded by approximately 8 and 18° C, and 400 and 800 $\mu\text{mol m}^{-2} \text{s}^{-1}$, with a spur extending this plateau to higher PPFD's (up to 1200 $\mu\text{mol m}^{-2} \text{s}^{-1}$) between about 8 and 11° C.

3.3 Influence of Thallus Moisture Content on Acetylene Reduction

Little or no AR occurred at thallus moisture contents below 150% (Fig. 8). Above this, AR increased with increasing moisture contents to maximum values between about 380 and 460%, and then declined sharply with further increases in thallus moisture. In this experiment the soaked thallus samples were gently shaken, not lightly patted dry as in the NAR experiments, and samples exhibiting moisture contents above c. 400% always had a noticeable layer of water on their surface.

3.4 Influence of Light on Acetylene Reduction

Michaelis-Menten kinetics explained 91% ($P < 0.001$) of the increase in AR rates at 20° C as PPFD increased from 0 to 900 $\mu\text{mol m}^{-2} \text{s}^{-1}$ (Fig. 9). The value of K_{PPFD} (the PPFD at which half of the maximum AR rate occurred) was 14 $\mu\text{mol m}^{-2} \text{s}^{-1}$, indicating that nitrogenase activity in the lichen responds markedly to light at low levels. AR was within 90% of the fully saturated value at about 40 $\mu\text{mol m}^{-2} \text{s}^{-1}$ PPFD and rate increases were very small above 100 $\mu\text{mol m}^{-2} \text{s}^{-1}$. At 20° C there was no suggestion that AR was inhibited at higher light levels, at least not up to 900 $\mu\text{mol m}^{-2} \text{s}^{-1}$.

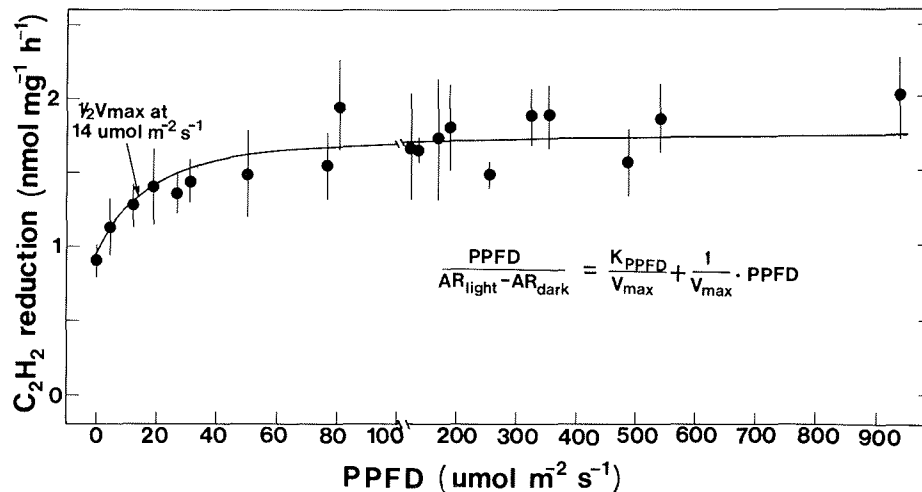

Fig. 9: Relationship between acetylene reduction at 20° C and light between PPFD's of 0 and 900 $\mu\text{mol m}^{-2} \text{s}^{-1}$. Each data point is the mean of eight replicate thalli and vertical bars indicate the standard errors. The curve fitted was derived from the modified Michaelis-Menten formula given in the Figure.

3.5 Influence of Temperature on Acetylene Reduction

The influence of temperature on AR was investigated at adequate light (PPFD, 200 $\mu\text{mol m}^{-2} \text{s}^{-1}$) and in the dark. Thallus moisture contents in this investigation were between 350 and 400%. In the light (Fig. 10a), AR increased markedly between 0 and 22° C, the increase being accurately ($r = 0.966$, $P < 0.001$) described by an Arrhenius equation. Q_{10} values predicted by the equation were from 3.3 and 3.6 for temperatures between 0 and 20° C. AR in the dark also increased with temperature (Fig. 10b), but at a lower rate of increase than in the light, so that Q_{10} values predicted by the Arrhenius equation ($r = 0.930$, $P < 0.001$) were only 2.1 to 2.2. Below 0° C, AR rates in the light and in the dark declined with temperature more rapidly than predicted by the Arrhenius curves. Low AR rates (light, $0.14 \pm 0.02 \text{ nmol mg}^{-1} \text{ h}^{-1}$; dark, $0.17 \pm 0.03 \text{ nmol mg}^{-1} \text{ h}^{-1}$) occurred at -2° C but at -4.5° C none of the 16 thallus replicates reduced acetylene.

Optimum temperatures for AR was c. 22° C in the light and c. 21° C in the dark, although in the latter case the temperature optimum was quite broad (between 18 and 23° C). Above these temperature optima AR rates declined

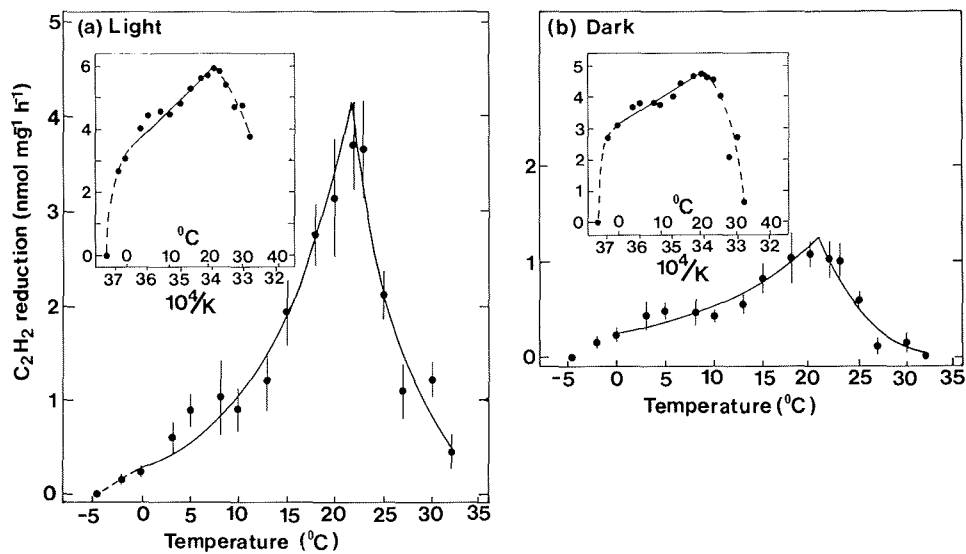

Fig. 10: Relationship between acetylene reduction and temperature in (a) the light (PPFD, 200 $\mu\text{mol m}^{-2} \text{s}^{-1}$) and (b) the dark. Each data point is the mean of 8 replicates and vertical bars indicate the standard errors. Insets: Arrhenius plots of log AR versus the reciprocal of absolute temperature ($\times 10^4$).

markedly. At 32° C, the highest temperature employed in the experiment, the rate in the light ($0.44 \pm 0.11 \text{ nmol mg}^{-1} \text{ h}^{-1}$) was significantly ($P = 0.01$) greater than at 0° C ($0.23 \pm 0.10 \text{ nmol mg}^{-1} \text{ h}^{-1}$), whereas in the dark, the rate at 32° C ($0.02 \pm 0.06 \text{ nmol mg}^{-1} \text{ h}^{-1}$) was significantly ($P = 0.001$) lower than at 0° C ($0.23 \pm 0.04 \text{ nmol mg}^{-1} \text{ h}^{-1}$).

The relationship between AR rates in the dark and those in the light was strongly temperature dependent, so that as temperature increased, dark AR represented a smaller proportion of light AR (Fig. 11). Data points in Figure 11 are the dark AR/light AR ratios corresponding to the data in Figures 10a and b and the curve shows the ratios of AR rates predicted from the two Arrhenius equations. Between 0 and 25° C the curve of predicted ratios fits the actual data quite well ($r = 0.800$, $P = 0.01$). Above 25° C dark AR rates declined more rapidly with temperature

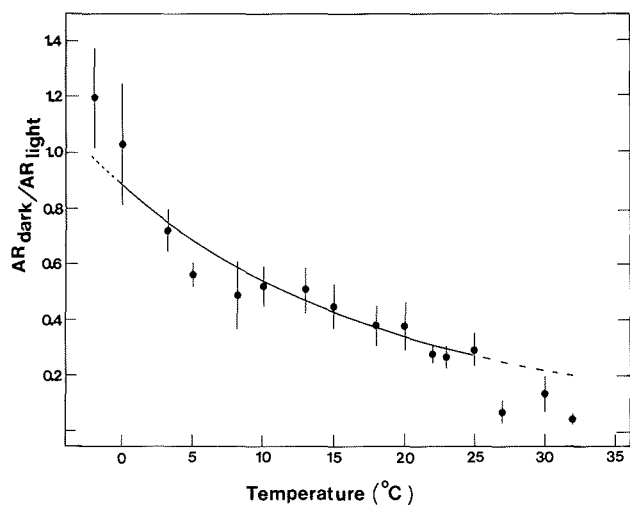

Fig. 11: Relationship between acetylene reduction rate in the dark and that in the light, as a function of temperature. Data points are mean observed ratios (vertical bars indicate the standard errors) and the curve shows the ratios predicted from the two Arrhenius curves in Figure 10.

than did the light AR rates, so that the ratios of dark AR to light AR above 25° C were lower than predicted from the Arrhenius curves. At 0° C, dark AR was approx. equal to light AR. At -2° C dark AR ($0.17 \pm 0.03 \text{ nmol mg}^{-1} \text{ h}^{-1}$) was slightly but significantly ($P = 0.05$) greater than light AR ($0.14 \pm 0.02 \text{ nmol mg}^{-1} \text{ h}^{-1}$), yielding a dark AR:light AR ratio of >1.

3.6 Effect of Long-term Dark Periods on Acetylene Reduction and the Interaction between Glucose and Temperature

AR rates (at 20° C) declined rapidly in the dark so that after 12 h rates were very low and after 20 h were zero (Fig. 12). After returning the lichen to the light, dark AR rates started recovering within 4 h and after 16 h full activity was restored. The decline in nitrogenase activity in the dark has been explained by a decline in carbohydrate-based oxidative phosphorylation, caused by depletion of carbohydrate reserves (KERSHAW 1985). The results of an experiment in which dark AR (at 20° C) for water- or glucose-treated thalli was measured following a 24 h light pretreatment, and again after 48 h in the dark at various temperatures, are presented in Table 1. Glucose pretreatment increased dark AR rates at the start of the dark period by approximately 3 1/2 times. The decline in dark AR over 48 h in the dark was markedly temperature-dependent for both water- and glucose-treated thalli. thalli held at 0° C and 5° C exhibited AR rates (at 20° C) which were c. 30% and 26% respectively of initial rates. Water-treated thalli held at higher temperatures showed no nitrogenase activity in the dark after 48 h,

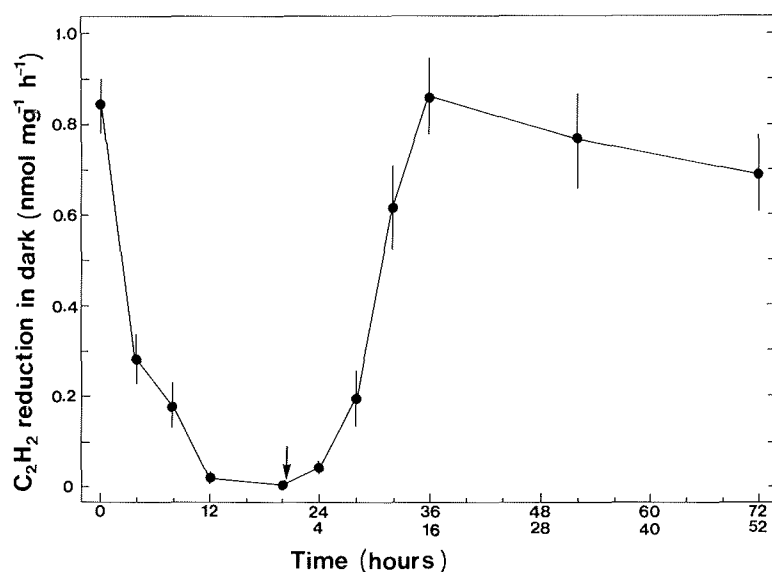

Fig. 12: Time course of nitrogenase activity in the dark and subsequent recovery of dark activity on exposure to light (all C_2H_2 -reduction incubations were in the dark at 25° C). Prior to the experiment the thallus samples were exposed to adequate light (PPFD c. 200 and $\text{m}^2 \text{ s}^{-1}$) at moderate temperatures (15 to 20° C). For the first 20 hours they were kept in the dark at c. 15° C and then (arrowed) placed in light (c. $100 \mu\text{mol m}^{-2} \text{ s}^{-1}$, 15° C). Data points are means for 7 replicated thalli and vertical bars indicate standard errors. Lower time scale (abscissa) indicates the period of recovery in the light.

	Water treatment		Glucose treatment	
	$\text{nmol mg}^{-1} \text{ h}^{-1}$	% of initial rate	$\text{nmol mg}^{-1} \text{ h}^{-1}$	% of initial rate
Freshly collected thalli	204 ± 78	—	703 ± 116	—
Thalli at 0° C	61 ± 14	30	206 ± 20	29
Thalli at 5° C	52 ± 18	26	135 ± 31	26
Thalli at 10° C	0	0	57 ± 42	8
Thalli at 15° C	0	0	18 ± 23	3
Thalli at 20° C	0	0	0	0

Tab 1: Acetylene reduction (Mean \pm SD; $n = 7$) by *Peltigera* in the dark at 20° C, after 48 h dark pretreatment at various temperatures. Prior to the dark pretreatment the thalli were soaked in either water or glucose solution.

whereas glucose-treated thalli showed some activity after 48 h in the dark at 10 or 15° C, but none when held at 20° C. These results support the suggestion that oxidative phosphorylation supports nitrogenase activity in the dark and show that the decline in activity as the dark period progresses can be ameliorated by an exogenous supply of carbohydrate or by lowering the temperature and thereby showing the depletion of carbohydrate reserves. However, the fact that the decrease in activity over 48 h in the dark at 0 and 5° C were the same, relative to the initial values, for the glucose- and water-treated replicates suggests that other factors are also important, e. g. the likelihood that glucose uptake, not only its utilization, is temperature-dependent.

3.7 Influence of Phosphorus on Acetylene Reduction

Pre-soaking thalli in phosphate-P solution significantly ($P = 0.01$) enhanced AR rates over water-treated thalli, in both light and dark. AR rates were: light, $0.41 \pm 0.10 \text{ nmol mg}^{-1} \text{ h}^{-1}$ for water-treated thalli and $0.77 \pm 0.26 \text{ nmol mg}^{-1} \text{ h}^{-1}$ for P-treated thalli; dark, $0.17 \pm 0.09 \text{ nmol mg}^{-1} \text{ h}^{-1}$ water-treated, $0.29 \pm 0.08 \text{ nmol mg}^{-1} \text{ h}^{-1}$ P-treated.

4. DISCUSSION

Field moisture contents of whole lichens and lichen mats in the field after 24 to 48 h without rain were between 194 and 356% (mean $244 \pm 70\%$, $n = 12$) on a dry weight basis and after rainy periods were from 406 to 519% ($435 \pm 52\%$, $n = 18$). These values refer to whole thalli, i. e. they include the "spongy" basal parts which possess higher moisture contents than the younger portions of the thallus used in the experiments described above. Also, the basal portions of the thalli could not always be completely cleaned of peat and decomposing bryophytes, both of which possess high moisture levels. Younger parts of the thallus exhibited lower field moisture contents: 168 to 261% ($197 \pm 26\%$, $n = 12$) after "dry" periods and 242 to 347% ($305 \pm 59\%$, $n = 12$) after rainy periods. The latter are very close to the optimal range for NAR (c. 250 to 350%, Fig. 2). Precipitation on the island is high, c. 2500 mm per year, occurs mainly as rain and is evenly distributed throughout the year. Humidity is high ($> 80\%$) and drought or arid periods do not occur. In addition, the *Peltigera* species considered here mostly occurs in very wet, generally waterlogged habitats and has never been observed to dry out to any appreciable extent. However, during infrequent rainless periods of longer than a day or two, thallus moisture contents do fall to values below the optimum. These periods most often correspond to relatively sunny times when light and temperature are favourable, so that NAR is probably then limited by moisture content. The decreased rates of net photosynthesis at high levels of thallus hydration are largely due to the high rates of respiration associated with full thallus water content and also to a high impedance to CO_2 diffusion in the fully saturated thallus (SNELGAR et al. 1981, LANGE & TENHUNEN 1981). The effect of an elevated internal diffusive resistance was not ameliorated by an ambient CO_2 concentration of 1122 ppm. Probably this concentration was still too low to increase the CO_2 gradient sufficiently to counteract the slow diffusion rate at thallus saturation, e. g. LANGE & TENHUNEN (1981) found that CO_2 uptake by *Ramalina maciformis* was depressed by high moisture contents at 1000 ppm CO_2 , but not at 1600 ppm CO_2 .

Field moisture contents of the younger portions of the thalli were generally below the optimum for nitrogenase activity (c. 350 to 450%, Fig. 8). The rapid decline in AR at supra-optimal water contents ($> \text{c. } 500\%$) is a feature not generally reported for other lichens species. It could have been due to excessively high rates of respiration or other metabolic activities which compete with nitrogen fixation for energy sources, or to the possibility that at the very high moisture contents the thalli were still in a rehydration phase of high respiration rate and low nitrogenase activity which follows water soaking in many lichens (KERSHAW 1985). However, this unlikely since the AR assay was carried out several hours after soaking. TYSIACZNY & KERSHAW (1979) demonstrated that in some *Peltigera* species there is excessive movement of glucose out of the phycobiont at very high thallus moisture contents. If this was true for the species studied here, it could have caused the observed decline in nitrogenase activity at high moisture contents by depleting the energy supply required for nitrogen fixation. Another explanation of the depression of AR at very high moisture levels possibly lies in the slower diffusion of C_2H_2 and C_2H_4 through a water-saturated thallus. In the field, younger portions of the lichen thallus never reached the high moisture content levels at which nitrogenase activity is so severely affected, although basal parts of the thalli occasionally did so.

Results presented here support previous findings that nitrogen fixation is more sensitive to variation and extremes of temperature than are other physiological processes such as photosynthesis or respiration (BURK 1934,

WHITTON & SINCLAIR 1975, KALLIO & KALLIO 1978). Organisms are considered to be mesophilic regarding nitrogen fixation (GRANHALL 1981) and generally not able to fix N effectively below 0° C (ALEXANDER 1975). Many studies at subpolar sites (e. g. HORNE 1972; KALLIO et al. 1972, ALEXANDER & SCHELL 1973, ENGLUND & MEYERSON 1974, DAVEY 1983, SMITH 1984) have demonstrated low, but still appreciable rates of fixation at low temperatures down to 0° C and it has been suggested that the lack of liquid water below 0° C probably limits N fixation, rather than low temperature inactivation of nitrogenase (HORNE 1972). In Figures 10a and b, freezing possibly accounted for a greater decline in AR rates below 0° C than predicted from the curves.

Q₁₀ values (2.1 to 3.0) found here for AR are lower than those (4 to 6) reported for lichenized and non-lichenized N-fixing cyanobacteria from subpolar sites and were more similar to values reported from more temperate areas (GRANHALL 1981). Q₁₀'s for AR by cyanobacteria associated with mosses at the island are between 2.3 and 2.9 (SMITH 1984) similar to the values found here. Optimum temperature for AR in the *Peltigera* lichen studied here was 21 to 22° C and is probably underestimated slightly. These values refer to the coolant liquid surrounding the incubation tubes and, at about 20° C, actual thallus temperatures in the light may have been up to 0.5° C higher. Optimum temperatures for AR were therefore probably about 22 to 23° C, higher than those (15 to 21° C) often reported for lichenized and non-lichenized cyanobacteria from Northern Hemisphere tundras (KALLIO et al. 1972, ENGLUND & MEYERSON 1974, GRANHALL 1975, ALEXANDER et al. 1978). KERSHAW (1985) has criticized some of these findings, mostly on experimental procedural grounds, and has stated that an optimal level of nitrogenase activity below 20° C is unlikely. From examination of the data sets which he considers arose from an adequate experimental design, he suggested that lichens from the low Arctic zone possess temperature optima for nitrogenase activity of about 25° C, and those from more temperate areas show optima between 25 and 30° C.

While it could not unequivocally be demonstrated that AR by the cyanobacteria associated with mosses was phosphorus-limited (SMITH 1984), this was certainly the case for the lichen species studied here. ALEXANDER et al. (1978) found that AR in *Peltigera aphthosa* from an Arctic tundra at Barrow Alaska responded to moderately enhanced P concentrations but concluded that the low P levels found there were probably unimportant in limiting nitrogen fixation. On Marion Island, P concentrations in the mire soil solutions are very low (generally undetectable; SMITH 1987c) and no P occurs in the rainwater (SMITH 1987d). Except where manuring by birds occurs, the *Peltigera* species being considered here occurs in P-deficient habitats and this may be a significant negative factor regarding its nitrogen fixation capacity.

Maximum net photosynthetic rates found for the lichen (c. 4 mg CO₂ g⁻¹ h⁻¹; Figures 2 and 4) are similar to values reported for *Peltigera* species elsewhere, e.g. 3.9 to 4.5 mg g⁻¹ h⁻¹ for *P. canina* (RIED 1960) and c. 4 to 6 mg g⁻¹ h⁻¹, depending on time of year, for *P. canina* and *P. polydactyla* (KERSHAW 1977). Maximum AR rates reported here (c. 4 nmol C₂H₂ mg⁻¹ h⁻¹, Fig. 10) are also similar to values reported for other *Peltigera* species, e.g. 3.6 to 4 nmol mg⁻¹ h⁻¹ for *P. polydactyla* (HITCH & MILLBANK 1975, KERSHAW & DZIKOWSKI 1977), 3.9 to c. 4 nmol mg⁻¹ h⁻¹ for *P. canina* (HITCH & MILLBANK 1975, KERSHAW 1974) and c. 5 nmol mg⁻¹ h⁻¹ for *P. evansiana* (KERSHAW 1974). MACFARLANE & KERSHAW (1977) reported higher maximum AR values (up to 15 nmol mg⁻¹ h⁻¹) for *P. praetextata* and *P. rufescens* collected in winter in Ontario, although both species exhibited rates similar to those found here when collected in other seasons. The extent of any seasonal variation which may occur in photosynthetic or nitrogen fixation capacities of the lichen on the island is not known and the results presented here are for April/May, which is mid-autumn on the island. The island's hyperoceanic climate ensures small diurnal and seasonal temperature variations (eg. there is only a c. 4° C difference between the average temperatures of the warmest and coldest months). It is unlikely, therefore, that there is much seasonal variation in the temperature characteristics of the lichen's photosynthetic or nitrogen fixation capabilities. However, there is a 5 to 6 fold increase in daily radiation from midwinter to midsummer, due to higher sun angles and longer days in the summer months, although irradiance levels are generally low throughout the year. Because of the strong dependence of NAR on light at low levels, and the isothermal nature of the climate, carbon assimilation by the lichen is probably more closely related to the island's light, rather than its temperature, regime, and most of the lichen's annual carbon accumulation probably occurs in summer. This may also be true for nitrogen acquisition by the lichen through biological fixation, despite the observed noninteraction between nitrogenase activity and light levels above a very low threshold. Nitrogenase activity declines with increasing length of the dark period (Fig. 12) and becomes very low after 12 h. CRITTENDON & KERSHAW (1979) showed that while

light is the prime requirement for the recovery of activity, the rate of recovery is directly related to temperature. In summer the short nights, coupled with moderately low temperatures (generally between 3 and 8° C during the night) would ensure that nitrogen fixation could continue at low but appreciable rates. During the day the greater irradiance levels and duration of incident radiation (especially the more frequent occurrence of periods of direct radiation, and hence the greater potential for warming of the lichen thallus) would ensure a rapid recovery of nitrogenase activity. In winter the nights are long and the lichens are often covered by snow, causing prolonged dark conditions during which the depletion of carbohydrate reserves for nitrogen fixation would be severe. In addition, the lower temperatures and reduced chance of direct radiation to warm the lichen in winter would reduce the rate of recovery of nitrogenase activity during the day.

5. CONCLUSIONS

The significance of the results presented here to the lichen's annual acquisition of carbon and nitrogen can only be assessed once a detailed microclimatological description of the habitats in which it occurs becomes available, the seasonal variation in its photosynthetic and nitrogen fixation capabilities is understood, and the relative affinities of its nitrogen fixation system for acetylene and for nitrogen are known. Considering the isothermal oceanic climate it is perhaps unlikely that the lichen's photosynthetic and nitrogen fixing characteristics show conspicuous seasonal variations. Judging from the lichen's marked photosynthetic and nitrogen fixation response to increasing light at low levels, it appears ideally suited to the cloudy, low-light environment of the sub-Antarctic. The frequent occurrence of rain and high humidity on the island ensure that thallus moisture contents do not fall to levels where CO₂ assimilation or N fixation is not possible. The infrequent occurrence of very cold weather (monthly average minimum air temperatures never fall below 0° C) ensures that temperature seldom totally inhibits photosynthesis or nitrogen fixation. Die lichen's relative insensitivity, in terms of photosynthesis, to decreasing temperatures below the optimum (e. g. at 5° C photosynthetic rates had only fallen 20 to 40% below maximum rates) probably allows it to maintain a substantially positive carbon exchange rate over the whole year. In addition, it is likely that thallus temperatures are often higher than ambient (e.g. HUNTLEY 1971 reported temperatures in the surface layers of cushion plants and peats on the island which were up to 15° C higher than air temperatures) and during such periods both carbon assimilation and nitrogen fixation may occur at, or close e.g. maximum rates.

References

- Alexander, V. (A synthesis of the IBP tundra biome study of nitrogen fixation. — In: A. J. Holding, O. W. Heal, S. F. MacLean and P. W. Flanagan (eds.), Soil organisms and decomposition in tundra: 109—121. Tundra Biome Steering Committee, Stockholm, Sweden.
- Alexander, V. (1975): Nitrogen fixation by blue-green algae in polar and subpolar regions. — In: W. D. P. Stewart (ed.), Nitrogen fixation by free-living microorganisms: IBP6, Cambridge University Press, Cambridge, England.
- Alexander, V., Billington, M. & Schell, D. M. (1978): Nitrogen fixation in Arctic and alpine tundra. — In: L. L. Tieszen (ed.), Vegetation and production ecology of an Alaskan Arctic tundra: 539—558. Ecological Studies 29, Springer-Verlag, New York.
- Alexander, V. & Schell, D. M. (1973): Seasonal and spatial variation of nitrogen fixation in the Barrow, Alaska, tundra. — Arct. Alp. Res. 5: 77—88.
- Burk, D. (1934): Azotase and nitrogenase in *Azotobacter*. — *Ergeb. Enzymforsch.* 3: 23—56.
- Crittendon, P. D. & Kershaw, K. A. (1979): Studies on lichen-dominated systems. XXII. The environmental control of nitrogenase activity in *Stereocaulon paschale* in spruce-lichen woodland. — *Can. J. Bot.* 57: 236—254.
- Davey, A. (1983): Effects of abiotic factors on nitrogen fixation by blue-green algae in Antarctica. — *Polar Biol.* 2: 95—100.
- Englund, B. & Meyerson, H. (1974): In situ measurements of nitrogen fixation at low temperatures. — *Oikos* 25: 283—287.
- Granhall, U. (1975): Nitrogen fixation by blue-green algae in temperate soils. — In: W. D. P. Stewart (ed.), Nitrogen fixation by free-living microorganisms: 189—197. IBP6, Cambridge University Press, Cambridge, England.
- Granhall, U. (1981): Biological nitrogen fixation in relation to environmental factors and functioning of natural ecosystems. — *Ecol. Bull. Naturvetensk. Forskningsrådet* 33: 131—144.
- Gremmen, N. J. M. (1981): The vegetation of the Subantarctic islands Marion and Prince Edward. — *Geobotany* 3: 1—149. Dr. W. Junk, The Hague.
- Hitch, C. J. B. & Millbank, J. W. (1975): Nitrogen metabolism in lichens. VII. Nitrogenase activity and heterocyst frequency in lichens with blue-green phycobionts. — *New Phytol.* 75: 239—244.
- Horne, A. J. (1972): The ecology of nitrogen fixation on Signy Island, South Orkney Islands. — *Br. Antarct. Surv. Bull.* 27: 1—18.
- Kallio, P. & Kallio, S. (1978): Adaptation of nitrogen fixation to temperature in the *Peltigera aphthosa*-group. — In: U. Granhall (ed.), Environmental role of nitrogen-fixing blue-green algae and symbiotic bacteria. *Ecol. Bull.* 26: 225—233. Swedish natural Science Research Council (NFR), Stockholm.
- Kallio, P., Suhonen, S. & Kallio, H. (1972): The ecology of nitrogen fixation in *Nephroma arcticum* and *Solorina crocea*. — *Rep. Kevo Subarct. Res. Stn* 9: 7—14.
- Kershaw, K. A. (1974): Dependence of the level of nitrogenase activity on the water content of the thallus in *Peltigera canina*, *P. evansiana*, *P. polydactyla* and *P. praetextata*. — *Can. J. Bot.* 52: 1423—1427.

- Kershaw, K. A. (1977): Physiological-environmental interactions in lichens. II. The pattern of net photosynthetic acclimation in *Peltigera carina* (L.) Willd var. *praetextata* (Floerke in Somm.) Hue, and *P. polydactyla* (Neck.) Hoffm. — *New Phytol.* 79: 377—390.
- Kershaw, K. A. (1985): Physiological ecology of lichens. — Cambridge University Press, Cambridge. 293 pp.
- Kershaw, K. A. & Dzikowski, P. A. (1977): Physiological-environmental interactions in lichens. VI. Nitrogenase activity in *Peltigera polydactyla* after a period of desiccation. — *New Phytol.* 79: 417—421.
- Lange, O. L. & Tenhunen, J. D. (1981): Moisture content and CO₂ exchange of lichens. II. Depression of net photosynthesis in *Ramalina maciformis* at high water content is caused by increased thallus carbon dioxide diffusion resistance. — *Oecologia (Berl.)* 51: 416—429.
- Lewis, Smith, R. I. (1984): Terrestrial plant biology of the sub-Antarctic and Antarctic. — In: R. M. Laws, Ed., *Antarctic Ecology* vol. 3: 61—161. Academic Press, London.
- Lindsay, D. C. (1976): The lichen of Marion and Prince Edward Islands, southern Indian Ocean. — *Nova Hedwigia* 28: 667—689.
- MacFarlane, J. D. & Kershaw, K. A. (1977): Physiological-environmental interactions in lichens. IV. Seasonal changes in the nitrogenase activity of *Peltigera canina* (L.) Willd var. *praetextata* (Floerke in Somm.) Hue, and *P. canina* (L.) Willd var. *rufescens* (Weiss) Mudd. — *New Phytol.* 79: 403—408.
- Pamenter, N. W., Drennan, P. M. & Smith, V. R. (1986): Physiological and anatomical aspects of photosynthesis of two *Agrostis* species at a sub-Antarctic island. — *New Phytol.* 102: 143—160.
- Ried, A. (1960): Thallusbau und Assimilationshaushalt von Laub- und Krustenflechten. — *Biol. Zentralbl.* 79: 129—151.
- Smith, V. R. (1984): Effects of abiotic factors on acetylene reduction by cyanobacteria epiphytic on moss at a Subantarctic island. — *Appl. Environ. Microbiol.* 48: 594—600.
- Smith, V. R. (1987a): Production and nutrient dynamics of plant communities on a sub-Antarctic island. 1. Standing crop and primary production of mire-grasslands. — *Polar Biol.* 7: 57—75.
- Smith, V. R. (1987b): Production and nutrient dynamics of plant communities on a sub-Antarctic island. 2. Standing crop and primary production of tjaeldmark and fernbrakes. — *Polar Biol.* 7: 125—144.
- Smith, V. R. (1987c): Seasonal changes in plant and soil chemical composition at Marion Island (sub-Antarctic). I. Mire grasslands. — *S. Afr. J. Antarct. Res.* 17: 117—132.
- Smith, V. R. (1987d): Chemical composition of precipitation at Marion Island (sub-Antarctic). — *Atm. Environ.* 21: 1159—1165.
- Snelgar, W. P., Green, T. G. A. & Wilkens, A. L. (1981): Carbon dioxide exchange in lichens: resistances to CO₂ uptake at different thallus water contents. — *New Phytol.* 88: 353—361.
- Tysiaczny, M. J. & Kershaw, K. A. (1979): Physiological-environmental interactions in lichens. VII. The environmental control of glucose movement from alga to fungus in *Peltigera canina* v. *praetextata* Hue. — *New Phytol.* 83: 137—146.
- Whitton, B. A. & Sinclair, C. (1975): Ecology of blue green algae. — *Sci Prog. (London)* 62: 429—446.