



714  
2017

# Berichte

zur Polar- und Meeresforschung

Reports on Polar and Marine Research

## The Expedition S0258/2 of the Research Vessel SONNE to the central Indian Ocean in 2017

Edited by

Wolfram Geissler

with contributions of the participants

Die Berichte zur Polar- und Meeresforschung werden vom Alfred-Wegener-Institut, Helmholtz-Zentrum für Polar- und Meeresforschung (AWI) in Bremerhaven, Deutschland, in Fortsetzung der vormaligen Berichte zur Polarforschung herausgegeben. Sie erscheinen in unregelmäßiger Abfolge.

Die Berichte zur Polar- und Meeresforschung enthalten Darstellungen und Ergebnisse der vom AWI selbst oder mit seiner Unterstützung durchgeführten Forschungsarbeiten in den Polargebieten und in den Meeren.

Die Publikationen umfassen Expeditionsberichte der vom AWI betriebenen Schiffe, Flugzeuge und Stationen, Forschungsergebnisse (inkl. Dissertationen) des Instituts und des Archivs für deutsche Polarforschung, sowie Abstracts und Proceedings von nationalen und internationalen Tagungen und Workshops des AWI.

Die Beiträge geben nicht notwendigerweise die Auffassung des AWI wider.

Herausgeber

Dr. Horst Bornemann

Redaktionelle Bearbeitung und Layout

Birgit Reimann

Alfred-Wegener-Institut  
Helmholtz-Zentrum für Polar- und Meeresforschung  
Am Handeshafen 12  
27570 Bremerhaven  
Germany

[www.awi.de](http://www.awi.de)  
[www.reports.awi.de](http://www.reports.awi.de)

Der Erstautor bzw. herausgebende Autor eines Bandes der Berichte zur Polar- und Meeresforschung versichert, dass er über alle Rechte am Werk verfügt und überträgt sämtliche Rechte auch im Namen seiner Koautoren an das AWI. Ein einfaches Nutzungsrecht verbleibt, wenn nicht anders angegeben, beim Autor (bei den Autoren). Das AWI beansprucht die Publikation der eingereichten Manuskripte über sein Repository ePIC (electronic Publication Information Center, s. Innenseite am Rückdeckel) mit optionalem print-on-demand.

The Reports on Polar and Marine Research are issued by the Alfred Wegener Institute, Helmholtz Centre for Polar and Marine Research (AWI) in Bremerhaven, Germany, succeeding the former Reports on Polar Research. They are published at irregular intervals.

The Reports on Polar and Marine Research contain presentations and results of research activities in polar regions and in the seas either carried out by the AWI or with its support.

Publications comprise expedition reports of the ships, aircrafts, and stations operated by the AWI, research results (incl. dissertations) of the Institute and the Archiv für deutsche Polarforschung, as well as abstracts and proceedings of national and international conferences and workshops of the AWI.

The papers contained in the Reports do not necessarily reflect the opinion of the AWI.

Editor

Dr. Horst Bornemann

Editorial editing and layout

Birgit Reimann

Alfred-Wegener-Institut  
Helmholtz-Zentrum für Polar- und Meeresforschung  
Am Handeshafen 12  
27570 Bremerhaven  
Germany

[www.awi.de](http://www.awi.de)  
[www.reports.awi.de](http://www.reports.awi.de)

The first or editing author of an issue of Reports on Polar and Marine Research ensures that he possesses all rights of the opus, and transfers all rights to the AWI, including those associated with the co-authors. The non-exclusive right of use (einfaches Nutzungsrecht) remains with the author unless stated otherwise. The AWI reserves the right to publish the submitted articles in its repository ePIC (electronic Publication Information Center, see inside page of verso) with the option to "print-on-demand".

*Titel: FS Sonne an der Nordpier im Hafen von Colombo (Foto: Wolfram Geissler, AWI)*

*Cover: RV Sonne at the North Pier in the port of Colombo (Photo: Wolfram Geissler, AWI)*

# **The Expedition SO258/2 of the Research Vessel SONNE to the central Indian Ocean in 2017**

---

**Edited by  
Wolfram Geissler  
with contributions of the participants**

**Please cite or link this publication using the identifiers  
hdl:10013/epic.52044 or <http://hdl.handle.net/10013/epic.52044> and  
[https://doi.org/10.2312/BzPM\\_0714\\_2017](https://doi.org/10.2312/BzPM_0714_2017)**

**ISSN 1866-3192**

**SO258/2**

**INGON  
The Indian - Antarctic Break-up Enigma**

**12 July 2017 - 17 August 2017  
Colombo - Colombo**

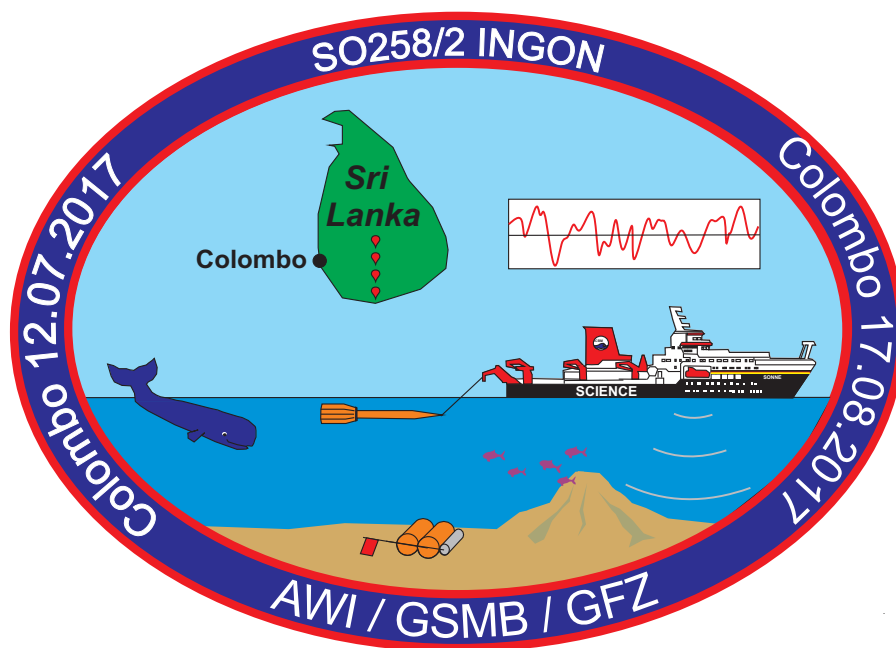

**Chief scientist  
Wolfram Geissler**

**Project coordinator  
Wilfried Jokat**

## **Contents**

<b>1.</b>	<b>Zusammenfassung / Cruise Summary</b>	<b>2</b>
<b>2.</b>	<b>Participants</b>	<b>4</b>
	2.1 Principal investigators for INCON	4
	2.2 Scientific party	4
	2.3 Ship's crew	6
<b>3.</b>	<b>Research Program</b>	<b>7</b>
<b>4.</b>	<b>Narrative of the Cruise</b>	<b>8</b>
<b>5.</b>	<b>Work Details and Preliminary Results</b>	<b>11</b>
	5.1 Magnetics	11
	5.2 Seismic profiling	20
	5.3 Hydro-acoustics	31
	5.4 Gravity	36
	5.5 Marine mammal observation	48
	5.6 Acoustic doppler current profiler (ADCP)	54
<b>6.</b>	<b>Data and Sample Storage and Availability</b>	<b>54</b>
<b>7.</b>	<b>Acknowledgements</b>	<b>55</b>
<b>8.</b>	<b>References</b>	<b>56</b>

## **Appendix**

<b>A.1</b>	<b>Station List</b>	<b>57</b>
------------	---------------------	-----------

## 1. ZUSAMMENFASSUNG / CRUISE SUMMARY

### ZUSAMMENFASSUNG

Die Fahrtabschnitte SO258/1 und SO258/2 des FS *Sonne* sind Bestandteil des Forschungsprojekts INGON, das in Kooperation zwischen dem Alfred-Wegener-Institut Helmholtz-Zentrum für Polar- und Meeresforschung in Bremerhaven und dem GEOMAR Helmholtz-Zentrum für Ozeanforschung in Kiel durchgeführt wird. Am Beispiel des Aufbruchs von Indien und der Antarktis vor etwa 130 Millionen Jahren, möchte SO258-INGON magmatische und tektonische Prozesse untersuchen, die zum Aufbruch von Kontinenten und der Entstehung ozeanischer Becken führen. Dies ist nicht nur eine interessante Fragestellung in der Grundlagenforschung, die zu einem besseren Verständnis des Systems Erde beiträgt, sondern liefert auch wichtige Daten zu den Wechselwirkungen zwischen magmatischen und vulkanischen Aktivitäten und ihres Einflusses auf Umwelt, Klima und Ökosysteme.

Es gibt viele offene Fragen, was die Abspaltung von Indien/Sri Lanka von der Antarktis während des Auseinanderbrechens von Gondwana angeht. Wann gab es die ersten Anzeichen für den Aufbruch? Wurde der Aufbruch ausgelöst durch einen „hotspot“ (Mantel-Plume), der zur Platznahme der Rajmahal Flutbasalte (Plume-Kopf) und zur Bildung des 85°E-Rückens (Plume-Stamm), eines der markanten Rückensysteme im Indischen Ozean, führte? Gab es die extrem hohen Driftraten von Indien/Sri Lanka bereits nach dem Aufbruch oder erst ab etwa 67 Ma, ausgelöst durch einen anderen Prozess? Die genaue Bestimmung des Zeitpunktes der schnellen Plattendrift (~18 cm/Jahr) ist wichtig zum Verständnis ihrer Ursachen. Um diese Fragen zu beantworten, wird ein genaues magnetisches Altersmodell für die ozeanische Kruste südlich von Sri Lanka benötigt, das den Zeitraum vom Aufbruch bis etwa ≤70 Ma abdeckt. Publierte kinematische Modelle variieren um mehr als 30 Millionen Jahre. Daher sind die ursächlichen magmatischen Prozesse bisher nicht bekannt. Bis heute wurde nur eine Stelle entlang des 85°E-Rückens beprobt (Afanasy-Nikitin-Unterseeberg). Es gibt zwei Altersdatierungen (79-73 Ma, ~ 55 Ma, Krishna *et al.*, 2014), aber die genaue Herkunft der Probe ist unklar. Die Proben vom Afanasy-Nikitin-Unterseeberg zeigen die höchste Anreicherung kontinenttypischer Isotopenverhältnisse von Gesteinen, die jemals vom Ozeanboden analysiert wurden. Die Herkunft dieser geochemischen Anomalien ist bisher nicht geklärt.

Das Hauptziel des Fahrabschnitts SO258/2 war es, die bekannten plattenkinematischen/geodynamischen Modelle für die Abspaltung von Indien/Sri Lanka von der Antarktis und die Driftrate der Indischen Platte mittels verschiedener geophysikalischer Verfahren (Magnetik, Seismik, Gravimetrie, Bathymetrie) zu testen. Dafür wurde die Struktur und Geometrie des Kontinent-Ozean-Übergangs südlich von Sri Lanka, die angrenzende ozeanische Kruste sowie die Struktur des 85°E-Rückens untersucht. Diese Untersuchungen folgten komplementären geochronologischen-geochemischen Studien vom GEOMAR Kiel, die auf dem Fahrtabschnitt SO258/1 durchgeführt wurden.

## SUMMARY

*Sonne* cruise SO258 is part of the research project INGON, which is a collaboration between the Alfred Wegener Institute Helmholtz Centre for Polar and Marine Research (AWI) in Bremerhaven and the GEOMAR Helmholtz Centre for Ocean Research in Kiel. Using the example of the India-Antarctica Breakup c. 130 m.y. ago, SO258 INGON aims to investigate magmatic and tectonic processes that trigger the breakup of continents and the formation of ocean basins. This is not only an important topic in basic research contributing to a better understanding of the Earth system but also provides important data on the relations between magmatic and volcanic activity and their influence on environment, climate, and ecological systems.

Many questions remain concerning the India/Sri Lanka separation from Antarctica during the break-up of Gondwana. When was the initiation of the breakup? Was it triggered by a hotspot, which generated the Rajmahal Trap basalts (plume head) and the 85°E ridge (plume tail), one of in total three prominent basement ridges in the Indian Ocean? Did the extremely rapid drift of India/Sri Lanka begin at breakup or instead at ~67 Ma triggered by a different process? Determination of the timing of the rapid motion (~18 cm/yr) has major implications for its cause. To answer these questions, obtaining an accurate magnetic model for Indian seafloor off Sri Lanka from initiation to ≤70 Myr is essential. Published kinematic models vary by more than 30 m.y. and therefore the related magmatic processes are unknown. To date, only a single locality along the 85°E Ridge (Afanasy Nikitin Seamount) has been sampled, but only two age dates (79-73 Ma, ~ 55 Ma, Krishna *et al.*, 2014) are available and the origin of the samples is unclear. The samples from Afanasy Nikitin Seamount, however, show the most enriched (continental-like) isotopic ratios of any rocks analyzed from the ocean basins thus far. The origin of this geochemical anomaly, however, is still unclear.

The major objective of SO258 Leg 2 INGON was testing current plate kinematic/ geodynamic models for the separation of India/ Sri Lanka from Antarctica and the rate of drift of the Indian plate by a combination of various geophysical methods (magnetics, seismics, gravity, bathymetry). In this context, the structure and geometry of the continent-ocean transition (COT) south of Sri Lanka, the adjacent oceanic crust, as well as the structure of the 85°E Ridge was investigated during cruise SO258 leg 2. These investigations were preceded on SO258 Leg 1 by complementary geochronological-geochemical studies conducted by the GEOMAR Kiel.

## 2. PARTICIPANTS



*Fig. 2.1: Scientific cruise participants of SO258/2. Photograph by Wolfgang Borchert.*

### 2.1 Principal investigators for INGON

Jokat, Wilfried	AWI (project coordinator)
Werner, Reinhard	GEOMAR
Geissler, Wolfram	AWI

### 2.2 Scientific party

Altenbernd, Tabea (Co-Chief Sc.)	Scientist, Geophysics	AWI
Behnke, Konrad	Student, Geophysics	AWI
Beniest, Anouk	Scientist, Geophysics	UPMC
Bridge, Marcus	Marine Mammal Observer	Gardline
Brotzer, Andreas	Student, Geophysics	AWI
Flenner, Dennis	Student, Geophysics	AWI
Fujii, Masakazu	Senior Scientist, Geophysics	NIPR
Geissler, Wolfram (Chief Scientist)	Senior Scientist, Geophysics	AWI
Goonewardena, Menaka	Marine Mammal Observer	GTWSC
Haas, Maximilian	Student, Geophysics	AWI



Hayes, Emma	Marine Mammal Observer	Gardline
Hiller, Marc	Student, Geophysics	AWI
Kapuge, Isuri	Student, Geophysics	UR
Kopsch, Konrad	Technician, Geophysics	ESYS
Krocker, Ralf	Senior Scientist, Geophysics	AWI
Lemke, David	Student Geophysics	AWI
Lensch, Norbert	Technician, Geophysics	AWI
Levchenko, Oleg	Senior Scientist, Geophysics	IO RAS
Lösing, Mareen	Student, Geophysics	AWI
Munasinghe, Tharanga	Scientist, Geophysics	GSMB
Nanayakkara, Nadee	Student, Geophysics	UR
Nawaratne, Sirinaga	Senior Scientist, Geophysics	UP
Perera, K.N.C.	Observer	SLN
Ratnayake, Dulap	Observer	NARA
Schröder, Patrick	Technician, Geophysics	GEOMAR
Zinow, Tim	Student, Geophysics	AWI

### 2.3 Organisations

AWI	Alfred Wegener Institute Helmholtz Centre for Polar and Marine Research, Section of Geophysics, Am Alten Hafen 26, 27568 Bremerhaven, Germany ( <a href="http://www.awi.de">http://www.awi.de</a> )
ESYS	ESYS GmbH, Schwedter Straße 34a, 10435 Berlin, Germany
GEOMAR	Helmholtz Centre for Ocean Research Kiel (GEOMAR), Wischhofstr. 1-3, 24148 Kiel, Germany ( <a href="http://www.geomar.de">http://www.geomar.de</a> )
Gardline	Gardline Geosurvey Limited, Endeavour House, Admiralty Road, Great Yarmouth, Norfolk, NR30 3NG, United Kingdom
GSMB	Geological Survey and Mines Bureau, 569, Epitamulla Road, Pitakotte, Sri Lanka
GTWSC	GT Water Sports Company (PVT)LTD, 71, Sri Dhamma Siddi Mawatha, Kandy, 20000, Sri Lanka
IO RAS	P.P. Shirshov Institute of Oceanology of the Russian Academy of Sciences, Nachimowskij prospekt 36, 117997 Moscow, Russia
NARA	National Aquatic Resources Research and Development Agency, National Hydrographic Office, Crow Island, Colombo 15, Sri Lanka
NIPR	National Institute of Polar Research, 10-3, Midori-cho, Tachikawa-shi, Tokyo 190-8518, Japan
SLN	Sri Lanka Navy, Naval Headquarters, Colombo, Sri Lanka
UP	University of Peradeniya, Galaha Rd, Peradeniya, 20400, Sri Lanka
UPMC	Université Pierre et Marie Curie, 4 Place Jussieu, Case – 129, 75252, Paris Cedex 5, France
UR	University of Ruhuna, Wellmadama, Matara, Sri Lanka

**2.4 Ship's crew**

Meyer, Oliver	Master
Birnbaum-Fekete, Tilo	Chief Mate
Hoffsommer, Lars	1 <sup>st</sup> Officer
Bücheler, Heinz-Ulrich	2 <sup>nd</sup> Officer
Hermesmeyer, Dieter	Chief Engineer
Genschow, Steffen	2 <sup>nd</sup> Engineer
Kasten, Stefan	2 <sup>nd</sup> Engineer
Dr. Schütte, Berthold	Ship's Doctor
Grossmann, Matthias	Chief Electronic Engineer
Meinecke, Stefan	Electronic Engineer
Borchert, Wolfgang	System Manager
Adam, Patrick	Electrician
Ovcharenko, Timur	Electrician
Bolik, Torsten	Fitter
Talpai, Matyas	Motorman
Bredlo, Björn-Alexander	MPC/Motorman
Blaurock, Andre	MPC/Motorman
Garnitz, Andre	1 <sup>st</sup> Cook
Lohmann, Christian	2 <sup>nd</sup> Cook
Lemm, Rene	1 <sup>st</sup> Steward
Yan, Jinghao	2 <sup>nd</sup> Steward
Kluge, Sylvia	2 <sup>nd</sup> Stewardess
Steep, Maik	2 <sup>nd</sup> Steward
Kraft, Jürgen	Boatswain
Heibeck, Frank	MPC/A.B.
Kruszona, Torsten	MPC/A.B.
Scholz, Oliver	MPC/A.B.
Fricke, Ingo	MPC/A.B.
Brüdigam, Benjamin	MPC/A.B.
Eidam, Oliver	MPC/A.B.
Gieske, Ralf	MPC/A.B.

### 3. RESEARCH PROGRAM

The major objective of this leg was testing current plate kinematic/geodynamic models for the separation of India from Antarctica and the rate of drift of the Indian plate by a combination of geophysical (leg 258/2) and petrological methods (leg 258/1). In this context, the structure and geometry of the continent-ocean transition (COT) south of Sri Lanka and the adjacent ocean crust, as well as the structure of the 85°E Ridge was investigated during cruise leg 258/2.

Knowing the geophysical parameters like crustal structure and age of oceanic crust will allow us to choose between different kinematic models for the separation of India/Sri Lanka from Antarctica. The margin off Sri Lanka is the only area to acquire first order information on the deeper structure of the COT for this sector of Gondwana. A revision/refinement of existing plate kinematic models can only be accomplished by a set of new high quality geophysical data in combination with geochronological and geochemical data. The central questions that had been addressed by the SO258/2 geophysics program are:

(1) What is the age of the ocean floor between Sri Lanka and the Afanasy Nikitin Seamount (ANS)? The systematic magnetic survey during SO258/2 allows us for the first time to set up a sound kinematic model for this part of the Indian/Sri Lanka break-up history, in combination with existing data from Antarctica. The new marine magnetic data will confirm or exclude the existence of Mesozoic magnetic anomalies south of Sri Lanka. Two additional lines that had been acquired to the south of the ANS allow us to extend our study to even younger seafloor generation and to test the proposed acceleration of India.

(2) What is the geometry and structure of the COT south of Sri Lanka? The SO258/2 seismic wide-angle data allow us to classify the type of margin (volcanic vs non-volcanic) and together with the marine magnetic data to test current kinematic models for the area.

(3) In conjunction with the geochronological/petrological/geochemical program during cruise leg 258/1, the deep seismic sounding profile across the 85°E Ridge was measured to determine its crustal thickness and to constrain if the ridge has a magmatic origin.

We acquired systematic ship-borne magnetic profiles in N-S direction within a corridor of ~140 km width to identify the magnetic signature of the oceanic/transitional crust south of Sri Lanka and further southward. Judging on the survey layout one has to keep in mind that the proposed fracture zones south of 1°S are not well constrained by satellite gravity data and the previously existing sparse magnetic data. Therefore, the exact position of these fracture zones is not well known. The same applies to the Mesozoic spreading anomalies just south of Sri Lanka. Neither their age determination nor the orientation is well constrained. The width of the survey was chosen to cover an area between two proposed Late Cretaceous fracture zones in the south.

Two deep seismic profiles were measured with up to 30 ocean bottom seismometers (OBS) to determine the crustal structure of the Sri Lanka COT and the 85°E Ridge. The N-S line was designed to image the landward onset of the COT and the onset of oceanic crust. The SE-NW line across the 85°E ridge north of the ANS was acquired to test, if the crustal thickness significantly differs from those of the adjacent oceanic crust. In case that the ridge is the result of a hotspot, we can expect thickened crust below this structure. Here, we wanted to investigate a "normal" part of the subdued 85°E Ridge and not the crust below the ANS, which most likely is the consequence of additional excessive volcanism. Seismic recording stations (land stations) were also deployed onshore Sri Lanka to better image the COT and also parts of the unstretched continental crust. Beside magnetic and seismic measurement also gravity and hydro-acoustic data was acquired.

## 4. NARRATIVE OF THE CRUISE

*Sonne* Cruise SO258 leg 2 started in Colombo, Sri Lanka (Fig. 4.1). Already on July 9, some members of the scientific party visited the ship that had arrived in the morning and began with the installation of the gravity meter. On Monday, July 10, a pre-cruise meeting was held at the Foreign Affairs Ministry of Colombo, organized by the National Ocean Affairs Committee, to discuss the objectives of the cruise and related more technical issues. In the meantime, the first parts of the equipment were unloaded from the containers. In the course of July 11, the SO258 leg 2 scientific party embarked *Sonne*. The scientific party continued with setting-up the laboratories and preparations of the equipment. *Sonne* set sail in the morning of July 12.

Already in the late afternoon of July 12 we reached our first scientific station. The first cast was a CTD to measure temperature and conductivity within the water column. These data were used to calculate the speed of sound in the water to correct the echo sounder system for refraction. Afterwards the release units of the ocean-bottom seismometers (OBS) were tested successfully. These tests continued until the early morning of July 13, 2017. After we had passed the sea route at Dondra Head, the towed magnetic system was deployed and systematic measurements started along the first profile at 07:30 LT. The fixed three-component fluxgate magnetometer system of our Japanese cooperation partners already acquired data since we left the harbor of Colombo. The systematic survey of the Earth's magnetic field to the south of Sri Lanka had the highest priority during cruise SO258 leg 2. On July 14, we passed the equator for the first time. A first expendable sound velocity probe was deployed to update the sound velocity profile necessary for the echo sounders. Since the profile was similar to the first measured profile, no adjustments had been applied. In the morning of July 15, magnetic measurements had to be interrupted unexpectedly, because the towed sensor had to be changed due to technical problems. In the afternoon of July 15, a second expendable CTD was deployed. Afterwards, *Sonne* did double loops ("8" turn) to calibrate the fixed magnetometer system. Using data recorded on the calibration loops allow correcting for the influence of the magnetic field of the vessel. Since we left the harbor, three marine mammal observers investigated what kind and numbers of animals were present within our study area. First sightings included whales, dolphins, whale sharks, turtles and birds. These first observations were used to adjust the mitigation procedures for the seismic measurements.

In the afternoon of July 17, the southernmost point of the magnetic profile slightly south of 11° S was reached. On the way to the south the weather had become worse. A strong high-pressure field south of our working area was responsible for wind up to strength of Beaufort 9 and high waves. It forced us to turn to the East and go to our second magnetic profile along 81° E. In the night towards July 21, the magnetic measurements with the towed system were stopped at 3° N. The tow fish was recovered. The seismic team started to deploy 30 ocean-bottom seismometers (OBS) along the northern profile section up to the southern shelf break of Sri Lanka. More or less every 60 minutes, the next deployment site was reached. Early in the morning of July 22, the last OBSs were deployed in the area of the Traffic Separation scheme and north of it. At that time, there were not only large container carrier, war ships and tanker vessels, but also many small fisher boats. The nautical officers had to carefully navigate *Sonne* through all that traffic. After the deployment of the last OBS, the vessel went slightly to the east to reach the deployment position for air guns and the magnetometer. Going with slow speed against the current, the deployments went without problems. Unfortunately, the 3,000 m long hydrophone cable (streamer) could not be prepared in time to be used along the first profile. Already before and during the deployment, whales, in most cases pygmy blue whales, visited us.

Just after the air guns were at full power and the first seismic profile started, one whale surfaced close to the vessel. According to the mitigation plan the air guns had to be stopped immediately. *Sonne* proceeded on profile towards the south throughout the traffic separation zone without a seismic source signal. After a defined period of quiescence, the air guns were activated a

second time in ramp-up mode with increasing signal strength. Since no whale surfaced in the vicinity of the vessel again, the seismic measurements could be continued after reaching full power. After two days of continuous profiling along the 81<sup>st</sup> meridian, we arrived at the southern end of the profile in the morning of July 24 at 2° 26' N. After the towed magnetometer and the air gun clusters were recovered, the recovery of OBSs started. With only a few exceptions, recovery of the instruments went very well and fast due to good weather conditions and sea state. Within two days *Sonne* reached the waters south of Sri Lanka again. Towards the coast, strong currents shifted the recovery position of the instruments eastwards. In the evening of July 26, we were again accompanied by pygmy blue whales during the recovery of the last OBS close to the coast of Sri Lanka. The magnetic survey was continued during the remaining days of the third week. There was only a short break because of a technical test of one of the sensors.

At the beginning of the fourth week *Sonne* again followed a northern course to measure the Earth's magnetic field along the third magnetic profile. Without any disturbances *Sonne* reached the shelf waters south of Sri Lanka in the afternoon of July 31. This time the weather and sea were rougher. In the morning of August 1, the towed magnetometer system was recovered to start with the deployment of 21 OBS along the second seismic refraction profile. In the meantime, the preparations for the deployment of the 3,000-m long hydrophone cable (streamer) could be finalized. In the morning of August 2, the last of the 21 OBS was on its way to the seafloor. *Sonne* went slightly eastward to start the deployment of the streamer, the airguns and at last the magnetometer. In the following one and a half days, the second seismic profile was measured towards NW, crossing all the OBS positions without any interruptions. Recovery of the towed gears and also the OBS started in the early morning of August 4. The weather had become worse during the last couple of days. Beside stronger wind and increased sea state, we also got heavy rainfalls at the vessel from time to time. During the rainfalls, the wind strength increased from Beaufort 6 or 7 up to 9 for short intervals. But shortly after, the sun was shining again. Since the *Sonne* runs stable within the sea, all planned actions and measurements could be carried out. Till August 6 *Sonne* again sailed on SE course to recover OBS. Although the weather was quite rough and made the recoveries more difficult, the experienced crew was able to bring all instruments safely home. Unfortunately, we failed at one OBS station to set communication with the release unit at the seafloor.

The fifth week was fully dedicated to the measurements of the Earth's magnetic field along the planned N-S profiles using both the towed and fixed magnetometer systems. In order to run all along the remaining many profile kilometers, *Sonne* went on full speed from now on. In the early morning of August 9, close to 3° S, an expendable sound velocity probe was deployed again to validate the refraction correction of the hydro-acoustic systems. On August 10, decision was made to continue with magnetic measurements until the very end of the cruise. Unfortunately, there was not enough time left to measure another seismic profile.

In the very early morning of August 12, a severe problem with the towed magnetometer system occurred that could not be fixed on board. From this time on, only the fluxgate magnetometer system was in operation, together with the gravity meter and the echo sounders. The weather during the last week changed very often. Sudden weather changes from sunny weather to heavy rainfalls occurred several times during the day. Wind strength ranged from 5 to 7. Also, the heights of the waves increased temporarily, mostly in the southern part of our survey area.

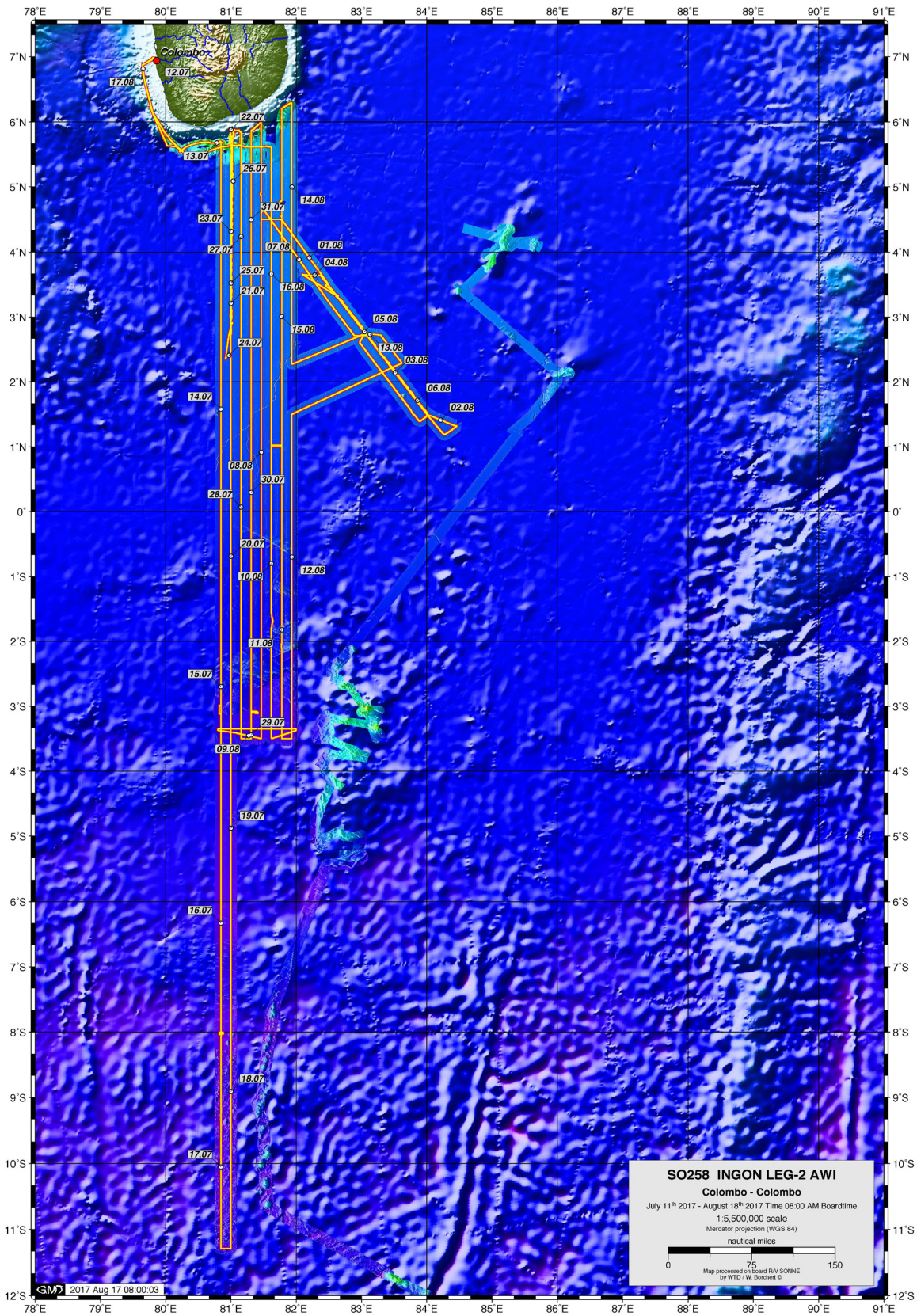

Fig. 4.1: Cruise track. Map prepared by Wolfgang Borchert.

At the beginning of the sixth week, *Sonne* reached again the shelf break southeast of Sri Lanka on August 14 at noon. It was again a great opportunity for our marine mammal observers to spot pygmy blue whales. Scientific party members that were not scheduled for watches were busy with packing all the scientific equipment. All devices were dismantled and packed into boxes. Finally, the containers could be stowed. On August 15 and 16 we completed the magnetic survey grid with the missing northern parts of two N-S profiles. All devices still in operation worked very well. Scientific data acquisition was finished August 16 at 23:00 LT. After a short transit from the last scientific profile, *Sonne* reached the pilot station at the entrance to the port of Colombo in the morning of August 17 around eight o'clock. The sun had just risen above the city. With a slight delay, the pilot together with the help of a tug guided *Sonne* towards the North Pier. The vessel finally arrived at the pier at eleven o'clock. After all scientific equipment, 5 containers and the big streamer winch, was taken from board, the gravity tie measurements were carried out beside the vessel and at known localities in Colombo, using a mobile gravity meter in the evening of August 17. A first group of scientist had already disembarked in the afternoon. The remaining members of the scientific party disembarked during August 18 and 19.

In the morning of August 18, a post-cruise meeting took place at the Foreign Affairs Ministry of Colombo, organized by the National Ocean Affairs Committee, to inform about the cruise and first preliminary results and discuss plans for the future. Employees of the German Embassy visited *Sonne* in the afternoon. Students of the universities Peradeniya and Ruhuna got a guided tour on the vessel in the morning of August 19. In the evening, the Ambassador of the Federal Republic of Germany in Sri Lanka, H. E. Jörn Rohde, invited for a reception onboard *Sonne*.

## 5. WORK DETAILS AND PRELIMINARY RESULTS

### 5.1 Magnetics

Wolfram Geissler <sup>1</sup> , Masakazu Fujii <sup>2</sup> , Conrad	<sup>1</sup> AWI
Kopsch <sup>3</sup> , Sirinaga Nawaratne <sup>4</sup>	<sup>2</sup> NIPR
	<sup>3</sup> ESYS
	<sup>4</sup> UP

We conducted magnetic field survey for detecting magnetic anomalies off Sri Lanka. The surveyed area extends from 6° N to 11° S, and 81° E to 84°E in order to cover at least anomaly chron C27 for younger seafloor, the continent-ocean-transition zone south of Sri Lanka and the adjacent old Mesozoic seafloor.

We used two different types of magnetics sensors (Fig. 5.1.1 and 5.1.2): a towed SeaSpy2 (Marine Magnetics) and a shipboard three-component magnetometer (STCM; SFG-1211, Tierra Technica, Japan). To study weak seafloor magnetic anomalies, it is important to minimize and compensate for transient signals generated in the magnetosphere and ionosphere as well as temporary, induced and permanent effects of the vessel.

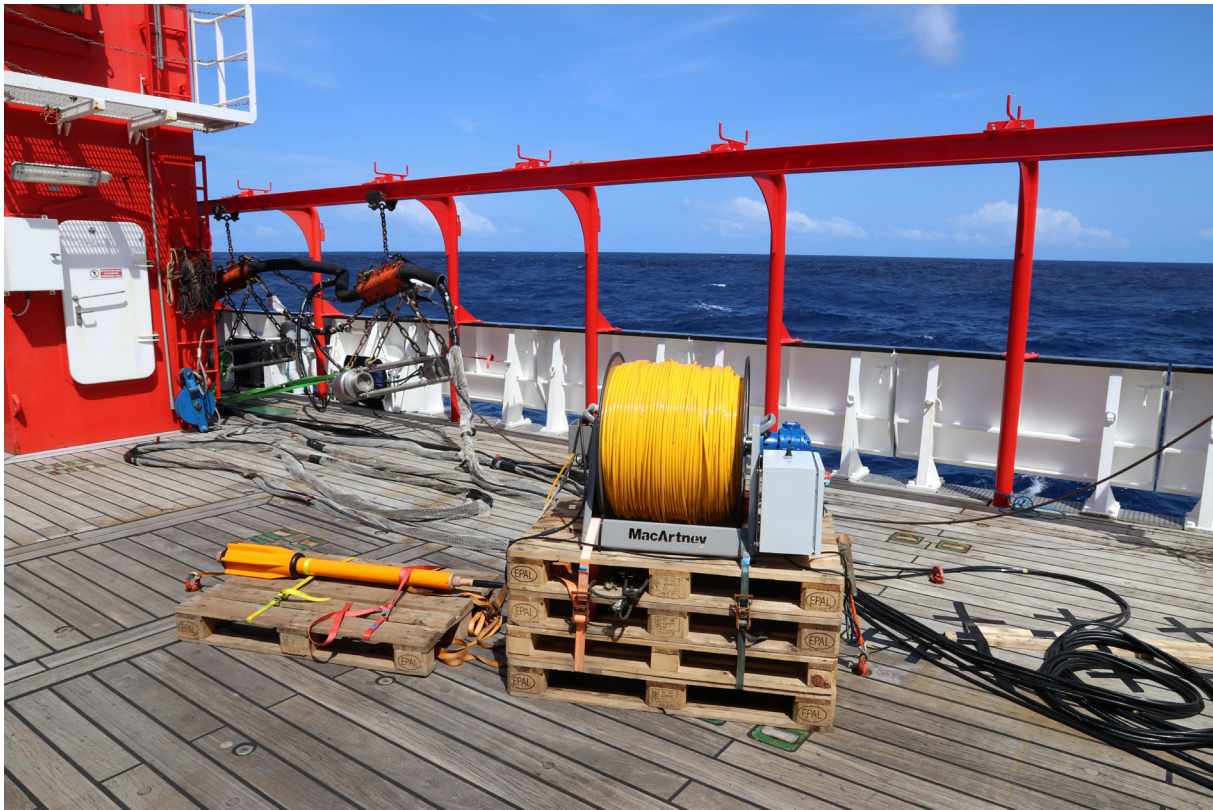

Fig. 5.1.1: Towed magnetometer fish with cable winch.

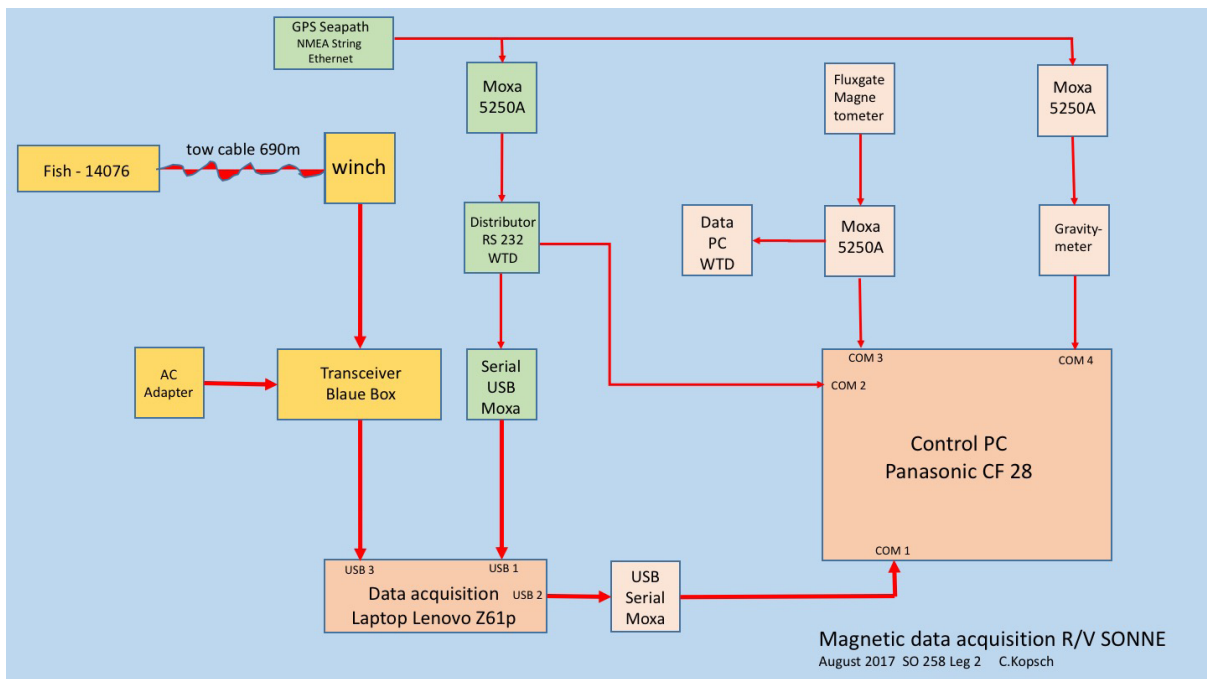
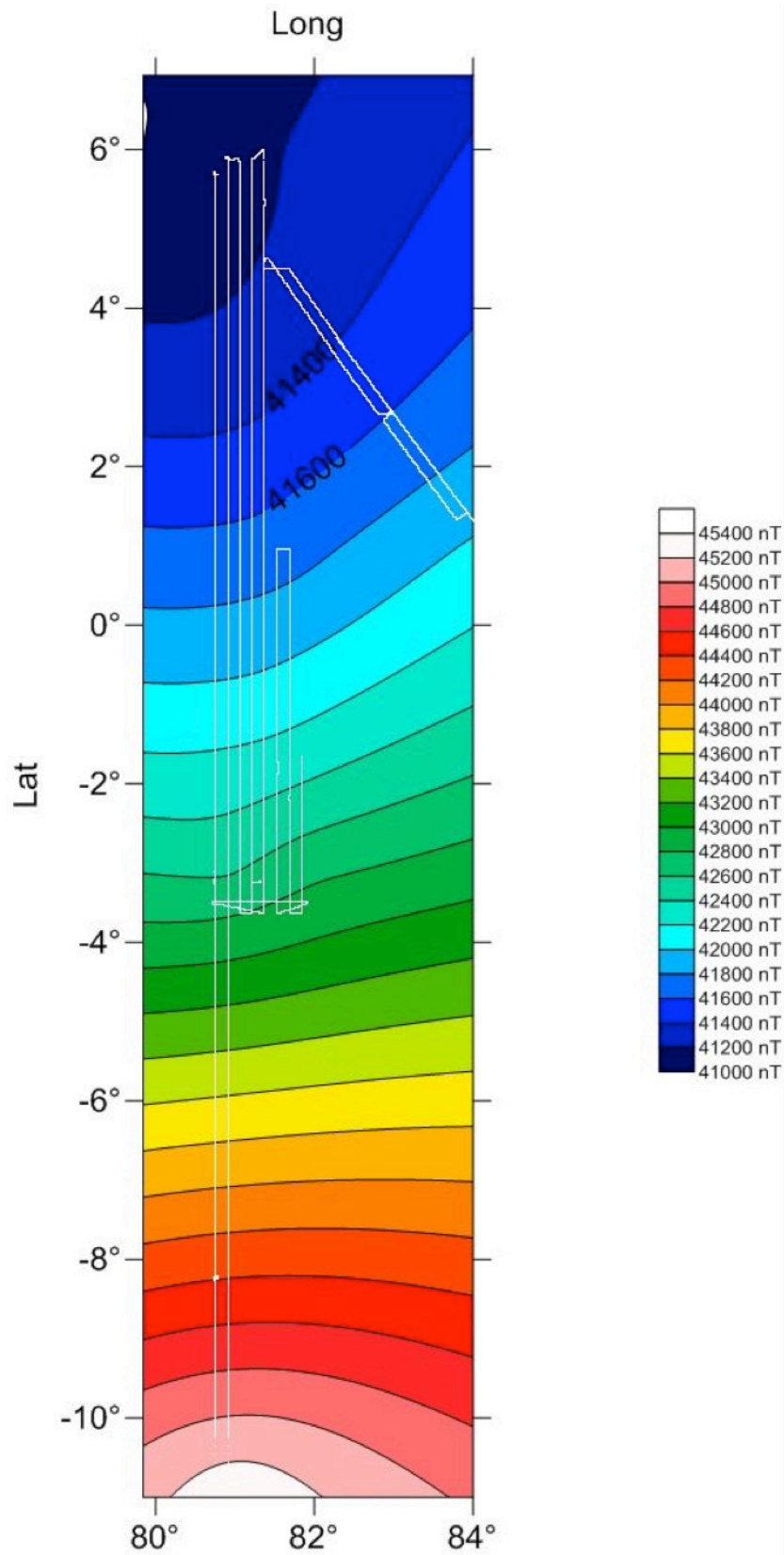

Fig. 5.1.2: Towed magnetometer system setup.



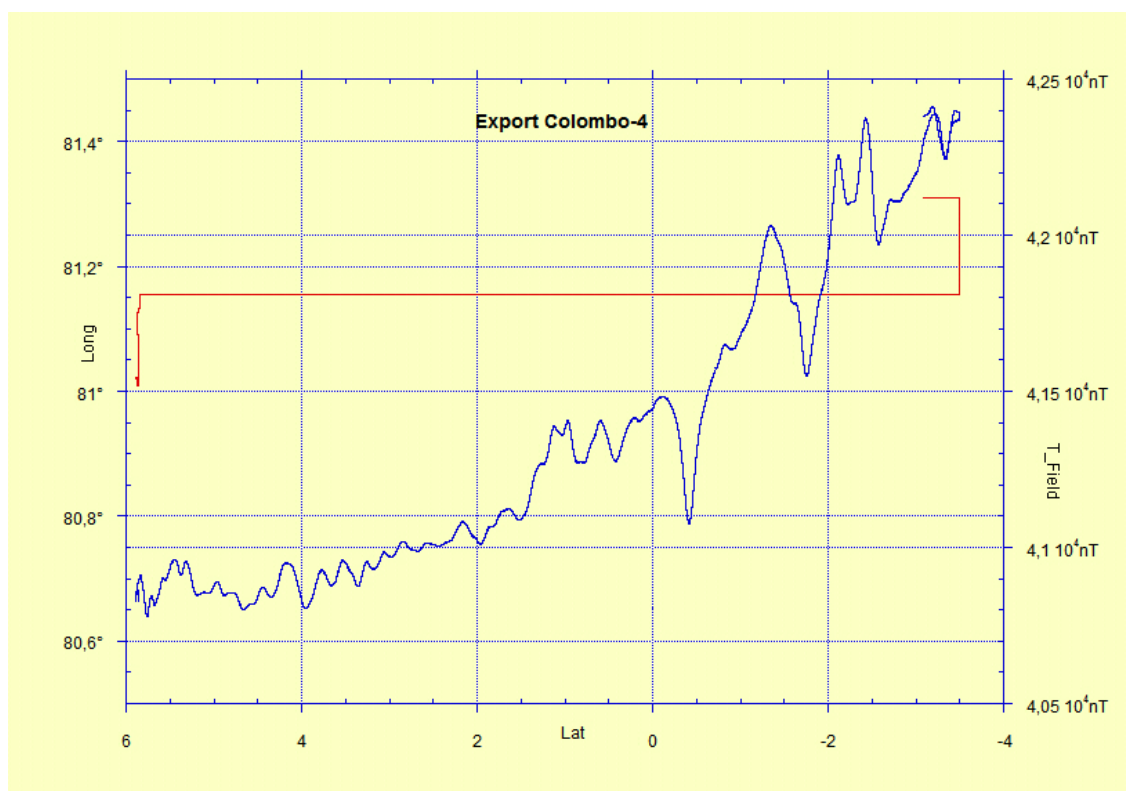

*Fig. 5.1.3: IGRF12 in the study area with location of measurements using the towed magnetometer system.*

### 5.1.1 Towed magnetometer

The SeaSpy2 magnetometer is a proton magnetometer and makes use of the Overhauser effect. It measures the total field intensity. The magnetic anomalies can be calculated by subtracting the reference field (IGRF12, Fig. 5.1.3). The IGRF12 reference field consists of coefficients that describe the Earth's magnetic field in 2015 and coefficients that describe changes in the following years. After subtracting the reference field, the measurements might be still disturbed by magnetic field variations.

To acquire magnetic data void of field variations, a longitudinal gradiometer system of two sensors (distance 50 m) is normally used. Unfortunately, our rear fish did not work properly. Therefore, we had to use the front fish as a single magnetometer. It was towed 690 m behind the vessel. Due to the long distance between sensor and vessel, there is no need to correct for any magnetic signals caused by the vessel itself.



**Fig. 5.1.4:** Data example from the towed magnetometer system. Red line, longitude; blue line, total intensity of the magnetic field.

### 5.1.2 Shipboard three-component magnetometer

The shipboard magnetometer system consists of a three-axes fluxgate magnetic sensor, ring-laser gyro (Nihon Koku-densi Kogyo, Japan), GPS sensor, controller, and a laptop computer for recording. The fluxgate and GPS sensors were fixed rigidly to the roof deck of *Sonne* (Fig. 5.1.5). The gyro, controller, and laptop were installed on deck 9 laboratory (Fig. 5.1.5). Both vector magnetic data and ship attitude (heading, pitch, and roll) data were collected at sampling rate of 8-Hz. The GPS time, longitude, and latitude were measured every second. These data were merged by the controller, and exported as ASCII text format through a serial port. The data was recorded by both the laptop of the STCM and another backup laptop which obtained data via a ship server in deck 3 (lab. 339).

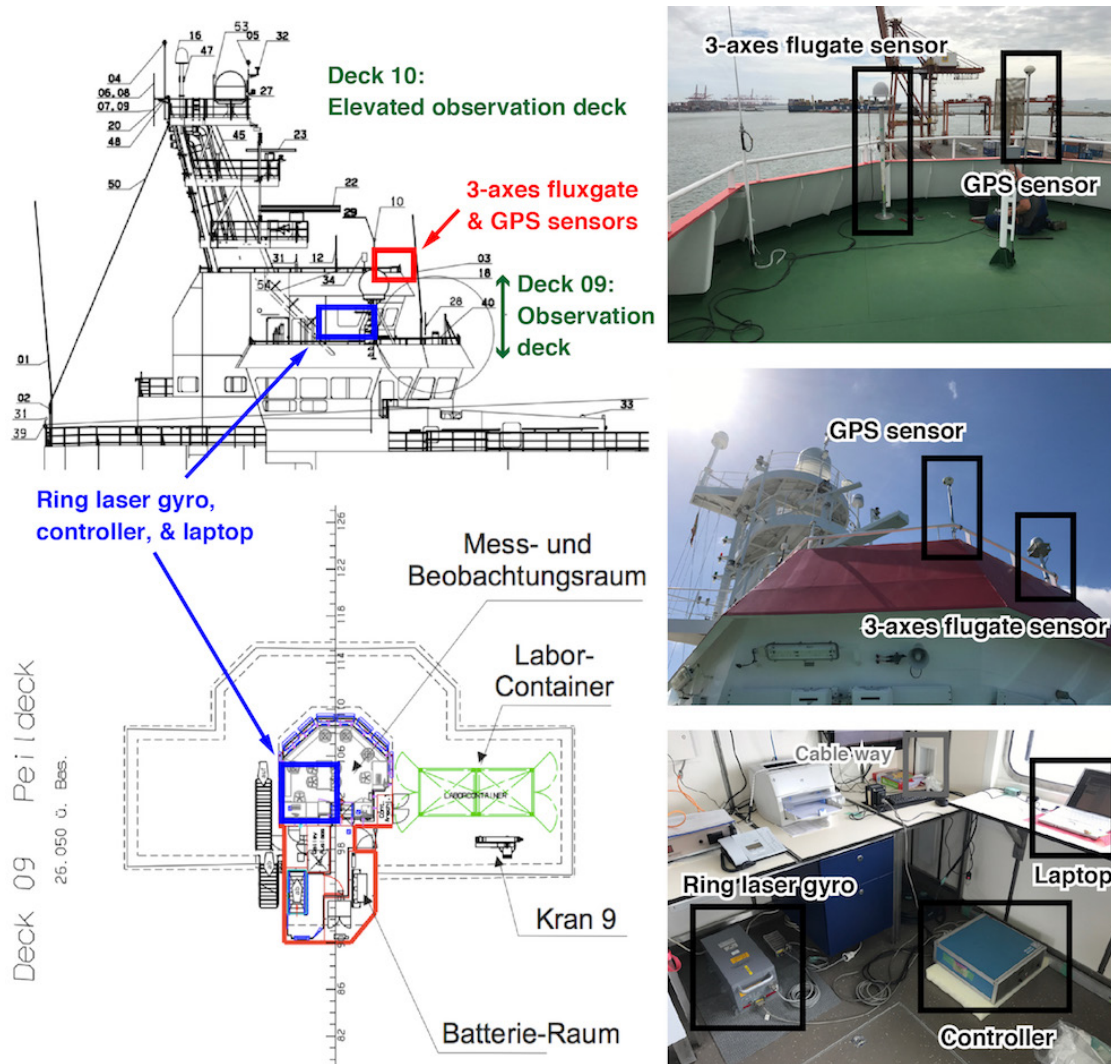
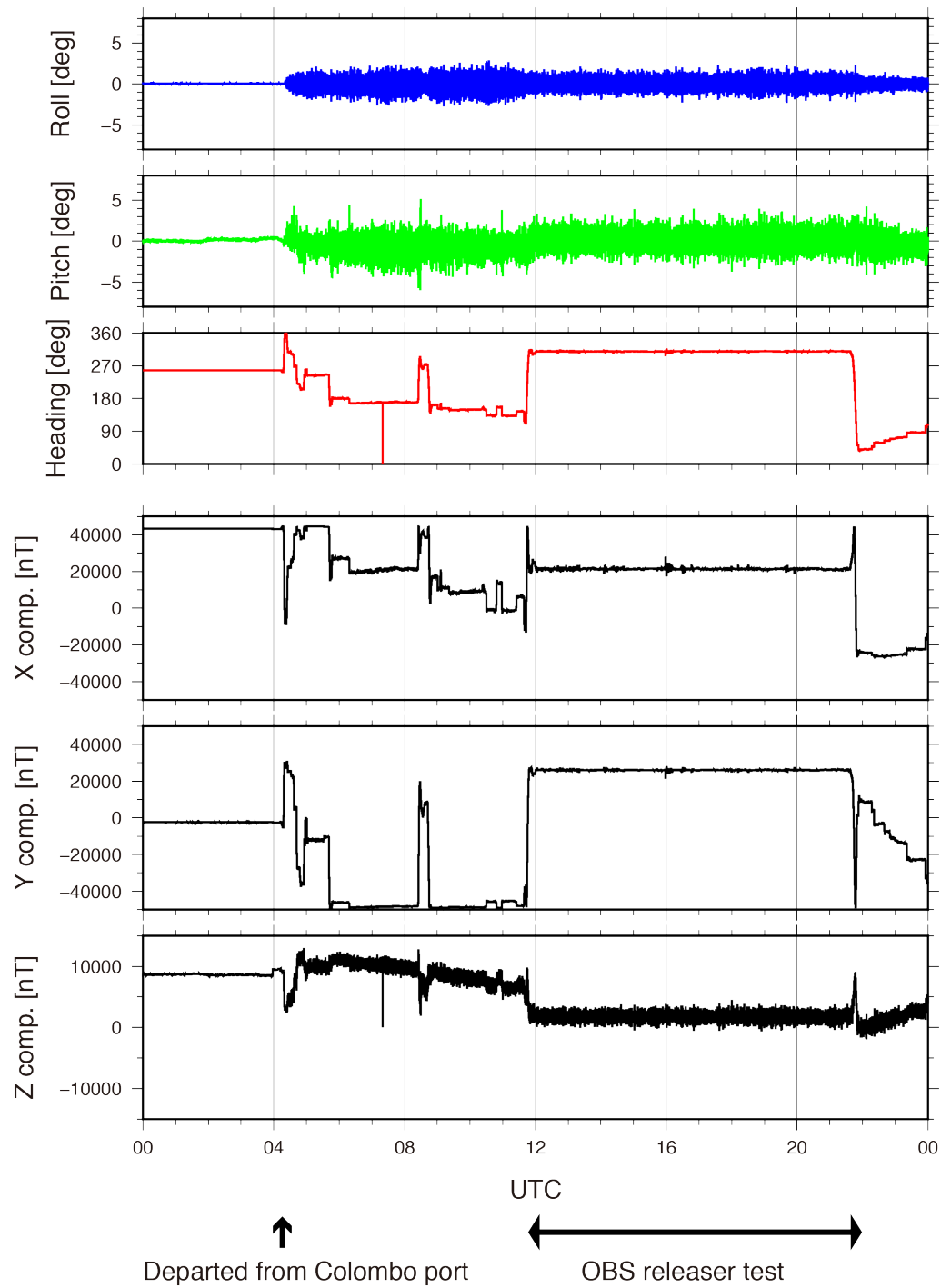

Fig. 5.1.5: Shipboard three components magnetometer system.

The three components of geomagnetic fields were successfully measured along the survey tracks reaching approximately 6,000 miles (see raw data example shown in Fig. 5.1.6). The system stopped recording from 13:08 on July 17 to 03:15 on July 18 (UTC) due to a computer problem. Survey lines consist of two 1,000-mile N–S tracks, six 600-mile N–S tracks, two 250-mile NW–SE tracks, and two 100-mile SW–NE tracks, as well as short tie lines. The survey lines crossed each other at ten locations. The ship speed was generally 10–12 kt, but reduced to 4–5 kt during seismic data acquisition.

In order to calibrate the effect of the vehicle magnetization, 8-figure turns were conducted three times at  $\sim 8^{\circ}\text{S}$  on July 16,  $\sim 4^{\circ}\text{N}$  on July 21, and  $\sim 3^{\circ}\text{S}$  on July 29 (Figs. 5.1.7, 5.1.8 and 5.1.9). Both the induced magnetization vector, expressed as the magnetic susceptibility tensor (nine coefficients), and the remanent magnetization vector (three coefficients) of the vehicle were estimated with least square inversion based on observation equation of *Isezaki* [1986]. The coefficients were estimated using all data merged with each 8-figure turn. The three components of magnetic anomaly were then calculated by removing the regional geomagnetic field (approximated by the International Geomagnetic Reference Field, IGRF [IAGA Working Group V-MOD, 2010]).

## STCM rawdata, July 12 2017, SONNE258/2



**Figure 5.1.6:** Raw data of the shipboard three components magnetometer (STCM). Ship attitude (roll, pitch, heading) and three components of magnetic field are shown in time series.

8-figure turn, July 16 2017, SONNE258/2

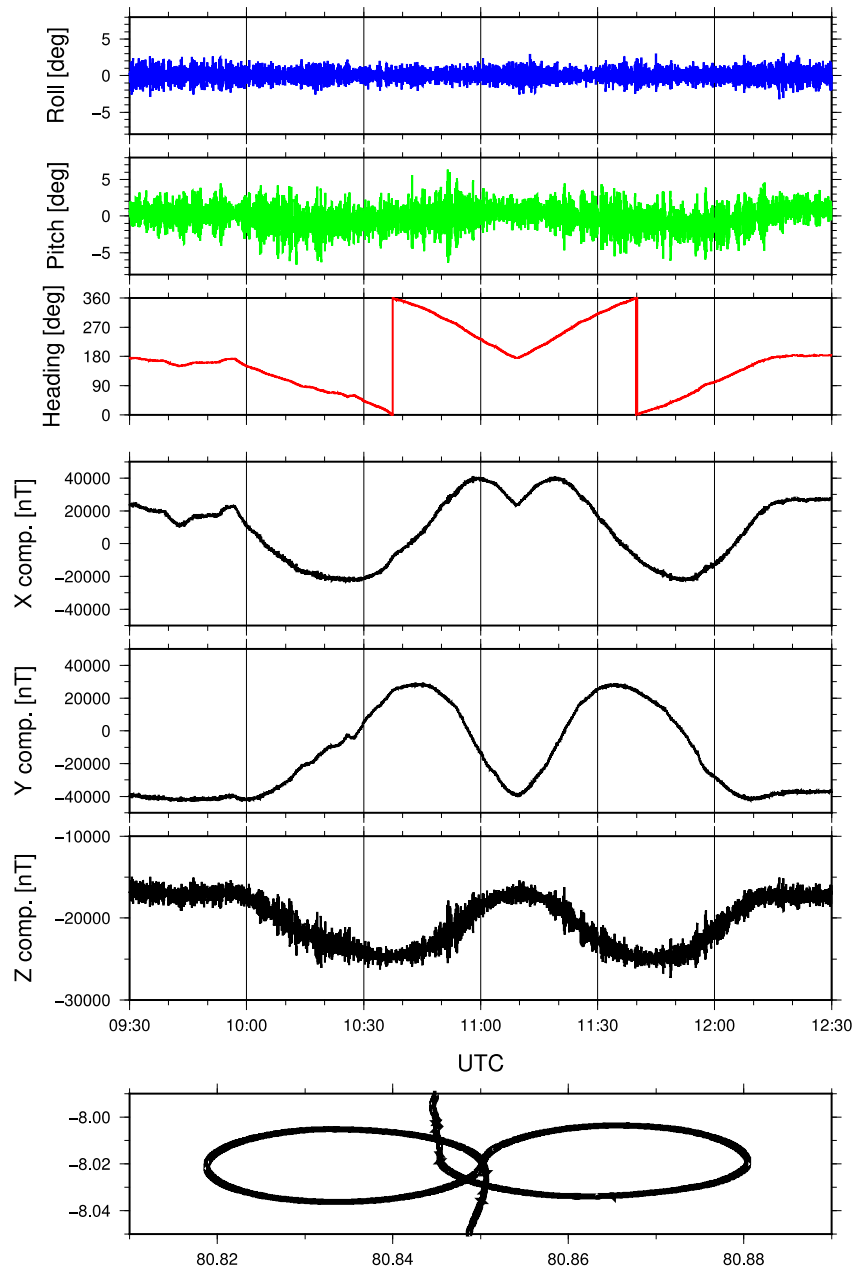

**Fig. 5.1.7:** The shipboard three components magnetometer (STCM) data during 8-figure turn conducted for sensor calibration. Ship attitude (roll, pitch, heading) and three components of magnetic field are shown in time series.

8-figure turn, July 21 2017, SONNE258/2

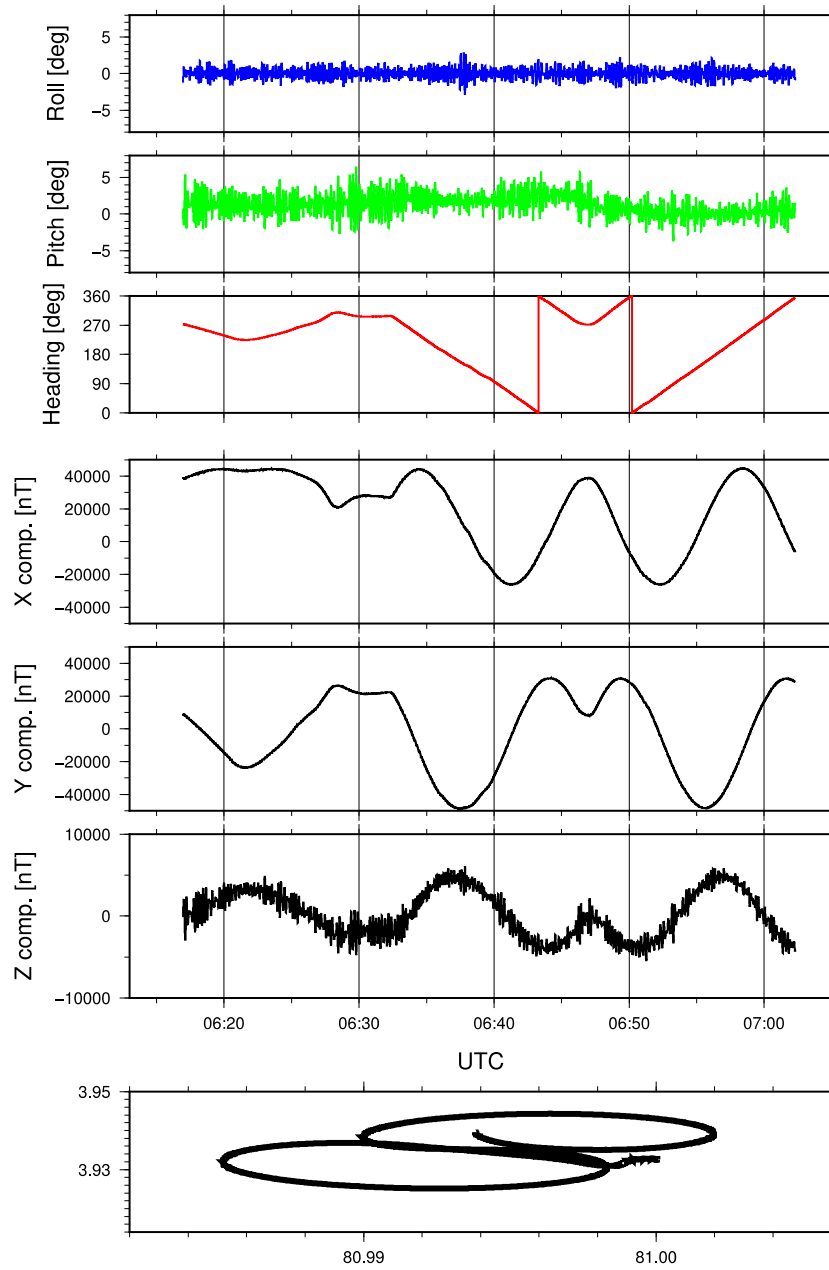

**Fig. 5.1.8:** The shipboard three components magnetometer (STCM) data during 8-figure turn conducted for sensor calibration. Ship attitude (roll, pitch, heading) and three components of magnetic field are shown in time series.

## 8-figure turn, July 29 2017, SONNE258/2

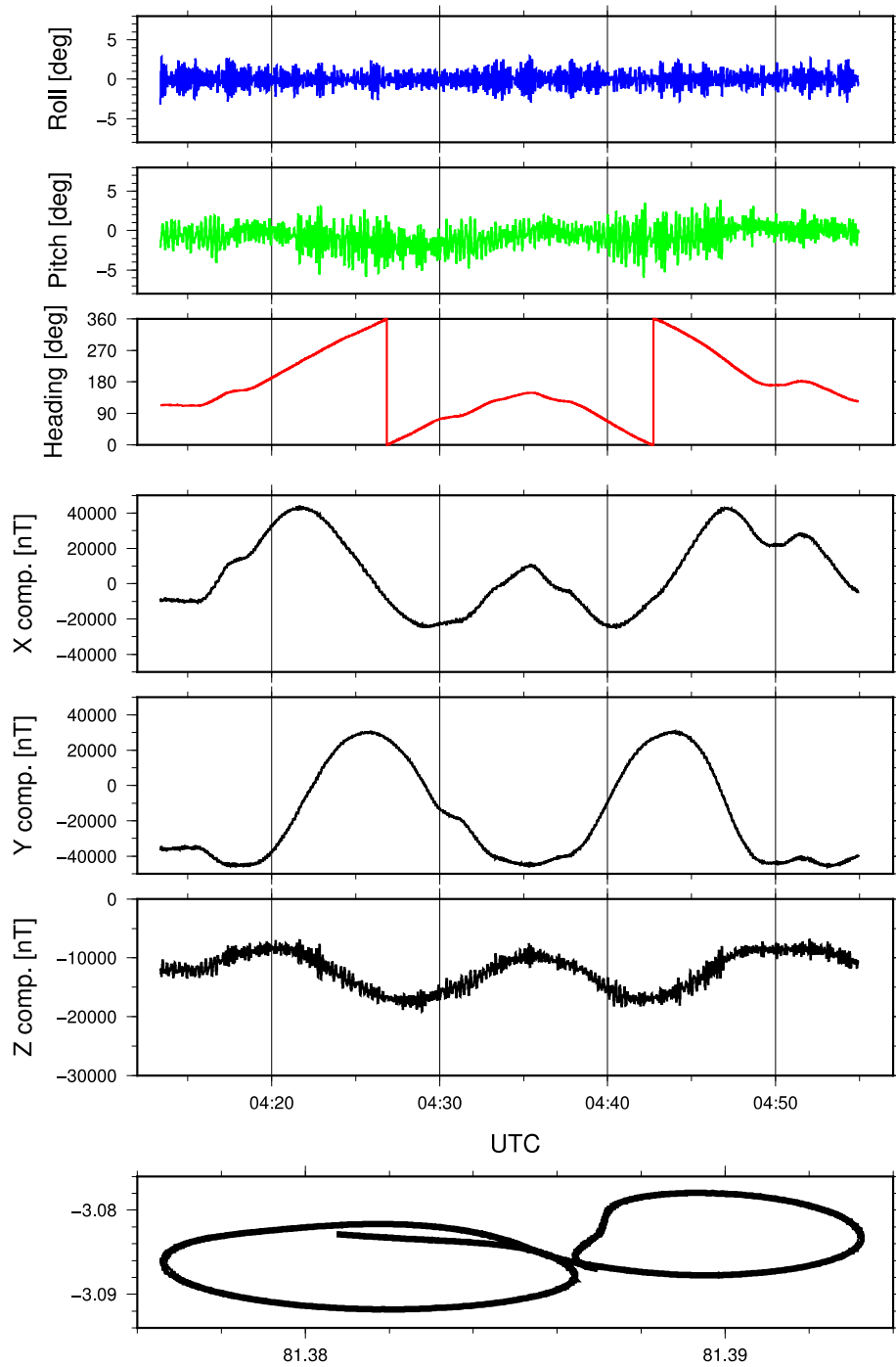

**Fig. 5.1.9:** The shipboard three components magnetometer (STCM) data during 8-figure turn conducted for sensor calibration. Ship attitude (roll, pitch, heading) and three components of magnetic field are shown in time series.

## 5.2 Seismic profiling

Tabea Altenbernd <sup>1</sup> , Wolfram Geissler <sup>1</sup> , Conrad Kopsch <sup>2</sup> , Norbert Lensch <sup>1</sup> , Patrick Schröder <sup>2</sup> , Marc Hiller <sup>1</sup> , Anouk Beniest <sup>3</sup> , Andreas Brotzer <sup>1</sup> , Sirinaga Nawaratne <sup>5</sup> , Tharanga Munasinghe <sup>6</sup> , Nuwan Perrera <sup>7</sup> , Konrad Behnke <sup>1</sup> , Dennis Flenner <sup>1</sup> , Maximilian Haas <sup>1</sup> , David Lemke <sup>1</sup> , Mareen Lösing <sup>1</sup> , Tim Zinow <sup>1</sup> , Christian Haberland <sup>8</sup> (not on board), Nalin de Silva <sup>6</sup> (not on board), Mahinda Seneviratne <sup>6</sup> (not on board)	<sup>1</sup> AWI <sup>2</sup> ESYS <sup>3</sup> GEOMAR <sup>4</sup> UPMC <sup>5</sup> UP <sup>6</sup> GSMB <sup>7</sup> SLN <sup>8</sup> GFZ Potsdam
---	---

Seismic refraction experiments were conducted along two profiles to investigate the crustal structure of the region (Fig. 5.2.1). The first profile AWI-20170300 extends in N-S direction along 81°E from the central part of Sri Lanka to the deep-sea area of the Indian Ocean. Ocean Bottom Seismometers (OBS) and land stations were deployed to acquire wide angle reflection and refraction data onshore and offshore. Based on that data, the P-wave and S-wave velocity structure of the sub-surface can be investigated. This way, the continent-ocean transition (COT) south of Sri Lanka and the onset, structure and geometry of the adjacent oceanic crust can be studied. Since the multi-channel seismic reflection (MCS) system was not operating at that time, we could not study the sedimentary cover by reflection imaging. The second profile AWI-20170400 extends in a NW-SE direction and crosses the proposed prolongation of the 85°E Ridge. The location of the profile was chosen to examine the crustal structure of the ridge and its surrounding crust. Along this profile we could also use the MCS technique to image the sedimentary layers and the structure of the sub-sedimentary basement and internal crustal reflections. Additionally, we also measured seismic reflection data along the short profile 20170390, approaching towards profile 20170400. The basic principles of refraction- and reflection seismic data acquisition are explained in Fig. 5.2.2.

### 5.2.1 Seismic source, triggering and timing

Eight G-Guns were used as seismic source for the refraction seismic experiments. Two clusters of 2x2 guns each were towed at a distance of 40 m behind the ship's stern and at a depth of 10 m. Every gun had a volume of 520 cubic inch, which results in a total volume of 4,160 cubic inch (68 l). The shot interval was 60 s. The trigger time was given by a Meinberg GPS clock. The system was operated during the entire seismic survey at a pressure of 200 bar and worked without major problems. Figure 5.2.4 shows the setup of the seismic system.

In compliance with the regulation for the protection of marine mammals, we gradually increased the number of operating airguns over an interval of 20 to 40 minutes (soft start) at the beginning of every survey and after shot gaps due to the potential presence of marine mammals.

### 5.2.2 Offshore seismic refraction data acquisition and processing

During the cruise, we used three different types of OBS systems for the offshore data acquisition of refraction seismic data. AWI contributed 12 LOBSTER systems (Fig. 5.2.5a) and 2 NAMMU systems (Fig. 5.2.5b) manufactured by K.U.M. (Umwelt- und Meerestechnik Kiel GmbH). These OBS belong to the AWI-run DEPAS pool (German Instrument Pool for Amphibian Seismology) and were equipped with a 6d6-recorder manufactured by K.U.M. Additionally, 20 OBS systems owned by GEOMAR (Fig. 5.2.5c) were used. These OBS systems were equipped with recorders manufactured by GEOMAR (Geolog recorder) or Sercel.



In general, all OBS systems consist of flotation units towed to a titanium frame, a pressure cylinder containing the data logger and batteries, a hydrophone, a flash and radio beacon, and a flag (Fig. 5.2.5a). All AWI OBS were equipped with a 3-component seismometer type TrilliumCompact (manufactured by Nanometrics). The GEOMAR OBS were equipped with a geophone instead of a seismometer. Different anchor weights were used for the different OBS systems. The anchor weight makes sure that the OBS sinks to the seafloor after the deployment and was connected to the OBS frame via an acoustic releaser, type KUMquat.

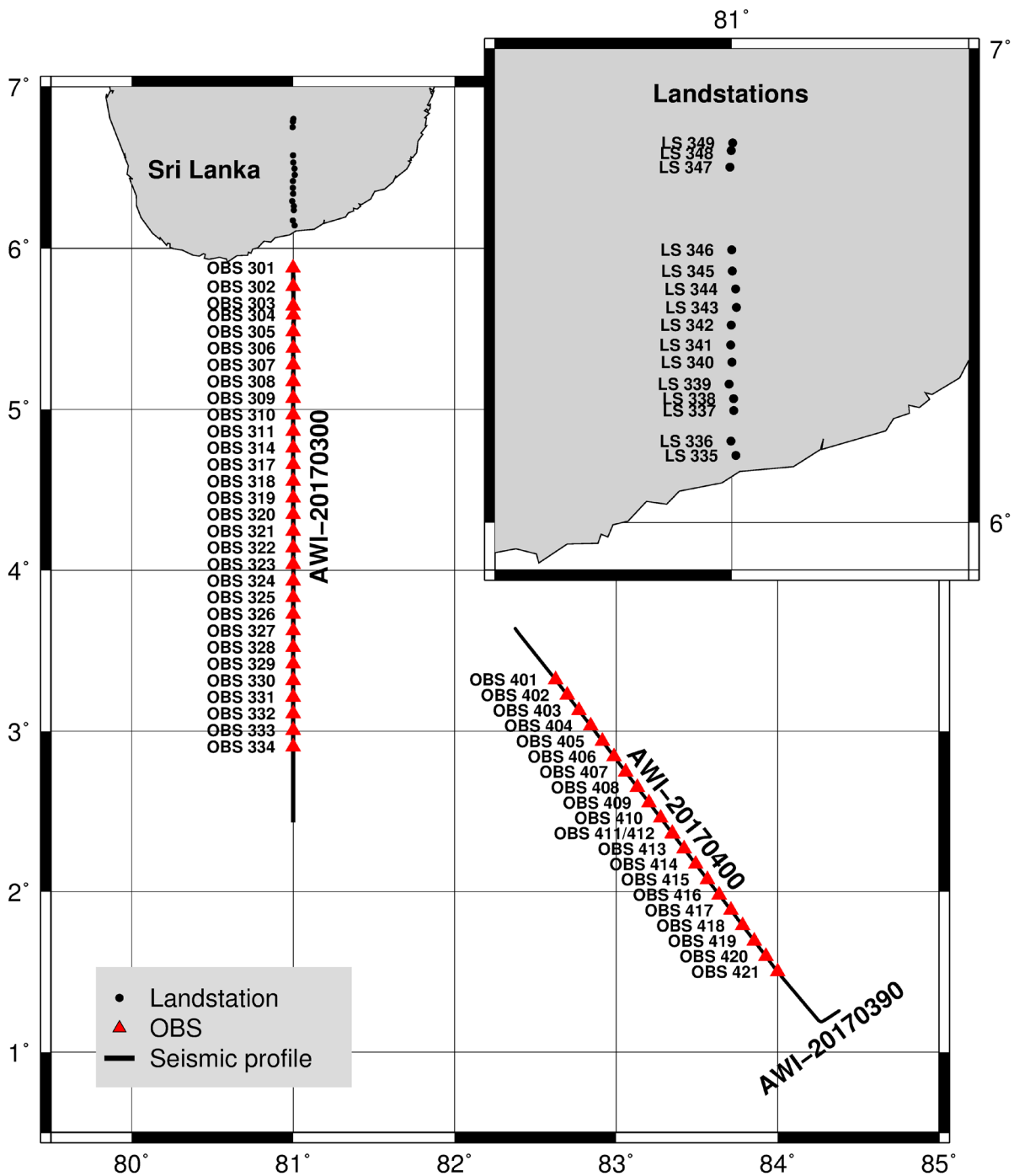
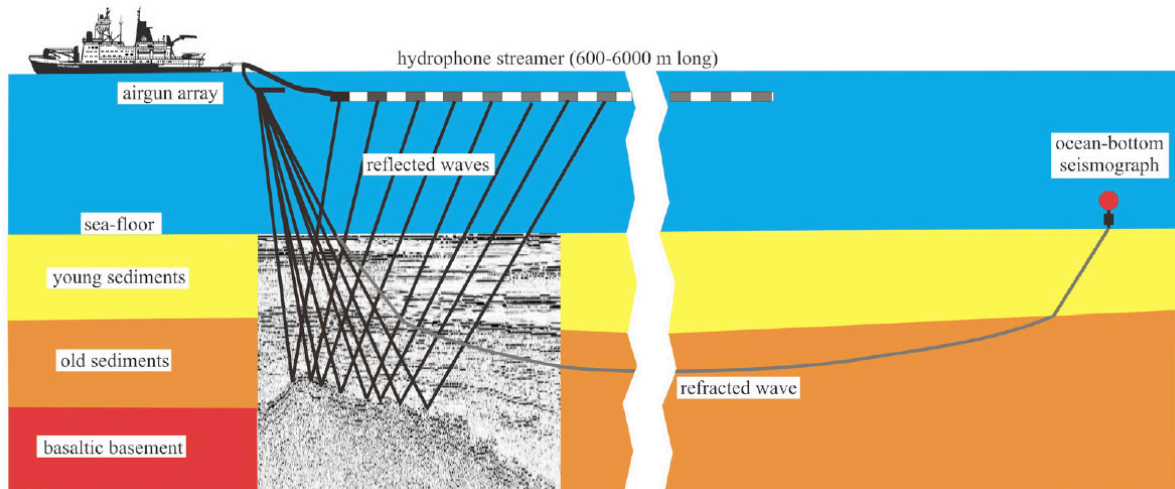

Fig. 5.2.1: Location of seismic reflection and refraction profiles, OBS stations and land stations.



*Fig. 5.2.2: Basic principles of refraction- and reflection seismic data acquisition.*



*Fig. 5.2.3: G-Gun array used as seismic source. Photograph by Marc Hiller.*

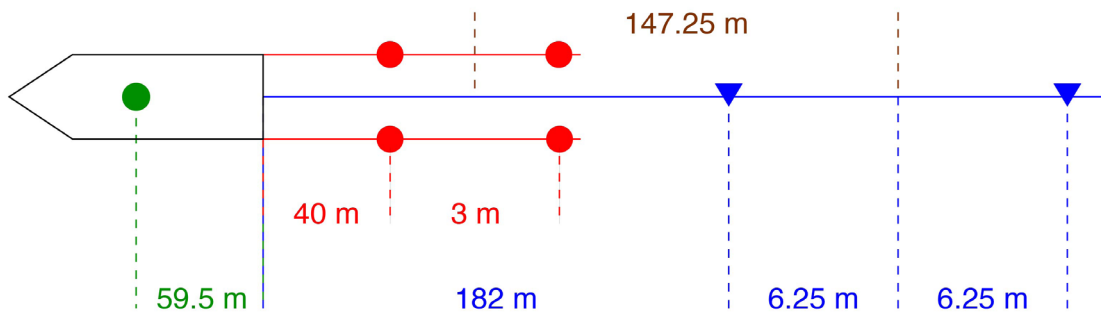

Distance GPS – stern: 59.5 m

Lead-in airguns: 40 m from stern, towing depth approx. 10 m

Distance between airguns: 3 m

Lead-in streamer: 182 m from stern, towing depth approx. 10 m

Group intervall: 12.5 m

Distance center source – center first group:  $182 \text{ m} + 6.25 \text{ m} - 40 \text{ m} - 1.5 \text{ m} = 147.25 \text{ m}$

**Fig. 5.2.4:** Setup of the seismic system during cruise SO258/2.  
Red: Pair of 2 airguns, green: GPS, blue: Streamer.

Shortly after leaving the harbour, all release units were tested in the water to ensure the proper functioning when deployed together with the OBS systems.

Prior to deployment, the OBS recorders were programmed and the internal clocks of the recorders were synchronized. The time synchronization was conducted with external GPS clocks. The sampling frequency was set to 250 Hz for all used recorders. Four channels were recorded with every AWI OBS and the Geomar OBS equipped with a Sercel recorder. With the Geolog recorders (Geomar OBS), the hydrophone channel was recorded twice and 5 channels were recorded in total. The recorded data were stored on internal hard-drives or flash cards of the recorders. The number of channels and corresponding geophone components, the gain settings and deployment positions are listed in Tables 5.2.1 and 5.2.2.

Deployment of the OBS was conducted without major problems. The first leveling of the TrilliumCompact seismometers was conducted 4 to 6 hours after deployment and then every hour if needed.

To recover the OBS, hydro-acoustic signals were sent from the vessel to the acoustic release unit. When receiving the signal, the hook connecting the anchor weight with the OBS frame is opened and the OBS returns to the sea surface. An automatic release time was also set as backup.

With one exception, all deployed OBS could be recovered. Unfortunately, OBS 407 along profile AWI-20170400 could not be released with the hydro-acoustic signal and did also not return to the surface after the programmed automatic release time. Therefore, no data for this OBS are available since the instrument is lost

**Tab. 5.2.1:** Deployment positions and settings of instruments deployed along seismic refraction profile AWI-20170300. Abbreviations: H=Hydrophone, X and Y: horizontal geophone components, Z=vertical geophone component, Error\*=no skew because of recorder failure.

Station	Instrument	Latitude (North)	Longitude (East)	Depth and Height (m)	Skew (us)	Recorder	Recorder No.	Channel Assignment								Gain		
								1	2	3	4	5	H	X	Y	Z		
301	OBS (AWI)	2°54.143'	81°0.000'	-4381	58719	6d6	61607078	H	X	Y	Z	-	4	1	1	1		
302	OBS (GEOMAR)	3°0.323'	81°0.000'	-4373	-600	GEOLOG	014	H	X	Y	Z	H	4, 16	16	16	16		
303	OBS (GEOMAR)	3°6.525'	81°0.014'	-4361	-900	GEOLOG	015	H	X	Y	Z	H	4, 16	16	16	16		
304	OBS (GEOMAR)	3°12.714'	81°0.004'	-4349	400	GEOLOG	018	H	X	Y	Z	H	4, 16	16	16	16		
305	OBS (AWI)	3°18.924'	81°0.010'	-4337	27090	6d6	61607073	H	X	Y	Z	-	4	1	1	1		
306	OBS (GEOMAR)	3°25.110'	81°0.008'	-4327	0	GEOLOG	004	H	X	Y	Z	H	4, 16	16	16	16		
307	OBS (GEOMAR)	3°31.311'	81°0.010'	-4321	-49000	Sercel	Geomar1	H	X	Y	Z	-	4	1	1	1		
308	OBS (AWI)	3°37.492'	81°0.011'	-4327	129293	6d6	61607080	H	X	Y	Z	-	4	1	1	1		
309	OBS (GEOMAR)	3°43.687'	81°0.007'	-4327	400	GEOLOG	007	H	X	Y	Z	H	4, 16	16	16	16		
310	OBS (GEOMAR)	3°49.904'	81°0.012'	-4334	1000	GEOLOG	005	H	X	Y	Z	H	4, 16	16	16	16		
311	OBS (AWI)	3°56.088'	81°0.007'	-4332	43956	6d6	61607079	H	X	Y	Z	-	4	1	1	1		
314	OBS (GEOMAR)	4°2.276'	81°0.034'	-4329	-200	GEOLOG	012	H	X	Y	Z	H	4, 16	16	16	16		
317	OBS (AWI)	4°8.483'	81°0.030'	-4325	20956	6d6	61607075	H	X	Y	Z	-	4	1	1	1		
318	OBS (GEOMAR)	4°14.672'	81°0.005'	-4320	204000	Sercel	Geomar-1	H	X	Y	Z	-	4	16	16	16		
319	OBS (GEOMAR)	4°20.872'	81°0.022'	-4314	-400	GEOLOG	021	H	X	Y	Z	H	4, 16	16	16	16		
320	OBS (AWI)	4°27.060'	81°0.016'	-4313	92851	6d6	61607076	H	X	Y	Z	-	4	1	1	1		
321	OBS (GEOMAR)	4°33.257'	81°0.019'	-4309	900	GEOLOG	019	H	X	Y	Z	H	4, 16	16	16	16		
322	OBS (GEOMAR)	4°39.452'	81°0.015'	-4300	-79000	Sercel	200-067	H	X	Y	Z	-	4	16	16	16		
323	OBS (AWI)	4°45.722'	81°0.012'	-4307	8599	6d6	61607071	H	X	Y	Z	-	4	1	1	1		
324	OBS (GEOMAR)	4°51.844'	81°0.011'	-4298	400	GEOLOG	010	H	X	Y	Z	H	4, 16	16	16	16		
325	OBS (GEOMAR)	4°58.068'	81°0.796'	-4291	2000	GEOLOG	002	H	X	Y	Z	H	4, 16	16	16	16		
326	OBS (AWI)	5°4.242'	81°0.007'	-4289	157979	6d6	61607084	H	X	Y	Z	-	4	1	1	1		
327	OBS (GEOMAR)	5°10.422'	81°0.010'	-4270	100	GEOLOG	016	H	X	Y	Z	H	4, 16	16	16	16		
328	OBS (GEOMAR)	5°16.632'	81°0.011'	-4271	error*	Sercel	200-072	H	X	Y	Z	-	4	16	16	16		

329	OBS (AWI)	5°22.826'	81°0.061'	-3898	133925	6d6	61607070	H	X	Y	Z	-	4	1	1	1
330	OBS (GEOMAR)	5°28.968'	81°0.020'	-3728	-3400	GEOLOG	011	H	X	Y	Z	H	4, 16	16	16	16
331	OBS (GEOMAR)	5°35.192'	81°0.068'	-3106	100	GEOLOG	017	H	X	Y	Z	H	4, 16	16	16	16
332	OBS (AWI)	5°38.552'	81°0.013'	-1821	56834	6d6	61607077	H	X	Y	Z	-	4	1	1	1
333	OBS (GEOMAR)	5°45.701'	81°0.008'	-1534	-200	GEOLOG	013	H	X	Y	Z	H	4, 16	16	16	16
334	OBS (GEOMAR)	5°52.713'	80°59.984'	-578.5	700	GEOLOG	009	H	X	Y	Z	H	4, 16	16	16	16
335	land station	6°8.503'	81°0.517'	5	-	DATA CUBE	810	Z	-	-	-	-	-	-	-	8
336	land station	6°10.313'	80°59.892'	4	-	DATA CUBE	812	Z	-	-	-	-	-	-	-	8
337	land station	6°14.203'	81°0.250'	36	-	DATA CUBE	813	Z	-	-	-	-	-	-	-	8
338	land station	6°15.710'	81°0.230'	45	-	DATA CUBE	815	Z	-	-	-	-	-	-	-	8
339	land station	6°17.550'	80°59.653'	59	-	DATA CUBE	816	Z	-	-	-	-	-	-	-	8
340	land station	6°20.323'	81°0.019'	87	-	DATA CUBE	817	Z	-	-	-	-	-	-	-	8
341	land station	6°22.499'	80°59.867'	81	-	DATA CUBE	818	Z	-	-	-	-	-	-	-	8
342	land station	6°25.027'	80°59.930'	108	-	DATA CUBE	819	Z	-	-	-	-	-	-	-	8
343	land station	6°27.275'	81°0.593'	106	-	DATA CUBE	857	Z	-	-	-	-	-	-	-	8
344	land station	6°29.611'	81°0.488'	125	-	DATA CUBE	827	Z	-	-	-	-	-	-	-	8
345	land station	6°31.876'	81°0.060'	137	-	DATA CUBE	826	Z	-	-	-	-	-	-	-	8
346	land station	6°34.556'	80°59.982'	161	-	DATA CUBE	824	Z	-	-	-	-	-	-	-	8
347	land station	6°45.035'	80°59.771'	705	-	DATA CUBE	823	Z	-	-	-	-	-	-	-	8
348	land station	6°47.123'	80°59.927'	1528	-	DATA CUBE	822	Z	-	-	-	-	-	-	-	8
349	land station	6°48.097'	81°0.113'	1567	-	DATA CUBE	821	Z	-	-	-	-	-	-	-	8

**Tab. 5.2.2:** Deployment positions and settings of instruments deployed along seismic refraction profile AWI-20170400. Abbreviations: H=Hydrophone, X and Y: horizontal geophone components, Z=vertical geophone component, Error\*=no skew because of recorder failure, lost = OBS could not be recovered.

Station	Instrument	Latitude (North)	Longitude (East)	Depth and Height (m)	Skew (us)	Recorder	Recorder No.	Channel Assignment								Gain		
								1	2	3	4	5	H	X	Y	Z		
401	OBS (AWI)	3°19.214'	82°37.508'	-4264	22689	6d6	61607073	H	X	Y	Z				4	1	1	1
402	OBS (GEOMAR)	3°13.490'	82°41.838'	-4266	300	GEOLOG	007	H	X	Y	Z	H			4, 16	16	16	16
403	OBS (AWI)	3°7.717'	82°46.208'	-4263	44680	6d6	61607078	H	X	Y	Z				4	1	1	1
404	OBS (GEOMAR)	3°1.989'	82°50.557'	-4275	-300	GEOLOG	021	H	X	Y	Z	H			4, 16	16	16	16
405	OBS (AWI)	2°56.248'	82°54.901'	-4286	54251	6d6	61607072	H	X	Y	Z				4	1	1	1
406	OBS (GEOMAR)	2°50.493'	82°59.202'	-4291	500	GEOLOG	019	H	X	Y	Z	H			4, 16	16	16	16
407	OBS (AWI)	2°44.744'	83°3.536'	-4299	Lost*	6d6	61607075	H	X	Y	Z				4	1	1	1
408	OBS (GEOMAR)	2°39.017'	83°7.841'	-4310	-600	GEOLOG	014	H	X	Y	Z	H			4, 16	16	16	16
409	OBS (AWI)	2°33.166'	83°12.245'	-4314	111659	6d6	61607080	H	X	Y	Z				4	1	1	1
410	OBS (GEOMAR)	2°27.528'	83°16.562'	-4318	400	GEOLOG	018	H	X	Y	Z	H			4, 16	16	16	16
411	OBS (AWI)	2°21.805'	83°20.892'	-4327	18405	6d6	61607079	H	X	Y	Z				4	1	1	1
412	OBS (AWI)	2°21.634'	83°21.016'	-4334	120715	6d6	61607083	H	X	Y	Z				4	1	1	1
413	OBS (GEOMAR)	2°16.034'	83°25.240'	-4347	-100	GEOLOG	004	H	X	Y	Z	H			4, 16	16	16	16
414	OBS (AWI)	2°10.292'	83°29.580'	-4360	87498	6d6	61607076	H	X	Y	Z				4	1	1	1
415	OBS (GEOMAR)	2°4.553'	83°33.917'	-4371	-100	GEOLOG	?	H	X	Y	Z	H			4, 16	16	16	16
416	OBS (AWI)	1°58.830'	83°38.288'	-4390	128747	6d6	61607070	H	X	Y	Z				4	1	1	1
417	OBS (GEOMAR)	1°53.086'	83°42.659'	-4401	100	GEOLOG	017	H	X	Y	Z	H			4, 16	16	16	16
418	OBS (AWI)	1°47.350'	83°47.005'	-4412	9858	6d6	61607071	H	X	Y	Z				4	1	1	1
419	OBS (GEOMAR)	1°41.591'	83°51.334'	-4415	400	GEOLOG	010	H	X	Y	Z	H			4, 16	16	16	16
420	OBS (AWI)	1°35.855'	83°55.663'	-4427	74610	6d6	61607077	H	X	Y	Z				4	1	1	1
421	OBS (GEOMAR)	1°30.010'	84°0.022'	-4426	Error*	GEOLOG	012	H	X	Y	Z	H			4, 16	16	16	16

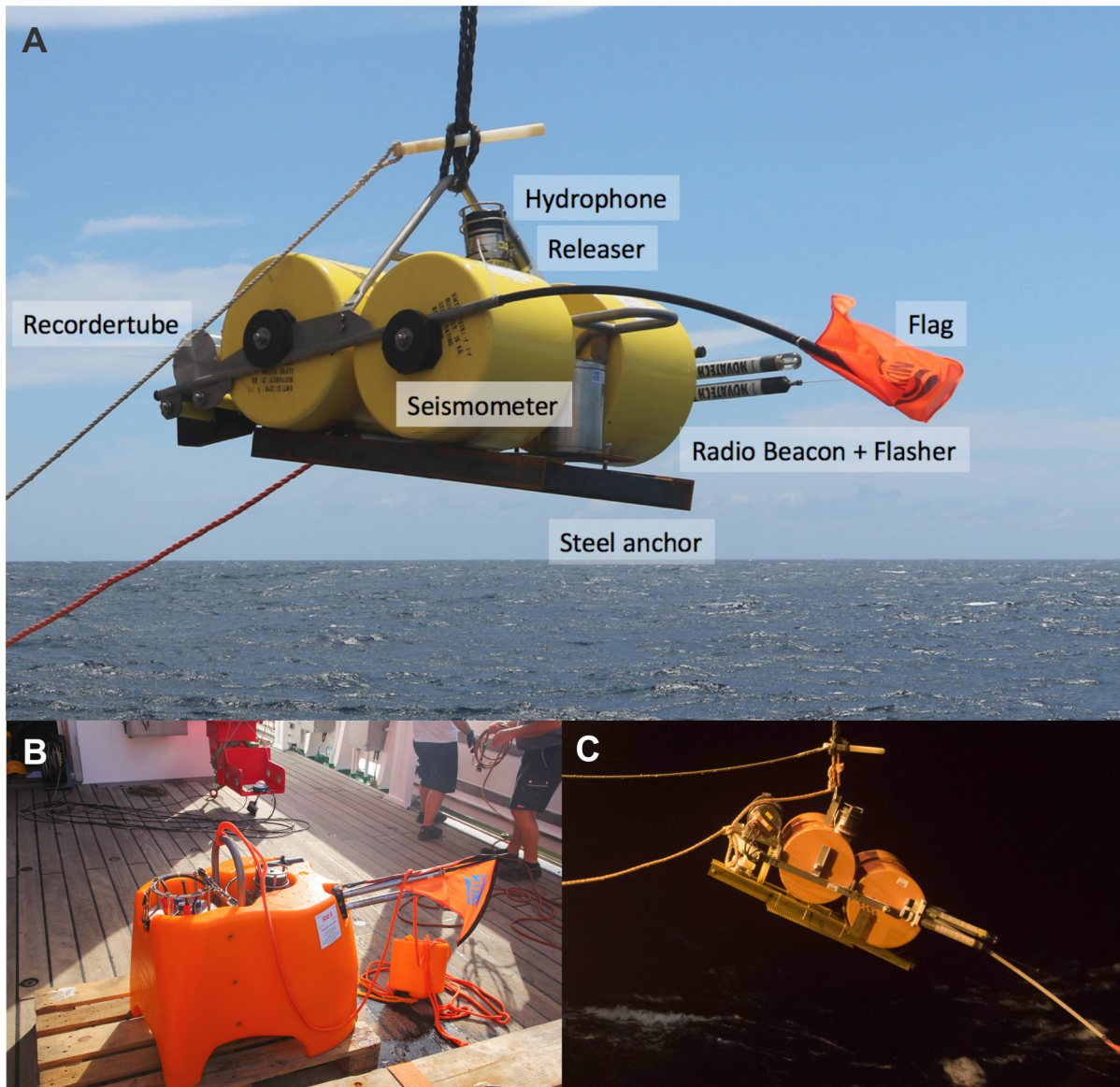

**Fig. 5.2.5:** Different OBS systems used for data acquisition during SO258-2. A: LOBSTER OBS with labeled equipment. B: NAMMU OBS after recovery. C: Geomar OBS during deployment.

*Pictures A & B were taken by Marc Hiller, picture C was taken by Konrad Behnke.*

All other OBS were recovered successfully and acquired data. Most OBS worked without major problems. After recovery, the OBS were cleaned with freshwater and dismantled. Data recording was stopped and the internal clock of every recorder was synchronized again with the GPS signal. The linear drift (skew) of every internal clock was determined. The raw data and recorder parameter files were downloaded to an external computer in different data formats, depending on the used OBS system.

Depending on the used recorders, the raw data was stored in 6d6-format and s2x-format (AWI OBS) or pseggy-format (Geomar OBS). Further processing was conducted with the software zp (by B. Zelt, <http://www.soest.hawaii.edu/users/bzelt/zp/zp.html>) and SU (Seismic Unix). In a first processing step, the recorded raw data were cut into 60s traces, the drift (skew) was corrected and the data was converted to SEG-Y-format. For the raw data of the AWI OBS, this

was already done onboard. Because of software problems, the data received from the Geomar OBS was converted to SEGY format after the cruise.

After the conversion to SEGY format, the offsets for every trace were calculated based on the deployment position of the OBS and shot positions. Because of currents, the OBS usually drift away from their deployment position when sinking to the seafloor. Therefore, the OBS positions were relocated along the profiles based on the direct wave: The trace with the shortest arrival time of the direct wave was determined and shifted to zero offset. Afterwards, the determined value was added to or subtracted from the previously determined offsets. The new calculated offsets were then written to the SEGY headers. A first quality control was conducted with the software zp.

### 5.2.3 Onshore data acquisition and processing

15 land stations were deployed at the landward prolongation of AWI-20170300 in southern and central Sri Lanka. The GFZ Potsdam and the GSMB Sri Lanka deployed the stations prior to the cruise. Like the OBS, the land stations registered the refracted and reflected signals of the seismic source. The acquired data give insights into the structure of the continental crust beneath Sri Lanka and the type and extent of the transition between the continental and oceanic crust.



**Fig. 5.2.6:** Partly buried land station in southern Sri Lanka. Photograph by Marc Hiller.

At each land station location, a Data Cube Recorder (Omnirecs), a battery pack and 2 geophone strings (each with six 4.5 Hz-vertical geophones, type SM-6, manufactured by Sensor Nederland) were installed. The recorder, the battery box and connectors were situated inside a plastic bag. The geophones were buried and deployed in a square or L-shape set



up with a footprint of 5x5 m. All the equipment was fully buried or covered by sand, wood and/or loose material. The sample rate was set to 100 samples/sec and the time interval for synchronizing the GPS signal was set to 15 min. Channel 1 (Z-component) recorded the data continuously with an amplifier gain of 8. The instrument settings and deployment positions are listed in Table 5.2.1.

After the cruise, all land stations were successfully recovered. For dismantling, all connectors were disconnected and the data was downloaded to an external Laptop via an USB-cable.

### 5.2.4 Multi-channel seismic recording system

A digital SERCEL SEAL™ 408 streamer with an active length of 3,000 m (12 sections) was used to acquire seismic reflection data. The streamer is a 240-channel hydrophone array, which is coupled to the onboard recorder via a fibre-optic tow lead and a deck lead. The group interval of the active sections is 12.5 m. The data collected by the hydrophone array is firstly converted from an analogue signal to digital via an A/D converter and then converted to a 24-bit complement format at 0.25 ms sample rate by a DSP. The data is routed to a Line Acquisition Unit Marine (LAUM) at this point, one of these being located every five Acquisition Line Sections or 750 m. The LAUM decimates, filters and compresses the data before routing them through the tow leader and deck lead to the on-board equipment.

The lead-in together with the inactive sections, measured from stern, was 182 m (distance to first channel). The streamer was towed in approximately 10 m depth. Cable depth keeping was monitored on Digicourse™ software, and adjustment to depths was made with Digibirds™, Model 5010. The Digicourse software gives a continuously updated graphical display of depths and wing angles via the Digibirds™, which are situated at 300 m intervals along the streamer. All deployment and recovery actions went smooth and without problems.

The coupling of the streamer with the Control Module (CMXL) is made via the Deck Cable Crossing Unit (DCXU), which also acts as a LAUM for the first 60 channels of the streamer. The CMXL decompresses, demultiplexes and then performs IEEE 32-bit conversion to the data. The data are collected via a network switch and converted to SEG-D by the PRM, the PRM being a processor software module used for formatting data to and from the cartridge drives, the plotters and Seapro QC™. All system parameters can be set through the Human Computer Interface (HCI) which displays the systems activity such as print parameters, log files, high resolution graphic display and test results. The combined HCI/PRM system had a failure at the beginning of the cruise, most probably due to a damage to an internal hard drive. Therefore, the seismic reflection system was not in operation during acquisition of profile AWI-20170300.

Seismic reflection data were recorded with acquisition software provided by Sercel internally and on tape. Sample rate was set to one sample per 2 ms. Data were recorded as multiplexed SEG-D. Recording length was 18 seconds. One file was generated per shot. Online quality control was performed displaying shot gathers and as single channel profile.

### 5.2.5 Preliminary results

#### *Profile AWI-20170300*

30 OBS and 15 land stations were deployed along AWI-20170300. The length of the profile is ~375 km. Start- and endpoint of the profile is listed in Table 5.2.3. The average distance between the deployment position of the marine stations is 11.5 km. Along the shelf, the stations were deployed in greater and smaller distance in order to avoid locations within ship traffic routes. The planned stations 312-313 and 315-316 were not deployed due to hardware problems. The distance between the land stations varies between 3 to 7 km, with the exception

of a gap of ~20 km between land station 346 and 347, where deployment was not possible due to inaccessibility of the region.

The data quality of the recorded OBS data varies from sparse to very good. In general, the vertical geophone component (Z channel) has the best signal-to-noise ratio. An example is shown in Fig. 5.2.7. Any modeling of the seismic refraction data will be performed after the cruise. Therefore, we will not show any preliminary results.

#### *Profile AWI-20170400*

21 OBS were deployed along AWI-20170400. The length of the profile is ~340 km. Start- and endpoint of the profile is listed in Table 5.2.3. OBS 412 and 411 were deployed in a distance of only ~230m. The reason for that was to compare data from the new NAMMU OBS-system (station 412) with data from the older LOBSTER-system (station 411). The average distance between the deployment location of the other OBS is ~13.5 km. Unfortunately, OBS 407 could not be recovered.

The data quality of the seismograms of the profile ranges from good to excellent. An example is shown in Fig. 5.2.8. P-wave phases can partly be observed within an offset range of up to 150 km. In most cases, the vertical geophone component (Z channel) has the best signal-to-noise ratio even for S-wave phases. Modeling of the acquired data will be performed after the cruise.

The seismic reflection data along the profile is of high quality and clearly images sedimentary structures, oceanic basement, and intra-basement reflections (Fig. 5.2.9).

**Tab. 5.2.3:** Start and end points of seismic profiles.

	Latitude (N)	Longitude (E)	Latitude (E)	Longitude (N)
AWI-20170300	80°59.965'	5°48.840'	80°59.999'	2°25.916'
AWI-20170390	84°22.836'	1°15.459'	84°14.519'	1°12.689'
AWI-20170400	84°14.473'	1°12.749'	82°22.515'	3°38.288'

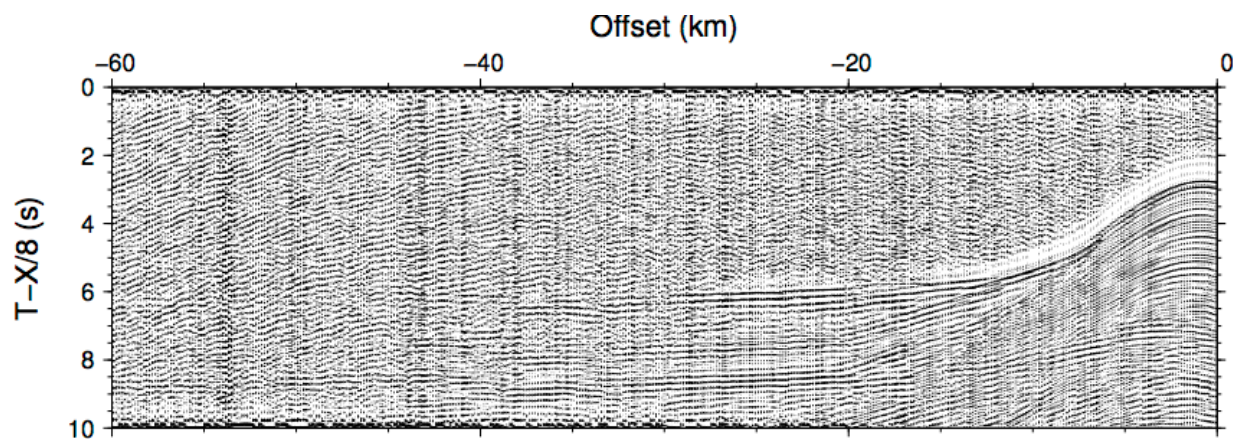

**Fig. 5.2.7:** Parts of a seismogram (Z-component) of an OBS deployed in the deep-sea area along profile AWI-20170300

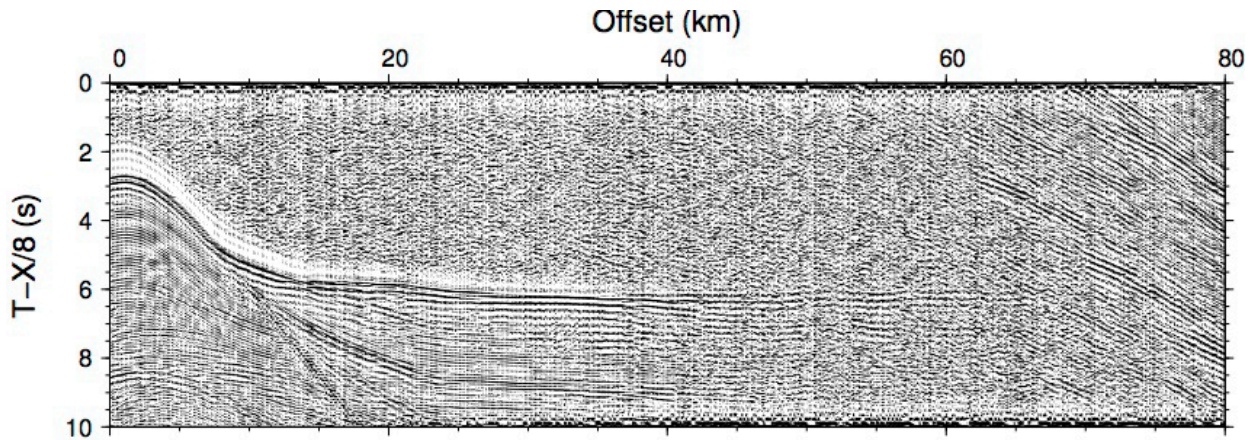

Fig. 5.2.8: Parts of a seismogram (Z-component) of an OBS deployed in the deep-sea area along profile AWI-20170400

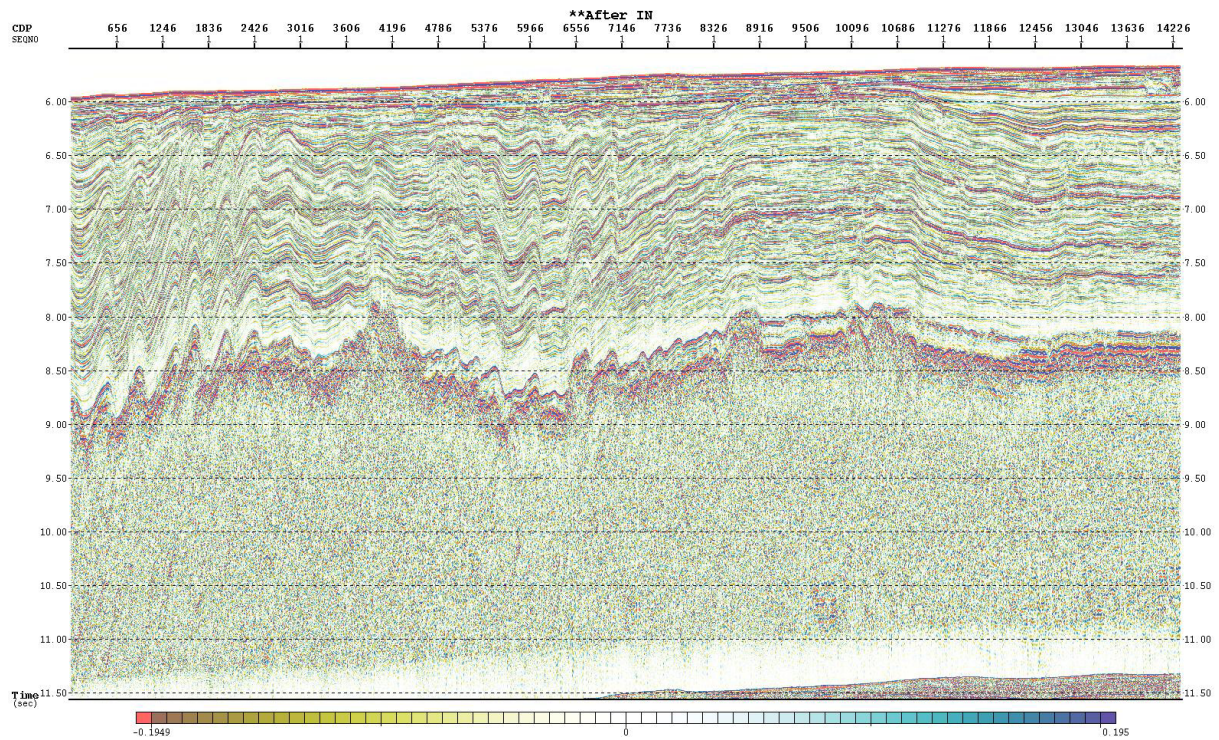

Fig. 5.2.9: Brute stack of seismic reflection profile AWI-20170400.

## 5.3 Hydro-acoustics

Ralf Krockner<sup>1</sup>, Oleg Levchenko<sup>2</sup>, Wolfram Geissler<sup>1</sup>,  
Mareen Lösing<sup>1</sup>, Dulap Ratnayake<sup>3</sup>, Isuri Kapuge<sup>4</sup>, Nadee  
Nanayakkara<sup>4</sup>

<sup>1</sup>AWI  
<sup>2</sup>IO RAS  
<sup>3</sup>NARA  
<sup>4</sup>UR

### 5.3.1 Technical descriptions

Multibeam bathymetry data were acquired for combined analysis with magnetic and gravity data. Deep-sea multibeam echosounder installed on *Sonne* is a Kongsberg EM122 (<http://hdl.handle.net/10013/epic.51613>) with a transducer size of 16 m (Tx) by 8 m (Rx) and 0.5° by 1.0°,

respectively. During cruise SO258/2, the system was operated in dual ping mode, equidistant mode, and applying chirp mode. The number of beams per ping amounts to 432 covering a swath angle up to 150 degrees. During this cruise, a swath angle of 140 degrees was chosen to achieve an almost not frayed outer rim.

The PARASOUND System DS3 (P70) is a hull-mounted parametric echo sounder developed by ATLAS HYDROGRAPHIC GmbH, Bremen, Germany. The transducer transmits signals with 70 kW transmission power to enable a maximum penetration depth of about 200 m in soft sediments. The system uses the parametric effect that occurs when very high (finite) amplitude sound waves are generated. If two waves of similar frequencies are generated simultaneously, the sum and the difference of the two primary frequencies are also emitted. For the PARASOUND System, 18 kHz is one fixed primary frequency that distributes energy within a beam of 4.5° for a transducer of approximately 1 m length. The second primary frequency can be varied between 18.5 and 24 kHz, resulting in difference frequencies from 0.5 to 6.0 kHz. This signal travels within the narrow 18 kHz beam, which is much narrower than e.g. the 30° beam of a 4-kHz signal when emitted directly from the same transducer. Therefore, a higher lateral resolution can be achieved, and imaging of small-scale structures on the sea floor is superior to conventional systems. The system treats three signals separately: the primary high frequency signal (18 kHz; PHF), the secondary low frequency signal (selectable 0.5 to 6.0 kHz; SLF) and the secondary high frequency (selectable 36.5 to 42 kHz; SHF). During the cruise we choose a SLF of 4.0 kHz.

### 5.3.2 Work at sea

Data acquisition started at 13:40 UTC on July 12<sup>th</sup> 2017. The system was operated during the entire cruise except during OBS recovery. Data acquisition stopped at 17:30 UTC (23:00 LT) on August 16<sup>th</sup> 2017, i.e. in the night before arrival in Colombo. Operating application SIS (Kongsberg - Seafloor Information System) was operated during the whole cruise with only one failure and restart on August 15<sup>th</sup>.

Eight parallel profiles were measured in NS direction starting on Sri Lanka Shelf at ca. 6°00'N until 3°30'S (see Fig. 4.1.1). The westernmost profile runs along longitude of 80°50'40"E. Parallel profiles were acquired every 17.2 km (9.2 nm). The two westernmost profiles reach 11°17'S and have lengths of 1,880 km (1,015 nm). Profiles 3 to 8 have lengths of at least 1,030 km (556 nm). Along the second OBS profile, a bathymetry profile with length of ca. 400 km (216 nm) and a parallel profile with a length of 340 km (184 nm) were acquired. Neglecting repeatedly sailed tracks during OBS operation as well as transits, a complete bathymetric profile length of 5,777 nautical miles (10,700 kilometers) was sampled. The covered area amounts to 180,000 square kilometers. Storage of water column data was performed parallel to the storage of targets.

During the cruise, manual data editing with Caris HIPS/SIPS Swath Editor was executed. Raw data consist of 312,685 pings with 129,847,474 beams. During manual editing, 2,037,697 beams (ca. 1.5 percent) were marked to be outliers. Especially in Nadir direction many beams were situated implausible high or deep.

Export xyz ASCII files as well as backscatter data were provided to the scientific parties on board. Data were gridded by profile for combined interpretation with gravity and magnetic data. Furthermore, grids covering the complete survey area were calculated. For all grids, a spacing of 50 meters was chosen. Data cover INT region J charts by means of IHO publication S-11: INT 706, INT 707, INT 753, INT 754 and INT 7386.

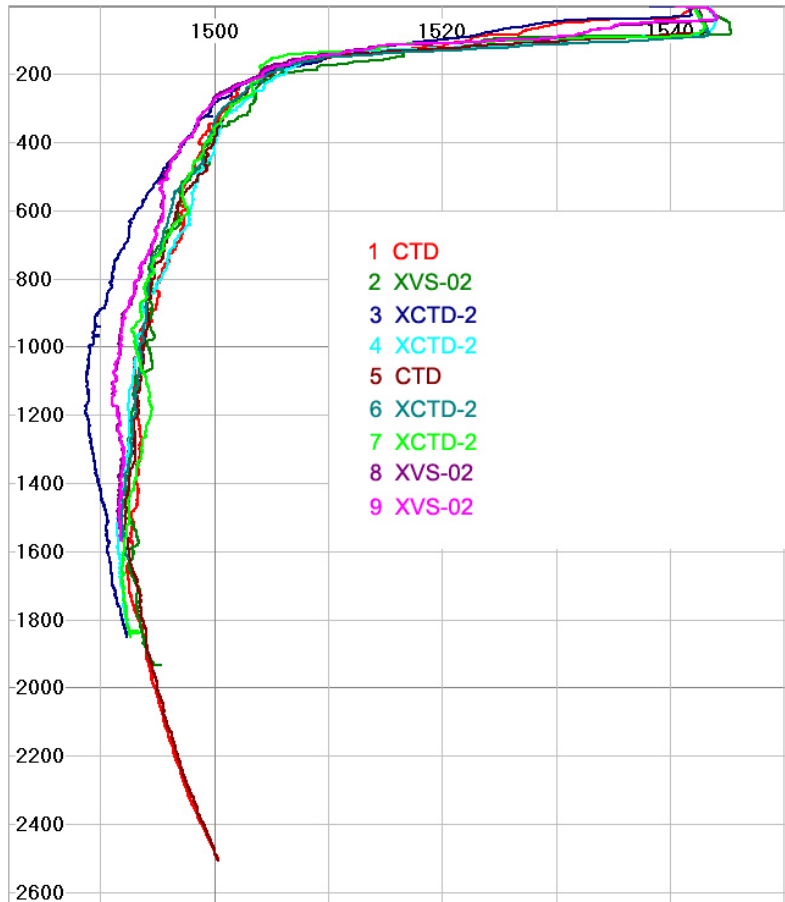

**Fig. 5.3.1:** Edited sound velocities of downcast of CTD, XCTD-2 and XVS-02 probes.

For bathymetry measurements, an appropriate sound velocity profile needs to be applied (Fig. 5.3.1). Due to lack of time, only two CTD casts were performed. These CTD casts were deployed at a depth of 2,500 m. Values at larger depths are extrapolated applying Kongsberg SVP Editor. All other casts were executed deploying expendable probes with no need to stop the ship. Expendable velocity probes of type XVP-02 and expendable CTD of type XCTD2 were used, both manufactured by Lockheed Martin Sippicon. Table 5.3.1 lists all casts:

**Tab. 5.3.1:** List of CTD, XCTD2 and XVP02 casts.

No.	Type	Date	Time	Position	Seafloor depth	Probe depth
1	CTD	12.07.2017	11:56	05° 34.883' N, 080° 12.109' E	3828 m	2504 m
2	XVP-02	14.07.2017	09:14	00° 00.299' S, 080° 50.613' E	4623 m	1938 m
3	XCTD-2	16.07.2017	09:40	07° 59.662' S, 080° 50.669' E	5235 m	1850 m
4	XCTD-2	20.07.2017	22:48	03° 00.506' N, 081° 00.123' E	4370 m	1850 m
5	CTD	04.08.2017	09:20	03° 19.114' N, 082° 37.762' E	4264 m	2506 m
6	XCTD-2	04.08.2017	11:25	03° 19.110' N, 082° 37.640' E	4263 m	1623 m
7	XCTD-2	06.08.2017	05:27	01° 28.281' N, 083° 59.842' E	4432 m	1850 m
8	XVS-02	08.08.2017	20:48	03° 00.019' S, 081° 27.909' E	5065 m	1534 m
9	XVS-02	08.08.2017	20:59	03° 00.841' S, 081° 27.906' E	5066 m	1569 m

On August 4, a second XCTD was deployed after a previously deployed XCTD gave erroneous results. On 08<sup>th</sup> of August, two XVS02 probes were deployed because the first one stopped recording at 1,534 meters whereat a depth of 2,000 meters should be possible. Unfortunately, the second one stopped recording nearly at the same depth of 1,569 meter. An additional probe was not deployed. All probes needed to be manually edited in post-processing to remove outliers and false values.

Only the first CTD from July 12<sup>th</sup> was applied for multibeam measurements. Since the depth values of expendable casts are calculated by time, the reliability of depths is decreased. As the bathymetric swaths did not show obvious refraction artefacts, the application of improved sound velocity profiles may only be performed in post-processing.

The PARASOUND system was continuously running from July 12<sup>th</sup> 2017 till August 16<sup>th</sup> in single pulse mode. During OBS deployment and recovery, acquisition and storage was switched off. During operation, the system ran without major problems and only a few shut-downs caused by failures occurred. The SLF (4 kHz) and PHF (18 kHz) raw data were stored as ASD files. Additionally, the SLF signal was stored in PS3 and segy format after replay.

### 5.3.3 Preliminary results

The cruise SO258/2 was mostly aimed at determination of deep structure and age of oceanic crust south of Sri Lanka by combining results from a deep seismic sounding, magnetic and gravity surveys. The distance between north-south-profiles was chosen appropriate for magnetic and gravity meter measurements. The multibeam data were acquired to image detailed relief of sea floor and the SLF data (4 kHz) of the ATLAS PARASOUND echosounder were acquired to image structure of the uppermost part (up to 100 m bsf) of the sedimentary layer. In addition to the main objectives of the cruise, the hydro-acoustics let independently solve a number of unique scientific problems. The two most important and interesting objects are: (1) channel–levee systems of the Bengal Fan, the largest submarine fan in the World Ocean (sedimentologic and palaeoceanologic implications); and (2) surface expression of underlying deformed ocean crust and overlying sedimentary section in the Central Indian Ocean (tectonic implications). As swath angle of multibeam could be set to a large angle of 140 degrees a full coverage rectangle with size of 1,050 x 140 kilometer could be observed. In the northern part, the profiles cover very flat sea floor of the Bengal Fan. The seafloor is slightly sloping with depths of approximately 4,250 meters in the north, 4,600 meters in the middle and 5,200 meters in the south (Figs 5.3.2 and 5.3.3). In the northern part a lot of channels could be traced. The most dominant one has a width of one kilometer at the top and a depth of approximately 80 m as can be seen in fig. 5.3.2. The collected PARASOUND data display the active channels and reveal complicated layered strata of lenticular sedimentary bodies of levees and barred channels (Fig. 5.3.4). The large faulted and folded tectonic blocks, which were formed as unique compressional intraplate deformations in the result of continental collision of India and Asia, are clearly expressed on this smooth sea floor (Fig. 5.3.5). These young irregular features are superimposed on nearly E-W striking original spreading normal faults forming a very complicated tectonic structure, which is also reflected in the magnetic field. These ancient faults are distinctly prominent in multibeam data in the south where the Bengal Fan sedimentary wedge ceases (Fig. 5.3.3). Detailed interpretation of the acquired hydro-acoustic data will be performed after the cruise.

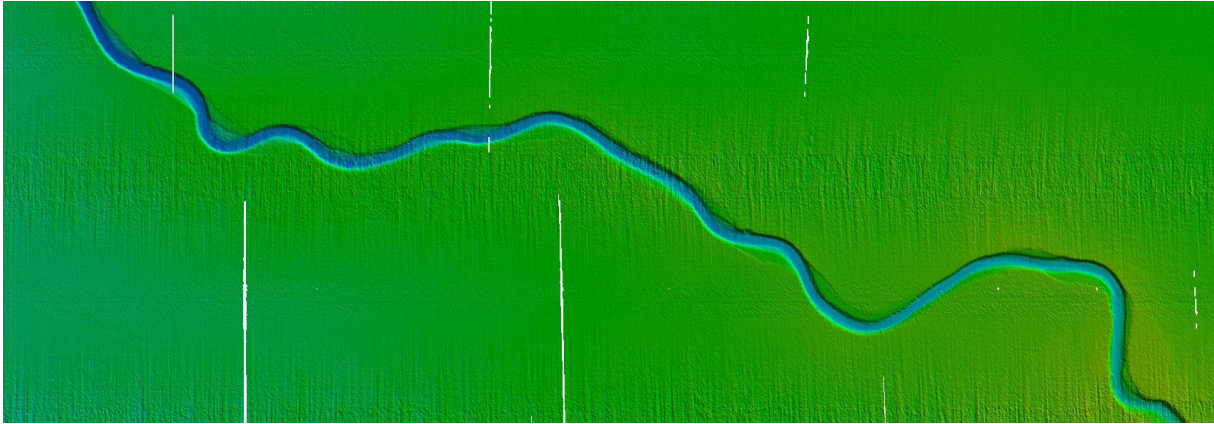

**Fig. 5.3.2:** Channel at the Bengal Fan in water depth of 4,400 m. The channel is up to 1 km wide and up to 80 m deep. (The north orientation is on the right of the image.)

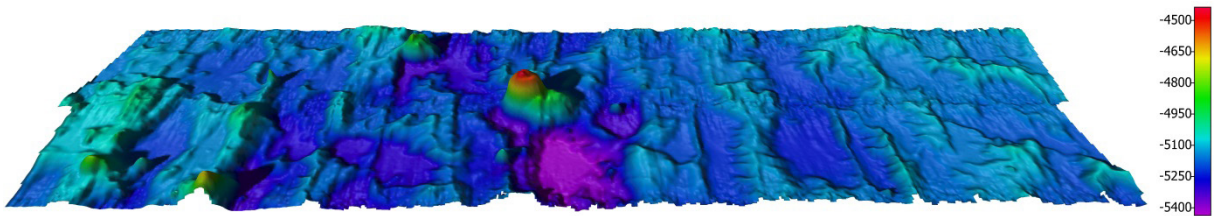

**Fig. 5.3.3:** 3D view of southern profiles generated applying QPS Qimera/Fledermaus.

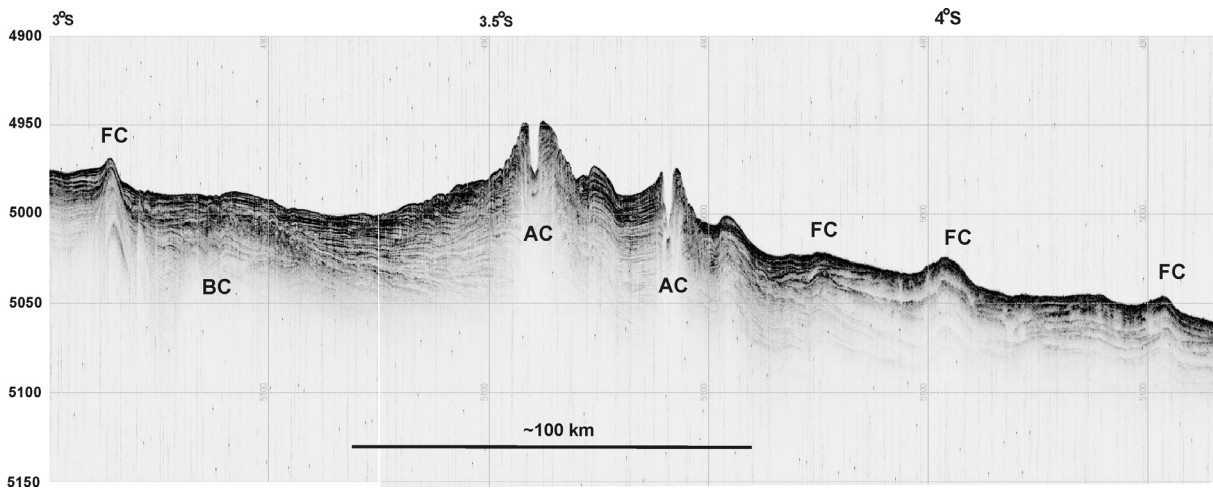

**Fig. 5.3.4:** N-S PARASOUND SLF profile along 80°50'E. AC - active channel of turbidity current; BC – buried inactive channel; FC – covered fault scarp.

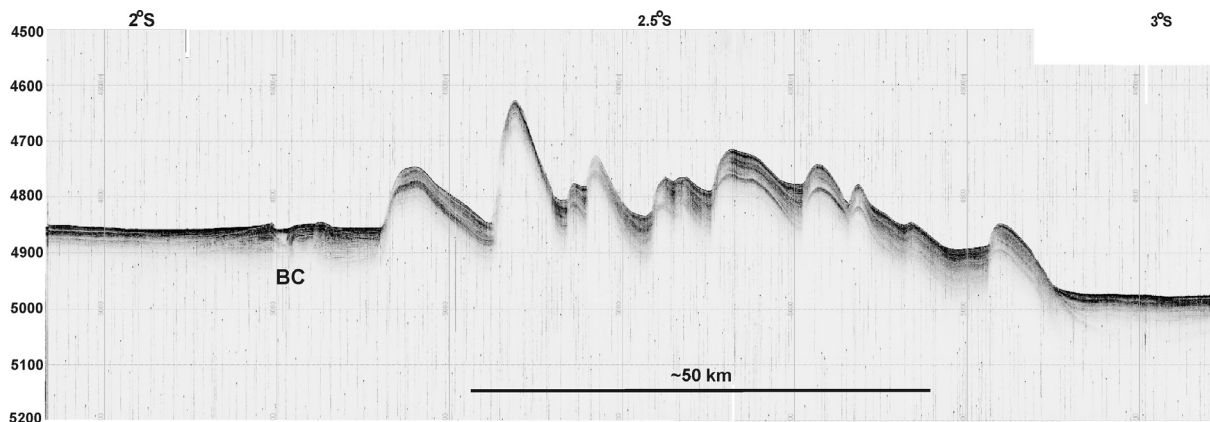

**Fig. 5.3.5:** N-S PARASOUND SLF profile along 80°50'E. Large deformed tectonic block. BC – buried inactive channel of turbidity current.

## 5.4 Gravity

Ralf Krockner<sup>1</sup>, Graeme Eagles<sup>1</sup> (not on board), Wolfram Geissler<sup>1</sup>, Konrad Behnke<sup>1</sup> <sup>1</sup>AWI

### 5.4.1 Work at sea

A Bodenseewerke KSS32-M gravity meter, normally installed on *Polarstern*, measured relative gravity throughout leg SO258/2 (Fig. 5.4.1). The system was installed on a destined table in gravity meter room on *Sonne* on Deck 2 on July 10<sup>th</sup>, 2017. The mounting plate is located 0.15 m below bolt B94 that is located 7.53 m above the keel of *Sonne*.

Positioning and motion data were provided from ship data management system. The gravity meter is free from cross coupling errors. As the tie point measurements have not been processed and incorporated to the gravity meter, no valid free air anomalies and Bouguer anomalies are registered. Eötvös correction was not switched on for real-time application. Filter interval was set to 174 seconds and filter order was set to 4. Both parameters are appropriate for calm to medium sea state. Data were logged almost continuously with only a few exceptions until the end of measurements on August 16<sup>th</sup>, 2017. Two sets of onshore tie measurements were made in Colombo at the very beginning and very end of the leg. These measurements allow us to convert the shipboard data to absolute gravity values and correct them for instrument drift. Figure 5.4.2 shows a data example.

### 5.4.2 Tie and drift measurements in Colombo

Before and after the cruise, tie point measurements applying Lacoste & Romberg gravity meter #744 have been executed. Measurements were carried out both manually and with a feedback unit. For reasons of consistency, only the feedback values will be used for the determination of absolute gravity. At each spot, the instrument was placed on a tripod-plate. The internal temperature of the instrument showed a constant value of ~50°C during the measurements. The sea gravity meter was continuously in operation, while the onshore tie measurements were conducted.

Taking into account that the sites belong to a cargo harbour with a high amount of activities, vibrational disturbance was low. By observation it is estimated to  $\pm 0.05$  mgal. Factory repetitivity is given within  $\pm 0.02$  mgal, which sums to an error of  $\pm 0.07$  mgal.



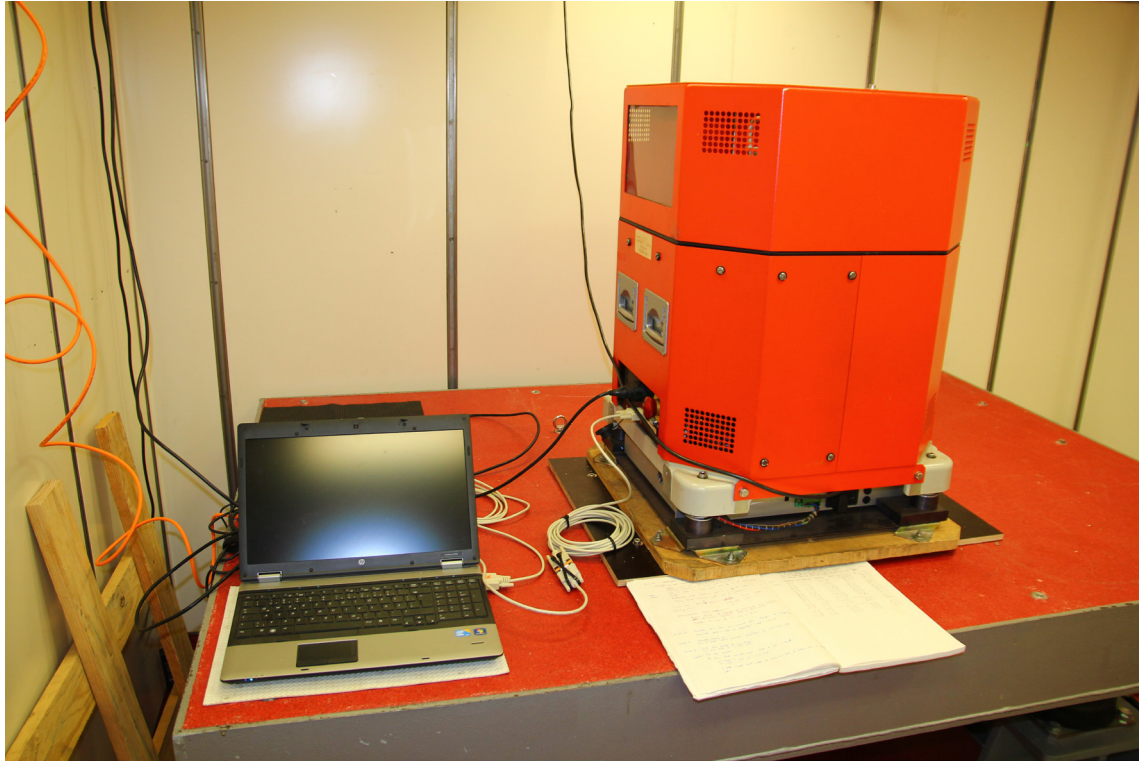

*Fig. 5.4.1: Bodenseewerke KSS-32 gravity meter on Sonne.*

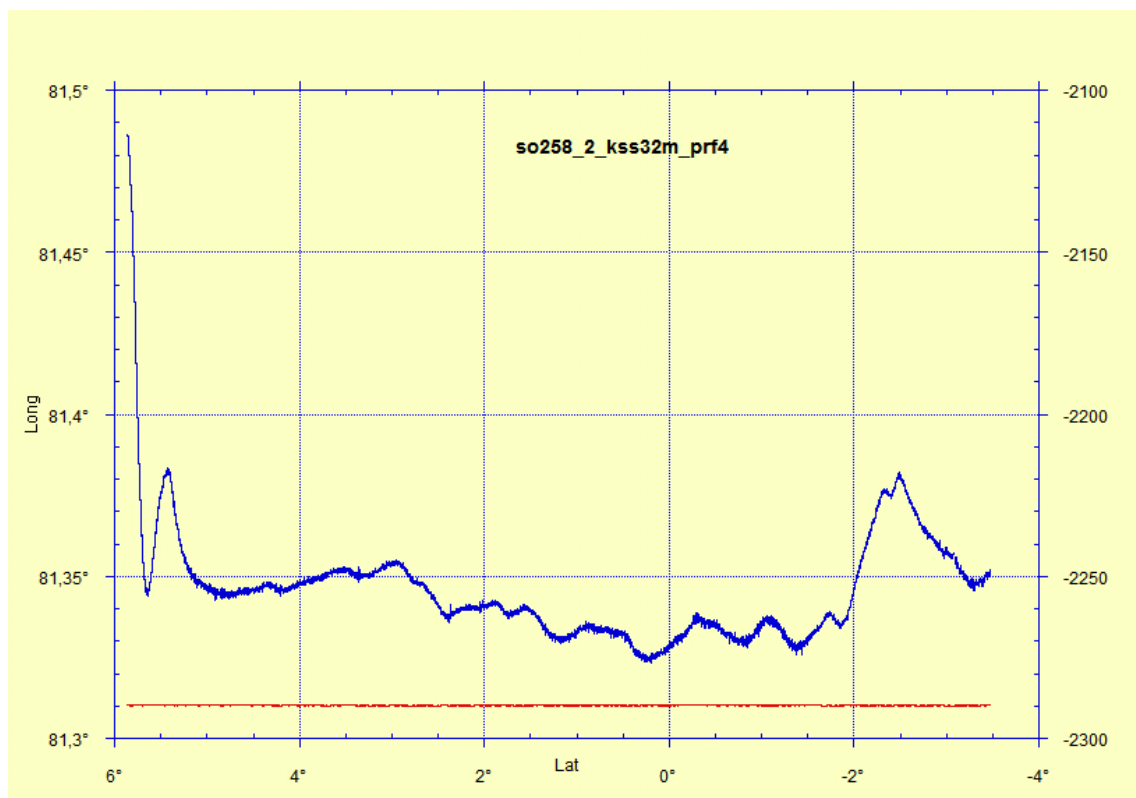

*Fig. 5.4.2: Data example from the sea gravity meter KSS32-M.  
Red line, longitude; blue line, relative gravity in mGal.*

The total relative gravity  $G_{\text{tot,rel}}$  for each measurement with the L&R land gravimeter was derived by the help of the instrument's specific interpolation table as follows: All measured values  $M$  lay in-between 1,500 and 1,600 counter units (CU), which means to have a scale fix value of 1,500 CU and thereby a calibration fix  $C$  of 1,523.46 mgal. The valid calibration factor  $f$  is 1.01494. Additionally, the feedback unit delivers the offset  $FO$  straight in mgal. So, we have:

$$G_{\text{tot,rel}} = C + f(M-1500) + FO = 1523.46 \text{ mgal} + 1.01494(M-1500) + FO$$

Prior to the cruise, the gravity meter was installed on a point at north pier nearby the ship and bollard #5. This is very close to the old tie point 000361 "Colombo Harbour". However, the pier had been modified in the past years. It does not look like anymore as on the sketch on BGI's webpage (see Figs 5.4.3 and 5.4.4.). The measurement was done three times, one in the evening July 11<sup>th</sup>, two in the morning July 12<sup>th</sup> shortly before cruise departure. Due to missing permissions, we were not able to visit tie points in the city for additional absolute link.

After the cruise, the permissions were granted so we visited two locations in the city of Colombo on August 17<sup>th</sup>. The visit was assisted by colleagues from Sri Lanka Geological Survey and Mines Bureau which were leading us to the locations. Unfortunately, the locations have been changed by means of destruction of buildings and surroundings. Furthermore, the last measurements to update the reference gravity values took place many years ago. There might be confusion between coordinates (6.95000N, 79.86667E, "Prince Street") and reference name ("French Consulate") for BGI reference gravity station #000360. On the second BGI reference gravity station #000363 a constructional change seems to have happened as well.

The final tie point measurement has been performed on the previous used point nearby the ship at bollard #5. All measurements have been applied using feedback mode of Lacoste & Romberg gravity meter. Exceptional of first record additional manual readings have been executed.

During the entire cruise the gravity meter KSS32-M was running without any interrupt due to failures. To avoid any conflicts the data acquisition was stopped on August 1<sup>st</sup> for data download to USB stick. The data recording was stopped at 17:30 UTC (23:00 LT) on August 16<sup>th</sup> 2017, the night before arrival in Colombo. The data recording was temporarily switched on again on 17<sup>th</sup> August during tie point measurements with Lacoste & Romberg gravity meter.

#### *Measurement #1 (Table 5.4.1, Figs 5.4.3, 5.4.4)*

Instrument:	LaCoste & Romberg gravimeter, G-744 with feedback
Temperature:	49.95°C
Location:	Colombo Harbour, new North Pier, between bollard 5 and 6
Coordinates:	06°57.506'N 79°51.343'E
Height above waterline:	2.10 m
Draft of vessel:	between 6.20 and 6.40 m
Date:	11. July 2017
Conditions:	calm until arrival of a car, darkness
Abs. gravity:	978121.860 mGal (close to old BGI tie point 000361, pier has been modified!)
Present:	Wolfram Geissler, Ralf Krockner

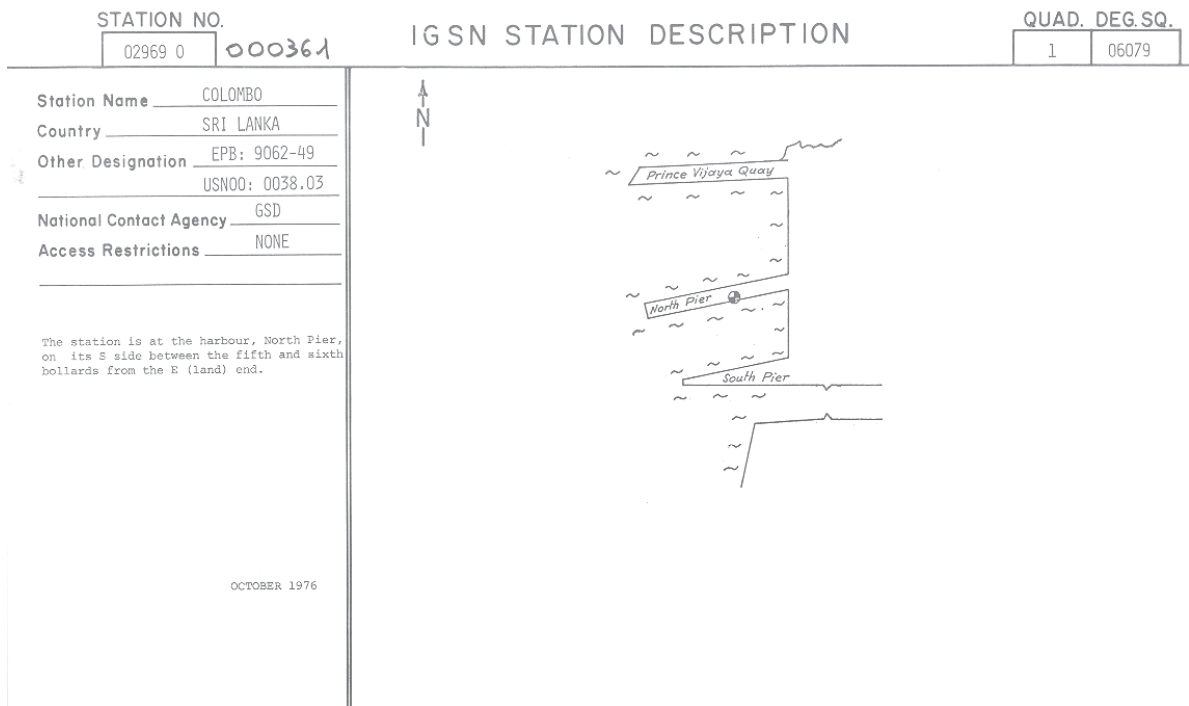

**Fig. 5.4.3:** Location of old tie point 000361 at the North Pier in Colombo.  
 Source: <http://bgi.omp.obs-mip.fr/data-products/Gravity-Databases/Reference-Gravity-Stations>.

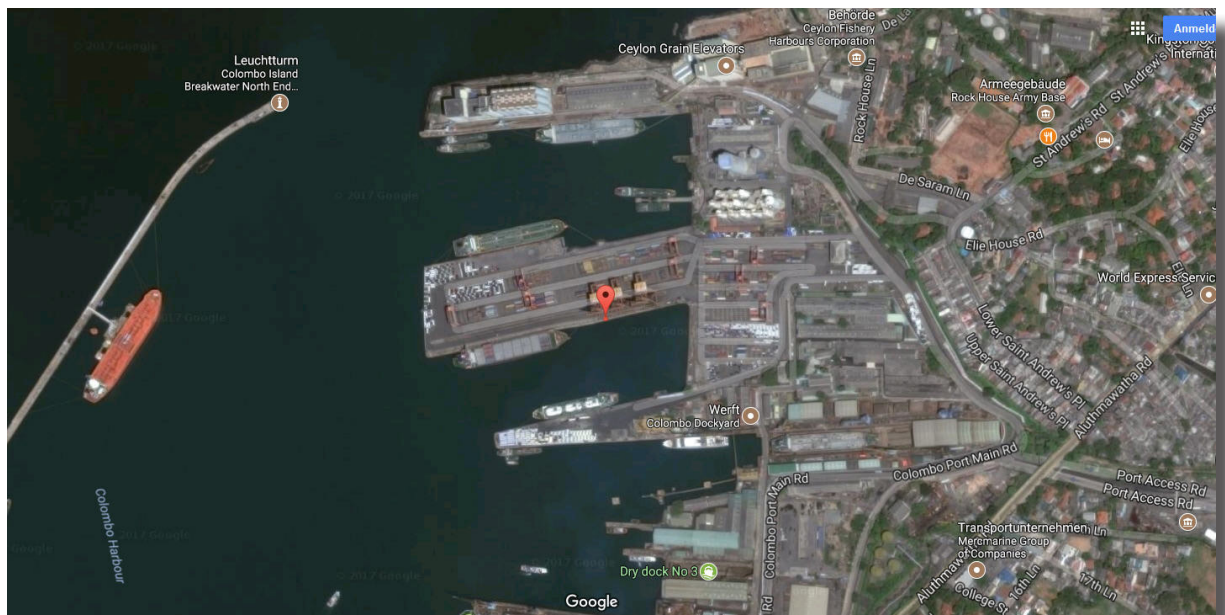

**Fig. 5.4.4:** Location of tie points #1-3 & #6 at the new North Pier in Colombo. Source: GoogleMaps.

**Tab. 5.4.1:** Gravity measurements #1 at North Pier in Colombo on 11. July 2017. Cursive marked measurements are not used to calculate the average reading value.

Time [LT]	Time [UTC]	Type	Counter reading [CU]	Feedback [mGal]	Counter reading [mGal]	Total gravity [mGal]	KSS32M gravity [mGal]
20:00	14:30	<i>feedback</i>	1566.00	25.173	1590.45	1615.62	-2120.09
20:04	14:32	<i>feedback</i>	1560.00	31.213	1584.36	1615.57	-2119.56
20:05	14:35	<i>feedback</i>	1555.00	36.276	1579.28	1615.56	-2120.24
20:06	14:36	<i>feedback</i>	1550.00	41.285	1574.21	1615.49	-2119.99
20:07	14:37	<i>feedback</i>	1545.00	46.364	1569.13	1615.50	-2120.32
20:09	14:39	<i>feedback</i>	1566.00	25.199	1590.45	1615.65	-2120.19
20:10	14:40	feedback	1570.00	21.182	1594.51	1615.69	-2120.12
20:11	14:41	feedback	1575.00	16.079	1599.58	1615.66	-2119.90
20:13	14:43	feedback	1578.00	13.087	1602.63	1615.71	-2119.70
20:15	14:45	feedback	1580.00	11.058	1604.66	1615.71	-2119.82
20:16	14:46	feedback	1585.00	5.993	1609.73	1615.72	-2120.50
						<b>1615.70</b>	<b>-2120.04</b>



**Fig. 5.4.5:** Tie point measurement at the new North Pier in Colombo (#3).

*Measurement #2 (Table 5.4.2, Figs 5.4.3, 5.4.4)*

Instrument:	LaCoste & Romberg gravimeter, G-744 with feedback
Temperature:	49.95°C
Location:	Colombo Harbour, new North Pier, between bollard 5 and 6
Coordinates:	06°57.506'N 79°51.343'E
Height above waterline:	2.10 m
Draft of vessel:	6.30 (between 6.20 and 6.40 m)
Date:	12. July 2017
Conditions:	calm
Abs. gravity:	978121.860 mGal (close to old BGI tie point 000361, pier has been modified!)
Present:	Wolfram Geissler

**Tab. 5.4.2:** Gravity measurements #2 at North Pier in Colombo on 12. July 2017. Cursive marked measurements are not used to calculate the average reading value.

Time [LT]	Time [UTC]	Type	Counter reading [CU]	Feedback [mGal]	Counter reading [mGal]	Total gravity [mGal]	KSS32M gravity [mGal]
07:00	01:30	manual. from right	1591.32		1616.14		
07:01	01:31	manual	1591.26		1616.08		
07:01	01:31	manual	1591.28		1616.10		
07:02	01:31	manual	1591.28		1616.11		
07:03	01:31	manual	1591.32		1616.14		
07:05	01:31	manual	1591.24		1616.06		
07:07	01:37	feedback	1591.24	-0.410	<i>1616.06</i>	1615.65	-2119.69
07:08	01:38	feedback	1591.00	-0.165	<i>1615.82</i>	1615.65	-2120.40
07:09	01:39	feedback	1590.00	0.844	<i>1614.80</i>	1615.65	-2120.13
07:10	01:40	feedback	1589.00	1.841	<i>1613.79</i>	1615.63	-2119.92
07:11	01:41	feedback	1588.00	2.854	<i>1612.77</i>	1615.63	-2120.03
07:12	01:42	feedback	1591.00	-0.105	<i>1615.82</i>	1615.71	-2120.74
07:13	01:43	feedback	1590.00	0.893	<i>1614.80</i>	1615.70	-2119.46
07:14	01:44	feedback	1589.00	1.850	<i>1613.79</i>	1615.64	-2119.93
07:15	01:45	feedback	1592.00	-1.110	<i>1616.83</i>	1615.72	-2120.78
07:16	01:46	feedback	1593.00	-2.167	<i>1617.85</i>	1615.68	-2119.48
07:17	01:47	feedback	1594.00	-3.178	<i>1618.86</i>	1615.69	-2120.26
07:17	01:47	feedback	1593.00	-2.143	<i>1617.85</i>	1615.71	-2120.26
07:18	01:48	feedback	1592.00	-1.103	<i>1616.83</i>	1615.73	-2119.77
07:19	01:49	feedback	1591.00	-0.108	<i>1615.82</i>	1615.71	-2120.66
					<b>1616.11</b>	<b>1615.68</b>	<b>-2120.11</b>

*Measurement #3 (Table 5.4.3, Figs 5.4.3, 5.4.4, 5.4.5)*

Instrument:	LaCoste & Romberg gravimeter, G-744 with feedback
Temperature:	50.0°C
Location:	Colombo Harbour, new North Pier, between bollard 5 and 6
Coordinates:	06°57.493'N 79°51.337'E
Height above waterline:	2.10 m
Draft of vessel:	6.30 (between 6.20 and 6.40 m)
Date:	12. July 2017
Conditions:	calm
Abs. gravity:	978121.860 mGal (close to old BGI tie point 000361, pier has been modified!)
Present:	Ralf Krockner, Konrad Behnke

**Tab. 5.4.3:** Gravity measurements #3 at North Pier in Colombo on 12. July 2017. Cursive marked measurements are not used to calculate the average reading value.

Time [LT]	Time [UTC]	Type	Counter reading [CU]	Feedback [mGal]	Counter reading [mGal]	Total gravity [mGal]	KSS32M gravity [mGal]
08:05	02:35	manual, from right	1591.21		1616.03		
08:08	02:38	manual, from right	1591.21		1616.03		
08:09	02:39	manual, from right	1591.21		1616.03		
08:12	02:42	manual, from left	1591.17		1615.99		
08:13	02:43	manual, from right	1591.28		1616.10		
08:15	02:45	manual, from right	1591.24		1616.06		
08:18	02:48	feedback	1593.00	-2.129	<i>1617.85</i>	1615.72	-2119.52
08:19	02:49	feedback	1592.00	-1.120	<i>1616.83</i>	1615.71	-2121.38
08:21	02:51	feedback	1591.00	-0.145	<i>1615.82</i>	1615.67	-2118.43
08:22	02:52	feedback	1590.00	0.847	<i>1614.80</i>	1615.65	-2121.64
08:23	02:53	feedback	1589.00	1.845	<i>1613.79</i>	1615.63	-2119.22
08:24	02:54	feedback	1588.00	2.850	<i>1612.77</i>	1615.62	-2121.21
08:26	02:56	feedback	1589.00	1.892	<i>1613.79</i>	1615.68	-2119.73
08:28	02:58	feedback	1590.00	0.892	<i>1614.80</i>	1615.70	-2119.98
08:29	02:59	feedback	1591.00	-0.108	<i>1615.82</i>	1615.71	-2120.99
08:30	03:00	feedback	1592.00	-1.121	<i>1616.83</i>	1615.71	-2118.96
08:31	03:01	feedback	1593.00	-2.124	<i>1617.85</i>	1615.73	-2121.05
08:32	03:02	feedback	1592.00	-1.157	<i>1616.83</i>	1615.68	-2119.18
08:33	03:03	feedback	1591.00	-0.154	<i>1615.82</i>	1615.67	-2120.61
					<b>1616.04</b>	<b>1615.68</b>	<b>-2120.14</b>

*Measurement #4 (Table 5.4.4, Fig. 5.4.6)*

Instrument:	LaCoste & Romberg gravimeter, G-744 with feedback
Temperature:	49.9°C
Location:	Colombo, "French Consulate" 000360 (not clear if the right tie point!)
Coordinates:	06° 57.003'N 079° 52.017'E
Date:	17. August 2017
Conditions:	calm
Abs. gravity:	978124.540 mGal
Present:	Ralf Krockner, Konrad Behnkew

**Tab. 5.4.4:** Gravity measurements #4 in Colombo on 17. August 2017. The point is assumed to be the old tie point "French Consulate", but there are some doubts. Cursive marked measurements are not used to calculate the average reading value.

Time [LT]	Time [UTC]	Type	Counter reading [CU]	Feedback [mGal]	Counter reading [mGal]	Total gravity [mGal]
17:10	11:40	feedback	1591.00	-4.370	<i>1615.82</i>	1611.45
17:12	11:42	feedback	1590.00	-3.345	<i>1614.80</i>	1611.46
17:13	11:43	feedback	1589.00	-2.352	<i>1613.79</i>	1611.44
17:14	11:44	feedback	1588.00	-1.346	<i>1612.77</i>	1611.43
17:15	11:45	feedback	1587.00	-0.369	<i>1611.76</i>	1611.39
17:16	11:46	feedback	1586.00	0.652	<i>1610.74</i>	1611.40
17:18	11:48	feedback	1585.00	1.677	<i>1609.73</i>	1611.41
17:19	11:49	feedback	1584.00	2.692	<i>1608.71</i>	1611.41
17:20	11:50	feedback	1583.00	3.665	<i>1607.70</i>	1611.37
17:22	11:52	feedback	1582.00	4.704	<i>1606.69</i>	1611.39
17:24	11:54	feedback	1583.00	3.726	<i>1607.70</i>	1611.43
17:25	11:55	feedback	1584.00	2.710	<i>1608.71</i>	1611.42
17:27	11:57	feedback	1585.00	1.705	<i>1609.73</i>	1611.43
17:28	11:58	feedback	1586.00	0.691	<i>1610.74</i>	1611.44
17:30	12:00	feedback	1587.00	-0.303	<i>1611.76</i>	1611.46
17:31	12:01	feedback	1588.00	-1.317	<i>1612.77</i>	1611.46
17:33	12:03	feedback	1589.00	-2.345	<i>1613.79</i>	1611.44
17:34	12:04	feedback	1590.00	-3.356	<i>1614.80</i>	1611.45
17:35	12:05	feedback	1591.00	-4.342	<i>1615.82</i>	1611.48
17:40	12:10	manual	1587.21		1611.97	
17:41	12:11	manual	1587.15		1611.91	
17:42	12:12	manual	1587.20		1611.96	
17:43	12:13	manual	1587.14		1611.90	
17:44	12:14	manual	1587.21		1611.97	
17:45	12:15	manual	1587.13		1611.89	
					<b>1611.93</b>	<b>1611.43</b>

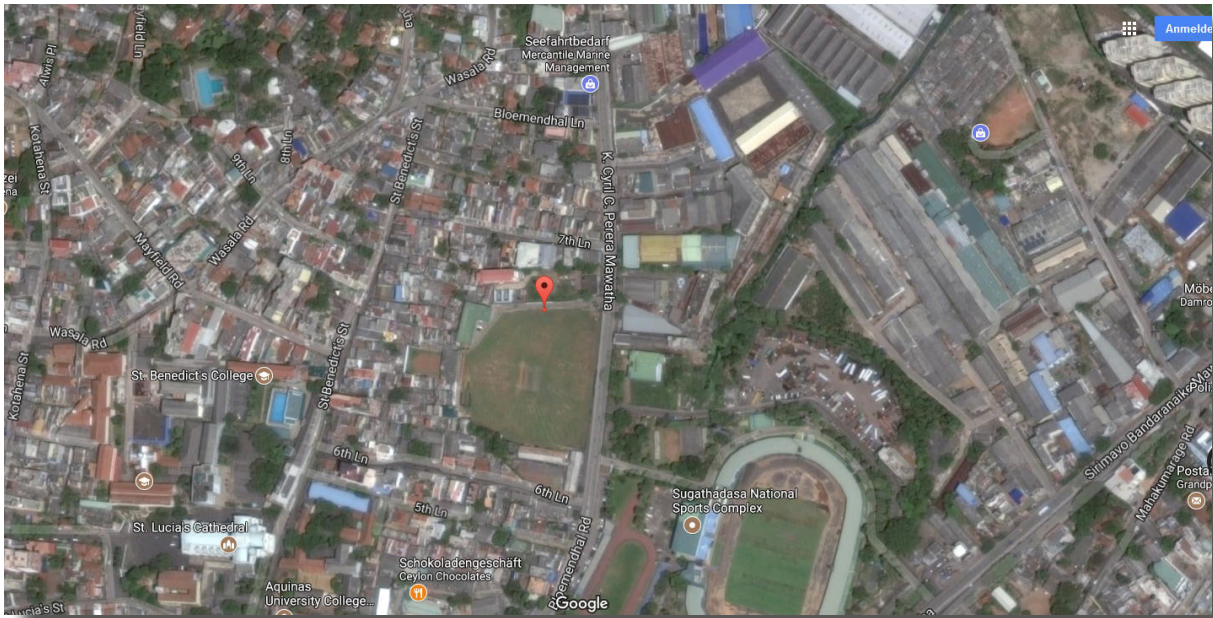

**Fig. 5.4.6:** Location of tie point #4 close to Benedict's College in Colombo. Source: GoogleMaps.

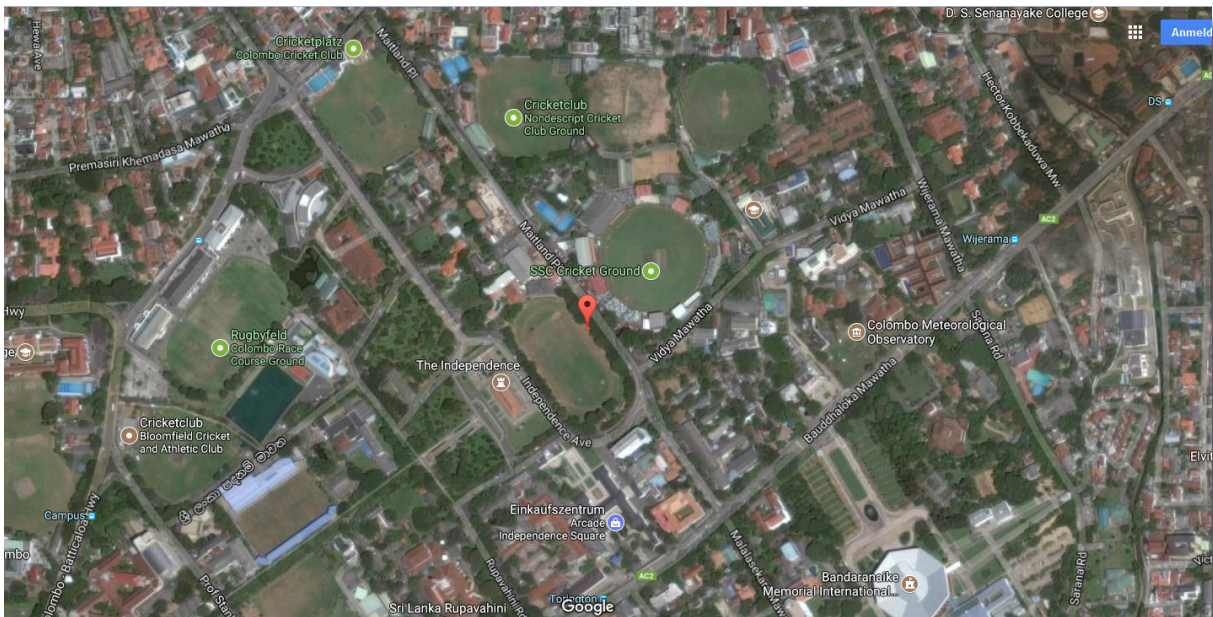

**Fig. 5.4.7:** Location of tie point #5 close to The Independence in Colombo. Source: GoogleMaps.



*Measurement #5 (Table 5.4.5, Fig. 5.4.7)*

Instrument:	LaCoste & Romberg gravimeter, G-744 with feedback
Temperature:	49.9°C
Location:	Colombo, "The Independence" 000363 (not clear if the right tie point!)
Coordinates:	06° 54.303'N 079° 52.116'E
Date:	17. August 2017
Conditions:	calm
Abs. gravity:	978117.240 mGal
Present:	Ralf Krockner, Konrad Behnke

**Tab. 5.4.5:** Gravity measurements #5 in Colombo on 17. August 2017. The point is assumed to be the old tie point 000363, but there are some doubts. Cursive marked measurements are not used to calculate the average reading value.

Time [LT]	Time [UTC]	Type	Counter reading [CU]	Feedback [mGal]	Counter reading [mGal]	Total gravity [mGal]
18:38	13:08	feedback	1587.00	-2.873	<i>1611.76</i>	1608.89
18:40	13:10	feedback	1588.00	-3.875	<i>1612.77</i>	1608.90
18:43	13:13	feedback	1586.00	-1.870	<i>1610.74</i>	1608.87
18:45	13:15	feedback	1585.00	-0.863	<i>1609.73</i>	1608.87
18:47	13:17	feedback	1584.00	0.127	<i>1608.71</i>	1608.84
18:48	13:18	feedback	1583.00	1.137	<i>1607.70</i>	1608.84
18:50	13:20	feedback	1582.00	2.151	<i>1606.69</i>	1608.84
18:52	13:22	feedback	1581.00	3.191	<i>1605.67</i>	1608.86
18:53	13:23	feedback	1582.00	2.192	<i>1606.69</i>	1608.88
18:55	13:25	feedback	1583.00	1.168	<i>1607.70</i>	1608.87
18:56	13:26	feedback	1584.00	0.177	<i>1608.71</i>	1608.89
18:57	13:27	feedback	1585.00	-0.839	<i>1609.73</i>	1608.89
18:59	13:29	feedback	1586.00	-1.838	<i>1610.74</i>	1608.91
19:01	13:31	feedback	1587.00	-2.867	<i>1611.76</i>	1608.89
19:04	13:34	manual	1584.66		1609.38	
19:05	13:35	manual	1584.72		1609.45	
19:06	13:36	manual	1584.66		1609.38	
19:07	13:37	manual	1584.70		1609.43	
19:08	13:38	manual	1584.71		1609.43	
19:09	13:39	manual	1584.69		1609.41	
					<b>1609.41</b>	<b>1608.87</b>

*Measurement #6 (Table 5.4.6, Figs 5.4.3, 5.4.4)*

Instrument:	LaCoste & Romberg gravimeter, G-744 with feedback
Temperature:	49.9°C
Location:	Colombo Harbour, new North Pier, close to bollard 5
Coordinates:	06° 57.492'N 079° 51.330'E
Height above waterline:	2.10 m
Draft of vessel:	6.30 (between 6.20 and 6.40 m)
Date:	17. August 2017
Conditions:	calm, dark
Abs. gravity:	978121.860 mGal (close to old BGI tie point 000361, pier has been modified!)
Present:	Ralf Krockner, Konrad Behnke

**Tab. 5.4.6:** Gravity measurements #6 at North Pier in Colombo on 17. August 2017. Cursive marked measurements are not used to calculate the average reading value.

Time [LT]	Time [UTC]	Type	Counter reading [CU]	Feedback [mGal]	Counter reading [mGal]	Total gravity [mGal]	KSS32M gravity [mGal]
20:28	14:58	feedback	1591.00	-3.064	<i>1615.82</i>	1612.76	-2117.69
20:29	14:59	feedback	1590.00	-2.036	<i>1614.80</i>	1612.77	-2117.21
20:31	15:01	feedback	1589.00	-1.069	<i>1613.79</i>	1612.72	-2117.35
20:33	15:03	feedback	1588.00	-0.067	<i>1612.77</i>	1612.71	-2117.38
20:35	15:05	feedback	1587.00	0.941	<i>1611.76</i>	1612.70	-2117.38
20:37	15:07	feedback	1586.00	1.960	<i>1610.74</i>	1612.70	-2117.39
20:39	15:09	feedback	1585.00	2.992	<i>1609.73</i>	1612.72	-2117.62
20:40	15:10	feedback	1584.00	4.022	<i>1608.71</i>	1612.74	-2117.53
20:41	15:11	feedback	1585.00	3.011	<i>1609.73</i>	1612.74	-2117.53
20:42	15:12	feedback	1586.00	1.996	<i>1610.74</i>	1612.74	-2116.92
20:44	15:14	feedback	1587.00	0.977	<i>1611.76</i>	1612.74	-2117.67
20:45	15:15	feedback	1588.00	-0.033	<i>1612.77</i>	1612.74	-2117.34
20:48	15:18	feedback	1589.00	-1.010	<i>1613.79</i>	1612.78	-2117.58
20:50	15:20	feedback	1590.00	-2.063	<i>1614.80</i>	1612.74	-2117.58
20:51	15:21	feedback	1591.00	-3.018	<i>1615.82</i>	1612.80	-2117.55
20:53	15:23	manual	1588.51		1613.29		
20:54	15:24	manual	1588.35		1613.13		
20:55	15:25	manual	1588.48		1613.26		
20:56	15:26	manual	1588.42		1613.20		
20:57	15:27	manual	1588.47		1613.25		
20:58	15:28	manual	1588.49		1613.27		
					<b>1613.26</b>	<b>1612.74</b>	<b>-2117.45</b>

Because for tie points “French Consulate” and “The Independence” it is not clear, if the measured places actually fit old tie point locations, we will restrict further calculations only on the measurements #3 and #6 carried at the North Pier close to the old tie point 000361 (“Colombo Harbour”).

COLOMBO HARBOUR, BGI Reference Station 000361, North Pier, Colombo, Sri Lanka (Gravity: 978121.860 mgal)

Tie points #1-3 and #6 were chosen next to the ship on the pier between the bollards No. 5 and No. 6 at closest distance to the sea gravity meter on board *Sonne* (Fig. 5.4.4). The vertical distance, of course, could have changed slightly in between the measurements due to the tides (which are not very strong in Colombo) and changing amount of fuel. Fixed vertical distance is from the bottom of the sea gravity meter’s sensor (7.53 m – 0.15 m above keel) to the working deck (9.80 m above keel), which equals to  $R_S = 2.42$  m.

With the measured or calculated (draft of 6.30 m) distance  $R_W$  (working deck – water surface: 3.50 m) and  $L_W$  (land gravity meter – water surface: 2.10 m) we retrieve the instruments vertical distance to

$$D = -R_S - (L_W - R_W) = -2.42 \text{ m} - (3.50 \text{ m} - 2.10 \text{ m}) = -1.02 \text{ m}$$

whereby a negative D has the meaning of a lower altitude of the sea gravimeter, compared to the L&R. Taking the height of the land gravity meter above the sea gravity meter ( $-D = 1.02$  m) we can use the free-air correction to calculate the absolute gravity at the location of the KSS32-M sea gravity meter for measurements #3 and #6:

$$978121.86 \text{ mGal} + 0.3086 \text{ mGal/m} * 1.02 \text{ m} = 978122.17 \text{ mGal}$$

#### *Drift of the KSS32 during the Cruise*

The official values of absolute gravity at point Colombo Harbour is 978121.860 mgal. Since the point were measured before and after the cruise no differences are expected for the absolute gravity. The difference for the same sites determined by the L&R land gravimeter G-744 is 1612.74 mgal (#6) – 1615.68 mgal (#3) = –2.94 mgal, which could be taken as drift of the land gravity meter. The KSS by itself measured

$$\begin{aligned} G_{\text{tot,rel}}(\text{KSS},\#6) - G_{\text{tot,rel}}(\text{KSS},\#3) &= -2117.45 \text{ mgal} - (-2120.14 \text{ mgal}) \\ &= 2.69 \text{ mgal} , \end{aligned}$$

which can be taken as the drift of the KSS gravity meter. The total drift  $\Delta$  of the sea gravity meter in comparison to the land gravity meter during the cruise from 12.07.2017, 03:00 UTC to 17.08.2017, 15:10 UTC amounts to:

$$\Delta = 2.69 \text{ mgal} - (-2.94 \text{ mgal}) = 5.63 \text{ mgal}$$

## 5.5 Marine mammal observation

Emma Hayes<sup>1</sup>, Ophélie Humphrey<sup>1</sup> (not on board),  
Menaka Goonewardena<sup>2</sup>, Marcus Bridge<sup>1</sup>

<sup>1</sup>Gardline  
<sup>2</sup>GTWSC

### 5.5.1 Objectives

Sound is conducted through water approximately 4.5 times faster than through air and is essential for many marine organisms for sensing their environment. This is especially true for marine mammals, since they use sound to communicate, navigate, forage, and for predator avoidance (Richardson *et al.*, 1995). The functional frequency range used by marine mammals varies from 7Hz to 180,000Hz, with baleen whales using the lower frequencies, and toothed whales using higher frequencies (Southall *et al.*, 2007). Marine turtles are another group potentially impacted by seismic activity, as their hearing sensitivity falls in the low frequency range (less than 1kHz; Bartol *et al.*, 1999).

Due to the unique position of Sri Lanka, the waters surrounding the survey area are highly productive and prime habitat for a range of cetacean species (de Vos *et al.*, 2014a). Sri Lanka has an abundance of marine mammals, with around 30 different species known to be found in waters surrounding the island. Of these species, two are classified as Endangered, one as Critically Endangered, two as Vulnerable, and one as Near Threatened on the IUCN Red List (IUCN, 2017). The marine mammal community comprises cetaceans and one sirenian species (*Dugong dugong*) that can be found year-round in shallow waters surrounding the island. Five species of marine turtle can be found in Sri Lanka: the green turtle (*Chelonia midas*), loggerhead turtle (*Caretta caretta*), hawksbill turtle (*Eretmochelys imbricata*), olive ridley turtle (*Lepidochelys olivacea*), and the leatherback turtle (*Dermodochelys coriacea*).

All marine mammal species in Sri Lanka are protected under the Fauna and Flora Protection (Amendment) Act No 22 of 2009 as well as the Fisheries and Aquatic Resources Act No 2 of 1996. Sri Lankan waters fall within the Indian Ocean 'Whale Sanctuary' declared by the International Whaling Commission in 1979, with protection further being extended to all marine mammals in 1994 by the Indian Ocean Marine Affairs Co-operation. This being said, there is currently no legislation regarding mitigation procedures for marine animals during acoustic operations in the waters offshore of Sri Lanka. The Alfred Wegener Institute for Polar and Marine Research (AWI) wished to voluntarily adopt marine mammal mitigation measures during geophysical data acquisition in order to protect marine mammals in the survey area. Therefore, AWI contracted Gardline Geosurvey Ltd. (Gardline) to conduct a marine mammal impact assessment (MMIA) prior to the survey. The aim of the MMIA was to identify the potential impacts to marine mammals in the area from the seismic operations, and determine steps to avoid, remedy or mitigate any negative effects from the operations. The MMIA was further verified by modelling the predicted acoustic propagation to confirm that the proposed mitigation measures were sufficient to avoid injury to marine mammals and turtles. The associated marine mammal mitigation plan (MMMP) was developed based upon best industry practice to minimise the risk of injury and disturbance from seismic surveys and was implemented throughout the geophysical survey. It should be noted that mitigation measures were conducted for marine turtles in addition to marine mammals, therefore these two groups shall hereafter be referred to as 'marine animals'.

### 5.5.2 Work at sea

The survey was run in accordance with the MMMP, as requested by AWI and developed by Gardline. Three dedicated Marine Mammal Observers (MMOs) were required to be present onboard the vessel for the duration of the survey. It was the responsibility of the MMOs to advise upon the operators procedures and conduct observations as outlined below.

As stated in the MMMP, where practically possible, the seismic sources were to be activated during daylight hours, in order to allow for visual observations by the MMOs. Monitoring for marine animals was performed by at least two MMOs for a minimum of 60 minutes prior to the use of the acoustic source. Should marine animals be present within their respective mitigation zone of the acoustic source during this period, then the start was delayed by at least 30 minutes after the last detection, to allow animals to move out of the vicinity. At least two MMOs were required to be on watch whilst the airgun array was active during daylight hours (health and safety permitting), in order to monitor for marine animals. The acoustic source was also shut down if any marine animals were present within the respective mitigation zone during data acquisition. Acquisition would then be re-commenced with a soft start at least 30 minutes after the last detection or after the animal was observed leaving the mitigation zone.

The MMMP also required that a 'soft start' procedure be operated prior to use of the airguns. During this soft start the source volume is built up slowly from a low energy start-up over a period of 20 to 40 minutes before reaching the level required for survey production. It is intended that this slow build up will allow marine animals in the vicinity of the seismic vessel to move away from the area of the airguns.

To avoid any risk of collision, at least one MMO was to be on watch during daytime transits or at any other times of increased vessel speed (i.e. above usual survey speed). If any marine animals were sighted in the vicinity ahead of the vessel and if judged by the MMOs that the animal/s is/are not responsive (i.e. during times of resting, feeding, socialising), the vessel's course was to be altered to avoid collision with the animal. Special attention was to be paid to baleen whales in the vicinity of the vessel, given their greater vulnerability to vessel strikes.

The MMOs carried out dedicated watches for marine animals throughout the daylight hours of the survey (even if operations were not taking place) and completed the relevant recording forms. Watches were carried out from the observation deck, which at a height of 22 m provided an optimal 360° view of the surrounding area. Prior to beginning a watch, the time (UTC) and weather conditions were recorded on the JNCC Location and Effort Form. Weather conditions such as Beaufort wind force, sea state and visibility were noted every hour and whenever a change in conditions occurred. In addition, the start and end times of marine animal watches and the start and end times of operation of the acoustic sources were recorded each day on the JNCC Record of Operations Form.

The primary observation technique used to spot marine animals was to scan the visible area of sea using the naked eye. Binoculars (magnification x10) were used to scan areas of interest such as waves going against the prevailing direction, white water during calm periods, bird activity, bird transiting direction, *etc.* This technique gave both a wide field of view and the ability to have a sufficient range of 3–4 km in ideal conditions.

Identifications were based on a combination of the observer's previous experience, aided by Shirihai and Jarrett (2006).

The JNCC Marine Mammal Recording Forms were available to record sightings made by the MMOs. The information recorded included the date and time, the vessels position, course, depth and seismic activity. The species, number of animals, behaviour, distance from the vessel and direction of travel were also recorded. Any additional information, such as details on the features used to identify the animals and the reaction of the animals to the acoustic source was also noted.

A total of 436 hours and 30 minutes of dedicated marine animal watches were carried out by the MMOs from 12-Jul-2017 to 15-Aug-2017. This includes a total of 3 hours and 53 minutes of dedicated visual pre-shoot watch.

### **5.5.3 Compliance with the MMMP**

As previously mentioned, there is currently no legislation regarding mitigation procedures for marine animals during seismic operations in the waters offshore of Sri Lanka. AWI requested the development of a bespoke MMMP be developed and followed as best practice during the scientific geophysical survey. The MMOs were requested to carry out dedicated watches during the daylight hours of the survey, with specific focus on monitoring the mitigation zone prior to and during seismic data acquisition.

There were three soft starts during the scientific geophysical survey, all of which occurred during the hours of daylight. Full pre-shoot visual watches were conducted prior to all three soft starts. All soft starts were from 20 to 40 minutes in duration.

There were no line turns during the survey during which the airguns remained firing. This being said, there was one occasion when the airguns remained firing after the end of line in order to collect additional data, which was 42 minutes in duration. As the two OBS lines were planned to occur with several days break in between, the airguns stopped firing at the end of line and were recovered.

There was one delay to data acquisition due to a marine animal sighting. The delay occurred 02:00h on 22-Jul-2017 when two pygmy blue whales were observed 2,000 m away from the vessel. The two whales were travelling in variable directions and were present in the mitigation zone from 03:27 h to 03:30 h. The soft start was consequently delayed and commenced at 04:10 h.

There was one shut down of seismic data acquisition due to a marine animal sighting. At 04:25 h, during the aforementioned soft start of the seismic equipment, two pygmy blue whales were observed diving at a distance of 3,000 m. As this observation was outside of the mitigation zone the soft start continued until 04:38 h when full power was reached and data acquisition began. However, at 04:40 h, the two whales resurfaced at a distance of 500 m from the airguns, necessitating a full shut down. The whales were observed leaving the mitigation zone at 04:58 h and the soft start commenced at 05:15 h.

There was one occasion when the mitigation zone for pygmy blue whales and Bryde's whale was extended to 2,000 m following two confirmed sightings of a single species within 24 hours, as advised in the MMMP. On 22-Jul-2017 two confirmed sightings of pygmy blue whale occurred at 02:00 h and 04:25 h. The extended mitigation zone was implemented until 24 hours had elapsed since the last sighting at 05:00 h on 22-Jul-2017, following which the mitigation zone resumed at 1,000 m for pygmy blue whales and Bryde's whales. Although there were other occasions during which more than one sighting of a blue or Bryde's whale occurred within 24 hours, these occurred outside periods of seismic data acquisition and therefore no extension of the mitigation zone was required.

### **5.5.4 Marine Animal Sightings**

There were 62 sightings of marine mammals, sharks and marine turtles throughout the duration of the survey, from 12-Jul-2017 to 17-Aug-2017. The positions of these sightings are listed in Table 5.5.1.

There were 28 sightings of pygmy blue whale (*Balaenoptera musculus brevicauda*) throughout the duration of the survey, a summary of which can be found in Table 5.5.1.

There were three sightings of Bryde's whales (*Balaenoptera edeni*) throughout the duration of the survey. Two sightings occurred on 13-Jul-2017. The first, at 03:20 h, comprised one individual that was observed at a distance of 1,500 m, travelling away from the vessel, and was last sighted at 03:34 h. The second sighting occurred at 04:23 h when one individual was observed 500 m travelling in a variable direction, and was last sighted at 04:30 h. The third sighting of a Bryde's whale was on 22-Jul-2017 at 10:18 h when one individual was observed 2,100 m away, travelling in variable directions, and was last sighted at 10:22 h.

There was one sighting of sperm whale (*Physeter macrocephalus*) during the survey. The sighting occurred at 09:14 h on 24-Jul-2017 when a pod of approximately 20 individuals were observed 4,000 m away from the vessel. Despite the distance these animals were clearly identified as sperm whales as they were emitting blows at a 45° angle, between dives of approximately 40 minutes in duration. The pod was travelling away from the vessel in a westerly direction and was last observed at 11:15 h.

There were 17 sightings of unidentified baleen whale species throughout the duration of the survey. A summary can be found in Table 5.5.1.

There were two sightings of spinner dolphin (*Stenella longirostris*) throughout the duration of the survey. The first occurred on 14-Jul-2017 between 08:18 h and 08:23 h when a pod of approximately 50 individuals were observed 250 m away from the vessel porpoising and swimming fast in variable directions. The second sighting occurred on 31-Jul-2017 at 04:30h where a pod of approximately 30 individuals was observed 2,000 m away from the vessel and was last sighted at 04:43 h.

There was one sighting of striped dolphin (*Stenella coeruleoalba*) during the survey. The sighting occurred at 04:50 h on 14-Aug-2017 when a pod of approximately 8 individuals were observed 30 m in front of the vessel. The pod was travelling towards the vessel in a westerly direction and was last observed at 05:00 h.

There was one sighting of an unidentified dolphin species during the survey. The sighting occurred at 11:20 h on 14-Aug-2017 when an individual dolphin was briefly observed 20 m bow-riding in front of the vessel by a crew member.

There were four sightings of green turtle (*Chelonia mydas*) species during the survey. The first occurred on 13-Jul-2017 at 01:03 h when a green turtle was observed surfacing 15 m away from the vessel. The second sighting occurred on 21-Jul-2017 at 12:04 h when a green turtle was observed surfacing 20 m away from the vessel. The third sighting occurred on 14-Aug-2017 at 05:00 h when a green turtle was observed on the surface approximately 90 m away from the vessel. The fourth sighting occurred the same day at 11:20 h when a green turtle was observed on the surface approximately 5 m away from the vessel.

There were three sightings of unidentified turtle species during the survey. The first occurred on 12-Jul-2017 at 05:40 h when a turtle was observed surfacing 50 m away from the vessel. The second sighting occurred on 27-Jul-2017 at 06:25 h when a turtle was observed surfacing 15 m away from the vessel. The third sighting occurred on 31-Jul-2017 at 06:30 h when a turtle was observed surfacing 10 m away from the vessel.

There were two sightings of juvenile whale sharks (*Rhincodon typus*) during the survey, both of which occurred on 14-Jul-2017. The first individual, observed at 03:42 h, was swimming away from the vessel at a distance of 20 m. The second, encountered at 03:54 h, was swimming at the surface, towards the vessel, at a distance of 10 m.

Tab. 5.5.1: Summary of marine animal sightings.

ON SURVEY						
Species	Date	Number of animals (number of calves)	Latitude	Longitude	Species ID certainty	Mitigation action
Pygmy blue whale ( <i>Balaenoptera musculus brevicauda</i> )	22/07/2017	2 (0)	5° 53.41' N	80° 59.05' E	Definite	Shutdown
Bryde's whale ( <i>Balaenoptera brydei</i> )	22/07/2017	1 (0)	5° 27.40' N	81° 00.03' E	Probable	None
Unidentified baleen whale sp.	22/07/2017	1 (0)	5° 47.99' N	81° 00.01' E	Definite	None
	22/07/2017	1 (0)	5° 47.99' N	81° 00.01' E	Definite	None
	22/07/2017	1 (0)	5° 41.58' N	81° 00.05' E	Definite	None
	22/07/2017	1 (0)	5° 41.58' N	81° 00.05' E	Definite	None
	22/07/2017	1 (0)	5° 36.76' N	81° 00.27' E	Definite	None
	22/07/2017	1 (0)	5° 35.65' N	81° 00.17' E	Definite	None
	22/07/2017	1 (0)	5° 20.51' N	81° 00.03' E	Definite	None
	23/07/2017	1 (0)	4° 05.01' N	81° 00.03' E	Definite	None
	23/07/2017	1 (0)	3° 40.95' N	81° 00.01' E	Definite	None
23/07/2017	1 (0)	3° 26.17' N	81° 00.01' E	Definite	None	
OFF SURVEY						
Species	Date	Number of animals (number of calves)	Latitude	Longitude	Species ID certainty	Mitigation action
Pygmy blue whale ( <i>Balaenoptera musculus brevicauda</i> )	12/07/2017	1 (0)	5° 43.92' N	80° 03.84' E	Probable	None
	12/07/2017	1 (0)	5° 38.29' N	80° 08.93' E	Probable	None
	13/07/2017	1 (0)	5° 40.68' N	80° 50.69' E	Probable	None
	13/07/2017	1 (0)	5° 38.80' N	80° 50.69' E	Definite	None
	22/07/2017	2 (0)	5° 52.18' N	81° 03.27' E	Definite	Delay
	22/07/2017	1 (0)	5° 52.07' N	81° 00.67' N	Probable	None
	25/07/2017	2 (0)	4° 16.27' N	81° 00.76' N	Probable	None
	25/07/2017	2 (0)	4° 16.27' N	81° 00.76' N	Probable	None
	26/07/2017	3 (0)	5° 49.16' N	81° 01.49' E	Probable	None
	26/07/2017	2 (0)	5° 52.65' N	81° 01.49' E	Probable	None
	26/07/2017	2 (0)	5° 52.65' N	81° 01.49' E	Probable	None
	26/07/2017	1 (0)	5° 52.65' N	81° 01.49' E	Definite	None
	26/07/2017	1 (0)	5° 52.73' N	81° 00.33' E	Definite	None
	31/07/2017	1 (0)	5° 58.46' N	81° 27.87' E	Probable	None
	14/08/2017	1 (0)	6° 14.33' N	81° 55.82' E	Probable	None
	14/08/2017	1 (0)	6° 14.33' N	81° 55.82' E	Probable	None
	14/08/2017	1 (0)	6° 17.18' N	81° 55.82' E	Probable	None
	14/08/2017	1 (0)	6° 16.46' N	81° 53.44' E	Probable	None
	14/08/2017	2 (0)	6° 16.46' N	81° 53.44' E	Definite	None
	14/08/2017	1 (0)	6° 16.46' N	81° 53.44' E	Definite	None
	14/08/2017	1 (0)	6° 17.18' N	81° 55.82' E	Definite	None
	14/08/2017	1 (0)	6° 17.18' N	81° 55.82' E	Definite	None
	14/08/2017	1 (0)	6° 17.18' N	81° 55.82' E	Definite	None
14/08/2017	1 (0)	6° 17.18' N	81° 55.82' E	Definite	None	
14/08/2017	1 (0)	6° 05.98' N	81° 46.52' E	Definite	None	
14/08/2017	1 (0)	6° 05.98' N	81° 46.52' E	Probable	None	
14/08/2017	1 (0)	6° 02.21' N	81° 46.52' E	Probable	None	
Bryde's whale	13/07/2017	1 (0)	5° 28.64' N	80° 50.70' E	Probable	None



<i>(Balaenoptera brydei)</i>	13/07/2017	1 (0)	5° 17.96' N	80° 50.69' E	Definite	None
Unidentified baleen whale sp.	13/07/2017	1 (0)	5° 29.84' N	80° 50.69' E	Definite	None
	22/07/2017	1 (0)	5° 52.00' N	81° 00.00' E	Definite	None
	22/07/2017	1 (0)	5° 51.21' N	81° 00.08' E	Definite	None
	22/07/2017	1 (0)	5° 50.61' N	81° 00.02' N	Definite	None
	26/07/2017	1 (0)	5° 52. 73' N	81° 00.33' E	Definite	None
	28/07/2017	1 (0)	0° 26.36' S	81° 09.30' E	Definite	None
	14/08/2017	3 (0)	5° 23.23' N	81° 55.82' E	Definite	None
Sperm whale ( <i>Physeter macrocephalus</i> )	24/07/2017	20 (0)	3° 00.70' N	81° 00.75'E	Definite	None
Spinner dolphin ( <i>Stenella longirostris</i> )	14/07/2017	50 (0)	0° 08.24' N	80° 50.69' E	Definite	None
	31/07/2017	30 (0)	5° 12.44' N	81° 18.61' E	Definite	None
Striped dolphin ( <i>Stenella coeruleoalba</i> )	14/08/2017	8 (0)	5° 47.10' N	81° 55.83' E	Definite	None
Unidentified dolphin sp.	14/08/2017	1 (0)	0° 52.25' N	81° 46.52' E	Definite	None
Green turtle ( <i>Chelonia mydas</i> )	13/07/2017	1 (0)	5° 40.52' N	80° 52.70' E	Definite	None
	21/07/2017	1 (0)	4° 27.53' N	80° 59.99' E	Probable	None
	14/08/2017	1 (0)	5° 47.10' N	81° 55.83' E	Probable	None
	14/08/2017	1 (0)	0° 56.33' N	81° 46.52' E	Probable	None
Unidentified turtle sp.	12/07/2017	1 (0)	6° 53.43' N	79° 38.93' E	Definite	None
	27/07/2017	1 (0)	3° 09.82' N	81° 09.30' E	Definite	None
	31/07/2017	1 (0)	5° 32.52' N	81° 18.61' E	Definite	None
Whale shark ( <i>Rhincodon typus</i> )	14/07/2017	1 (0)	1° 01.20' N	80° 50.69' E	Definite	None
	14/07/2017	1 (0)	1° 01.20' N	80° 50.69' E	Definite	None

### 5.5.5 Marine Animal Detectability and Encounters

There are a number of factors that may have influenced the detection of marine animals within the survey area. Weather can affect the ability to detect marine animals in a number of ways, with increasing sea state, wind force and decreasing visibility reducing the detection probability of marine animals (Forney, 2000). Weather conditions recorded during the survey were on the whole moderate. The most prominent factor that may have affected detections prior to and during seismic operations was the often rough sea state as a result of a high (>4) Beaufort wind force. During other periods of the survey the occasional poor visibility and large swell may also have affected detections. The spatio-temporal distribution and high mobility of marine animals may also have had an effect on detection. Many species of marine animal migrate at certain times of the year, primarily in relation to prey abundance and distribution, breeding opportunities and availability of space (Stern, 2002; Plotkin, 2003). In the survey area, the distribution of marine animals is seasonally variable (de Vos *et al.*, 2014b), therefore certain species may not have been present, or present in abundance, in the area during the survey period.

Little marine animal research has been carried out in the waters offshore of Sri Lanka during the time period surveyed. Research surveys carried out have recorded 30 of species of cetaceans and five species of marine turtle as present with some seasonal variability. It was therefore anticipated that marine animal sightings were possible, and as such MMO duties were carried out during all acoustic data acquisition in daylight hours. During the scientific geophysical survey, from 12-Jul-2017 to 17-Aug-2017, there were 60 sightings of marine animals. Species observed comprised pygmy blue whale, Bryde's whale, sperm whale, spinner dolphin, striped dolphin, and green turtle, all of which are to be expected in the waters of Sri Lanka. The

majority of sightings occurred on the continental slope, with pygmy blue whale being the most commonly sighted species. Blue whales have been recorded year-round off the coast of Sri Lanka (de Vos *et al.*, 2014b), suggesting that there is a resident population in the area and that there is sufficient food in the area to offset the need to migrate. The peak numbers of pygmy blue whale in Sri Lanka are usually recorded in March and April and the lowest numbers are in June and July. The sightings recorded as part of this survey therefore provide valuable data in confirming the presence of numerous pygmy blue whales off southern Sri Lanka during the low season.

## 5.6 Acoustic doppler current profiler (ADCP)

Ralf Krockner<sup>1</sup>

<sup>1</sup>AWI

On board *Sonne* two acoustic doppler current profiler (ADCP) of type Ocean Surveyor from Teledyne RD Instruments are installed. The first one operates on 38 kHz, the second one on 75 kHz. Both systems operated most of the time and continuously except during OBS recovery.

The measurements were executed for base research and are not related to other efforts of the cruise.

## 6. DATA AND SAMPLE STORAGE AND AVAILABILITY

Tabea Altenbernd<sup>1</sup>, Ralf Krockner<sup>1</sup>, Wolfram Geissler<sup>1</sup>, Graeme Eagles<sup>1</sup> (not on board)

<sup>1</sup>AWI

### *Magnetics*

Raw gravity data recorded with the towed and shipboard magnetometer systems are archived at geophysics section at AWI and at NIPR, respectively.

### *Seismics*

All navigation files, station protocols, raw data (s2x, 6d6 or pseggy-format), and processed segy files of the two refraction seismic profiles are archived at the geophysics section at AWI. Seismic reflection data are also archived at the geophysics section at AWI.

### *Multibeam*

The Data format for recording is Simrad Multibeam Processing Format where at two types of files were generated: files with extension \*.all contain targets and \*.wcd contain water column data. A format description can be found at <http://hdl.handle.net/10013/epic.37979>. In complete 747 target files and 746 water column files were recorded, covering a time period of 60 minutes each. They amount to uncompressed / compressed size of 29.6 GB / 14.9 GB (\*.all) and 61.7 GB / 50.7 GB (\*.wcd). The files compressed applying gnu-zip are archived in PANGAEA network with DOI: <https://doi.pangaea.de/10.1594/PANGAEA.881319>. Public data download is temporarily prohibited until primary scientific work is published.

Multibeam echo sounder data were delivered to the cooperation partners from Sri Lanka. Edited data will also be published in PANGAEA network to be additional level 1 dataset. CTD data will be published in PANGAEA network.

### *PARASOUND*

PARASOUND PHF and SLF data are archived at geophysics section at AWI. Meta data will be made available in PANGAEA.

### *Gravity*

Raw data are stored as comma separated values into ASCII files covering time period of one hour per file. 837 files were generated during the cruise. First 21 files (1719011.csv to 1719107.csv) from day of installation do not consist of input data from ship. The file sizes amount to 454.5 MB at all. In the present, the data will not be published in public access database until primary scientific work has been finished.

### *ADCP*

549 files with size of 4.68 GB of 38 kHz sounder and 573 files with size of 5.75 GB of 75 kHz sounder have been recorded. Both datasets (38 kHz data and 75 kHz data) will be published without restrictions in PANGAEA database. All data are combined with gnu-tar to one archive and compressed applying gnu-zip.

## **7. ACKNOWLEDGEMENTS**

We thank the Captain Oliver Meyer and the crew of *Sonne* for their professional and friendly support of the scientific work at sea. Their hard work, high level of experience, great flexibility and willingness to help, as well as the pleasant working atmosphere on board, contributed directly to the success of the SO258 leg 2 expedition. We are also grateful to the German Federal Ministry of Education and Research for continuing support of marine research. Additional funding was provided by AWI Bremerhaven and NIPR Tokyo. Much appreciated support has been given by the Projektträger Jülich, Leitstelle Deutsche Forschungsschiffe in Hamburg, and Briesse Schifffahrts GmbH & Co. KG. Furthermore, we thank the German instrument pool for amphibian seismology (DEPAS) for providing instruments and technical support. We thank all unnamed people in our institutes and somewhere else that made this cruise to a successful expedition. Lastly, we would also like to thank the German Ministry of Foreign Affairs and the Embassy of Germany in Colombo for acquiring the necessary research permits.

## 8. REFERENCES

- Bartol SM, Musick JA, Lenhardt ML (1999) Auditory evoked potentials of the loggerhead sea turtle (*Caretta caretta*). *Copeia*, 3, 836-40.
- de Vos A, Pattiaratchi CB, Wijeratne EMS (2014a) Surface circulation and upwelling patterns around Sri Lanka. *Biogeosciences*, 11, 5909-5930.
- de Vos A, Pattiaratchi CB, Harcourt RG (2014b) Inter-annual variability in blue whale distribution off southern Sri Lanka between 2001 and 2012. *Marine Science & Engineering*, 2(3), 534-550.
- Forney KA (2000) Environmental models of cetacean abundance: reducing uncertainty in population trends. *Conservation Biology*, 14(5), 1271-1286.
- International Association of Geomagnetism and Aeronomy Working Group V-MOD (2010) International Geomagnetic Reference Field: The eleventh generation. *Geophysical Journal International*, 183, 1216-1230, doi:10.1111/j.1365-246X.2010.04804.x.
- Isezaki N (1986) A new shipboard three-component magnetometer. *Geophysics*, 51, 1992-1998, doi:10.1190/1.1442054.
- IUCN (2017) IUCN Red List. [Online] Available at: <http://www.iucnredlist.org/> [Accessed 25 April 2017].
- Krishna KS, Bull JM, Ishizuka O, Scrutton RA, Jaishankar S, Banakar VK (2014) Growth of the Afanasy Nikitin seamount and its relationship with the 85-degree E Ridge, northeastern Indian Ocean. *Journal of Earth System Science*, 123(1), 33-47.
- Plotkin P (2003) Adult migration and habitat use. In PL Lutz, JA Musick & J Vyneken, eds. *The Biology of Sea Turtle*. 2nd ed. Florida: CRC Press Ltd.
- Richardson WJ, Greene CR, Malme CI, Thompson DH (1995) *Marine Mammals and Noise*. San Diego, USA: Academic Press.
- Shirihai H, Jarrett B (2006) *Whales, Dolphins and Seals. A field guide to the marine mammals of the world*. A&C Black Publishers.
- Southall BL, Bowles AE, Ellison WT, Finneran, JJ, Gentry RL, Green CR, Kastak D, Ketten DR, Miller JH, Nachtigall PE, Richardson WJ, Thomas JA, Tyack PL (2007) Marine Mammal Noise Exposure Criteria: Initial Scientific Recommendations. *Aquatic Mammals*, 33(7).
- Stern J (2002) Migration and movement patterns. In WF Perrin, B Wursig & JGM Thewissen, eds. *Marine Mammals*. San Diego, USA: Academic Press. pp.742-49.
- Thébault E. et al. (2015) International Geomagnetic Reference Field: the 12th generation. *Earth, Planets and Space*, 67, 79, [doi.org/10.1186/s40623-015-0228-9](https://doi.org/10.1186/s40623-015-0228-9).

## **APPENDIX**

### **A.1 STATION LIST**

## A.1 STATION LIST

Station	Date	Time	Latitude	Longitude	Depth (m)	Gear	Action	Comments
SO258/2_1-1	12.07.17	09:50	5,58135	80,20202	3829	CTD	station start	
SO258/2_1-1	12.07.17	09:56	5,58138	80,20182	3828	CTD	station start	
SO258/2_1-1	12.07.17	11:07	5,58012	80,2034	3825	CTD	at depth	
SO258/2_1-1	12.07.17	12:12	5,57942	80,20417		CTD	station end	
SO258/2_1-1	12.07.17	12:13	5,57943	80,2041		CTD	station end	
SO258/2_1-2	12.07.17	12:24	5,57887	80,20492		PAM	station start	
SO258/2_1-2	12.07.17	12:25	5,57852	80,20527		PAM	station start	
SO258/2_1-2	12.07.17	14:10	5,57113	80,21083		PAM	station end	
SO258/2_1-2	12.07.17	14:21	5,57108	80,21087		PAM	station end	
SO258/2_1-3	12.07.17	14:23	5,5711	80,21085		PAM	station start	
SO258/2_1-3	12.07.17	14:29	5,57083	80,2111		PAM	station start	
SO258/2_1-3	12.07.17	15:59	5,56493	80,21503		PAM	station end	
SO258/2_1-3	12.07.17	16:03	5,56493	80,21498		PAM	station end	
SO258/2_1-4	12.07.17	16:04	5,56492	80,215		PAM	station start	
SO258/2_1-4	12.07.17	16:11	5,56483	80,21507		PAM	station start	
SO258/2_1-4	12.07.17	17:41	5,56038	80,2182		PAM	station end	
SO258/2_1-4	12.07.17	17:44	5,5604	80,21823		PAM	station end	
SO258/2_1-5	12.07.17	17:53	5,56038	80,21828		PAM	station start	
SO258/2_1-5	12.07.17	17:56	5,55975	80,21868		PAM	station start	
SO258/2_1-5	12.07.17	19:28	5,55577	80,22085		PAM	station end	
SO258/2_1-5	12.07.17	19:35	5,55568	80,22082		PAM	station end	
SO258/2_2-1	12.07.17	23:08	5,67557	80,87717	2323	MAG	station start	
SO258/2_2-1	12.07.17	23:17	5,67648	80,8701	2253	MAG	station start	
SO258/2_2-1	15.07.17	01:03	-3,06978	80,8462	4986	MAG	station end	
SO258/2_2-1	15.07.17	01:52	-3,10117	80,84523	4897	MAG	station start	
SO258/2_2-1	15.07.17	03:05	-3,00063	80,84437	4979	MAG	profile start	
SO258/2_2-1	20.07.17	17:41	2,73613	81,00072	4398	MAG	profile end	
SO258/2_2-1	20.07.17	18:09	2,75378	81,00655	4397	MAG	station end	
SO258/2_2-1	20.07.17	18:10	2,75422	81,00648	4397	MAG	station end	
SO258/2_3-3	20.07.17	20:48	3,00842	81,00203	4370	XSV	station start	
SO258/2_3-3	20.07.17	20:48	3,00843	81,00205	4370	XSV	station start	
SO258/2_3-3	20.07.17	21:00	3,01628	81,0088	4371	XSV	station end	
SO258/2_4-1	22.07.17	00:30	5,86965	81,05453	528	SEISSRC	station start	
SO258/2_4-1	22.07.17	02:38	5,8852	80,9991	421	SEISSRC	profile start	
SO258/2_4-1	23.07.17	21:50	2,43268	81	4443	SEISSRC	profile end	
SO258/2_4-1	23.07.17	23:59	2,35625	80,92107	4456	SEISSRC	station end	

A.1 Station List

Station	Date	Time	Latitude	Longitude	Depth (m)	Gear	Action	Comments
SO258/2_5-1	24.07.17	03:00	2,86112	81,00255	4394	SEISOBR	station start	
SO258/2_6-1	26.07.17	11:26	5,88102	81,02328	478	MAG	station start	
SO258/2_6-1	26.07.17	11:26	5,88102	81,02328	478	MAG	station start	
SO258/2_6-1	26.07.17	13:00	5,83377	81,1549	749	MAG	profile start	
SO258/2_6-1	29.07.17	01:00	-3,07985	81,34033	5077	MAG	station end	
SO258/2_6-1	29.07.17	03:21	-3,0913	81,40487	5087	MAG	station start	
SO258/2_6-1	29.07.17	04:10	-3,0835	81,31068	5068	MAG	profile start	
SO258/2_6-1	01.08.17	01:22	3,51712	82,4829	4248	MAG	profile end	
SO258/2_6-1	01.08.17	01:58	3,49142	82,45405	4257	MAG	station end	
SO258/2_6-1	01.08.17	02:04	3,49013	82,44997	4257	MAG	station end	
SO258/2_7-1	01.08.17	03:48	3,3207	82,62663	4266	SEISOBR	station start	
SO258/2_8-1	02.08.17	00:28	1,31192	84,45315	4449	SEISTR	station start	
SO258/2_8-1	02.08.17	03:42	1,25785	84,38087	4455	SEISTR	station end	
SO258/2_9-1	02.08.17	03:43	1,25763	84,38058	4727	SEISOBR	station start	
SO258/2_9-1	02.08.17	04:04	1,24552	84,36237	4703	SEISOBR	profile start	
SO258/2_9-1	02.08.17	05:30	1,19358	84,2816	4470	SEISOBR	profile end	
SO258/2_10-1	02.08.17	06:12	1,21248	84,24122	4473	SEISOBR	profile start	
SO258/2_10-1	03.08.17	21:00	3,63818	82,37522	4251	SEISOBR	profile end	
SO258/2_10-1	03.08.17	21:00	3,63878	82,37475	4249	SEISOBR	station end	
SO258/2_11-1	03.08.17	21:24	3,64442	82,3462	4259	SEISSRC	station start	
SO258/2_11-1	03.08.17	21:46	3,64622	82,32587	4251	SEISSRC	station end	
SO258/2_11-1	03.08.17	22:31	3,64565	82,28393	4273	SEISSRC	station end	
SO258/2_11-1	04.08.17	01:29	3,6491	82,11007	4255	SEISSRC	station end	
SO258/2_11-1	04.08.17	01:33	3,64892	82,10645	4257	SEISSRC	station end	
SO258/2_12-2	04.08.17	07:18	3,31863	82,62942		CTD	station start	
SO258/2_12-2	04.08.17	07:20	3,31857	82,62937		CTD	station start	
SO258/2_12-2	04.08.17	08:28	3,3187	82,62945	4264	CTD	at depth	
SO258/2_12-2	04.08.17	09:20	3,31863	82,6294	4264	CTD	station end	
SO258/2_12-3	04.08.17	09:24	3,31857	82,628	4267	XSV	station start	
SO258/2_12-3	04.08.17	09:25	3,3185	82,62733	4264	XSV	station start	
SO258/2_12-3	04.08.17	09:38	3,3169	82,6182	4265	XSV	station start	
SO258/2_12-3	04.08.17	09:48	3,31627	82,61208	4209	XSV	station end	
SO258/2_12-4	04.08.17	09:52	3,31622	82,61185		SEISOBR	station start	
SO258/2_12-23	06.08.17	02:47	1,49195	84,0162	4430	SEISOBR	station end	
SO258/2_13-1	06.08.17	02:48	1,4919	84,01622	4432	MAG	station start	
SO258/2_13-1	06.08.17	03:23	1,47377	83,99927	4432	MAG	station start	

Station	Date	Time	Latitude	Longitude	Depth (m)	Gear	Action	Comments
SO258/2_13-1	06.08.17	04:38	1,41298	83,86875	4448	MAG	profile start	
SO258/2_13-1	12.08.17	22:50	2,72008	83,11123	4301	MAG	station end	
SO258/2_13-1	16.08.17	15:36	5,62852	80,04742	3512	MAG	station end	
SO258/2_13-3	08.08.17	18:48	-3,00032	81,46515	5058	CTD	station start	
SO258/2_13-4	08.08.17	18:59	-3,01402	81,4651	5057	CTD	station start	
SO258/2_14-1	13.08.17	02:30	2,7454	83,0593		SEISOBR	station end	

#### **Gear abbreviations Gear**

CTD	CTD
MAG	Magnetometer
PAM	Passive Acoustic Monitoring System / Release Unit Test
SEISOBR	Seismic Ocean Bottom Receiver
SEISSRC	Seismic Source
SEISTR	Seismic Towed Receiver
XSV	Expendable Sound Velocimeter



Die **Berichte zur Polar- und Meeresforschung** (ISSN 1866-3192) werden beginnend mit dem Band 569 (2008) als Open-Access-Publikation herausgegeben. Ein Verzeichnis aller Bände einschließlich der Druckausgaben (ISSN 1618-3193, Band 377-568, von 2000 bis 2008) sowie der früheren **Berichte zur Polarforschung** (ISSN 0176-5027, Band 1-376, von 1981 bis 2000) befindet sich im electronic Publication Information Center (**ePIC**) des Alfred-Wegener-Instituts, Helmholtz-Zentrum für Polar- und Meeresforschung (AWI); see <http://epic.awi.de>. Durch Auswahl "Reports on Polar- and Marine Research" (via "browse"/"type") wird eine Liste der Publikationen, sortiert nach Bandnummer, innerhalb der absteigenden chronologischen Reihenfolge der Jahrgänge mit Verweis auf das jeweilige pdf-Symbol zum Herunterladen angezeigt.

The **Reports on Polar and Marine Research** (ISSN 1866-3192) are available as open access publications since 2008. A table of all volumes including the printed issues (ISSN 1618-3193, Vol. 377-568, from 2000 until 2008), as well as the earlier **Reports on Polar Research** (ISSN 0176-5027, Vol. 1-376, from 1981 until 2000) is provided by the electronic Publication Information Center (**ePIC**) of the Alfred Wegener Institute, Helmholtz Centre for Polar and Marine Research (AWI); see URL <http://epic.awi.de>. To generate a list of all Reports, use the URL <http://epic.awi.de> and select "browse"/"type" to browse "Reports on Polar and Marine Research". A chronological list in declining order will be presented, and pdf-icons displayed for downloading.

#### **Zuletzt erschienene Ausgaben:**

**714 (2017)** The Expedition SO258/2 of the Research Vessel SONNE to the central Indian Ocean in 2017, edited by Wolfram Geissler

**713 (2017)** The Expedition PS102 of the Research Vessel POLARSTERN to the Atlantic Ocean in 2016, edited by Karen Wiltshire, Eva-Maria Brodte, Annette Wilson and Peter Lemke

**712 (2017)** The Expedition PS104 of the Research Vessel POLARSTERN to the Amundsen Sea in 2017, edited by Karsten Gohl

**711 (2017)** Mid-Range forecasting of the German Waterways streamflow based on hydrologic, atmospheric and oceanic data by Monica Ionita

**710 (2017)** The Expedition PS103 of the Research Vessel POLARSTERN to the Weddell Sea in 2016/2017, edited by Olaf Boebel

**709 (2017)** Russian-German Cooperation: Expeditions to Siberia in 2016, edited by Pier Paul Overduin, Franziska Blender, Dmitry Y. Bolshiyarov, Mikhail N. Grigoriev, Anne Morgenstern, Hanno Meyer

**708 (2017)** The role of atmospheric circulation patterns on the variability of ice core constituents in coastal Dronning Maud Land, Antarctica by Kerstin Schmidt

**707 (2017)** Distribution patterns and migratory behavior of Antarctic blue whales by Karolin Thomisch

**706 (2017)** The Expedition PS101 of the Research Vessel POLARSTERN to the Arctic Ocean in 2016, edited by Antje Boetius and Autun Purser

**705 (2017)** The Expedition PS100 of the Research Vessel POLARSTERN to the Fram Strait in 2016, edited by Torsten Kanzow

**704 (2016)** The Expeditions PS99.1 and PS99.2 of the Research Vessel POLARSTERN to the Fram Strait in 2016, edited by Thomas Soltwedel

**703 (2016)** The Expedition PS94 of the Research Vessel POLARSTERN to the central Arctic Ocean in 2015, edited by Ursula Schauer

#### **Recently published issues:**



**ALFRED-WEGENER-INSTITUT**  
HELMHOLTZ-ZENTRUM FÜR POLAR-  
UND MEERESFORSCHUNG

**BREMERHAVEN**

Am Handelshafen 12  
27570 Bremerhaven  
Telefon 0471 4831-0  
Telefax 0471 4831-1149  
[www.awi.de](http://www.awi.de)

