

This PDF is available at <http://nap.edu/11886>

SHARE

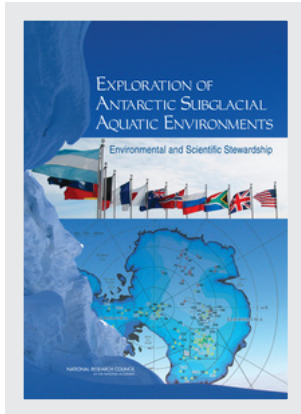

## Exploration of Antarctic Subglacial Aquatic Environments: Environmental and Scientific Stewardship (2007)

### DETAILS

---

162 pages | 7 x 10 | PAPERBACK

ISBN 978-0-309-10635-1 | DOI 10.17226/11886

### CONTRIBUTORS

---

Committee on Principles of Environmental Stewardship for the Exploration and Study of Subglacial Environments; Polar Research Board; Division on Earth and Life Studies; National Research Council

### SUGGESTED CITATION

---

National Research Council 2007. *Exploration of Antarctic Subglacial Aquatic Environments: Environmental and Scientific Stewardship*. Washington, DC: The National Academies Press. <https://doi.org/10.17226/11886>.

GET THIS BOOK

FIND RELATED TITLES

Visit the National Academies Press at [NAP.edu](http://NAP.edu) and login or register to get:

---

- Access to free PDF downloads of thousands of scientific reports
- 10% off the price of print titles
- Email or social media notifications of new titles related to your interests
- Special offers and discounts



Distribution, posting, or copying of this PDF is strictly prohibited without written permission of the National Academies Press. (Request Permission) Unless otherwise indicated, all materials in this PDF are copyrighted by the National Academy of Sciences.

Copyright © National Academy of Sciences. All rights reserved.

# EXPLORATION OF ANTARCTIC SUBGLACIAL AQUATIC ENVIRONMENTS

Environmental and Scientific Stewardship

Committee on Principles of Environmental Stewardship for the  
Exploration and Study of Subglacial Environments

Polar Research Board

Division of Earth and Life Studies

NATIONAL RESEARCH COUNCIL  
*OF THE NATIONAL ACADEMIES*

THE NATIONAL ACADEMIES PRESS  
Washington, D.C.  
**[www.nap.edu](http://www.nap.edu)**

THE NATIONAL ACADEMIES PRESS 500 Fifth Street, N.W. Washington, DC 20001

NOTICE: The project that is the subject of this report was approved by the Governing Board of the National Research Council, whose members are drawn from the councils of the National Academy of Sciences, the National Academy of Engineering, and the Institute of Medicine. The members of the committee responsible for the report were chosen for their special competences and with regard for appropriate balance.

This study was supported by Contract/Grant No. ANT-0531226 between the National Academy of Sciences and the National Science Foundation. Any opinions, findings, conclusions, or recommendations expressed in this publication are those of the author(s) and do not necessarily reflect the views of the organizations or agencies that provided support for the project.

International Standard Book Number-13: 978-0-309-10635-1

International Standard Book Number-10: 0-309-10635-4

Additional copies of this report are available from the National Academies Press, 500 Fifth Street, N.W., Lockbox 285, Washington, DC 20055; (800) 624-6242 or (202) 334-3313 (in the Washington metropolitan area); Internet, <http://www.nap.edu>

Cover design by Michael Dudzik, the National Academies Press.

Copyright 2007 by the National Academy of Sciences. All rights reserved.

Printed in the United States of America

# THE NATIONAL ACADEMIES

## *Advisers to the Nation on Science, Engineering, and Medicine*

The **National Academy of Sciences** is a private, nonprofit, self-perpetuating society of distinguished scholars engaged in scientific and engineering research, dedicated to the furtherance of science and technology and to their use for the general welfare. Upon the authority of the charter granted to it by the Congress in 1863, the Academy has a mandate that requires it to advise the federal government on scientific and technical matters. Dr. Ralph J. Cicerone is president of the National Academy of Sciences.

The **National Academy of Engineering** was established in 1964, under the charter of the National Academy of Sciences, as a parallel organization of outstanding engineers. It is autonomous in its administration and in the selection of its members, sharing with the National Academy of Sciences the responsibility for advising the federal government. The National Academy of Engineering also sponsors engineering programs aimed at meeting national needs, encourages education and research, and recognizes the superior achievements of engineers. Dr. Charles M. Vest is president of the National Academy of Engineering.

The **Institute of Medicine** was established in 1970 by the National Academy of Sciences to secure the services of eminent members of appropriate professions in the examination of policy matters pertaining to the health of the public. The Institute acts under the responsibility given to the National Academy of Sciences by its congressional charter to be an adviser to the federal government and, upon its own initiative, to identify issues of medical care, research, and education. Dr. Harvey V. Fineberg is president of the Institute of Medicine.

The **National Research Council** was organized by the National Academy of Sciences in 1916 to associate the broad community of science and technology with the Academy's purposes of furthering knowledge and advising the federal government. Functioning in accordance with general policies determined by the Academy, the Council has become the principal operating agency of both the National Academy of Sciences and the National Academy of Engineering in providing services to the government, the public, and the scientific and engineering communities. The Council is administered jointly by both Academies and the Institute of Medicine. Dr. Ralph J. Cicerone and Dr. Charles M. Vest are chair and vice chair, respectively, of the National Research Council.

[www.national-academies.org](http://www.national-academies.org)



**COMMITTEE ON PRINCIPLES OF ENVIRONMENTAL STEWARDSHIP FOR  
THE EXPLORATION AND STUDY OF SUBGLACIAL ENVIRONMENTS**

**JOHN E. HOBBIE** (Chair), Marine Biological Laboratory, Woods Hole,  
Massachusetts

**AMY BAKER**, Technical Administrative Services, Littleton, Colorado

**GARRY CLARKE**, The University of British Columbia, Vancouver, Canada

**PETER T. DORAN**, University of Illinois at Chicago, Earth and Environmental  
Sciences

**DAVID KARL**, University of Hawaii at Manoa, School of Ocean and Earth Science,  
Honolulu

**BARBARA METHÉ**, The Institute for Genomic Research, Rockville, Maryland

**HEINZ MILLER**, Alfred-Wegener-Institute for Polar and Marine Research, Germany

**SAMUEL B. MUKASA**, University of Michigan, Ann Arbor

**MARGARET RACE**, SETI Institute, Lafayette, California

**WARWICK VINCENT**, Département de Biologie, Université Laval, Québec, Canada

**DAVID WALTON**, British Antarctic Survey, Cambridge, United Kingdom

**JAMES WHITE**, University of Colorado, Boulder

**National Research Council Staff**

**MARIA UHLE**, Study Director

**PAUL CUTLER**, Study Director until June 2006

**RACHAEL SHIFLETT**, Senior Program Assistant

## POLAR RESEARCH BOARD

ROBIN BELL (Chair), Lamont-Doherty Earth Observatory, Palisades, New York  
JAMES E. BERNER, Alaska Native Tribal Health Consortium, Anchorage, Alaska  
DAVID BROMWICH, The Ohio State University, Byrd Polar Research Center,  
Columbus  
CALVIN ROBERT CLAUER, University of Michigan, Ann Arbor  
JODY W. DEMING, University of Washington, School of Oceanography, Seattle  
ANDREW G. FOUNTAIN, Portland State University, Oregon  
SVEN D. HAAKANSON, Alutiiq Museum, Kodiak, Alaska  
LAWRENCE HAMILTON, University of New Hampshire, Durham  
LARRY HINZMAN, International Arctic Research Center, Alaska  
STEPHANIE PFIRMAN, Barnard College, New York, New York  
DIANA HARRISON WALL, Colorado State University, Ft. Collins  
JAMES WHITE, University of Colorado, Department of Geological Sciences,  
Boulder

### ExOfficio:

JACKIE GREBMEIER, University of Tennessee, Knoxville  
MAHLON C. KENNICUTT II (U.S. Delegate to SCAR), Texas A&M University,  
College Station  
TERRY WILSON (Alternate U.S. Delegate to SCAR), Ohio State University,  
Columbus

### NRC Staff

CHRIS ELFRING, Director  
MARIA UHLE, Program Officer  
RACHAEL SHIFLETT, Senior Program Assistant  
ANDREAS SOHRE, Financial Associate

## Acknowledgments

This report has been reviewed in draft form by individuals chosen for their diverse perspectives and technical expertise, in accordance with procedures approved by the National Research Council's Report Review Committee. The purpose of this independent review is to provide candid and critical comments that will assist the institution in making its published report as sound as possible and to ensure that the report meets institutional standards for objectivity, evidence, and responsiveness to the study charge. The review comments and draft manuscript remain confidential to protect the integrity of the deliberative process. We wish to thank the following individuals for their review of this report:

- Charlie Bentley, University of Wisconsin
- Don Blankenship, University of Texas, Austin
- Joyce Jatko, Navy Installations Command (CNIC)
- Andrew Fountain, Portland State University
- John Priscu, Montana State University
- John Rummel, NASA Headquarters
- Sergey Bulat, Russian Academy of Sciences
- Martin Siegert, University of Edinburgh
- Lonnie Thompson, The Ohio State University
- Martyn Tranter, University of Bristol

Although the reviewers listed above have provided constructive comments and suggestions, they were not asked to endorse the report's conclusions or recommendations, nor did they see the final draft of the report before its release. The review of this report was overseen by Mary Albert, Cold Regions Research and Engineering Laboratory. Appointed by the National Research Council, she was responsible for making



certain that an independent examination of this report was carried out in accordance with institutional procedures and that all review comments were carefully considered. Responsibility for the final content of this report rests entirely with the authoring committee and the institution.

# Contents

SUMMARY	1
1 INTRODUCTION	11
The Discovery of Subglacial Lakes, 13	
SCAR and International Exploration of Subglacial Aquatic Environments, 23	
Determining the Suitability of Subglacial Aquatic Environments for Exploration, 26	
Antarctic Preservation Values, 28	
Purpose of this Report, 29	
2 GEOLOGICAL AND GEOPHYSICAL SETTING	32
Basin Settings: Rift and Non-Rift, 32	
Basement Rock Characteristics, 34	
Ice Sheet Description, 37	
Geographical Location of Antarctic Subglacial Lakes, 40	
Pre-Ice Sheet Lakes and Sediments, 43	
Age of Lakes and Water Residence Time, 43	
Lake Connectivity, 44	
Circulation and Stratification, 49	
Sediment Environment, 55	
Gases, 57	
Conclusions, 59	
3 SUBGLACIAL ENVIRONMENTS: BIOLOGICAL FEATURES	62
Introduction, 62	
Requirements for Life, 62	
Potential Impediments to Life in Subglacial Aquatic Environments, 64	
Source Populations, 68	

Evolution of Life in Subglacial Aquatic Environments, 70	
Current Evidence for Life in Subglacial Aquatic Environments, 73	
Biology—Conclusions, 78	
<b>4 DRILLING AND SAMPLING TECHNOLOGIES AND THE POTENTIAL FOR CONTAMINATION</b>	<b>81</b>
Technologies to Access Subglacial Aquatic Environments, 81	
Needs for Technology Developments, 86	
Potential for Chemical Contamination, 88	
Potential Sources of Biological Contamination, 93	
Other Potential Sources of Contamination—Particulates in the Fluid, 94	
Potential for Testing and Assessing Contamination: Experiences from Deep Biosphere Sampling, 96	
Potential for Testing and Assessing Contamination: Experiences from Interplanetary Research, 98	
What Levels of Cleanliness are Feasible When Accessing Subglacial Environments?, 100	
Biological Contaminant Detection, 100	
Conclusions, 101	
<b>5 ANTARCTIC GOVERNANCE AND IMPLICATIONS FOR EXPLORATION OF SUBGLACIAL AQUATIC ENVIRONMENTS</b>	<b>104</b>
Antarctic Treaty, 104	
Planetary Protection and the Outer Space Treaty, 105	
Management Goals for Good Stewardship, 110	
Conclusions, 112	
<b>6 FINDINGS AND RECOMMENDATIONS</b>	<b>114</b>
Toward Exploration of Subglacial Environments, 114	
Next Steps in Subglacial Exploration, 116	
Toward Establishing Levels of Cleanliness, 119	
Exploration Protocols, 122	
Research Needs, 124	
Guidelines for Stewardship, Management, and Project Review, 125	
<b>REFERENCES</b>	<b>129</b>
<b>APPENDIXES</b>	
A Statement of Task	143
B Biographical Sketches of Committee Members	145
C List of Acronyms	150

## Summary

Antarctica is renowned for its extreme cold; yet liquid water occurs at the base of the Antarctic ice sheet, several kilometers beneath the surface. This discovery was first made in the 1970s by researchers using airborne radio-echo sounding measurements. Using both airborne and surface radar, researchers have now identified more than 145 subglacial lakes (Figure S.1), the largest of which is Lake Vostok with a surface area of 14,000 km<sup>2</sup>, similar to that of Lake Ontario. In addition, radio-echo sounding data indicate that shallow, swamp-like features the size of several city blocks, as well as water-saturated layers of soils or broken rocks, may exist beneath the ice sheet, giving rise to a wide range of subglacial aquatic environments beyond just the large lakes. All of these subglacial aquatic environments form from meltwater that develops as a result of steady geothermal heat flux from the Earth, the melting point lowering caused by the weight of the overlying ice, and the insulation of the ice sheet. Recent evidence shows that many of the subglacial aquatic environments comprise vast watersheds connected by rivers and streams that flow beneath the ice sheet.

The presence of subglacial lakes on the frozen continent has captured the interest of people, both scientists and nonscientists alike. These lakes and their connected aquatic systems are among the last unexplored places on Earth. Moreover, they have been sealed from free exchange with the atmosphere for millions of years, making it possible for unique microbial communities to exist in these environments. Scientists are excited about the opportunity to observe microbial evolution; to learn about how hydrologic systems below ice sheets are connected, how they function, and how they impact the flow of Antarctic ice; and to discover if sediments in these lakes contain evidence about the climate of the Antarctic over many millions of years, perhaps even before the continent was covered with ice.

Although much can be learned about these environments from remote sensing and ice core data, many of the key questions about these systems require that samples of water, microbial communities, sediments, and underlying rock be obtained. As of early 2007, no one had yet drilled into a lake; thus, the next challenge in the exploration of subglacial aquatic environments is to determine the best way of drilling into, sampling, and monitoring these environments.

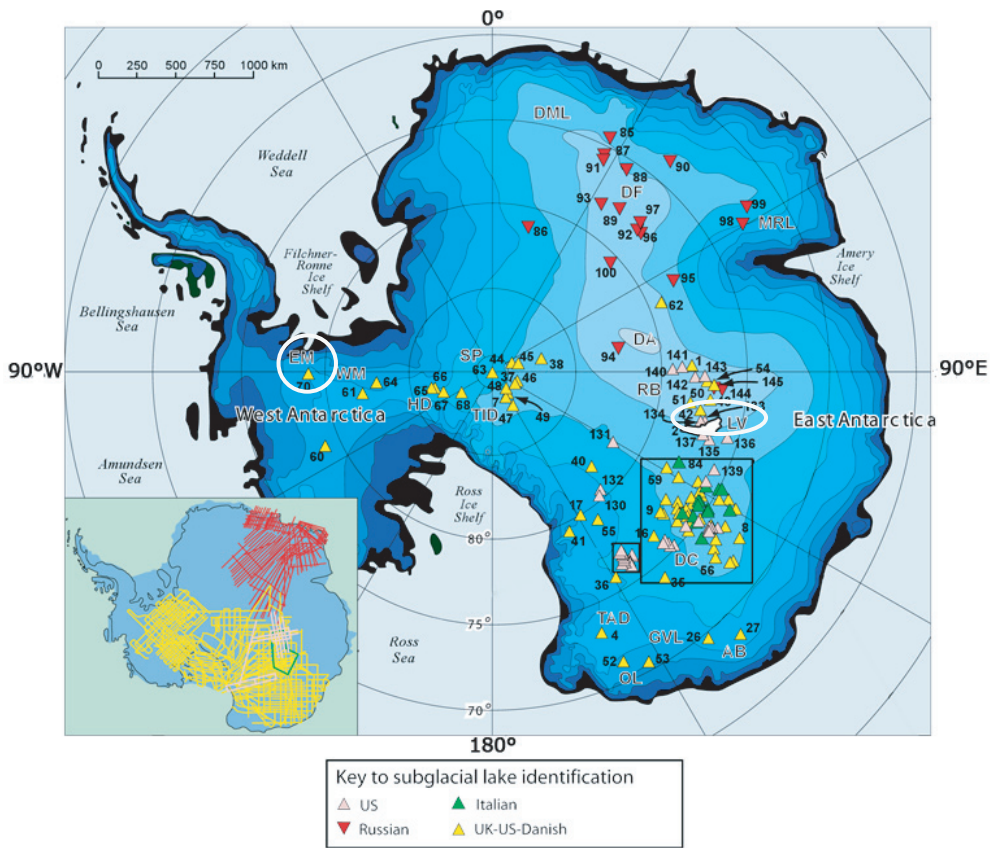

FIGURE S.1 Locations of 145 Antarctic Subglacial lakes discovered by scientists from several countries. Most of the lakes are small (less 20 km in length). Currently, Lake Vostok is the only Antarctic subglacial lake about which we have any depth information. A few larger lakes may be up to 1000 m deep. White circles show the locations of Lake Ellsworth (EM) and Lake Vostok (LV). Map inset shows distribution of radio-echo sounding flight lines. SOURCE: Modified from Siegert et al. (2005a). Reprinted with the permission of Cambridge University Press.

Currently, no clear protocols or standards for minimizing contamination have been established for subglacial aquatic environments, although general guidelines are provided in the Antarctic Treaty Protocol. Before sampling should proceed, specific protocols that ensure stewardship of the environment and the scientific integrity of the areas under study need to be developed, including sampling methods that minimize microbial and chemical contamination. It is critical to develop appropriate protocols now because planning for entry into these environments is already proceeding. Preparations for sampling Lake Vostok (Box 1.1 in Chapter 1) are well advanced; plans to explore subglacial Lake Ellsworth (Box 1.2 in Chapter 1) have been circulated through the international community; and two other subglacial aquatic environments are under consideration for exploration.

## EFFORTS TO GUIDE SUBGLACIAL LAKE EXPLORATION

The Scientific Committee on Antarctic Research (SCAR)<sup>1</sup> is the international body that initiates, develops, and coordinates scientific research in the Antarctic region. In response to growing scientific and public interest over the exploration of subglacial lakes, SCAR established the Subglacial Antarctic Lake Exploration (SALE) group, composed of scientists from SCAR member nations. The SCAR SALE group has provided international organizing and planning for the exploration of subglacial lake environments. The main objectives of the SCAR SALE program are to understand the formation and evolution of subglacial lake processes and environments; determine the origins, evolution, and maintenance of life in subglacial lake environments; and understand the limnology and paleoclimate history recorded in subglacial lake environments.

One of the key scientific questions posed in the SCAR SALE program concerns the origins, evolution, and maintenance of life in subglacial lakes. The SCAR SALE group speculated that life in subglacial lakes could be unique; thus any attempt to sample the water, the sediment, or the organisms directly should ensure that the subglacial aquatic environment is not contaminated, especially by carbon substrates that might perturb the aquatic ecosystem. The SCAR SALE group recommended an integrated science plan to ensure that one type of investigation does not accidentally adversely affect other investigations; that sampling regimes plan for the maximum interdisciplinary use of the samples; and that all information is shared to promote greater understanding. The SCAR SALE group continues to foster international coordination and collaboration; however, the group has not examined stewardship issues in depth.

## CHARGE TO THE COMMITTEE

The National Science Foundation (NSF) has requested guidance from the National Academies to suggest a set of environmental and scientific protection standards needed to responsibly explore the subglacial lake environments found under continental-scale ice sheets. In response, the National Research Council of the National Academies created the Committee on the Principles of Environmental and Scientific Stewardship for the Exploration and Study of Subglacial Environments. Specifically, the committee was asked to (see Appendix A for the Statement of Task):

- Define levels of “cleanliness” for equipment or devices entering subglacial aquatic environments;
- Develop a sound scientific basis for contamination standards recognizing that different stages of exploration may be subject to differing levels of environmental concern; and
- Recommend the next steps needed to define an overall exploration strategy.

The committee was also charged to consider existing technology with respect to contamination and to highlight potential needs for technological development; to identify additional scientific studies that are needed to reduce contamination; to assess

---

<sup>1</sup>SCAR is an interdisciplinary committee of the International Council for Science (ICSU). In addition to its primary scientific role, SCAR also provides objective and independent scientific advice to the Antarctic Treaty Consultative Meetings and other organizations on issues of science and conservation affecting the management of Antarctica and the Southern Ocean.

whether it is scientifically beneficial to proceed with exploration now versus later; and to identify potential targets among the many Antarctic subglacial aquatic environments. Early in its deliberations, the committee recognized that subglacial lakes are hydrologically connected to other subglacial aquatic environments including shallow, swamp-like features and thin films of water beneath the ice sheet within the same drainage basin and that the tasks assigned to the committee were applicable to other subglacial aquatic environments. The committee, therefore, considers all subglacial aquatic environments, and not just lakes *per se*, to be within its charge.

The issue of environmental stewardship for the exploration of subglacial aquatic environments is important to many stakeholders and interested parties, including those from the international community. This committee did not debate whether the current initiatives to explore subglacial lakes should continue, acknowledging that the scientific investigation of subglacial aquatic environments has previously been assessed internationally through the Antarctic Treaty Protocol and that exploration has been accepted as a legitimate activity. The committee recognized that the fundamental responsibility of all parties subject to the Antarctic Treaty is to maintain the best possible environmental stewardship for all activities, while appreciating, as does the Antarctic Treaty, that some impacts are acceptable in pursuit of scientific understanding and that these should be mitigated to the extent practicable.

The committee sought to develop the scientific rationale for setting standards in a manner credible to this wide range of interests. In managing any future activities it is assumed that parties will recognize, as did the committee, that limiting the science to a few sites, encouraging expert collaboration, organizing a stepwise approach, and using the cleanest available technology will all maximize the scientific outputs and minimize the impacts. The committee anticipates this rationale will provide guidance to balance the value of the scientific information to be gained against the potential for alteration of the sites being studied.

#### ANTARCTIC SUBGLACIAL AQUATIC ENVIRONMENTS: STEWARDSHIP AND MANAGEMENT

Although no lake has been sampled directly, Lake Vostok has been studied using remote sensing, chemical and microbiological analyses of lake water that has frozen to the bottom of the Antarctic ice sheet (accretion ice), and geochemical modeling (Figure S.2). Results of these analyses suggest that the upper waters in the lake have a low salinity and possibly extremely high concentration of gases such as oxygen. Lake Vostok has been isolated from the atmosphere for more than 15 million years (Christner et al. 2006); the water, which flows very slowly through the system, is estimated to reside in the lake on the order of tens of thousands of years.

There is some controversy in the peer-reviewed literature about whether there are microorganisms living in Antarctica's subglacial lakes. The controversy is due mainly to the fact that there are currently no samples of lake water, only accreted ice. Based on published reports, the number of microbial cells in the accreted ice of Lake Vostok may be as high as 10,000 or as low as a few recognizable cells per milliliter. The water may also contain low levels of nutrients necessary to support microbial communities; estimates of dissolved organic carbon (DOC) concentrations range from undetectable to 250  $\mu\text{mol L}^{-1}$ , the latter being well above concentrations in the open ocean (typically about 70  $\mu\text{mol L}^{-1}$ ).

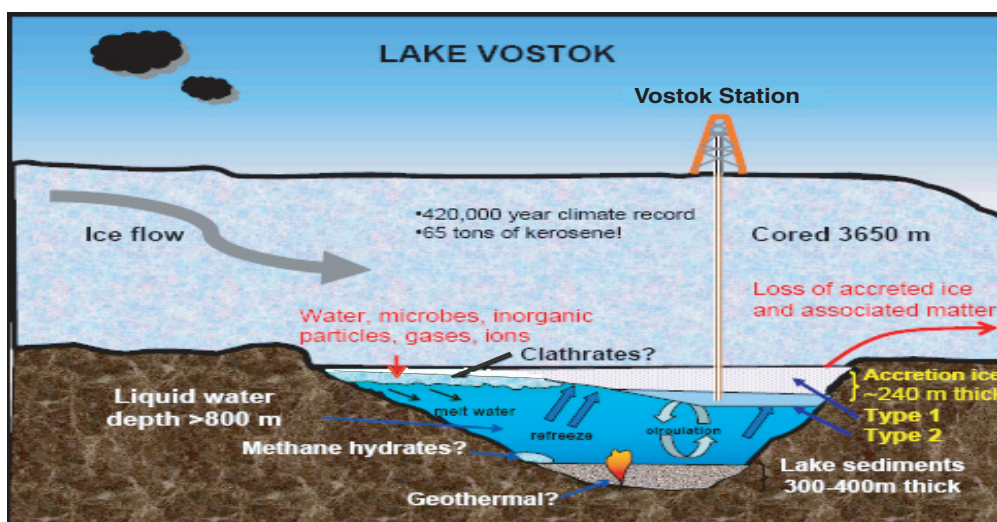

FIGURE S.2 Conceptual representation of processes likely occurring in Lake Vostok. Russian Antarctic Program drilling has penetrated through the ice sheet and into ice refrozen from lake water. Drilling of an additional 75 m is planned for the summer Antarctic season 2007/2008. No details regarding exact ice flow directions or areas of ice accretion are intended. Adapted from SCAR 2006, [http://salepo.tamu.edu/scar\\_sale/presentation](http://salepo.tamu.edu/scar_sale/presentation)). SOURCE: John C. Priscu, Montana State University.

Many types of microbes, including bacteria, yeasts, and fungal spores, are found in low abundances within the ice sheet above the lakes, and some of these microbes may still be viable as they enter the subglacial aquatic environment. As a result, despite the pressure and temperature regime of the subglacial environment, there is a possibility of microbial metabolism and growth. Rates of both growth and evolution are expected to be slow in these environments.

Methods and protocols to minimize contamination have been developed for other unique environments, however the extreme conditions under which the exploration of subglacial aquatic environments is conducted and the logistical constraints of keeping 4 km of drilling equipment sterile pose significant challenges. For example, it is not possible to follow protocols, such as those defined for planetary protection control associated with space exploration, that virtually eliminate microbes on instruments. It may be possible initially to control the quantity of microbes associated with drilling and sampling operations, but drilling through the ice sheet, which itself contains microbes at every level, will inevitably lead to a build up of microbes on equipment and in drilling fluids.

In light of potential adverse consequences on environmental and scientific stewardship, the committee favored a conservative research approach. Until there is definitive data concerning the absence of microbial populations, it should be assumed that microbial life exists. Our current understanding of the sub-ice habitats and their inhabitants is based entirely on indirect observations that range in scope from theoretical predic-



tions to direct chemical and microbiological analyses of accreted ice samples obtained from Lake Vostok. Consequently, the committee considers the identity and diversity of life, the nature of the electron donors and acceptors that support life (if life exists), and all other related ecological and biogeochemical properties as fundamental, but unanswered, questions.

Because it is possible that the concentration and type of microbial cells and organic nutrients may differ from sample to sample, the absence of viable microbes cannot be excluded until adequate sampling is done. It will be necessary to collect samples from several different locations not only within a lake but also within different lake systems. Even when freshly collected samples are available, it will be important to verify all measurements by analyses at several independent laboratories.

### CONNECTEDNESS OF SUBGLACIAL LAKES

The presence of vast connected watersheds beneath the ice sheet heightens the need for responsible environmental stewardship during the exploration of subglacial aquatic environments. If any single lake or other subglacial environment were to be altered by adding chemical contaminants or live organisms, the environments connected to the altered lake might also be changed. To minimize potential downstream contamination, responsible exploration requires a clear understanding of the subglacial hydrologic system before initial sampling is done.

### GUIDELINES FOR STEWARDSHIP, MANAGEMENT, AND PROJECT REVIEW

This report provides an initial framework for the environmental stewardship for the exploration of subglacial aquatic environments. The committee offers both a set of recommendations and a decision tree (Figure S.3 and Box S.1) as a framework and sequence for the environmental management decisions that need to be made at both the international and the national levels in accordance with the Antarctic Treaty Protocol. The framework has the necessary flexibility to be updated and evolve over time as new findings accumulate about drilling and exploration methods, and the biology, and the geology of subglacial regions.

As the science and exploration of subglacial environments grows beyond its infancy, the initial methodologies and protocols recommended in this report will need further development and regular revision. All aspects of management, stewardship, and project review and approval will continue to involve absolute requirements mandated by the Antarctic Treaty, government standards specific to particular parties, and scientific standards such as those recommended by SCAR. The recommendations of the committee are thus intended for integration into this multifaceted framework.

The committee's recommendations can be tracked in the diagram (Figure S.3). Recommendations 1 and 2 state the committee's conclusion that carefully managed scientific research on subglacial lakes should begin while preserving the environment for future potential discoveries through a suitably conservative approach. Working through SCAR, it will be important to develop criteria and research specifications that may be incorporated into management plans for subglacial aquatic environments (Recommendations 3, 4, 6, 7, 8, 9, 10, 12). Recommendation 12 suggests an initial protocol for the exploration of subglacial aquatic environments that can be used at the national and international levels.

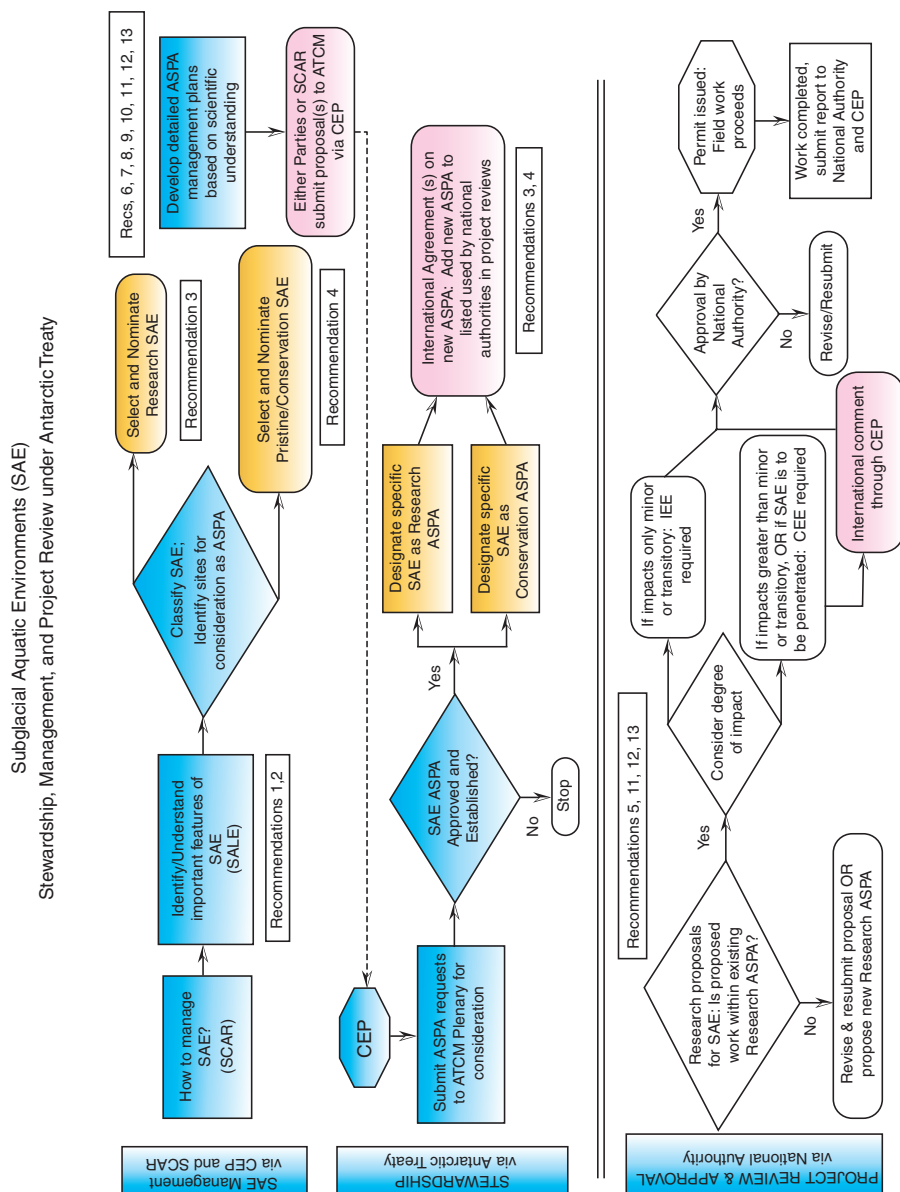

FIGURE S.3 Sequence and framework to address stewardship, management, and project review for subglacial aquatic environments. SOURCE: Dr. Margaret S. Race, Committee Member.

**BOX S.1****Recommendations for the Scientific and Environmental Stewardship for the Exploration of Subglacial Aquatic Environments****Recommendation 1**

Direct exploration of subglacial aquatic environments is required if we are to understand these unique systems. Exploration of subglacial aquatic environments should proceed and take a conservative approach to stewardship and management while encouraging field research.

**Recommendation 2**

Exploration protocols should assume that all subglacial aquatic environments contain or may support living organisms and are potentially linked components of a subglacial drainage basin.

**Recommendation 3**

As soon as adequate survey data have been gathered to provide a sound basis for description, all subglacial aquatic environments intended for research should be designated Antarctic Specially Protected Areas to ensure that all scientific activities are managed within an agreed international plan and are fully documented.

**Recommendation 4**

As soon as adequate survey data have been gathered to provide a sound basis for description, actions should be taken to designate certain exemplar pristine subglacial environments as Antarctic Specially Protected Areas for long-term conservation purposes.

**Recommendation 5**

Multinational projects should be encouraged in the study of subglacial aquatic environments, and all projects aiming to penetrate into a lake should be required to undertake a Comprehensive Environmental Evaluation.

**Recommendation 6**

The National Science Foundation should work in conjunction with the U.S. representatives to the Scientific Committee on Antarctic Research and to the Committee on Environmental Protection to involve all Antarctic Treaty nations in developing a consensus-based management plan for the exploration of subglacial aquatic environments. This plan should seek to develop scientific understanding and ensure that the environmental management of subglacial aquatic environments is held to the highest standards.

**Recommendation 7**

Drilling in conjunction with sampling procedures will inevitably introduce microorganisms into subglacial aquatic environments. The numbers of microbial cells contained in or on the volume of any material or instruments added to or placed in these environments should not exceed the minimum concentration of microbes in the basal glacial ice being passed through. Based on research to date, a concentration of  $10^2$  cells/ml should not be exceeded, until more data are available.

**Recommendation 8**

Drilling in conjunction with sampling procedures will inevitably introduce chemical contaminants into lakes and associated subglacial aquatic environments. Toxic and biodegradable materials should be avoided, as should the introduction of non-miscible substances. At a minimum, the concentrations of chemical contaminants should be documented and the total amount added to these aquatic environments should not be expected to change the measurable chemical properties of the environment. The amount added would be expected to have a minor and/or transitory impact on the environment.

**Recommendation 9**

Notwithstanding their compliance with Recommendations 7 and 8, investigators should continue to make every effort practicable to maintain the integrity of lake chemical and physical structure during exploration and sampling of water and sediments.

**Recommendation 10**

Allowances should be made for certain objects and materials to be placed into experimental subglacial aquatic environments for scientific purposes—for example, for monitoring or tracing dynamics. These additions should follow the microbiological constraints in Recommendation 7 and include discussion of environmental risk versus scientific benefit analysis as required by the Comprehensive Environmental Evaluation.

**Recommendation 11**

As the initial step to define an overall exploration strategy, the United States, together with other interested parties, should begin immediately to obtain remote sensing data to characterize a wide range of subglacial aquatic environments. As a second step, preliminary data and samples should be obtained from subglacial aquatic environments as soon as practicable to guide future environmental stewardship, scientific investigations, and technological developments.

**Recommendation 12**

Remote sensing of the potential aquatic environments beneath the Antarctic ice sheet is underway but is far from complete. The following actions should proceed in order to make a decision about which subglacial aquatic environments should be studied in the future:

- Continent-scale radio-echo sounding data should be assembled and subglacial aquatic environments identified;
- All regions where the basal melt-rate is likely high should be identified;
- Detailed radio-echo sounding of known lakes should be done;
- A hydrologic map of the subglacial drainage system for each catchment should be constructed;
- Potential target environments should be identified based on the subglacial drainage system.

Once potential research sites are identified, the likelihood of attaining scientific goals should be evaluated based on the representativeness for other lakes and settings, for accessibility, and for the constraints of logistics and cost. The committee recognizes that plans are underway to sample Lake Vostok, and in the longer term Lake Ellsworth and Lake Concordia. The data collected from these endeavors should be used to assess whether the levels of cleanliness suggested in Recommendation 7 are appropriate.

**Recommendation 13**

Research and development should be conducted on methods to reduce microbial contamination throughout the drilling, sampling, and monitoring processes, on methods to determine the background levels of microbes in glacial ice and lake water, and on development of miniaturized sampling and monitoring instruments to fit through the drilling hole. The following methods and technologies need to be improved or developed:

- A standard method to ensure cleanliness for drilling, sampling, and monitoring equipment that can be verified in the field;
- New ways of drilling through the ice sheet that include drilling fluids that would not be a substrate for microbial growth;
- Inert tracers in the drill fluids or fluids used to enter the lake to track the level and distribution of contaminants within the lake;
- Methods to determine baseline levels of microbes in the glacial ice and subglacial waters;
- Instrumentation scaled to fit through a bore hole, to measure chemistry and biology of these environments and transmit data back to the ice surface;
- Methods to provide clean access to the lake water for extended periods.

The committee recognizes that plans are underway to sample Lake Vostok, and in the longer term, Lake Ellsworth and Lake Concordia. The data collected from these endeavors should be used to better assess the requirements of future methodologies and technologies.

Exploration will continue to be subject to formal peer review through the Antarctic Treaty protocols (notably the Comprehensive Environmental Evaluation process), as soon as adequate survey data have been gathered to provide a sound basis for description, and to include comment by SCAR where appropriate. Stewardship for the future is best addressed by establishing a dynamic multinational approach and specific scientific archive that preserves and quantifies pertinent information associated with current scientific research, nationally and internationally (Recommendations 5, 11, 12, 13). Data archiving should include detailed information about drilling components, such as the microbial content of drilling fluids and any material components that may influence future research. The establishment of a microbial archive may become an important new initiative as surface and core microbial populations are sequenced and where possible, identified.

### CONCLUSION

The exploration of subglacial aquatic environments is in its initial stages, with fundamental questions remaining to be answered about these unique environments. Much debate and speculation have occurred based on the limited data available; no definitive answers will be forthcoming until these environments are sampled directly. The existence of these environments on the Antarctic continent makes them a part of the common heritage of all humankind. Accordingly, the management of subglacial aquatic environments requires responsible environmental stewardship while allowing field research in accordance with the Antarctic Treaty. Although this study is being produced by a U.S. scientific advisory body and the National Science Foundation requested the study to guide scientific programs originating in the United States, the committee hopes that its multinational makeup will be recognized and that the recommendations in this report will serve as a basis for broad international discussion about environmental stewardship for the exploration of subglacial aquatic environments.

## 1

## Introduction

The Antarctic continent has always been a place of surprises. In the eighteenth century, Captain James Cook expected to find a land of forests and pastures ripe for colonization; instead he discovered a vast, frozen, and seemingly useless continent that turned out to be one of the most difficult places on Earth to explore. Far from being useless, Antarctica has proven to play a critical role in many aspects of the Earth system as well as being an important platform for exploring the universe and a place of unique ecosystems. Given this history, perhaps it is not surprising that our expectations about the ice sheet sitting firmly on its underlying rock also have proven to be wrong.

From geophysical surveys, we now know that beneath the Antarctic ice sheet, water has accumulated over millennia forming watery subglacial environments ranging in size and form from Lake Vostok, a large water body similar in surface area to Lake Ontario, to shallow frozen swamp-like features the size of several city blocks. The discovery of subglacial aquatic environments has opened an entirely new area of science in a short period of time. We continue to make discoveries that constantly change our understanding of these environments. Our speculation that Lake Vostok was a unique feature has been changed by our discovery of more than 145 of these “subglacial aquatic environments.” These environments are first beginning to be characterized with remote sensing. Because they have never been sampled, very little is known about the physicochemical and biological processes within them. Lakes and other aquatic habitats now appear to be common and widespread beneath the ice sheet, and recent evidence shows that many of the subglacial aquatic environments comprise vast watersheds connected by rivers and streams that flow beneath the ice sheet.

These environments may have formed in response to a complex interplay of tectonics, topography, climate, and ice sheet flow over millions of years. They may have been sealed from free exchange with the atmosphere for millions of years and are analogous to the icy domains of Mars and Europa. Evidence from studies of the overlying ice indicates that microbial life may exist in these subglacial aquatic environments, although this remains a subject of controversy (Chapter 3). The region of highest density of these environments surrounds what is likely to have been one of the nucleation points for the East Antarctic ice sheet; the

lakes potentially contain sediments within their lake beds that may provide a record of major changes in the Antarctic ice sheet.

On the basis of the limited data we have so far, however, there seem to be several exciting scientific discoveries to be made from the study of these unique systems, especially the potential for unique microbial communities, a general understanding of the physiochemical processes of this extreme environment, and a history of environmental conditions from the sediment record. The discovery of subglacial aquatic environments, especially lakes, and the intriguing questions posed about these extreme environments have caught the attention of the public.

There is great value in setting the exploration of these environments in motion. From a scientific perspective, they may hold critical information needed to answer many questions about microbiological life, evolution, and adaptations; Antarctic and global climate over the past 65 million years; ice sheet dynamics; and evolution of subglacial aquatic environments and their associated hydrological and biogeochemical processes. Scientific interest in the subglacial hydrology of ice sheets has never been higher, because we need to learn as much as possible about how the subglacial water systems operate beneath ice sheets. The question of whether ice sheets can have a large dynamic response to changes at their margins (e.g., the breakup of ice shelves) partly involves the question of whether or not fast flow processes will be activated by changes in subglacial conditions. Thus, there are conceivable links to the important question of sea level rise. It is important for us to acquire this information in the next 5 to 10 years—not several decades from now.

During the Lake Vostok investigation (Box 1.1), data will be gathered that may help determine whether microbial life is present or absent from this environment. Chemical analyses of water samples will help settle speculative discussions about partition coefficients, which will improve geochemical modeling of these environments. The exploration plans for Lake Ellsworth (Box 1.2) call for a concentrated radio-echo sounding (RES) campaign followed by physicochemical and biological measurements and water and sediment sample recovery. With results of both of these investigations, we will only begin to develop an initial understanding of these environments, but these first samples will provide all-important evidence about how conservative we should be in moving forward. The data and lessons learned from these endeavors should be used to guide future environmental stewardship, scientific investigations, and technological developments.

The pursuit of scientific knowledge, however, needs to be balanced against environmental stewardship and cleanliness. Responsible stewardship during the exploration of subglacial aquatic environments requires that investigators proceed in a manner that minimizes the possible damage to these remarkable habitats and protects their value for future generations, not only in terms of their scientific value but also in terms of conserving and protecting a pristine, unique environment. This is particularly important because it now appears that these environments are hydrologically and potentially biologically connected and that activities at one site may affect other sites within the system.

No lake has yet been entered, thus no lake has been directly altered, chemically or biologically, by scientific study. It is to minimize the possible damage to these remarkable habitats from scientific investigations and protect their value for future generations that this National Research Council (NRC) study has been undertaken.

## THE DISCOVERY OF SUBGLACIAL LAKES

The continent of Antarctica is formed from a fragment of the Gondwana supercontinent, which included the continental masses of Africa, South America, Australia, Antarctica, and India. This supercontinent began to break apart in Early Cretaceous time (around 130 million years), and full isolation of Antarctica from other Gondwana fragments, and the associated possibility of circum-Antarctic ocean circulation, was achieved by 30 million years (Early Oligocene). Although there is evidence for alpine glaciation in Antarctica from Cretaceous time, it seems that a large ice sheet did not come into existence until around 35 million years (Anderson 1999). Since its formation the ice sheet has not entirely disappeared, although its eastern and western parts have experienced substantial fluctuations in volume.

The earliest attempts to measure ice depth in Antarctica used seismic sounding from the surface of the ice sheet where the reflection of shock waves generated by explosives was measured. Admiral Byrd's expedition to the Antarctic in 1939-1941 conducted trials of such a system, but the Norwegian-British-Swedish expedition in 1951-1952 pioneered the scientific use of this technique in the Antarctic. Although the technique proved cumbersome and slow, it was the best technique available at the time and was used during the International Geophysical Year (IGY) in 1957-1968 by several countries to provide important data about the underlying topography. The IGY data provided many interesting insights into the subglacial structures in the interior of the Antarctic, but the technique was too unwieldy to be extended across the whole continent.

The recognition that radio waves at very high frequencies could penetrate ice but were reflected by rock changed this approach and led to the development of Antarctic airborne radio-echo sounding by the Scott Polar Research Institute in the 1960s. Use of this technique across the Antarctic ice sheet provided, for the first time, the possibility of mapping the whole of the underlying continental rock (Robin 1972). The principal intention was to enable glaciologists to calculate more accurately the total mass of the ice sheet by measuring its thickness; however, the data collected provided valuable information to a wide range of scientists with many interests. By 1980, RES had been collected from more than 400,000 km of flight track, covering approximately 50 percent of the  $13.5 \times 10^6 \text{ km}^2$  Antarctic ice sheet. This coverage, however, was concentrated in only few areas, and despite continued survey work there are still many areas of the Antarctic continent for which no RES data exist (Figure 1.1). In some areas of the continent, flight lines are so widely spaced that subglacial features cannot be adequately mapped.

Compilation of all available data by the Scientific Committee on Antarctic Research (SCAR), however, resulted in the publication of the first detailed sub-ice topographic map (Lythe et al. 2001), which was critical in the developing search for subglacial water.

The possibility of the existence of subglacial water was first identified by Robin and others in 1968. They noted that in places the RES signal changed from one characteristic of an ice-rock interface to one indicative of an ice-water interface, which suggested that there could be water trapped between the bedrock and the bottom of the ice sheet. The first subglacial lake reported was located beneath Sovetskaya Station; water was also indicated under Vostok Station (Robin et al. 1970).



**BOX 1.1****Exploration of Subglacial Lake Vostok: Brief History and Future Plans**

Since 1990, the Russian Antarctic Expedition Program has drilled more than 3600 m of ice with additional support from the French and U.S. Antarctic programs between 1993 and 1998. The present borehole, 5G-1, was started in 1992 from a deviation along the previous borehole (5G) at depths of 2232-2246 m. By 1993 the coring had reached 2755 m in borehole 5G-1. After a one-year hiatus, drilling reached a depth of 3100 m in September 1995. Drilling continued during the 1995–1996 field season and was intended to continue through the 1996 winter to reach 25 m above the surface of the subglacial lake beneath Vostok (at ~3,650 m depth in accordance with the guidelines recommended by SCAR during the Lake Vostok Workshop, Cambridge 1995). However, when the station closed for the 1996 winter, drilling had reached 3350 m depth. A seismic survey was undertaken during the 1995–1996 field season in an area about 2 km<sup>2</sup> around the borehole. A depth of 3623 m was reached in hole 5G-1 in 1998. After an eight-year hiatus, drilling resumed in 2005-2006, reaching a depth of 3650 m.

At present, the bottom of hole 5G-1 is less than 100 m above the surface of Lake Vostok and the Russian Antarctic Program plans to continue drilling and eventually sample the waters of Lake Vostok. The next step proposed is to drill an additional 75 m to obtain new scientific data on the origin, properties, and structure of the ice near the “ice cover-subglacial lake” boundary. The proposed method to access Lake Vostok will exploit the physical peculiarities of the lake-ice sheet system. The ice sheet basically floats on the lake, and the pressure at the “ice-water” boundary corresponds to the weight of the overlying ice sheet. During drilling, the pressure exerted by the drilling fluids within the borehole compensates the pressure of the overlying ice and keeps the hole open. By decreasing the quantity of drilling fluids, the water pressure in the lake will be greater than that of the drilling fluids. When the drill reaches the lake, the drilling fluids will be forced up the borehole by lake water.

The borehole fluids comprise mainly aviation fuel (TS-1) and Freon (CFC-141b). These drilling fluids will not dissolve in water and will be displaced by the water rising in the borehole. Also, a sterile drilling fluid will be introduced into the lowermost 200 m of the hole, approximately 100 m above the lake surface, which will act as a plug between the top and clean bottom sections of the borehole. The density of this fluid is intermediate between the lake water and aviation drilling fluids.

It is planned that during the last stage of penetration, the drill will be extracted from the hole immediately after reaching the water surface. Lake water will rise in the borehole and freeze. Later, this newly frozen ice will be drilled to recover samples of the lake water. The newly formed ice remaining below the sampled lake ice will form a plug and thereby prevent a possible connection between the drilling fluids and the lake water. Thus, the proposed method will allow the sampling of lake water without the drill and sampling instruments entering the lake.

SOURCE: Robin Bell, Lamont-Doherty Earth Observatory of Columbia University.

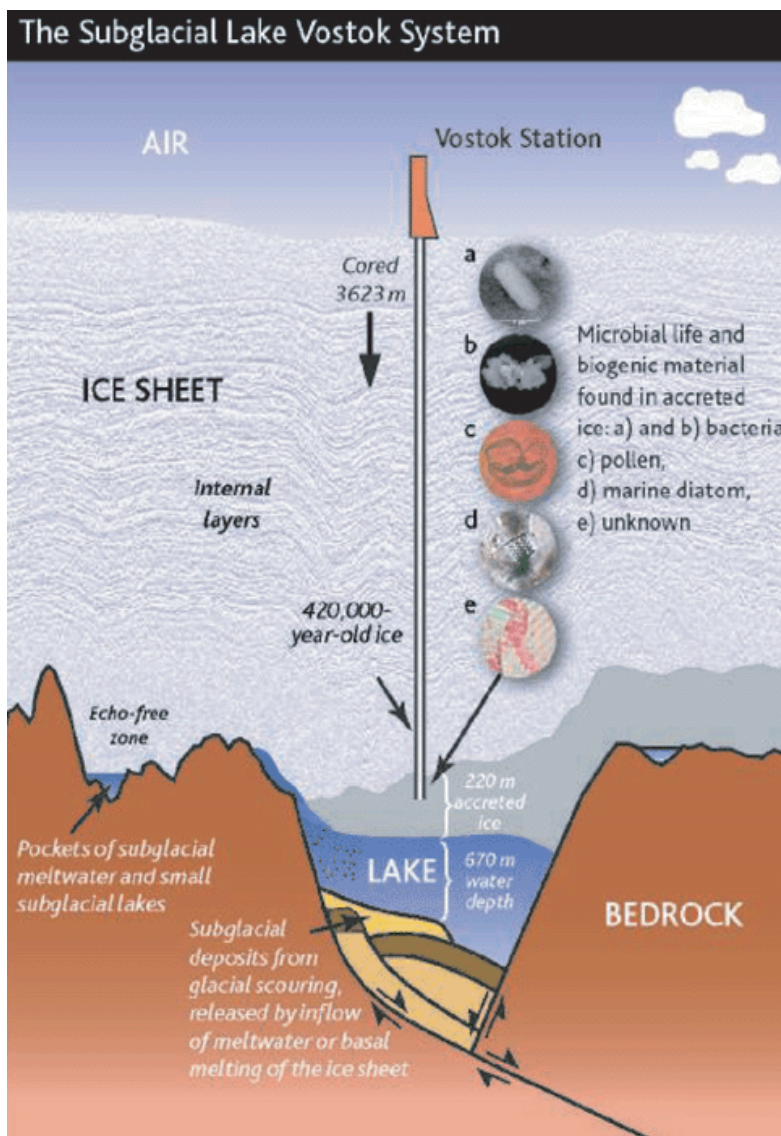

**BOX 1.2****An Eight-Year Plan for the Exploration of Subglacial Lake Ellsworth**

The comprehensive geophysical survey of Lake Ellsworth is planned to occur in two seasons during IPY 2007-2009 and will include RES, seismic surveying, and a variety of surface measurements. Discussion of the feasibility of a U.K.-led subglacial lake exploration program began at the British Antarctic Survey in April 2004. Currently, a consortium of more than 30 scientists from seven countries and 14 institutions is planning to access Lake Ellsworth using hot-water drilling. The project will involve a geophysical survey; instrument development; hot-water drilling and fieldwork; biological and geochemical analysis of water samples; and sedimentological analysis of lake floor deposits.

**Phase 1—Geophysical Exploration (3 years):** The size and shape of Lake Ellsworth, flow of the ice sheet over the lake, and subglacial topography surrounding the lake will be measured. Objectives include measuring water depth, sediment thickness across the lake floor, and dimensions of the lake's drainage basin.

**Phase 2—Instrument and Logistic Development (2 years):** Equipment will be assembled and logistics for physical exploration will be planned. Probes will be built and tested to measure the physical and chemical properties of the lake's water and to sample lake water and sediment. Objectives include developing a means of communication between the probe and the ice surface; building and testing a hot-water drill; and acquiring and testing a sediment corer capable of extracting a 2- to 3-m core from the floor of Lake Ellsworth to recover climate records.

**Phase 3—Fieldwork (1 year):** A hot-water drill will be used to bore a 30-cm-wide hole to gain access to the lake from the ice sheet surface. It is anticipated that the borehole will be held open for 24-36 hours. Just before the drill enters the lake, the water generated during drilling will be removed to ensure that the borehole water does not enter the lake. Once the lake is reached and lake water floods into the borehole, a probe capable of measuring the lake's biology, chemistry, and physical environment will be deployed through the water column to the lake floor and subsequently retrieved. A sediment corer will be used to retrieve a 2- to 3-m sediment core.

**Phase 4—Data Analysis and Interpretation (2 years):** Data, sediment, and samples acquired by the probe will be analyzed to comprehend the physical and chemical structure of the lake; ascertain the form, level, and distribution of microbial life in the water column and water-sediment interface; undertake geochemical analysis; and if a sediment core is acquired, analyze sedimentary records.

SOURCE: Michael Studinger, Lamont-Doherty Earth Observatory of Columbia University.

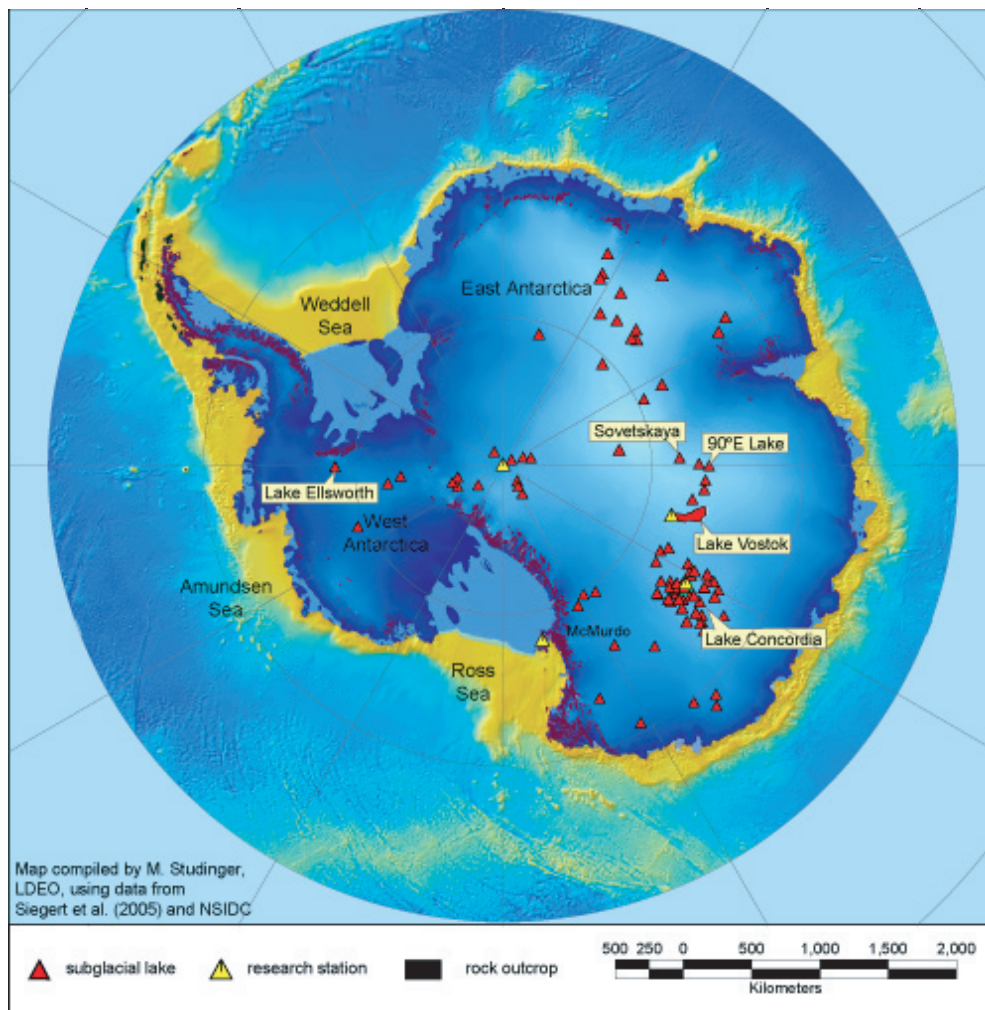

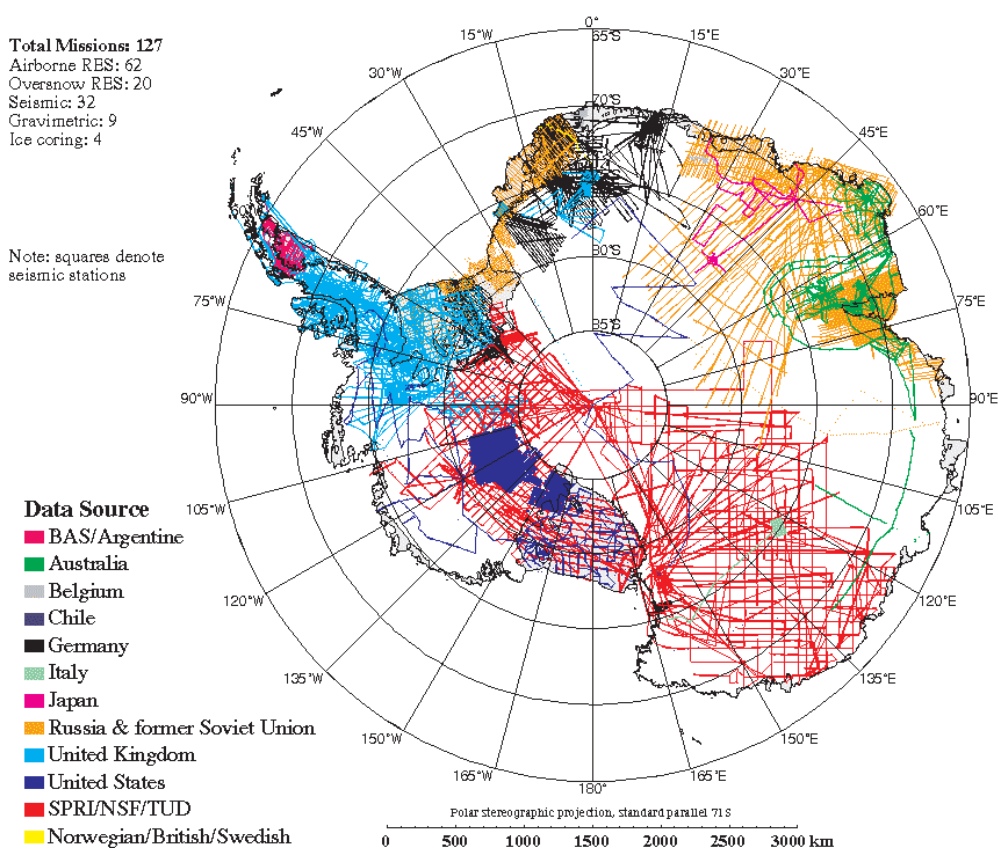

FIGURE 1.1 Present airborne radio-echo sounding over Antarctica collected by various countries. SOURCE: BEDMAP Consortium.

In 1974-1975, an airborne radio-echo survey of ice depths over central East Antarctica near the Vostok Subglacial Highlands led to the discovery of a subglacial lake with an area of about 10,000 km<sup>2</sup>, lying underneath almost 4 km of ice and apparently close to Vostok Station. Subsequent surveys indicated a large flat area in the bedrock, lying in what appeared to be a large valley, with a water surface above it. The image was seen on the RES records as a distinctive, mirror-like reflection (Figure 1.2). It is now known that some of the lake surface is covered with accretion ice, formed from lake water, that is attached to the bottom of the glacial ice (Figure 1.2). The Russian drilling operation, which has recovered ~3600 m of ice, has entered this accretion ice but has not yet penetrated the waters of Lake Vostok itself.

The advent of satellites with radar altimeter sensors able to measure the height of the ice sheet surface to within a few centimeters has provided a complementary approach to locating such lakes, because the flat lake surface is apparently reflected in the ice surface topography kilometers above it. In 1993, altimetric data from satellite

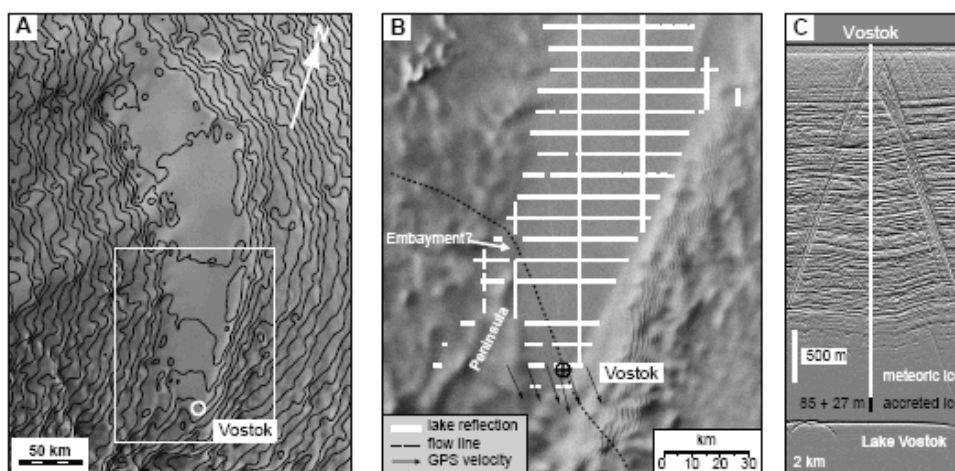

FIGURE 1.2 (A) Composite RADARSAT synthetic aperture image of the ice above Lake Vostok (data available from the National Snow and Ice Data Center, <http://nsidc.org/>). Contour lines are ice surface elevation (10-m interval) from airborne laser altimetry (Studinger et al. 2003a). The lake shows as the flat featureless region in the center of the image. White box marks map area shown in (B), the southern shoreline of Lake Vostok. Solid white lines mark airborne radar echo profiles with lake reflections (Studinger et al. 2003a). The flow line through the Vostok ice core (black dashed line) has been derived by tracking internal structures in the ice over the lake and the gradient of the ice surface over grounded ice (Bell et al., 2002). (C) Airborne ice-penetrating radar profile through the Vostok 5G core site. 85 m of accretion ice was drilled at 5G in 1998, and an additional 27 m was recovered during the 2005-2006 austral summer (V. Lukin, pers. comm.). SOURCE: Christner et al. (2006).

measurements provided independent evidence of the areal extent of the Vostok lake, thus confirming it to be the largest known subglacial lake. Using RES and satellite altimetry together, the location and extent of this subglacial lake, now named Lake Vostok, was described by Kapitsa et al. (1996).

The surface area of Lake Vostok is 14,000 km<sup>2</sup> (comparable to Lake Ontario), but early estimates of its volume have proved to be conservative. Recent geophysical interpretations (Studinger et al. 2004) yield an estimated volume of 5400 km<sup>3</sup>, more than three times the volume of Lake Ontario, and an average water depth of 360 m (Figure 1.3). Kapitsa et al. (1996) estimated that the residence time of the water in the lake is likely to be of the order of tens of thousands of years and that the mean age of water in the lake, since deposition as surface snow, is about 1 million years.

The snow and glacial ice overlying Lake Vostok contain microorganisms such as bacteria, yeasts, fungi, and microalgae (Abyzov 1993; Abyzov et al. 1998), although questions remain about the introduction of microbial contaminants during the sampling required to generate such records. Microbes may be concentrated in the liquid-water veins between ice crystals and under such conditions could metabolize at temperatures well below the freezing point (Price and Sowers 2004; Price 2007).

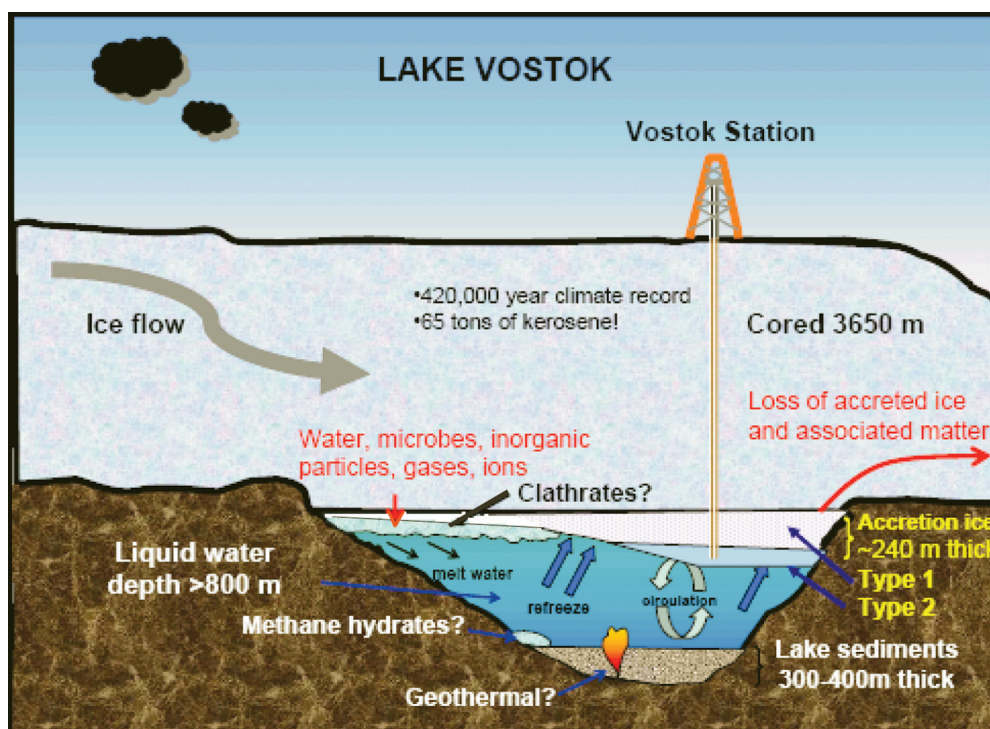

FIGURE 1.3 Conceptual representation of potential processes occurring in Lake Vostok. No details regarding exact ice flow directions or areas of ice accretion are intended. Adapted from SCAR 2006 ([http://salepo.tamu.edu/scar\\_sale/presentation](http://salepo.tamu.edu/scar_sale/presentation)). SOURCE: John C. Priscu, Montana State University

More recently, drilling at Vostok Station recovered 3623 m of ice core but halted in 1998, when the drill was 120 m above Lake Vostok. As summarized by Christner et al. (2006), the last 84 m of the ice core has a chemistry and crystallography distinctly different from the overlying glacial ice. This 204 m of ice, called accretion ice, is Lake Vostok water frozen onto the bottom of the glacial ice. The accretion ice contains measurable dissolved organic carbon as well as low but detectable numbers of prokaryotic (bacterial) cells. A portion of the assemblage of microbes is capable of metabolic activity, as was demonstrated when ice metabolized added  $^{14}\text{C}$ -organic compounds (Karl et al. 1999). Molecular identification of microbes within the accretion ice show close similarity to Proteobacteria, Firmicutes, Actinobacteria, and Bacteroidetes.

Microorganisms are continually deposited from the atmosphere onto the surface of the ice sheet (Vincent 1988) and some may survive the lengthy transport to subglacial aquatic environments, thereby providing a potential source of microbial life to these environments. Spore-forming bacteria (including many Gram-positive species) are likely to be especially resistant to the severe conditions imposed by long-range transport in the atmosphere and during residence within and at the surface of the Antarctic ice sheet.

Subglacial aquatic environments have been seen by many as an analogue of ice-bound worlds elsewhere in our solar system (e.g., Europa) and a potential testing ground for how we might investigate them (Priscu et al. 1999).

Not surprisingly the discovery of Lake Vostok has stimulated others to search the RES database and satellite data to determine if other subglacial lakes exist. More than 145 lakes have now been identified by characteristically strong, mirror-like, and very flat RES reflections (Figure 1.2C) (Siegert et al. 2005a). Most of the subglacial aquatic environments are located in the ice sheet interior, and 33 percent are within 100 km of the ice crest. Mean ice thickness above the lakes is about 3000 m. About 75 percent of lakes have radio-echo lengths of <10 km, and only 5 percent are >30 km although all are smaller than Lake Vostok. Some near-flat surface regions that usually occur over lakes have also been observed where it appears that no lakes exist. Such features may be caused by water-saturated basal sediments rather than subglacial lakes (Carter et al. 2007). In areas where the RES coverage is very dense, it is possible that all but the smallest subglacial aquatic environments have been identified. However, the distribution of flight lines (Figure 1.1) is not uniform over the continent and more subglacial aquatic environments may exist in regions for which no data currently exist. Siegert et al. (2005a) used a minimum length limit of 500 m to identify and locate the 145 lakes listed in the inventory. In the future, it may be possible to improve the discrimination in the signal analysis to lower the minimum length to 100 m.

Until recently, each subglacial lake was considered to be an isolated unit. Continuing analysis has revealed that several of the lakes are clearly connected to each other; Wingham et al. (2006) used satellite altimeter data to show a 2- to 3-m change in the surface height of the ice sheet in locations above subglacial lakes, which is suggestive of water draining subglacially from one lake into another (see recent data for many lakes in Fricker et al. 2007). Although there might be other explanations, the evidence is strong enough that subglacial lakes should be considered part of a discontinuous hydrological system rather than isolated entities. This raises a caution to researchers: if one aquatic environment is contaminated during drilling or sampling, there is a possibility of the contamination spreading to other subglacial aquatic environments. An attempt to map the likely subglacial water paths and identify sub-ice catchments is under way (Siegert et al. 2006).

This changing appreciation of the extent and importance of subglacial hydrology has fundamental implications for many areas of science but seems especially critical for those investigations that intend to drill to the bottom of the ice sheet because these activities may potentially affect subglacial aquatic environments that are located down the hydrologic gradient (Carter et al. 2007). Figure 1.4 shows the location of all the holes that have already been drilled to bedrock or nearly through the ice sheet. Many of these sites are located within suspected drainage basins of identified subglacial aquatic environments.

Liquid water is able to accumulate at the bottom of the ice sheets, including the Greenland ice sheet, because of the presence of geothermal heat, the lowering of the freezing temperature of water from the pressure of the overlying ice, and the insulation provided by the ice sheet (Siegert et al. 2003). This was illustrated dramatically when “pink-colored” water unexpectedly entered the bottom 45 m of the NGRIP (North Greenland Ice Core Project) borehole in Greenland and froze (Anderson et al. 2004). The color was caused by minerals such as sulfides and iron compounds.



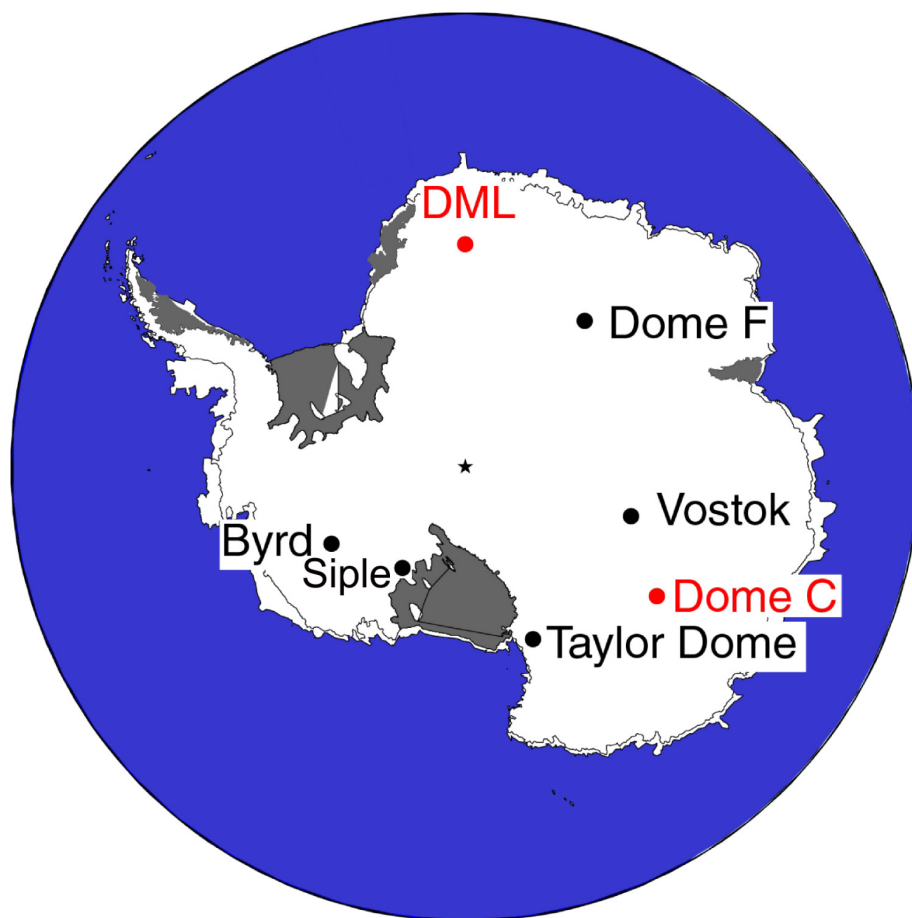

FIGURE 1.4 Location of holes that have been drilled to bedrock or nearly through the ice sheet on the Antarctic continent. SOURCE: H. Miller, Committee Member.

The region with the highest spatial density of subglacial water bodies surrounds what is likely to have been one of the nucleation points for the East Antarctic ice sheet. Subglacial aquatic environments located in these regions may contain sediments that accumulated prior to ice sheet formation and may potentially contain paleo-records of major shifts in climate.

Streams—that is, moving water beneath the Antarctic ice sheet—are inferred but have not actually been measured. Streams could form in meltwater channels that occur irregularly at the bottom of the ice sheet or could flow within layers of rocks or fractured bedrock that resemble the hyporheic flow paths beneath the beds of most rivers and streams (e.g., Wondzell 2006).

Investigation of lakes and other aquatic environments buried under kilometers of ice has attracted a great deal of scientific interest over the last decade. Although much

can be learned about these systems from remote sensing, many of the key questions require direct sampling. To sample the water, the microbial communities, the sediments, and the underlying rock under the lakes requires drilling through the ice and the insertion of sampling and monitoring equipment into the lake. All of these processes pose both technical problems and problems of potential contamination with microbes from the surface.

### SCAR AND INTERNATIONAL EXPLORATION OF SUBGLACIAL AQUATIC ENVIRONMENTS

In just over a decade, subglacial lake environments have begun to emerge as the newest frontier in Antarctic science and exploration. Many nations are moving ahead with their own investigations (Boxes 1.1 and 1.2), and there has been much international debate over how to proceed in the effort to understand these unique environments. In response, the international scientific community participated in two workshops (1998<sup>1</sup> and 1999<sup>2</sup>) to establish the rationale for the study and exploration of subglacial lake environments, assess technological needs for these endeavors and develop a 10-year time line for study and exploration.

During the Cambridge workshop (1999), the scope of investigation was expanded beyond just Lake Vostok to include all subglacial lakes under thick ice sheets. A set of guiding principles was established for future activities. These principles clearly stated that the program must be international and interdisciplinary in nature; noncontaminating technologies and minimum disturbance must be fundamental considerations in program design and execution; the ultimate goal should be lake entry and sample return to ensure the greatest scientific benefit; and the best opportunity to attain interdisciplinary scientific goals is by study of larger lakes, therefore Lake Vostok must be the ultimate target of study.

Following a recommendation from the Cambridge workshop (1999), the Scientific Committee on Antarctic Research constituted a Subglacial Antarctic Lake Exploration Group of Specialists (SALEGOS) in 2000, composed of scientists from SCAR member nations and charged the group to begin a process of discussion and collaborative planning. This group met six times over the next four years and made great progress in developing a science and technology plan for an ambitious program of interdisciplinary exploration and study.

A final recommendation of the SALEGOS was that Subglacial Antarctic Lake Exploration (SALE) progress to a SCAR Scientific Research Program. A SALE proposal and an implementation plan were prepared and submitted to SCAR. In October 2004, SALE was named one of five SCAR major science programs. SCAR SALE<sup>3</sup> met for the first time in April 2005, and a second meeting was held in April 2006. The SCAR SALE terms of reference are listed in Box 1.3. To focus certain activities, SCAR SALE has developed a data management policy and established Subcommittees on Data, Technology, and Education, and on Outreach and Communication.

---

<sup>1</sup>Subglacial Lakes: A Curiosity or a Focus for Interdisciplinary Research, Washington, D.C., sponsored by the U.S. National Science Foundation.

<sup>2</sup>Subglacial Lake Exploration: Workshop Report and Recommendations, Cambridge, U.K., sponsored by the Scientific Committee on Antarctic Research and the Council of Managers of Antarctic Programs.

<sup>3</sup>SCAR SALE activities are chronicled on its web site: [http://salepo.tamu.edu/scar\\_sale](http://salepo.tamu.edu/scar_sale).

---

**BOX 1.3**  
**SALE Terms of Reference**

SALE is charged with the following:

- Oversee and guide the development and execution of the Scientific Research Plan's (SRP) activities, including changes in course as indicated by events and progress.
  - Encourage and facilitate communication and collaboration between scientists and technologists worldwide involved in the exploration of subglacial lake environments while seeking support for the program through national and international mechanisms.
  - Advise the international community through SCAR on scientific and technology issues relevant to subglacial lake exploration, including environmental protocols, procedures, concerns, and safeguards.
  - Promote collaboration, data access, and data sharing to facilitate and expedite the data syntheses needed to develop and revise the science and technology agenda for the exploration of subglacial lake environments.
  - Summarize and report the results of these efforts to the scientific and wider community on an ongoing basis, including regular reporting on the use of SCAR funds.
  - Encourage adherence to the agreed guiding principles of exploration and research on subglacial lake environments, especially environmental stewardship.
  - Be an advocate for exploration of subglacial lake environments in all venues, including national committees, scientific communities, and the public, and establish scientific liaisons and logistics cooperation with other Antarctic entities and activities as appropriate.
  - Respond to requests from SCAR for expert advice in a timely manner, including convening of expert groups when needed (i.e., review of Comprehensive Environmental Evaluations).
  - Ensure that SRP activities are justified and supportive of the group's terms of reference.
  - Interact and coordinate activities with other SCAR SRPs.
  - Provide a centralized focus for outreach efforts, including promotional materials, a web site, an available speaker and topic list, interactive tools for educating the public, a bibliography (including press releases and articles in the lay print and visual media), meeting reports, regular press releases, and contact information for the media.
- 

The main scientific goals of SCAR SALE are to understand the formation and evolution of subglacial lake processes and environments; determine the origins, evolution, and maintenance of life in subglacial lake environments; and understand the limnology and paleoclimate history recorded in subglacial lake environments. While there are numerous interesting scientific questions posed in the SCAR SALE program, one of the most important is concerned with the origins, evolution, and maintenance of life in subglacial aquatic environments. The SCAR SALE group speculated that if the residence time of the water in any subglacial aquatic environment is very long, and if the lake is ultra-oligotrophic as well as dark and under pressure, then the life it contains could be unique, possibly providing hitherto unknown species with unusual biochemical or physiological capabilities. Thus any attempt to sample the water, the sediment, or the organisms directly should ensure that the subglacial aquatic environment is not contaminated, especially by carbon substrates that might allow the aquatic system to fundamentally change.

Echoing the guiding principles from the Cambridge workshop (1999), the SCAR SALE group recommended that an integrated science plan for the future be developed to ensure that one type of investigation does not accidentally impact other investigations adversely; that sampling regimes plan for the maximum interdisciplinary use of the samples; and that the sharing of all information promotes greater understanding. SCAR continues to serve as the international focal point of activities to facilitate cooperation in the exploration and study of subglacial lake environments in Antarctica, advising the international community on issues related to exploration, research, data management, and other matters.

In addition, members of the U.S. scientific community have formed the U.S. Subglacial Antarctic Lake Environments (SALE) Program, which is a long-term exploration and research program formed by a group of scientists and technologists who share the goal of a comprehensive and environmentally safe investigation of subglacial environments with a special focus on subglacial lakes ([http://salepo.tamu.edu/us\\_sale/saleexcom](http://salepo.tamu.edu/us_sale/saleexcom)). The U.S. SALE Program seeks to support and facilitate opportunities for U.S. participation in the international collaborative teams that will be addressing common scientific and technological objectives. The U.S. SALE Program includes a series of science, technology, education, and communications or public relations committees. The committees operate relatively autonomously, responding to requests for advice and, organizing workshops or meeting as appropriate to set the SALE agenda in each focus area. U.S. SALE seeks to liaise with other SALE committees and organizations to develop cross-disciplinary connections and promote venues to consider common issues.

The exploration of subglacial aquatic environments will also be a focus for the International Polar Year (IPY),<sup>4</sup> which began on March 1, 2007. Various parties participating in SALE projects have joined together as the SALE Unified Team for Exploration and Discovery (UNITED). Closely coupled with the SCAR SALE, these programs will join together to promote and advance common scientific, technological, and logistical issues. The ambitious interdisciplinary objectives of SALE can be realized only by multiple exploration programs that will investigate exemplars of the diverse subglacial environments over the next decade or more. The IPY provides an opportunity for an intensive period of initial exploration that will advance scientific discoveries to a new level that could not otherwise be achieved by a single nation or program. Each program is an independently managed campaign with specific scientific objectives, logistical requirements, and management structure that will contribute to, and accrue added value from, a common international research agenda. Synergy is provided by the pooling of resources where appropriate, the sharing of experiences and expertise, the coordination of logistics and technological developments, and a shared vision (more details are provided at [http://salepo.tamu.edu/sale\\_united](http://salepo.tamu.edu/sale_united)).

---

<sup>4</sup>IPY 2007-2008 will be an intense, internationally coordinated campaign of research that will initiate a new era in polar science. IPY 2007-2008 will include research in both polar regions and recognize the strong links these regions have with the rest of the globe. It will involve a wide range of research disciplines, including the social sciences, but the emphasis will be interdisciplinary in its approach and truly international in participation. It aims to educate and involve the public and to help train the next generation of engineers, scientists, and leaders.

### DETERMINING THE SUITABILITY OF SUBGLACIAL AQUATIC ENVIRONMENTS FOR EXPLORATION

Recommendations from a SALEGOS workshop (SALEGOS 2001) identified six questions to guide selection of suitable subglacial lake environments for exploration:

1. Does the lake provide the greatest likelihood for attaining the scientific goals?
2. Can the lake be characterized in a meaningful way—for example, size, postulated structure?
3. Is the lake representative of other lakes and settings?
4. Is the geological or glaciological setting understood?
5. Is the lake accessible (near existing infrastructure)?
6. Is the program feasible within cost and logistical constraints?

Siegert (2002) applied the first five questions to the inventory of known subglacial lakes to identify which were the most suitable subglacial aquatic environments for exploration. While the current inventory has greatly expanded since 2002, the overall approach to assess which lakes are most suitable for exploration is still valid. As Siegert (2002) points out, all subglacial aquatic environments have the potential to achieve the scientific goals of SCAR SALE, discussed earlier, in that these lakes are ice covered, and contain water and most likely sediments. The question then becomes, Which of these lakes are most suitable to attain these goals? At present, Lake Vostok is the only subglacial lake that has been characterized beyond just a broad RES survey. A concentrated RES campaign (Bell et al. 2002), coupled with seismic, interferometric synthetic aperture radar (SAR) (Siegert et al. 2001) and ice coring (Petit et al. 1999) studies, has revealed more information about this lake than any other environment. However, to fully characterize the lake floor morphology and lake sediments requires time-consuming, ground-based seismic sounding. The size of Lake Vostok makes this endeavor much more challenging and time intensive. Siegert (2002) suggested that a detailed survey of a smaller lake may provide more information in a more timely and economical manner.

In addition to size considerations, topographic setting will strongly influence how easily these environments can be characterized. Environments with relatively flat topography are more easily characterized than basins with complex topography and steep sides (Siegert 2002). Although small basins with relatively flat topography are potentially better candidates for exploration, the trade-off is that basins with steep sides are likely to be deeper and may contain longer, better-preserved sediment records.

As the inventory of subglacial aquatic environments has grown, several classification schemes have been proposed (Chapter 2). Regardless of which classification system is employed, it is clear that several different types of environments exist in different glaciological and topographic settings and that no one lake is representative of all other environments. In fact, Lake Vostok is unique in that it is the largest known subglacial lake and it occupies an entire subglacial valley (Siegert 2002). Although the physical constraints imposed by the ice sheet (Chapter 2) may cause many of the physical processes within all subglacial aquatic environments (Chapter 2) to be similar, the underlying geology and geothermal setting may influence the biogeochemical processes of these environments. At present, it is unknown whether the biogeochemical processes in different types of environments from different settings are similar. This

lack of data is a challenge for determining which environments are representative. At present, we can only choose representative environments based on physiography or geophysical characteristics.

For most subglacial aquatic environments, the glaciological setting has been rudimentarily described through RES surveys. However, there are very few detailed geological data from beneath the Antarctic ice sheet, and this lack of data inhibits our ability to characterize the geological setting in which these environments are contained and to understand the geological history of these environments. In addition the glacial history of East Antarctica is markedly different from the history of West Antarctica. The paleoenvironmental records obtained from similar types of aquatic environments from central West Antarctica or Dome C will be relevant only to their respective region of the continent (Siegert 2002). This geographical divide is another consideration in choosing exemplar environments.

Accessibility of potential sites may be the deciding factor in choosing between equally suitable environments for exploration. Logistical needs for exploration are not trivial and the proximity of sites to existing support, such as research stations or runways, is a compelling argument in selecting a site. For example, the southern end of Lake Vostok is located directly beneath Vostok Station, but the northern end is approximately 200 km from the station (Siegert 2002). Aquatic environments in the Dome C area are near where the European Project for Ice Coring in Antarctica (EPICA) ice core was recovered, and environments in the South Pole region are close to South Pole Station. Lake Ellsworth is located along a crevasse-free path to the Patriot Hills, where a blue ice runway exists enabling personnel and supplies to be directly airlifted from Punta Arenas, Chile.

After weighing all the criteria, is there one subglacial aquatic environment that is best suited for exploration? Siegert (2002) concluded that no one single environment could be studied to achieve all of the scientific objectives set forth by SCAR SALE. In terms of assessing the existence of endemic ancient life, Lake Vostok provided the most viable location because it is substantially older and deeper. However, Lake Vostok is not necessarily representative of other subglacial aquatic environments in terms of physiography and its size makes a complete characterization by ground-based methods extremely challenging. These drawbacks suggest that other lakes, such as a small lake from Dome C, may be viable candidates (Siegert 2002).

The varied glacial history of East and West Antarctica requires that more than one lake be explored to establish robust paleoenvironmental records. In addition, Siegert (2002) suggested that records from several sites would place the glacial history in a spatial context and therefore improve the details of ice sheet changes. Siegert (2002) advocated that a subglacial lake exploration strategy need not require that all scientific objectives be accomplished through sampling of a single lake. Different sites may be more appropriate to answer specific questions. For example, if the search for life is the sole objective, then any subglacial aquatic environment may be selected. If the goal is to establish paleoenvironmental records, then it would be wise to sample multiple sites in areas that are sensitive to such changes.

Since Siegert (2002) undertook this assessment, more environments have been discovered and compelling evidence for a subglacial drainage system has developed (e.g., Wingham et al. 2006; Fricker et al. 2007). Consequently, the suitability of specific subglacial aquatic environments for exploration must depend on the position of the potential site within the subglacial hydrological system. At present, our knowl-

edge of this system is rudimentary (Siegert et al. 2007) and more detailed analysis is needed to appreciate the implications of this system for any exploration strategy that is developed.

## ANTARCTIC PRESERVATION VALUES

### Stewardship for Science, Aesthetics, and Wilderness

The Antarctic is more highly protected, in terms of environmental legislation, than any other continent. Since the Antarctic Treaty was signed in 1959 there has been a growing international accord on providing protection for its species and ecosystems; on ensuring peace in the region; and on utilizing the unique features of the Antarctic to advance science, often by international collaboration.

The Antarctic constitutes the world's largest remaining wilderness area, a place of great beauty and challenge, the least polluted place on Earth and one that many nations have already committed themselves to protect. Such stewardship underlies the Antarctic Treaty, and although the nations that signed the treaty constitute only 25 percent of the United Nations, they more than represent 70 percent of the global population, making such a commitment globally significant.

The lack of industry and an indigenous human population makes Antarctica unique among all the continents. The international system of governance through the Antarctic Treaty System (NRC 1986) works by consensus, providing perhaps the best global forum in which to agree and implement the concept of stewardship.

The idea of stewardship is not new but has only recently come to the fore in the Antarctic as a more coherent framework for conservation and environmental management has been implemented through the Protocol on Environmental Protection to the Antarctic Treaty. Indeed, recognition of the Earth as a connected system and the development of Earth system science have given added impetus to the need for conservation and sustainable management on a global scale.

Maintaining the present environmental state of Antarctica has assumed increasing importance as its relevance to science has become clear. The Antarctic ice sheets are a critical part of the Earth's hydrological balance, as well as the most important heat sink. The continent provides an opportunity to measure baseline global pollution levels, and the measurements of greenhouse gases at the South Pole have been a key feature of research into global climate change. As was made clear in an earlier NRC study (NRC 1993), the twin objectives of environmental stewardship and scientific research are intimately connected through a feedback loop, with increasing knowledge allowing better regulation of research. This use of scientific results to formulate policy and regulation is at the heart of the present philosophy of Antarctic governance.

Recognition of the values that needed to be protected was clearly spelled out in the Antarctic Treaty protocol, which in turn had been derived from the many earlier resolutions agreed to by the Consultative Parties. There had been an early recognition of the importance of protecting examples of a wide range of habitats and of providing special protection to species thought to be under threat. At the habitat level, most of the Antarctic Specially Protected Areas have been established to protect the vegetation or the fauna. However, in at least two cases the importance of protecting the unique microbial communities of a site has been the basis of designation. In both of these cases the sites were associated with geothermal activity, and the regulations for access

take account of the need to avoid the inadvertent introduction of new microbes during a visit by requiring participants to wear “clean-room” clothing. The designation of the McMurdo Dry Valleys as an Antarctic Specially Managed Area (ASMA No. 2: <http://www.cep.aq/apa/asma/sites/ASMA2.html>) similarly recognized the importance of preserving microbial habitats and biota, and one of the stated objectives of its management plan is to minimize the introduction of alien species, including microbes.

Life in a subglacial lake under 4 km of ice is expected to be microbial. While it is not yet certain either how ancient the flora is or what connectivity may exist between lakes, it is clear that good stewardship not only would require extreme care in sampling such environments but also would require that examples of the major types of lakes, once established, should be afforded the same level of legal protection already provided for sites and habitats at the surface.

### PURPOSE OF THIS REPORT

SCAR has to date led the effort to organize international planning for the exploration of subglacial aquatic environments and will continue to foster international coordination and collaboration. SCAR, however, has not done a critical analysis of stewardship issues. In particular, the issues of how to minimize contamination of subglacial lake environments during study and provide responsible stewardship of these unique and possibly connected environments would benefit from an external and objective review.

Potential contamination that might occur during the exploration and study of subglacial lake environments includes introductions of naturally occurring environmental microorganisms, anthropogenic microorganisms, and chemicals derived from exploration tools and equipment. There are two key issues: how to collect the best possible samples for scientific study while minimizing contamination of the sites and ensuring preservation for future scientific inquiry, and how to ensure wise stewardship of these unique environments, including strict observance of environmental protection responsibilities under domestic and international laws and treaties. These two issues are likely to have different requirements. Because research objectives include detecting the presence of life at very low concentrations, the collection of samples will require stringent protocols. In addition, public perception and general stewardship issues will be important for acquiring the resources and permissions needed to undertake these studies.

Before proceeding with further exploration of these unique subglacial lakes, clearer guidance is needed on how to conduct the work in an environmentally and scientifically responsible manner. To meet this need, the National Science Foundation (NSF) has requested guidance from the National Academies to address the environmental and scientific protection standards necessary to responsibly explore the subglacial lake environments found under continental-scale ice sheets. In response, the National Research Council of the National Academies created the Committee on the Principles of Environmental and Scientific Stewardship for the Exploration and Study of Subglacial Environments.

Specifically, the committee was asked to do the following:

1. Define levels of “cleanliness” for equipment or devices entering subglacial lake environments necessary to ensure that the environments are subject to minimal,



reversible, or acceptable change caused by the introduction of either naturally occurring Earth surface materials and life forms or anthropogenic substances.

Develop a sound scientific basis for contamination standards considering a number of steps. These steps include delineation of the most likely sources of contamination, description of methods that might be used to reduce these introductions (e.g., physical cleaning, sterilization, coating of surfaces with antifouling materials), and discussion of methodologies that might be used to demonstrate that the acceptable levels of “cleanliness” have been achieved. This analysis should recognize that different stages of exploration may be subject to differing levels of environmental concern and that some activities have been reviewed and approved for use elsewhere. The committee was asked to consider the protocols developed for planetary protection over the past 40 years by National Aeronautics and Space Administration (NASA) and assess their utility, applicability, transferability, and adaptability to subglacial lake environment exploration and research.

2. Recommend next steps needed to define an overall exploration strategy. The committee was asked to use existing planning documents and lessons learned from previous activities that have penetrated and potentially contaminated subglacial environments as a starting point, to consider:
  - The merits and disadvantages of existing technology with respect to contamination, highlighting additional technological development that is needed;
  - Procedures and additional scientific studies to ensure that the best available environmentally and scientifically sound practices are adhered to and contamination risks are reduced to acceptable levels during the entry and sampling of subglacial lake environments;
  - Costs and benefits in terms of scientific outcomes of exploring now versus later; and
  - Potential targets among the many Antarctic lakes.

The committee appreciates the presentations and supplementary materials provided by the scientific community and members of the SCAR SALE group. The NRC committee’s findings and recommendations are based on its analysis of the materials and briefings received and the committee’s expert judgment. Committee members were drawn from four countries and have expertise in environmental protection and stewardship, Antarctic Treaty policy, planetary protection, astrobiology, microbial ecology in extreme environments, genomics, glaciology, subglacial processes, geochemistry, polar contamination prevention, and drilling and sampling technologies.

This report addresses the environmental and scientific protection standards needed to responsibly explore the subglacial aquatic environments. The motivations for this study are to ensure wise stewardship of these unique environments, including strict observance of environmental protection responsibilities under domestic and international laws and treaties, and to determine how to collect the best possible samples for scientific study while minimizing site contamination and ensuring preservation for future scientific inquiry. The issue of environmental stewardship for the exploration of subglacial aquatic environments is important to many stakeholders and interested parties, including those from the international community. The committee sought to develop the scientific rationale for setting standards in a manner credible to this wide range of stakeholders and interested parties. The summary, introduction, and conclusion chapters address the issues in a general manner intended for a wide-ranging

audience; whereas Chapters 2 through 5 provide technical details intended for the scientific community.

In preparing this report, the committee recognized that the responsibility of all parties subject to the Antarctic Treaty is to maintain good environmental stewardship for all activities, while appreciating that some impacts are acceptable in pursuit of scientific understanding and that these should be mitigated as far as possible. The committee acknowledged that the scientific investigation of subglacial aquatic environments has previously been vetted internationally through the Antarctic Treaty Protocol and exploration has been accepted as a legitimate activity. The charge to the committee was concerned with how to undertake such an activity while maximizing the overall protection of this particular environmental resource. In managing any future activities it is assumed that parties will recognize, as did the committee that limiting the science to a few sites, maximizing the expertise, organizing a stepwise approach, and using the cleanest available technology will all maximize the scientific outputs and minimize the impacts. The committee hopes this rationale will provide important guidance for developing, testing, and verifying sensor deployment and sampling protocols to balance the value of the scientific information to be gained against the potential for alteration and/or contamination of the sites being studied.

## 2

## Geological and Geophysical Setting

Despite the cold surface, large areas of the bed of the Antarctic ice sheet are at the ice pressure melting temperature and actively melting through the combined influence of the insulating cover of glacial ice and the flow of geothermal heat into the base of the ice sheet. In regions where the subglacial rate of meltwater production exceeds the rate of removal by freezing to the base, some kind of drainage system must form to transfer water from regions of net production to regions where freeze-on dominates or to the ice sheet periphery. The presence of water at the base of the ice sheet has been confirmed by deep drilling to the bed and by radar imaging of subglacial lakes (Siegert et al. 2005a). New evidence indicates that some of these lakes are interconnected (Wingham et al. 2006; Fricker et al. 2007). The geometry, storage, and transport processes of this subglacial drainage system are incompletely understood, but it seems reasonable to expect that, in most cases, the lakes are not isolated entities but should be viewed as components of an extensive subglacial aquatic environment.

### **BASIN SETTINGS: RIFT AND NON-RIFT**

#### **Lake Classifications**

At least three classification schemes have emerged from recent studies of the Antarctic subglacial lakes, based largely on interpretations of geophysical images. Two of these classifications focus on the description of morphology and physiography, whereas the other scheme distinguishes different types of environments by focusing on the characteristics of the radio-echo sounding data. One of the first schemes was developed by Dowdeswell and Siegert (2003) based on the glaciological and/or topographic setting and the physiography of the subglacial lakes. This classification resulted in three categories of subglacial aquatic environments: (1) lakes within subglacial basins located in the ice sheet interior; (2) lakes perched on the sides of subglacial mountains; and (3) lakes located in areas of enhanced ice flow.

The majority of the lakes are located in subglacial basins within roughly 100 km of ice divides in the ice sheet interior. These basins are typically separated by mountain ranges and their topography can either be relatively subdued, often near the center of subglacial basins, or relatively steep, occupying significant subglacial depressions, often near subglacial basin margins (Dowdeswell and Siegert 2003). Deep subglacial lakes are likely to develop in areas where the topography is subdued. Lake Vostok is the only known lake that occupies a large section of a subglacial trough. Perched lakes are located primarily in the interior of the ice sheet on the flanks of subglacial mountain ranges. These perched lakes are frequently small, measuring less than 10 km in length. Many other lakes occur in areas where the ice flow is enhanced, hundreds of kilometers from the ice sheet crest, such as the fast-flowing Byrd Glacier, which drains a very large interior drainage basin into the Ross Ice Shelf. These lakes are expected to be similar in size and depth to the small and most likely shallow subglacial aquatic environments found in the major subglacial basins in the ice sheet interior (Siegert 2002).

Another of these schemes, based on description of surface morphology and shape, has identified three categories of lakes: basin, relief, and trench (Tabacco et al. 2006). Basin lakes occur at the bottom of large depressions, usually in association with areas of considerable relief in the bedrock. They have irregular shapes, but no preferred elongation directions. This group of lakes is therefore thought of as resulting from glacial scouring. Relief lakes occur in subglacial mountainous regions, at fairly high bedrock elevation. They, therefore, have thinner ice cover than the basin lakes. Trench lakes, as their name implies, have an elongated shape controlled by the nature of the depressions in which they are found. These depressions are long and narrow and typically have steep cross-sectional profiles that may be fault bounded.

Lake Vostok and others in the Dome C region may belong to the trench lakes category. Studinger et al. (2003) have modeled Lake Vostok as the product of overthrust faulting followed by a small amount of extensional faulting during reactivation with the opposite-to-original sense of motion (Figure 2.1). However, this interpretation remains controversial because the majority of Antarctic subglacial lakes are developed on basement rocks that became part of the stable craton in the Precambrian, leaving few opportunities for more recent faulting to create basins in which subglacial lakes can form.

The third classification scheme of subglacial lakes is based on the characteristics of the return signals from each one of these features using ice-penetrating radar as displayed on radargrams. With this approach, three categories of lakes have been identified: great lakes, dim lakes, and fuzzy lakes (e.g., Blankenship et al. 2006).

Great lakes are ones that yield well-defined radar images with flat tops and flat bottoms. Their radar echo is bright, and they all seem to be at least 500 m across. Blankenship et al. (2006) estimate that there are about 30 great lakes among the subset of the 130 lakes that were surveyed systematically using ~51,000 line km of radar data.

Dim lakes are characterized by less clear tops and bottoms on radargrams compared to great lakes. Dim lakes may have started as “great lakes” but have since frozen over. Alternatively, their images may be artifacts of the ice temperature correction applied in the calculation being wrong. The evolution from great lake to dim lake may be caused by flow regime change (e.g., changes in the temperature of the ice).

Fuzzy lakes are distinguished by having hydrologically “flat” radar images that are, however, full of reflections that do not appear to be water. Terms such as mushy swamps or wetlands have been used in descriptions of these features.

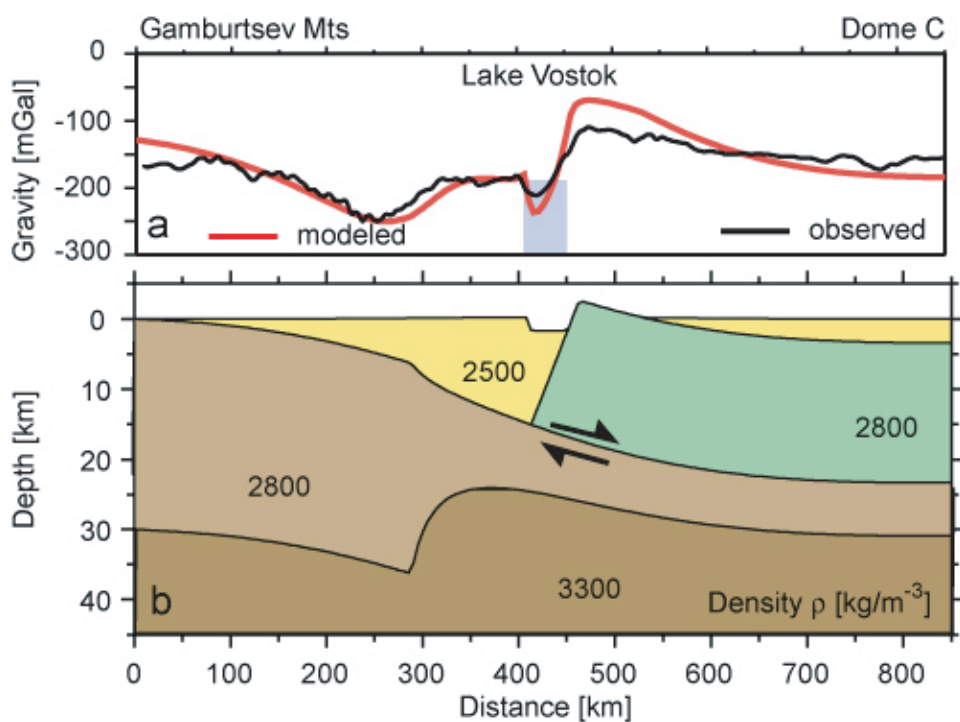

FIGURE 2.1 Diagram from Studinger et al. (2003b) illustrating that Lake Vostok has been modeled as a 50-km-wide tectonic basin developed in a continental collision zone between the Gamburtsev Subglacial Mountains and the Dome C region. SOURCE: Reprinted from *Earth and Planetary Science Letters*, 216 (4): Studinger et al. (2003b) with permission from Elsevier.

### Other Subglacial Environments

Little is known about the ice-bedrock interface in large regions of Antarctica because of the poor airborne radar survey coverage and the lack of drilling to bedrock. In areas that have been surveyed, there is also the potential complication of surface roughness scattering the radar signal and thus preventing accurate bedrock surface mapping and characterization of the nature of the ice-bedrock interface. Enough is known, however, for the glaciology community to have accepted that in addition to well-defined subglacial lakes, there is a substantial capacity for liquid-water storage in water-saturated subglacial sediments (e.g., Siegert and Bamber 2000).

### BASEMENT ROCK CHARACTERISTICS

An understanding of the bedrock geology beneath the ice sheets is important to help determine how and when subglacial aquatic environments formed and whether these

environments are connected. Like much information about the Antarctic continent, the basement rocks of the East Antarctic Shield are still poorly understood compared to other continents. This lack of knowledge is a result of the fact that 98 percent of the area is ice covered, and the 2 percent of it that is exposed, generally in coastal regions, is challenging to access. For this reason, current understanding of the basement geology of East Antarctica is constrained largely by seismic data, modeling of gravity and aeromagnetic data, and extrapolations of coastal rock exposures and deformational structures. However, recent examination of the assembly of the East Antarctic Craton suggests that Neoproterozoic to Cambrian rocks (900 million to 543 million years ago), similar to those in the Pinjarra Orogen of Western Australia (Figure 2.2), may exist in the vicinity of some subglacial lakes, including Lake Vostok (Fitzsimons 2003).

A similar age for the basement rocks beneath the ice sheet was indicated from geochemical ( $^{87}\text{Sr}/^{86}\text{Sr}$  versus  $^{143}\text{Nd}/^{144}\text{Nd}$ ) and mineralogical characterization as well as dating (neodymium model age) of a millimeter-size bedrock inclusion recovered from the accreted ice section of the Lake Vostok core (Delmonte et al. 2004). This study made the assumption that the inclusion samarium to neodymium ratio is representative of the basement in spite of its small size. In agreement with the neodymium model ages, new uranium-thorium-lead ion microprobe determinations on detrital zircon and monazite, also from the Lake Vostok core, have yielded ages of between 1800 million and 600 million years (Rodionov et al. 2006). This range is similar to that observed at the surface in the Prince Charles Mountains, Prydz Bay, and Wilkes Land.

The fact that “young” ages in the range of 1800 million to 600 million years are being recognized from materials recovered in the Vostok core, suggests that faults and sutures exist that are juxtaposing basement rocks of a variety of ages. This is relevant to the study of subglacial aquatic environments because if the interior of Antarctica has fractured rocks as suggested by Figure 2.2, then it is not only likely but inevitable that these subglacial aquatic environments constitute a connected hydrologic system.

Further evidence for a potentially connected hydrologic system comes from the hydraulic conductivities<sup>1</sup> of bedrock beneath the ice sheet. The hydraulic conductivities of unfractured, igneous, and metamorphic rocks comparable to those observed in East Antarctic coastal exposures are low ( $3 \times 10^{-14}$  to  $2 \times 10^{-10}$   $\text{m s}^{-1}$ ), which means that water does not flow through these rocks readily. However, if the interior of the East Antarctic Craton in the vicinity of Ridge B are dominated by fractured crystalline rocks, as suggested by models 2 and 3 of Fitzsimmons (2003) in Figure 2.2, then the local hydraulic conductivity is likely to be several orders of magnitude greater ( $8 \times 10^{-9}$  to  $3 \times 10^{-4}$   $\text{m s}^{-1}$ ) than that of solid rocks (Domenico and Schwartz 1998).

From a number of studies, it is evident that the East Antarctic basement rocks are Precambrian in age (3800 million to 543 million years ago), but definitive ages of large sections of the basement rocks remain scarce. Palinspastic reconstructions<sup>1</sup> show that the East Antarctic basement rocks were formerly the nucleus around which the southern continents were amalgamated to form the supercontinent Gondwanaland. Therefore, this part of the continent is generally regarded as a tectonically stable cratonic region stabilized by ~800 million years when the supercontinent Rodinia fragmented. The Gamburtzev Mountains, which lie beneath the ice just west of Lake Vostok, have an estimated relief of 3500-4000 m. This relief, which is anomalously high for a cratonic

---

<sup>1</sup>A paleogeographic or paleotectonic map showing restoration of the features to their original geographic positions, before thrusting or folding of the crustal rocks.

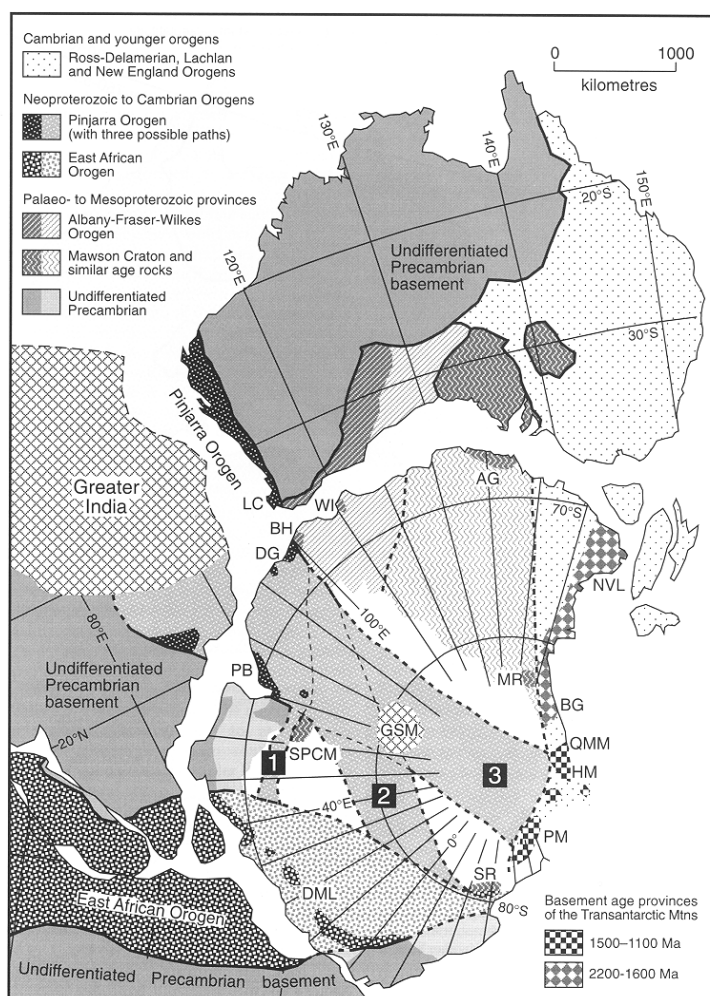

FIGURE 2.2 The bedrock geology beneath most of interior East Antarctica is not well known, and three possible interpretations for the architectural makeup of the crust beneath the East Antarctic lakes have been proposed and are labeled 1, 2 and 3. Interpretations 1 and 2 place Paleoproterozoic (2500 million to 1600 million years ago) to Mesoproterozoic (1600 million to 1900 million years ago) rocks of the Mawson Craton beneath the Lake Vostok region. Interpretation 3 on the other hand places Neoproterozoic to Cambrian (900 million to 543 million years ago) rocks similar to those in the Pinjarra Orogen in Western Australia beneath the area. This figure illustrates that the interior of the East Antarctic Craton may not be homogeneous, but rather is faulted and may comprise terranes of different ages and origins. The structural relationships may be a boundary condition for how and where lakes form and the extent to which they might be connected. SOURCE: Fitzsimons 2003.

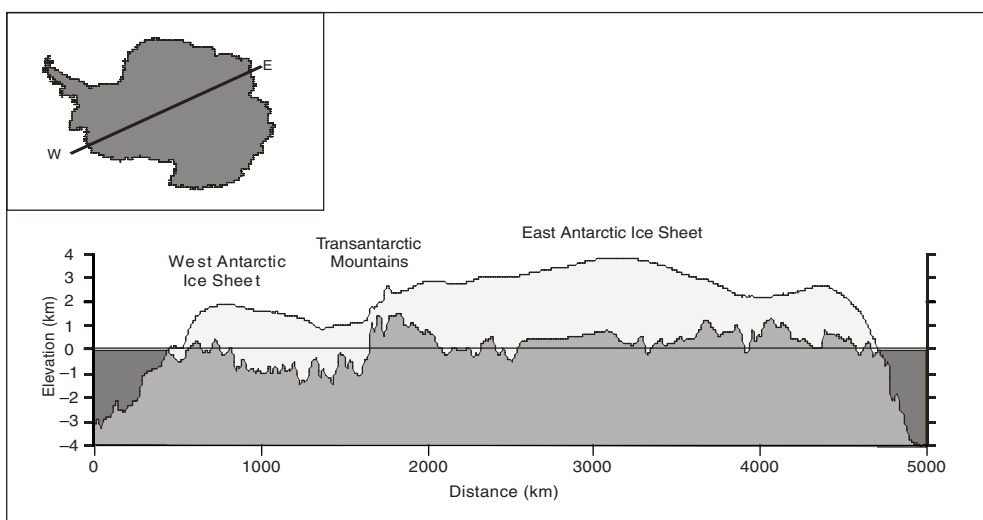

FIGURE 2.3 Cross-sectional profile of the Antarctic ice sheet based on BEDMAP bed topography (Lythe et al. 2001) and surface topography from Liu et al. (1999). Inset: Location of profile end points. SOURCE: Lythe, M. B., D. G. Vaughan, and C. BEDMAP: A new ice thickness and subglacial topographic model of Antarctica, *Journal of Geophysical Research B: Solid Earth*, 106 (B6): pp. 11335-11351 (2001). Reproduced with permission of American Geophysical Union. SOURCE: G. Clarke, committee member.

interior, has led to speculation that volcanism may have erupted through the craton as recently as Cenozoic times (Dalziel 2006). This hypothesized volcanism would likely be in a zone of high heat flow with potential to accelerate melting of the ice sheet in certain areas. It should be noted that most of these ideas are based on very few concrete data from the underlying rocks, and until samples of these rocks are obtained, speculation about the timing and processes by which these environments could have formed will remain.

### ICE SHEET DESCRIPTION

The Antarctic ice sheet accounts for roughly 90 percent of Earth's present ice volume (Church et al. 2001); it is bisected by the Transantarctic Mountains, which divide it into the high-standing and voluminous East Antarctic ice sheet (EAIS) and the low-standing but more dynamic West Antarctic ice sheet (WAIS). The platform upon which these two ice sheets lie is predominantly above sea level for the EAIS and below sea level for the WAIS, leading to the generalization that the EAIS is a terrestrial ice sheet and the WAIS is a marine ice sheet (Figure 2.3). Maximum ice thicknesses, exceeding 4 km, are encountered in the interior regions of the EAIS where the surface elevation is high and the resulting surface temperature is low.



The ice sheet flows by a combination of processes, some occurring within the ice mass and others at the boundary between the ice and its base. Plastic creep contributes significantly to the flow of the interior regions and tends to be a slow process, yielding flow rates in the range 1 cm to 10 m per year. Closer to the margins, a dendritic network of fast-flow arteries, termed “ice streams,” can develop. These have typical flow rates between 500 and 2000 m per year, and their fast flow is attributed to a combination of sliding over the bed and deformation of subglacial sediment. Where the Antarctic ice sheet flows into the surrounding ocean, ice can come afloat but remain intact to form an ice shelf that flows by thinning and spreading under the influence of gravity. Prominent examples are the Ross and Filchner-Ronne ice shelves that fringe the WAIS. The modes of flow outlined above are referred to as sheet flow, stream flow, and shelf flow, where different flow mechanisms dominate for each case. For the most part, shelf flow is relevant only to the floating margins of the Antarctic ice sheet, but it also operates over large subglacial lakes such as Lake Vostok where, as for ice shelves, the ice column is afloat and the lower boundary is free of frictional resistance.

The temperature distribution within an ice sheet is determined by surface temperature, ice thickness, ice flow, and geothermal heat flux. The mean annual surface air temperature for Antarctica is  $-36^{\circ}\text{C}$  (Giovinetto et al. 1990), with mean temperatures of the high interior region being as low as  $-55^{\circ}\text{C}$ . For the most part, the sediment and rock that form the continental platform of Antarctica are much warmer because they are shielded from cold surface temperatures by a kilometers-thick insulating blanket of glacier ice. The general tendency is for ice temperature to increase with depth until the bed is reached or the ice melting temperature is attained (Figure 2.4). This melting temperature depends on the ambient pressure (which is determined by the height of the ice column) and on the impurity content of the ice, both of which lower the melting temperature. For ice sheets, the pressure influence dominates and accounts for a  $0.0742^{\circ}\text{C}$  decrease in melting temperature per megapascal of pressure increase, roughly equivalent to a decrease of  $0.654^{\circ}\text{C}$  per kilometer of ice thickness.

Much of the base of the ice sheet is thought to be at or near the ice melting temperature. This conjecture is consistent with the bottom temperatures at the Byrd Station, Vostok, and Dome Concordia deep ice core sites (Gow et al. 1968; Petit et al. 1999; EPICA community members 2004) and is likely to be the case at the Dome Fuji site as well (Saito and Abe-Ouchi 2004). Melting temperatures also prevail at the bottom of all holes thus far drilled to the bed of active ice streams. As described earlier, extensive airborne radar sounding surveys, which allow the base of the ice sheet to be mapped in detail (e.g., Lythe et al. 2001), also indicate the extent of melting as revealed by the existence of subglacial lakes (Siegert et al. 2005a).

To extend these observations, other sources of information must be used. Computational models of the dynamics of the Antarctic ice sheet (Figures 2.5 and 2.6) indicate that large areas of the ice sheet base are at the ice melting temperature and that most areas are within  $5^{\circ}\text{C}$  of the melting point (which depends on ice pressure). The distribution of Antarctic subglacial lakes (Figure 2.6, black triangles) is broadly consistent with the predicted bed temperatures in Figure 2.6 whereas Figure 2.5 seems to be cold biased potentially resulting from modeling parameters. It is reasonable to conclude that over large areas the underlying sediment and rock are unfrozen and water saturated, and that storage and transport of subglacial water are to be expected.

The rate of basal melting corresponds to the rate at which a subglacial meltwater layer would thicken (e.g., in millimeters per year) if water flow was prevented. This

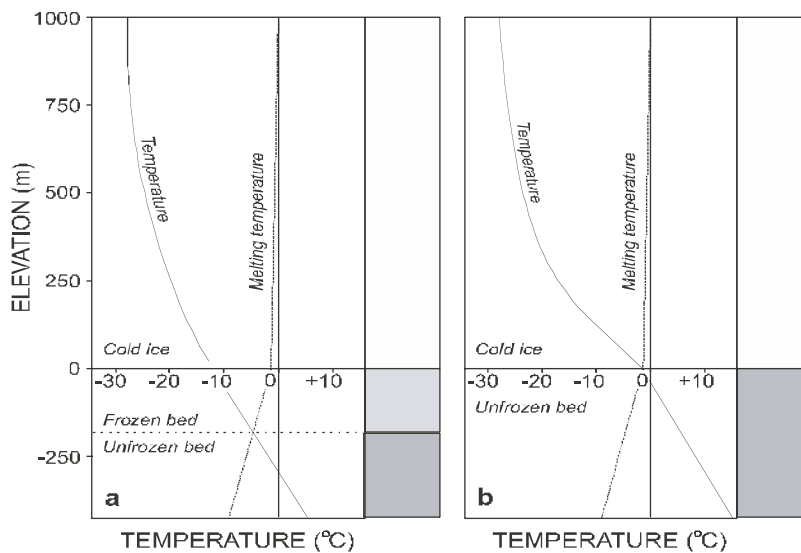

FIGURE 2.4 Diagrammatic profiles of ice temperature and ice melting temperature through an idealized ice sheet and its bed. (a) Frozen glacier bed with subglacial permafrost layer. (b) Melting glacier bed. SOURCE: G. Clarke, Committee Member.

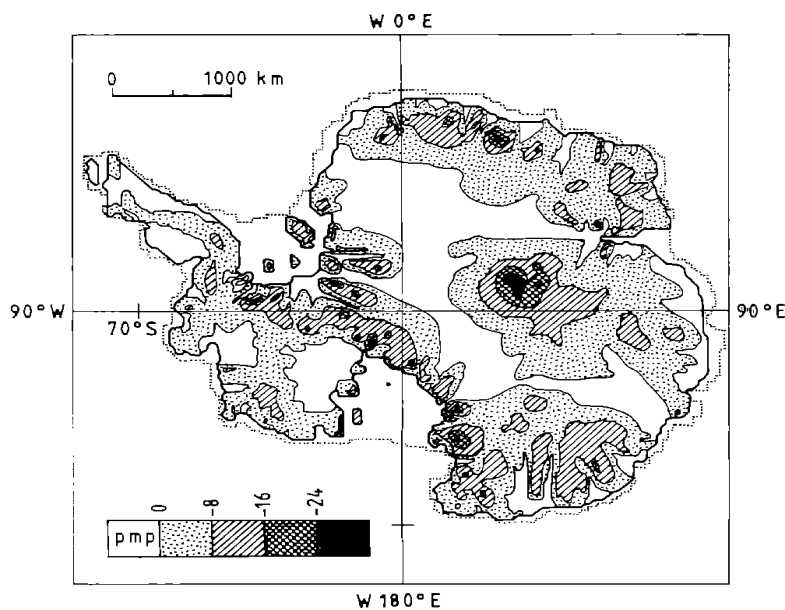

FIGURE 2.5 Map of bed temperature of Antarctic ice sheet (in degrees Celsius relative to the pressure melting temperature) as predicted by the numerical ice dynamics model. SOURCE: Huybrechts (1990).

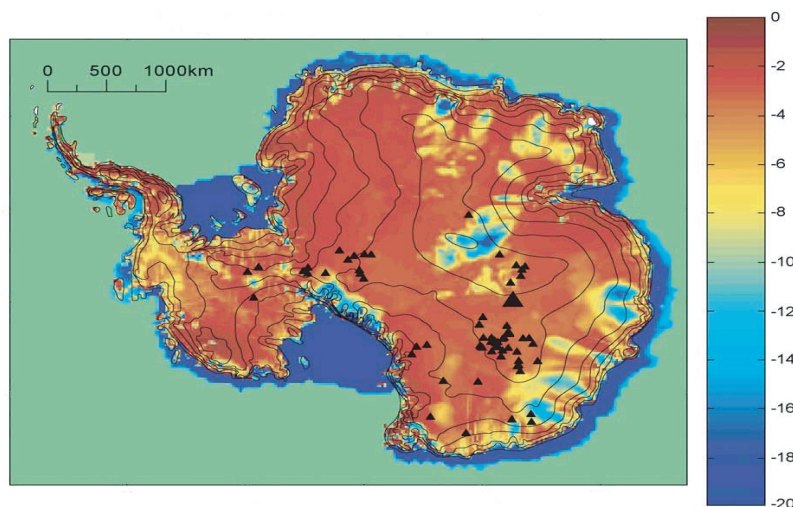

FIGURE 2.6 Map of basal temperature of Antarctic ice sheet (in degrees Celsius) as predicted by the numerical ice dynamics model of Siegert et al. (2005). Black triangles indicate the locations of known subglacial lakes, with the largest triangle corresponding to Lake Vostok. Because of the dependence of ice melting temperature on pressure, the melting temperature over large areas of the ice sheet interior is at or below  $-2^{\circ}\text{C}$ . SOURCE: *Global and Planetary Change*, 45, Martin J. Siegert, Justin Taylor, Antony J. Payne, Spectral roughness of subglacial topography and implications for former ice-sheet dynamics in East Antarctica Bristol Glaciology Centre, School of Geographical Sciences, 249-263, 2005, with permission from Elsevier.

rate is not directly observable but can be predicted using a thermomechanical ice dynamics model. Figure 2.7 presents results from one such model (Siegert et al. 2005). The figure shows the simulated average depth of the subglacial water layer but should be interpreted qualitatively rather than quantitatively because the calculation assumes a highly simplified subglacial hydrologic system. Nevertheless, to a first approximation, regions where the simulated water depth is large correspond to regions where the estimated melt rate is high.

## GEOGRAPHICAL LOCATION OF ANTARCTIC SUBGLACIAL LAKES

### Main Traits of Locations and Settings

About 80 percent of subglacial lakes reported to date in Antarctica lie at elevations less than a few hundred meters above sea level, while the majority of the remaining lakes are “perched” at higher elevations (Blankenship et al. 2006). Most of these lakes are in East Antarctica (Figure 2.8) with a few located along the continental margin between Victoria Land and Wilkes Land, and in the Transantarctic Mountains region where Precambrian basement was uplifted during the Cenozoic. Only four lakes have

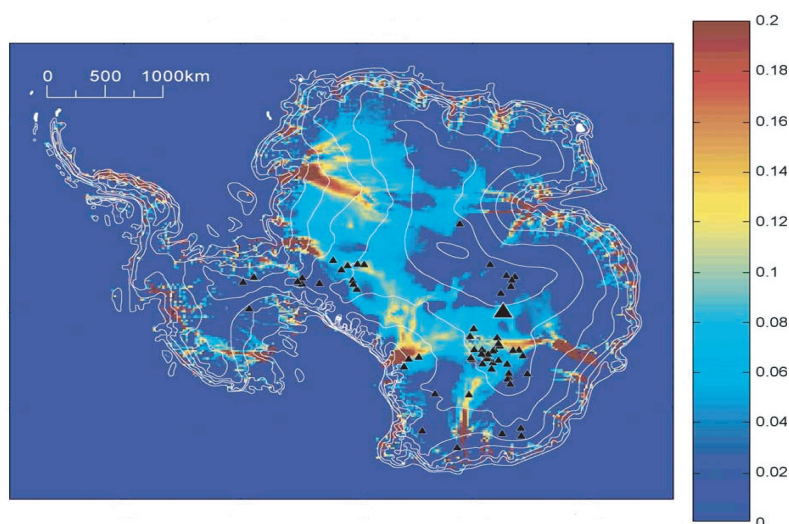

FIGURE 2.7 Average thickness of basal meltwater (in meters) as predicted by the numerical ice dynamics model of Siegert et al. (2005). The model assumes a highly simplified subglacial hydrological system and is best viewed as a qualitative indicator of regions where the basal melt rate is high. SOURCE: *Global and Planetary Change*, 45, Martin J. Siegert, Justin Taylor, Antony J. Payne, Spectral roughness of subglacial topography and implications for former ice-sheet dynamics in East Antarctica Bristol Glaciology Centre, School of Geographical Sciences, 249-263, 2005, with permission from Elsevier.

been reported so far in West Antarctica. One of these lies in the Byrd Subglacial Basin, between two crustal blocks, the Ellsworth-Whitmore Mountains and Marie Byrd Land. The other three lakes are located on the Ellsworth-Whitmore Mountains block and near its margin (Lake Ellsworth). This block is a former fragment of the Gondwanaland craton that rotated to its present position from the Weddell Sea margin of the continent. Hence all but one of the lakes reported to date are located on Precambrian crust (Dalziel 2006).

### Lake Districts

Figure 2.8 shows that Antarctic subglacial aquatic environments are clustered near the South Pole, and the Dome C, Ridge B, and Ellsworth-Whitmore Mountains areas. Blankenship et al. (2006) have found that 66 percent of all known Antarctic subglacial aquatic environments lie within 50 km of an ice divide, and some 88 percent of them are within 100 km of a local ice divide. Clusters of these environments in the Dome C and Ridge B areas are close enough to each other for interconnectedness to be possible, if not an absolute certainty. These groups of lakes are now sometimes referred to as “lake districts.”

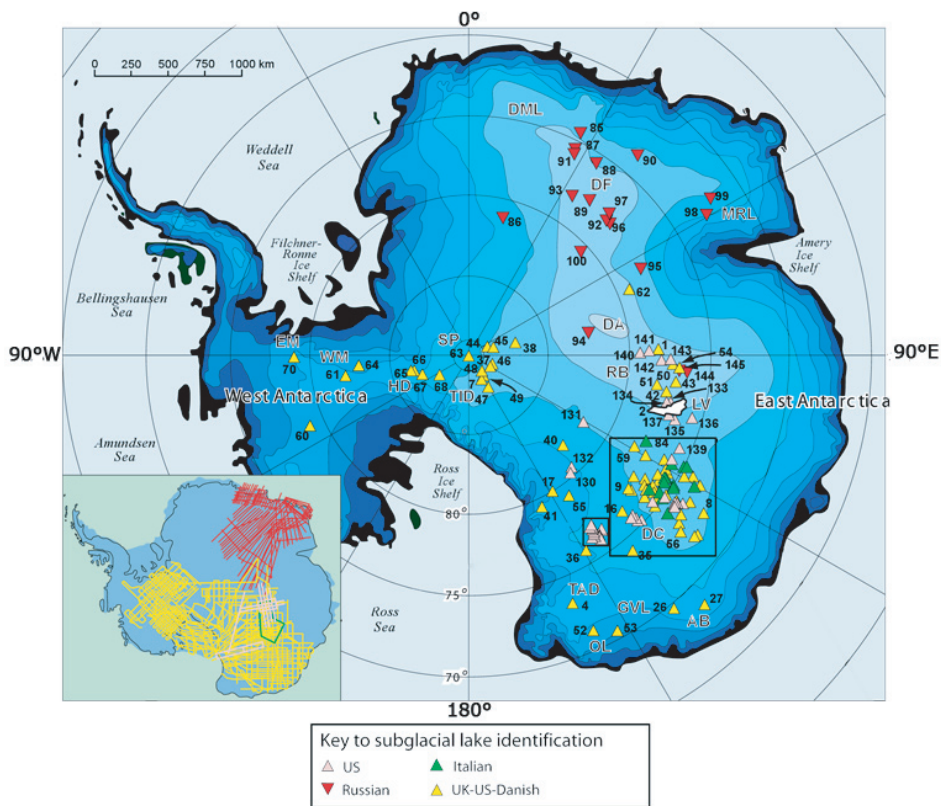

FIGURE 2.8 Locations of 145 Antarctic subglacial lakes. The distribution of subglacial aquatic environments is determined by the distribution of water and the availability of basins to collect water. The vast majority of subglacial aquatic environments identified to date are within 100 km of an ice divide. Major clusters of these environments are located in Dome C (DC) and Ridge B (RB) areas. The majority of these environments are small (less 20 km in length) with an average depth of 100 m. A few larger lakes may be up to 1000 m deep. Map inset shows distribution of radio-echo sounding flight lines. SOURCE: Modified from Siegert et al. (2005a). Reprinted with the permission of Cambridge University Press.

### Lake Size and Volume

Very few lakes, among them Lake Vostok, have been purposefully mapped, so in many cases a lake is traversed by a single radar flight line that provides no constraint on lake area, let alone lake volume. To estimate lake volume, radio-echo sounding (RES) measurements, which image the lake surface, must be complemented by some other geophysical technique such as seismic reflection sounding or gravimetric measurement. The former method is capable of mapping the topography of the lake floor, which returns a seismic reflection to the ice surface. The latter method is less precise and relies on the density difference between lake water and subglacial bedrock. It is not capable of resolving the detailed topography of the lake floor and works best for large lakes that

produce a large mass deficit. The subglacial lake with the best-determined geometry, Lake Vostok, is also the largest. The data used for this determination include several airborne radar surveys, one seismic reflection survey, and an aerogravity survey.

### PRE-ICE SHEET LAKES AND SEDIMENTS

There are no published studies on lakes that may have formed and sediments deposited prior to the development of the Antarctic ice sheet. At this stage, therefore, only questions exist about this possibility. The spatial extent and thickness of the sediments are unknown as are their physical and chemical characteristics. Are they primarily hemipelagic, turbiditic, or deltaic,—or a combination of all three? Are the sediments disrupted by faults, which would indicate relatively recent tectonic activity? Are the sediments conformable or do discontinuities exist? Does the geometry of these discontinuities reveal any information about the environment in which the sediments were deposited? Distinct groupings of sediment types indicate changing sediment input directions and/or tectonic-induced rotations. Erosional unconformities are likely to be associated with freezing of an entire lake and compaction and reworking of the sediments.

It has been suggested that Lake Vostok had a preglacial antecedent and, more controversially, that the lake has existed continuously from a time before Antarctica was extensively glaciated to the present day (Duxbury et al. 2004). Obviously, this would increase scientific interest in the lake and its biota, but there is uncertainty as to how such a lake might survive inundation by an ice sheet. Glaciological arguments for lake survival (Pattyn 2004) and against it (Siegert et al. 2004) have been advanced, but the issue remains unresolved. Quite independently, Erlingsson (1994a,b) developed the idea of a “captured ice shelf” overlying a “captured lake” to support his hypothesis that the Weichselian glaciation (90–15 kyr<sup>2</sup>) of the Baltic Sea resulted from expansion of a floating ice shelf rather than the advance of a grounded ice sheet. More recently, Alley et al. (2006) proposed a similar idea to explain how, during the same time period, repeated subglacial outburst floods might have originated from Hudson Bay.

### AGE OF LAKES AND WATER RESIDENCE TIME

Several different time scales are relevant to discussion of subglacial lake environments. These constrain the answers to the following questions: (1) What is the transit time for water deposited as snow on the surface of the ice sheet to be melted off the base of the Antarctic ice sheet and delivered to a subglacial lake? This establishes the degree of temporal separation between the surface and the subglacial environment and thus the age of microorganisms that are deposited in the lake by bottom melting. (2) What is the turnover time of water in a subglacial lake reservoir? This has relevance to how rapidly a subglacial lake can recover from accidental contamination. (3) What is the lag time between water exiting the lake and returning to a subaerial or submarine environment? This corresponds to the delivery time of contaminants to the global ocean and to the age of microorganisms flowing from the lake to the global ocean.

The age of the oldest ice at the base of the Antarctic ice sheet is comparable to that of the oldest ice in Antarctic ice cores, roughly 1 million years (EPICA 2004; Peplow

---

<sup>2</sup>Thousand years.

2006), plus the transit time from the interior to the periphery, which adds perhaps another 1 million years. Estimates of the residence time for water in a subglacial lake depend on the reservoir volume and the rate of water discharge into and out of the reservoir.

Water input to the lake comes from the influx of subglacial meltwater from the surroundings and from melting of the ice roof. Water output is the sum of water spilling out from the lake to the surroundings and water freezing onto the roof. Figure 2.9 presents the general case, in which all sources of input and output are active, and several limiting cases. The general case is likely to be the most prevalent because it is the least restrictive.

Estimates of the bulk turnover time  $\tau$  are independent of the specific nature of the influxes and are based on the ratio of volume  $V$  and input discharge  $Q^{\text{in}}$  as follows:  $\tau = V / Q^{\text{in}}$ . Conventionally,  $V$  is taken as the reservoir volume, but this would not be an appropriate choice if the reservoir is poorly mixed—for example, if input meltwater remains in close proximity to the lake roof. Thus, both  $V$  and  $Q^{\text{in}}$  may be poorly determined, but the main objective is to obtain rough rather than exact estimates of  $\tau$ , so for the present purposes this will suffice. Siegert (2005) estimates the residence time for Lake Vostok to be approximately 100,000 years.

The transit time for water that exits a subglacial lake to flow out to the ice sheet perimeter (escaping either as subaerial outflow or as direct submarine discharge to the Southern Ocean) depends on whether lake water is transported in solid form with the flow of the ice sheet (if the water is frozen onto the base of the ice sheet) or in liquid form via a subglacial water flow system. Solid-phase transport is the slow process, and for this process in Antarctica, the maximum transport time is roughly 1 million years. For the fast process, assuming a water flow velocity of  $1 \text{ mm s}^{-1}$  and a travel distance of 2000 km (Figure 2.3), the transport time is roughly 50 years. Here, the major point is that when water from subglacial lakes flows to the global ocean it is unlikely to be more than several million years older than the snow falling on the ice sheet surface. This time scale is relevant to the maximum degree of genetic divergence between organisms deposited on the ice sheet surface and organisms transferred from the ice sheet to the global ocean.

### LAKE CONNECTIVITY

The extent to which Antarctic subglacial lakes are interconnected has important implications for their scientific interest as well as for their environmental stewardship. If the lakes are hydraulically isolated, then in principle a variety of distinct subglacial environments could develop and the consequences of chemical or biological contamination would be localized. If the lakes are highly interconnected, as they would be if they were part of a pervasive subglacial hydrologic system, then environmental diversity would be decreased, the effects of dilution would be increased, and in terms of impacted area, the consequences of contamination would be increased. These extremes of connectivity might be termed the “repository model” (as in Figure 2.9) and the “watershed model” (as in Figure 2.9).

Much of the speculation concerning the scientific interest of Lake Vostok has been guided by the repository model. Yet there is little compelling evidence to support this assumption. The behavior of water beneath warm-based valley glaciers and ice caps is well described by the watershed model, and examples of long-term subglacial water

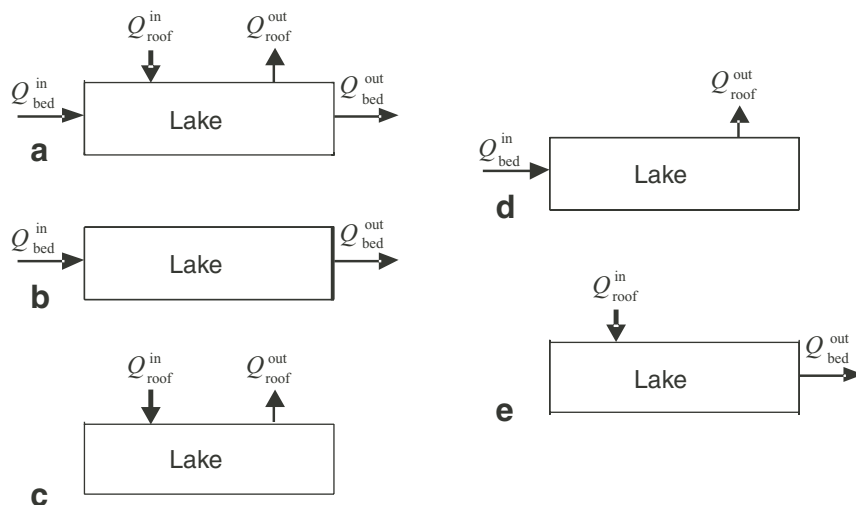

FIGURE 2.9 Water balance in subglacial reservoirs. (a) The general case in which water is received and delivered from the subglacial environment and from melting and freezing processes operating at the roof. (b) Input discharge from upstream subglacial melt sources is balanced by output discharge to the downstream subglacial environment. (c) Melting and freezing processes in the lake exactly balance with no external sources or sinks. (d) Input discharge from the subglacial environment is balanced by freeze-on at the lake roof. (e) Roof melting is balanced by discharge from the lake to the downstream subglacial environment. SOURCE: G. Clarke, Committee Member.

repositories are rare or nonexistent. Evidence suggests that Lake Vostok is long-lived and, on the millennial scale, stable, but this cannot be generally true of subglacial lakes. Wingham et al. (2006) present strong evidence for the episodic discharge from a deeply buried Antarctic subglacial lake into two receiver lakes situated at least 290 km downstream from the source lake. This observation is consistent with previous (Gray et al. 2005) and very recent (Fricker et al. 2007) observations of subglacial water discharge events occurring beneath West Antarctic ice streams. As a default position, one must accept that lake-to-lake connectivity could be the norm rather than the exception. The implication of this is that a basin-scale analysis of hydrologic catchments is necessary before lake-to-lake interactions can be critically examined.

### Water System at Ice-Bed Interface

The fate of flowing subglacial water is strongly constrained by the well-established physics of fluid mechanics. It can be shown that the flow of water at the ice-bed interface is driven by the bed slope gradient  $\gamma_{bed}$  and the ice surface slope gradient  $\gamma_{surf}$  and that the surface slope  $\rho_{ice}/(\rho_{water} - \rho_{ice})$  is approximately 8 times more effective in directing subglacial water flow than the bed slope. This result has important ramifications for subglacial water routing because it implies that, to a first approximation, subglacial



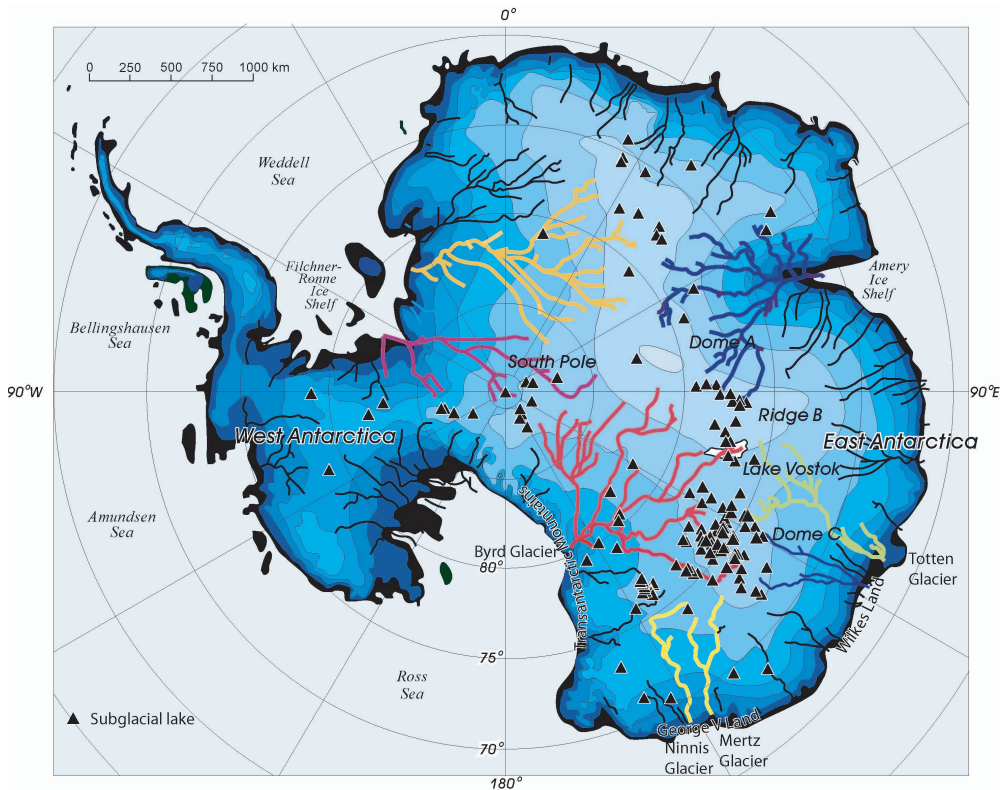
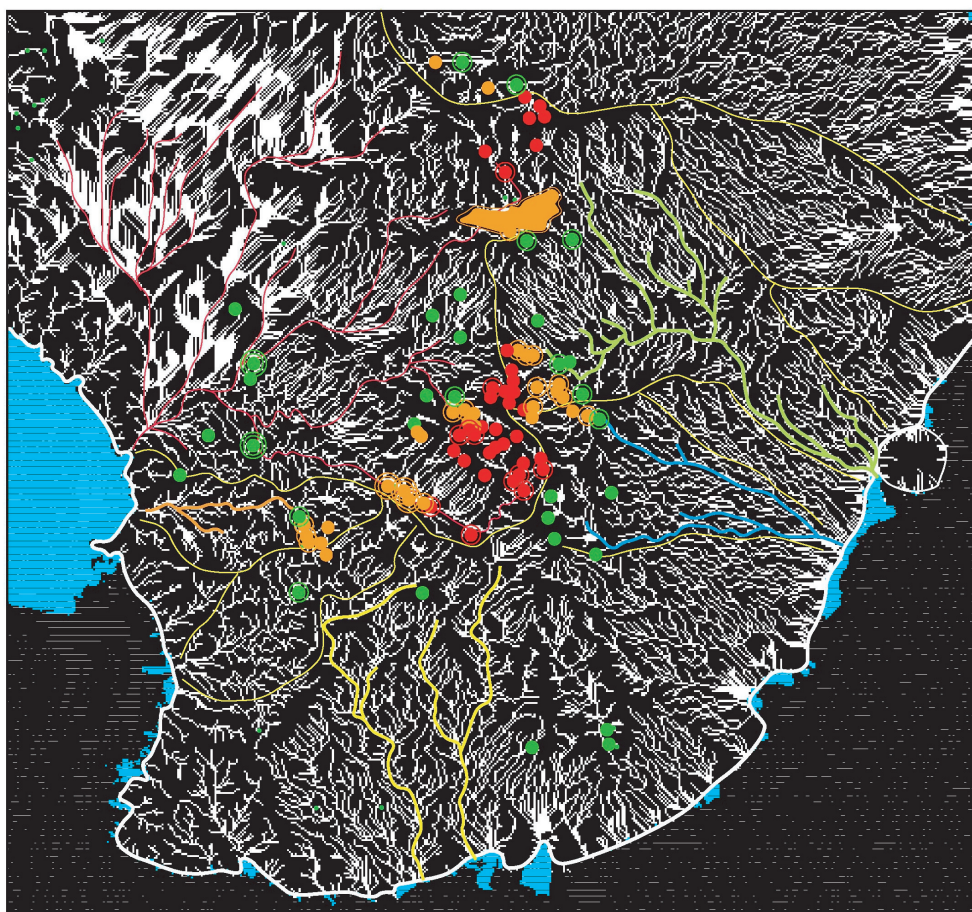

FIGURE 2.10 Locations of known Antarctic subglacial lakes and predicted major drainage routings. SOURCE: Siegert et al. 2007.

water flow follows the ice surface slope. Ice flow is known to follow the surface slope so the implication of the above is that subglacial water routing is closely similar to the routing of the ice flow, both being determined by the ice surface topography.

With knowledge of both the ice surface topography (e.g., Liu et al. 1999) and the bed topography (e.g., Lythe et al. 2000) and the use of a standard water flow routing algorithm, it is possible to delineate large-scale drainage basins for subglacial water flow (Figure 2.10). The same approach can be applied at a finer spatial resolution in regions where high-resolution surface and bed elevation data are available (Figure 2.11).

It has yet to be demonstrated that flow routing algorithms that have been developed for subaerial flows can reliably predict subglacial routings because the situations are not completely analogous. Subglacial flows are not exclusively guided by geometry but are subject to permeability barriers (e.g., frozen beds) that have no subaerial counterpart. Nevertheless such analyses can provide useful information on the expected water pathways and the possibility of interconnection between lakes. For example, according to Figure 2.10, water flowing from Lake Vostok would be routed toward the outlet



- Lakes that are downstream of <2 lakes
- ⊙ Lakes that are downstream of 2-5 lakes
- ⊙ Lakes that are downstream of >5 lakes
- Lakes that are upstream of >5 known lakes
- Lakes that are upstream of 5-2 lakes
- Lakes that are upstream of <2 lakes

FIGURE 2.11 Calculated routings for subglacial meltwater based on surface and bed topography in the Dome C and Ridge B region of East Antarctica and application of a flow routing algorithm. SOURCE: Siegert et al. 2007.

of Byrd Glacier in West Antarctica, and according to Figure 2.11, lakes in the Ridge B-Dome C region of East Antarctica would be expected to manifest a large degree of interconnectivity.

Finally, using satellite radar altimetry, very accurate digital elevation models (DEMs) of the ice sheet surface can be generated, and from these, the faint traces of subglacial hydrological networks can be extracted using a surface curvature detection algorithm (Rémy and Legrésy 2004). Whether interconnectivity is continuous or sporadic is a separate question. The observation of Wingham et al. (2006), is best interpreted as a subglacial outburst flood that, over the course of 16 months, transferred  $1.8 \text{ km}^3$  of water from one basin to others downslope from it. The situation is somewhat analogous to jökulhlaups that catastrophically release meltwater stored beneath Icelandic ice caps (Björnsson 2002) and for which there is a sizable observational and theoretical literature. Inspired in part by the Wingham et al. result, efforts are under way to adapt existing theory to deal with such floods (Evatt et al. 2006).

### Groundwater Routing

Groundwater flow is driven by gradients in the hydraulic potential that, in turn, are governed by the surface and bottom geometry of the ice sheet. Water transport following a groundwater routing is driven by the same hydraulic potential gradient that drives water flow along the ice-bed interface, so the relative importance of groundwater flow depends on which mechanism is more effective and under what circumstances.

In regions where the bed is at the melting temperature, the sheet and groundwater flow systems can coexist and both systems experience roughly the same hydraulic potential gradient. Which system dominates will depend on the hydraulic conductivity of the subglacial materials. As is apparent from Table 2.1, the natural range for hydraulic conductivity is extremely large. For back-of-the-envelope estimates, a value of  $10^{-6} \text{ m s}^{-1}$  is taken. There are doubtless regions in which significantly higher values apply, but regions where the hydraulic conductivity is low are likely to control the overall flow rate. By a simple calculation it can be shown that a 1-mm-thick water sheet is as effective as a 460-m-thick aquifer, having a hydraulic conductivity of  $10^{-6} \text{ m s}^{-1}$ . Thus, when sheet flow is possible it is far more effective at transporting water than groundwater flow unless the aquifer is highly conductive or very thick.

TABLE 2.1 Representative Values of Hydraulic Conductivity of Various Rock Types

Rock Type	Hydraulic conductivity ( $\text{m s}^{-1}$ )
Limestone, dolomite	$1 \times 10^{-9} - 6 \times 10^{-6}$
Sandstone	$3 \times 10^{-10} - 6 \times 10^{-6}$
Siltstone	$1 \times 10^{-11} - 1.4 \times 10^{-8}$
Shale	$1 \times 10^{-13} - 2 \times 10^{-9}$
Permeable basalt	$4 \times 10^{-7} - 2 \times 10^{-2}$
Fractured igneous and metamorphic rock	$8 \times 10^{-9} - 3 \times 10^{-4}$
Weathered granite	$3.3 \times 10^{-6} - 5.2 \times 10^{-5}$
Weathered gabbro	$5.5 \times 10^{-7} - 3.8 \times 10^{-6}$
Basalt	$2 \times 10^{-11} - 4.2 \times 10^{-7}$
Unfractured igneous and metamorphic rocks	$3 \times 10^{-14} - 2 \times 10^{-10}$

SOURCE: Excerpted from Domenico and Schwartz (1990).

Where the ice-bed interface is below the freezing point, a sheet flow system cannot develop, but groundwater flow can proceed through unfrozen material beneath the ice sheet (Figure 2.4). A representative value of the geothermal gradient in frozen subglacial rock or sediment is  $30^{\circ}\text{C km}^{-1}$ .

Thus, if the base of the ice sheet is  $3^{\circ}\text{C}$  below the freezing point, the subglacial material is expected to be frozen to a depth of approximately 100 m below the base of the ice sheet. For this case, the upper boundary of the groundwater flow system would therefore lie 100 m below the bed of the glacier.

### CIRCULATION AND STRATIFICATION

Although subglacial lakes are isolated from direct wind-induced mixing, a variety of other hydrodynamic mechanisms can operate within the lakes. Subglacial lake circulation results from endogenous processes that drive water from one part of the lake to another and exogenous processes such as “riverine” fluxes to and from a subglacial hydrologic system that extends beyond the lake margins. Subglacial water flow is well known from Arctic glaciological studies and has been inferred in many parts of Antarctica (e.g. Gray et al. 2005) including into subglacial Lake Concordia (Tikku et al. 2005). There is also evidence of water flow between adjacent subglacial lakes in Antarctica (Wingham et al. 2006; Fricker et al. 2007). Such transfers provide an additional source of momentum to generate within-lake advection and turbulent diffusion, as well as a mechanism that may disperse contaminants among lakes. If the inflow is denser than the lake water at the point of entry because of its temperature, salinity, or suspended sediments content, then it will sink to the bottom of the lake or to a depth of equal density. River-derived overflows, underflows, and interflows are features of lakes at all latitudes, and the resultant density plumes can be much larger than the inflow discharge because of turbulent entrainment of the surrounding water (e.g., Vincent et al. 1991).

The endogenous circulation of subglacial lakes is driven by small gradients in the potential energy of lake water that can result from vertical or lateral gradients in water density. This density depends on the pressure, temperature, and salinity of water, which can be approximated by experimentally based equations of state (e.g., Chen and Millero 1986). The pressure of subglacial meltwater is well constrained and should closely approximate the hydrostatic pressure of the overlying ice and water. Temperature is also reasonably well constrained, but not without complication. For example Souchez et al. (2000) extrapolated the ice temperature profile for the Vostok core hole and estimated the lake temperature to be  $-3.1^{\circ}\text{C}$ , some  $0.6^{\circ}\text{C}$  lower than the freezing temperature of freshwater at pressures comparable to that in the lake. Salinity is the least constrained of the three density dependents.

The combination of a sloping ice ceiling with large-scale lake circulation can establish conditions for vigorous melting and freezing at the ice-water contact. These “glaciohydraulic” processes are associated with the pressure dependence of the ice melting temperature and are known to be active beneath floating ice shelves (e.g., Jenkins and Doake 1991) and in subglacial drainage channels that have adverse slopes (Alley et al. 1998; Lawson et al. 1998). Their importance to subglacial lakes is that they can lead to unexpectedly high rates of melting and accretion—far exceeding the rates that might be explained by plausible variations in geothermal flux. The consequence for subglacial Lake Vostok is that parts of the ice ceiling are subjected to melt rates as high

as 38 cm per year while other parts are subjected to freeze-on at as much as 6 cm per year (Siegert et al. 2000). By coincidence, the Vostok 5G core hole is situated above a region where the upstream accretion rate is high and the total thickness of accreted lake ice exceeds 200 m (Jouzel et al. 1999).

Salt inputs to subglacial lakes must come from one of two sources: (1) the melt of glacier ice entering the lake, or (2) chemical weathering and dissolution of previously deposited subglacial salts by groundwaters (including sediment pore water). Several indirect lines of evidence suggest that the solute content of Lake Vostok is very low. Chemical analysis of lake ice recovered from the Vostok ice core at depths below 3539 m indicates that the accreted ice has a salinity of roughly 0.001 parts per thousand. The freezing process tends to concentrate solute in the liquid phase so that water salinity will exceed ice salinity, with the chemical partitioning between the two phases governed by a distribution coefficient. On this basis, Souchez et al. (2000) predicted that the average salinity of Lake Vostok was 0.4-1.2 parts per thousand (in contrast to 35 parts per thousand for ocean water). Using different reasoning, Gorman and Siegert (1999) found that Lake Vostok was comparatively transparent to 60-MHz electromagnetic waves and argued that the electrical conductivity, and thus the salinity, of the lake water must be extremely low. Using RES data of ice thickness, and satellite altimetry, Kapitsa et al. (1996) evaluated the flotation of the ice over Lake Vostok and concluded that the lake water is “relatively fresh.”

Although measurements of the chemistry of accreted ice near the base of the Vostok ice core provide strong evidence for low-salinity lake water, the hypothesis is not free of difficulties. If the temperature extrapolation of Souchez et al. (2000) is correct, higher-salinity water is inferred because increased salinity depresses the temperature of freezing. The low-salinity hypothesis also raises questions about the residence time of lake water and how low salinity can be maintained. If the accretion of lake water ice to the base of the ice sheet concentrates solute in the lake, then salinity should rise over time in the same way that evapoconcentration causes the accumulation of salt in endorheic lakes (terminal lakes that have no outlet). For a lake to maintain itself as a low-salinity water body there must be processes by which salts can be removed, for example, by outflow of lake water to the subglacial surroundings. Furthermore, the accretion ice is formed from the uppermost waters of Lake Vostok where the lowest-density water will occur. If any salt stratification is present in the lake, the accretion ice will capture the signature of the lowest-salinity water in the lake.

As recognized by Wüest and Carmack (2000), the nature of the circulation of subglacial lakes is dependent on the depth of burial of the lake; the chemistry of its water; the magnitude of the geothermal flux through the lake; and the size, geometry, and geographic latitude of the reservoir (Figure 2.12). The omnipresent geothermal flux establishes a temperature gradient between the floor and ceiling of the lake. An important issue is whether heat and solutes are transported mainly by thermal and chemical diffusion or by convection because this determines whether vertical mixing is weak or vigorous. If diffusion processes dominate, the lake can maintain large thermal and chemical gradients and a stratified structure can develop. If the lake is vigorously convecting, temperature and salinity contrasts will be suppressed. It should be noted that Wüest and Carmack (2000) created their model for a single basin, and Lake Vostok is now known to have two basins divided by a shallow sill (Studinger et al. 2004).

Whether Antarctic subglacial aquatic environments are “lake-like” or “ocean-like” in their structure and convective circulation depends strongly on their salinity and depth

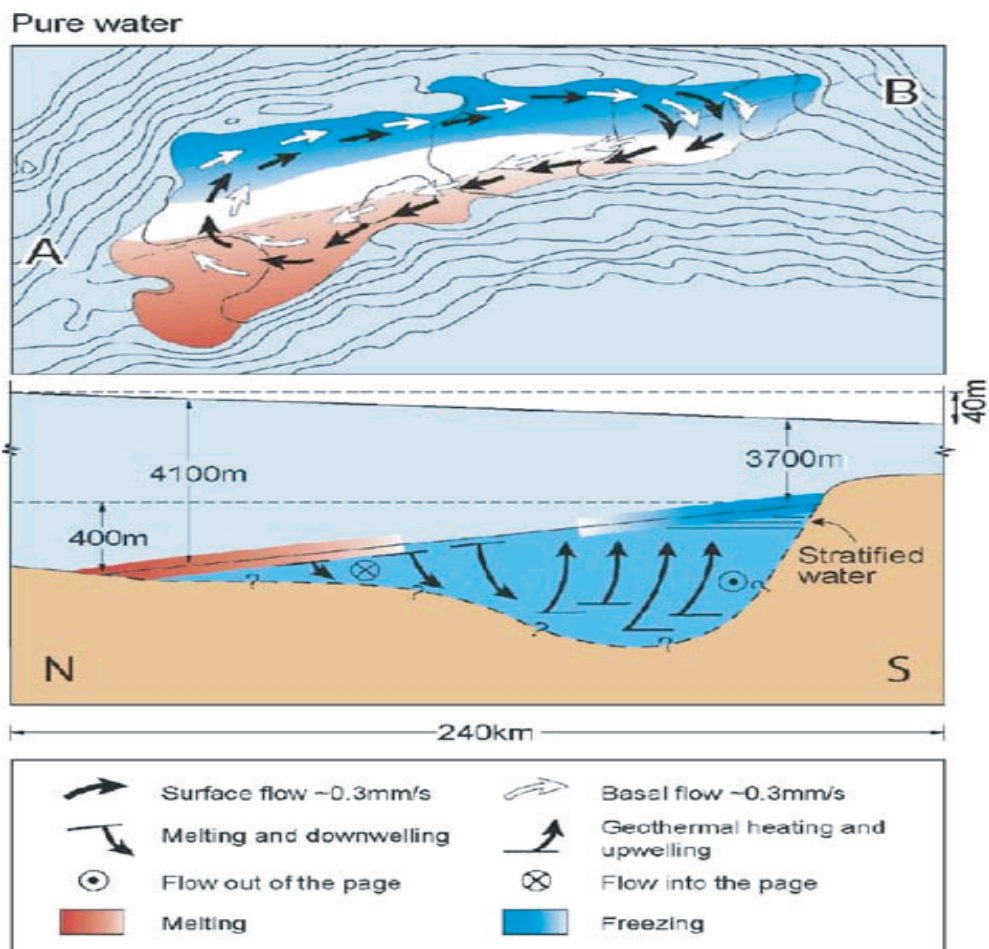

FIGURE 2.12 Conjectured circulation pattern for Lake Vostok assuming that it has low salinity and the flow is driven by thermally induced density gradients in the lake (after Siegert 2005). SOURCE: Reprinted, with permission, from the Annual Review of Earth and Planetary Sciences, Volume 33 ©2005 by Annual Reviews [www.annualreviews.org](http://www.annualreviews.org).

of burial (Wuest and Carmack 2000). At pressures exceeding 28.4 MPa (3170 m of ice cover) the maximum density of freshwater occurs at the freezing temperature and the water body is ocean-like, irrespective of its salinity. This should be the case for Lake Vostok, which lies beneath 3700-4300 m of ice. Furthermore, the mean water depth for Lake Vostok is around 360 m (Studinger et al. 2004), so even a conservative estimate of the flow Rayleigh number (an indicator of the degree of convective instability) would suggest that vigorous thermal convection is occurring over much of the lake. If this is the case, then vertical mixing should be effective and reduce any vertical gradients in chemical and biological properties.

The effect of bottom heating through the usual geothermal flux of about  $0.05 \text{ W m}^{-2}$  will differ among subglacial lakes depending on the thickness of the overlying ice cover (Wüest and Carmack 2000). Because the temperature of freezing ( $T_F$ ; water at the ice-water interface should be close to this temperature) and the temperature of the maximum density of water ( $T_{MD}$ ) are both functions of pressure. For freshwater at pressures below 2840 dbar (equivalent to 3170 m thickness of ice, assuming an ice density of  $913 \text{ kg m}^{-3}$ ),  $T_{MD}$  is greater than  $T_F$ . The geothermal heat flux will warm the bottom waters to temperatures above  $T_F$  thereby increasing its density toward that of  $T_{MD}$ , and this will result in a stable, density-stratified water column. This stratification pattern is commonly observed in ice-covered freshwater lakes (e.g., Anguissaq Lake, Greenland, beneath 3 m of perennial ice; from Hobbie 1973) where the inverse temperature gradient is maintained by heat losses from the top of the water column to the overlying ice and atmosphere. A large number of the subglacial lakes detected so far have ice thicknesses less than 3170 m and could be stratified; however many have much thicker ice, including Lake Vostok. In this class of freshwater subglacial lakes,  $T_{MD}$  is less than  $T_F$ . Geothermal heating of the bottom water will decrease its density and result in buoyant turbulent plumes. For a freshwater column in Lake Vostok, Wüest and Carmack (2000) calculated that the vertical velocities within these convective plumes would be around  $0.3 \text{ mm s}^{-1}$ , which would completely mix the water column over a period of days. Geothermal vents and localized hot spots in the lake would increase these rates of mixing substantially, and the input of gas bubbles and warm hydrothermal fluids would further amplify the degree of vertical circulation.

Density currents induced by differential heating and cooling are well known in temperate latitude lakes (e.g., Monismith et al. 1990) and have also been observed in ice-capped lakes caused by spatial variations in solar heating (Matthews and Heaney 1987). In subglacial lakes, horizontal differences in temperature and thus density could be induced by inflows, local variations in the geothermal heat flux, or any tilting of the ice ceiling over the lake. The latter effect has been modeled for Lake Vostok where there is a 460-m difference in ice thickness between the north and south ends of the lake, leading to an estimated  $0.31^\circ\text{C}$  difference in upper water temperatures along its 230-km length. Wüest and Carmack (2000) calculated that this would lead to pressure-driven horizontal flows of  $0.3$  to  $0.6 \text{ mm s}^{-1}$  (up to about 20 km per year), with the strength of this horizontal circulation dictated by heat fluxes at the ice-water interface, the extent of tilting of the ice, and Coriolis force. These calculations were subsequently extended using a numerical, three-dimensional ocean circulation model, which confirmed that weak basin-wide circulation would take place, with local variations in the velocity field and a strong influence of bathymetry (Williams 2001).

The same approach using the most accurate bathymetric data available for Lake Vostok predicted anticyclonic flow of about  $4500 \text{ m}^3 \text{ s}^{-1}$  in the northern and southern parts of the lake and a cyclonic gyre in its center with velocities of around  $0.1 \text{ cm s}^{-1}$  (Mayer et al. 2003). Modification of the model from freshwater to saline conditions showed that even low salinities ( $1.2\text{‰}$ , about 3.4 percent seawater) resulted in a stratified water column in which large vertical gradients in temperature could develop. The gain or loss of freshwater through melting and freeze-up at the ice-water interface under these saline conditions drove a more intense horizontal circulation pattern and reduced the horizontal turnover time scale from 20 years (freshwater conditions) to 11 years (Mayer et al. 2003).

Density currents can also be generated by localized high solute and particle concentrations. Salts and other materials are partially excluded from the ice during freeze-up (e.g., Belzile et al. 2002), and this can give rise to dense water at the ice-water interface that then sinks deeper into the water column.

This mechanism is well known in polar oceans, for example in the Siberian flaw polynyas where this ice exclusion process results in saline, organic-rich plumes that transport water from the surface to more than 2000-m depth in the Arctic Ocean (Dittmar 2004). This mechanism also contributes to thermohaline convection and the formation of hypersaline bottom waters in meromictic high-latitude lakes that experience large quantities of ice production each year (e.g., Ace Lake in the Vestfold Hills Antarctica [Gibson et al. 2000] and Romulus Lake in the Canadian High Arctic [Van Hove et al. 2006]).

Small-scale double diffusion cells caused by the two-order-of-magnitude difference in molecular diffusion rates for salt versus heat (conduction) can expand and extend over considerable depth. This process has attracted considerable interest in perennially ice-covered McMurdo Dry Valley lakes, particularly Lake Vanda where a staircase series of isohaline, isothermal convection cells up to 20 m thick occur in the upper water column, each cell sandwiched between layers of temperature and salinity gradients (Spigel and Priscu 1998). Radiotracer experiments on the largest of these cells showed that there were strong horizontal currents with velocities up to  $1 \text{ cm s}^{-1}$  accompanied by vertical turbulent mixing (Ragotzkie and Likens 1964).

Although this variety of hydrodynamic mechanisms is likely to disperse contaminants both vertically and horizontally, full homogeneous mixing throughout the water body seems unlikely for all but the smallest of subglacial lakes, and dilution of any contaminant may be much lower than the mixing ratio calculated for the total lake volume. Many of these mechanisms generate local variations in temperature, salinity, and mixing regimes, and the rate of dispersion will vary within as well as among subglacial water bodies.

Stratification of the water column by salinity gradients will greatly dampen vertical mixing processes. For example, some Arctic (Van Hove et al. 2006) and Antarctic (Spigel and Priscu 1998) ice-capped lakes have unusual temperature profiles, with deep thermal maxima that are well above their mean or even maximum summer air temperatures. These profiles are stabilized by strong salinity gradients, from freshwater beneath the ice to salinities at or above seawater at the bottom of the lake. Both the shape of the profiles and the magnitude of the thermal maxima can be simulated accurately by models that describe long-term (decades to millennia) solar heating in the absence of turbulent mixing (Shirtcliffe and Benseman 1964).

Despite the apparent stability of such density-stratified lakes, however, there is evidence of some vertical exchange. Studies on Lake Fryxell, an ice-covered, meromictic lake in the McMurdo Dry Valleys, have shown the presence of the atmospheric contaminant chlorofluorocarbon-113 (CFC-113) even in the saline bottom waters of the lake, implying some transport to depth by convective mixing processes (Tyler et al. 1998).

### Refrozen Ice

In 1999, deep ice core drilling at Vostok was halted at a depth of 3623 m, some 127 m above the upper surface of Lake Vostok. Below 3539 m, lake ice was encoun-



tered in the ice core and the scientific motivation for continued drilling and ice core analysis switched from climatology to limnology and microbiology. Airborne radar sounding surveys over Lake Vostok reveal that the lake surface is characterized by distinctive zones where ice melting or freeze-on dominate (Siegert et al. 2000; Bell et al. 2002; Tikku et al. 2004). These regions are thought to be related to the sloping ceiling of the lake and the associated pattern of water circulation (Wüest and Carmack 2000). It is entirely fortuitous that the Vostok core site is situated over a region where ice freeze-on dominates; at other sites, basal melting might have prevailed.

Freeze-on of lake water to the ice ceiling of subglacial lakes results in partitioning of water isotopes and chemical impurities between the solid and liquid phases. The heavy isotopes of hydrogen and oxygen are concentrated in the solid phase, whereas chemical impurities are concentrated in the lake. In contrast, the ice melting process is completely unselective: the isotopic and chemical composition of the meltwater is identical to that of melted ice.

The concentrations of particulates and solutes in the surface waters of Lake Vostok have been estimated from analyses of lake-derived accretion ice and from partition coefficients that express the ratio of concentration of each substance in the ice relative to water. During freeze-up, the crystal lattice of the ice expels and concentrates materials into the remaining water, and partition coefficients are therefore always less than 1. For Lake Vostok calculations, Christner et al. (2006) used the following values derived from measurements in ice and water in Lake Bonney, in the McMurdo Dry Valleys: 0.40 (particulate organic carbon), 0.56 (bacterial cell concentrations), 0.0021 ( $\text{Na}^+$ ), 0.022 ( $\text{K}^+$ ), 0.0026 ( $\text{Ca}^{2+}$ ), 0.0022 ( $\text{Mg}^{2+}$ ), 0.0023 ( $\text{Cl}^-$ ), and 0.00083 ( $\text{SO}_4^{2-}$ ). Larger solutes including complex organic molecules are excluded to a greater extent than smaller solutes (Belzile et al. 2002), and it is therefore puzzling that the coefficients for large particulates such as bacterial cells are so much higher than for solutes, suggesting that other processes are operating in the Bonney environment (e.g., bacterial growth in the ice) or that particulate incorporation is governed by more complex interactions during freeze-up than simple size exclusion (e.g., ice nucleation by POC and bacteria). The degree of freeze concentration increases with decreasing rates of freeze-up (Killawee et al. 1998): slow ice formation results in more efficient exclusion of materials. Christner et al. (2006) note that freeze-up in Lake Vostok is likely to be an order of magnitude slower than in Lake Bonney; therefore, application of the Bonney partition coefficients will result in potentially large underestimates of the dissolved and particulate concentrations that actually occur in the Vostok surface waters.

### Inclusions

Somewhat surprisingly, mineral inclusions have been identified in the lake ice section of the Vostok core. Inclusions are likely to come mostly from the edges of the lake or from shoals (areas close to the pressure melting point). These inclusions are most highly concentrated in the upper portion of the accreted ice and appear to be absent below 3609 m (Jouzel et al. 1999). The ice flow trajectory in this region of Lake Vostok is south-southeast (Tikku et al. 2004), and the flow line that passes through the Vostok core site is presumed to traverse a shoal along the western shore of the lake where ice accretion is occurring. Toward the Vostok site, and farther from the shoreline, the freeze-on process is still active, but ice is afloat and no longer in mechanical contact with portions of the glacier bed.

## SEDIMENT ENVIRONMENT

Seismic data have been used to estimate a 300-m thickness of sediments near Vostok Station (Popkov et al. 1998). The lake sediments could contain an unparalleled record of Antarctic paleoenvironmental information, extending well beyond the limit of ice core records.

Lake sediments enter subglacial systems by one of two primary pathways: (1) melt-out of ice-entrained sediment as glaciers melt at their base, or (2) “bulldozing” of basal sediment into the lake basin by subglacial sliding. Authigenic sedimentation could also be occurring in the lakes. Sediment delivered by the first mechanism may contain refrozen basal sediment and atmospheric fallout from the time the glacial ice formed, and it may also contain micrometeorites and cosmic dust (e.g., interplanetary dust particles and cometary debris).

From a stratigraphic and geochronological perspective, the sediment of subglacial lakes is very different from sediments previously studied in lakes and oceans. A complication of inferring paleoclimate from Lake Vostok sediments is that any atmospheric input to the lake is delayed by hundreds of thousands of years, possibly up to 1 million years, which is the expected maximum age of basal ice (Siegert et al. 2001). The length of this delay will vary with internal ice sheet dynamics, and the contributions from the different sediment sources will be on very different time scales. Certainly particle-size-specific analysis will play a key role, since we would expect the atmospheric contribution to be very fine-grained in comparison to the sediments generated through bulldozing of basal sediments.

Because of the unique depositional pathways of subglacial lake sediments, most standard geochronological techniques cannot be used in these environments. If the goal is to establish when given layers in a sediment profile were laid down, paleomagnetism seems particularly well suited to this problem because as grains settle to the lake bottom, they will be aligned with the contemporary magnetic field. A more thorough consideration of the Lake Vostok sediment environment is given by Doran et al. (2004).

### Sediment Flux and Rate of Reservoir Sedimentation

The rate of geologic transport of subglacial sediments into subglacial lakes determines the time required to fill the lake with sediment (hence a limit on its lifetime). Additionally, the comparative importance of the influx of chemicals and microbes to subglacial lakes by subglacial sediment transport and the influx, by melting, require assessment. The situation will vary from lake to lake, but Lake Vostok can be taken as the type example. For rough calculations, take the long axis of Lake Vostok to be 250 km, the volume  $5000 \text{ km}^3$ , and the surface ice flow rate transverse to the long axis 4 m per year. If this surface ice flow rate is attributed entirely to the shear deformation of a 1-m-thick layer of subglacial sediment (as opposed to shear deformation of the overlying ice column, which is the more likely case), the sediment flux into the lake is  $0.012 \text{ m}^3 \text{ s}^{-1}$  and the sediment filling time for the reservoir is 13 million years. Most glaciologists would view the assumed deformation rate and layer thickness to be wildly excessive, even as upper limits, and a maximum sediment filling time of the order to  $10^9$  years is probably more realistic.

An alternative mode of sediment transport is as suspended sediment in water flowing into the reservoir. For Lake Vostok the magnitude of this water discharge has been estimated as roughly  $1 \text{ m}^3 \text{ s}^{-1}$ , and most or all of this is attributed to roof melting rather than in-flow from the surroundings. If the flow was from the surroundings and the concentration of suspended sediment was 0.001 (by volume), the rate of sediment influx to the reservoir would be  $0.001 \text{ m}^3 \text{ s}^{-1}$ , giving a sediment filling time of roughly 150 million years. Higher concentrations of suspended sediment would be associated with episodic flood filling of the reservoir. This is an unlikely scenario for Lake Vostok, but it could apply to some Antarctic subglacial lakes.

### Sediments and Paleoclimatic Records

At present, the paleoclimate and ice sheet history of Antarctica is being assessed by the analysis of cores recovered at the edges of the continent because only a few boreholes have accessed the beds beneath the ice sheets (Figure 1.4). The sediment records contained in subglacial aquatic environments, however, may provide a much-needed detailed paleoenvironmental record from the interior of the ice sheet. It may be a challenge to decipher these records if the sediments contained in these subglacial aquatic environments are a mixture of materials that are deposited on different time scales or if the stratigraphic chronologies are disturbed or destroyed.

Geological proxies will have to be identified to decipher subglacial sedimentary processes within sediment cores to ensure that changes are recognized; methods must be developed to determine the maximum age of subglacial aquatic environments; and chronological methods are needed to date the sediments within these environments. Biological and chemical proxies will also have to be developed to help interpret the timing of paleoenvironmental and climate changes contained in the sedimentary records (SCAR SALE 2006).

If a mechanism exists for protecting the sediments from the overriding glacier—for example, the formation of perennially ice-sealed lakes such as those found in the McMurdo Dry Valleys (Doran et al. 2003, 2004),—the sediment records from subglacial lakes may provide an unparalleled record of Antarctic paleoenvironmental information, extending well beyond the limit of ice core records. Most subglacial lakes are relatively small and fairly shallow, but these shorter sediment records will provide valuable information about subglacial lakes. Longer records, however, may provide the key to understanding the origins of subglacial aquatic environments because this information may be at the bottom of sedimentary sequences (SCAR SALE 2006). Seismic data from Vostok Station (Popkov et al. 1998) indicate that approximately 300 m of sediments may be contained in the southern end of Lake Vostok. The lake sediments could contain a high-resolution record of conditions that existed before the continent was covered by ice.

The information in long sedimentary cores that may be recovered from deep environments such as Lake Vostok may provide a mechanism to constrain the preglacial to subglacial transition (SCAR SALE 2006). If we are to understand how life is expressed over time in these environments (SCAR SALE 2006), it will be important to assess whether these environments persist during both glacial and interglacial periods or whether they are unstable and drain, creating “cessation” events. These records may help fill gaps in the history of Antarctica’s interior and the evolution of ice sheets and help us understand the role that the Antarctic interior played in the glacial and

paleoclimatic history of the Antarctic continental margins and the Earth throughout the Cenozoic (65 million to 2 million years ago). From a biological standpoint, these cores may provide information about the response of microbiological systems to climate change and illuminate the telltale signs of microbial evolution in icy environments, which could be applicable to the search for life in the solar system (SCAR SALE 2006).

## GASES

Subglacial water is derived from glacial ice, which contains air trapped as the ice was being formed. As ice gets progressively buried, pressure in the ice increases proportional to the weight of the overburden. At depths of about ~1000 m, the trapped air and ice form a solid substance known as air clathrate hydrate. However, air hydrate is only stable in lakes below 1.5 km due the differences between its stability with respect to ice and bubbles and its stability with respect to water and dissolved gas (Lipenkov and Istomin 2001).

Results from the Vostok ice core show gas levels on the order of 0.8 to 1.0 L kg<sup>-1</sup> of ice in glacial ice above Lake Vostok and levels near zero in the accretion ice (Jouzel et al. 1999; Souchez et al. 2003). A possible explanation for this lack of gas is that it is excluded during accretion ice formation. Given a closed system where glacial ice forms subglacial meltwater and contributes its full gas load, while accretion ice excludes gases, we would expect gases to build in the lake over time. McKay et al. (2003) show that this buildup would create a hypercharged water column with respect to atmospheric gases. For lakes at depths less than 1.5 km, the gas pressure builds up to the hydrostatic pressure and further gas goes into bubbles. For lakes deeper than 1.5 km, clathrate forms and the dissolved gas levels off at a concentration of ~2.5 L of gas per kilogram of lake water regardless of depth (Figure 2.13). At this level, any further input of gas would accumulate as clathrate. By way of comparison, the gas concentration in an unopened can of soda is about 3 L kg<sup>-1</sup>, and the gas content of Lake Nyos, which in 1986 catastrophically degassed killing 1700 people, is 2-4 L kg<sup>-1</sup> (Kling et al. 1987). For Lake Vostok, the most significant impact of such a high gas pressure may be that this will create a hyperoxic environment, with oxygen levels ~50 times saturation (McKay et al. 2003).

Some subglacial lake sediments may contain air clathrate hydrates that provide a long-term record of atmospheric gas. As the glacier ice melts, air clathrate hydrate should remain stable. Air hydrate has an equilibrium density between 0.980 and 1.025 g cm<sup>-3</sup> (Uchida and Hondoh 2000), and Lake Vostok is estimated to have an average water density of 1.016 ± 0.001 g m cm<sup>-3</sup> (Wuest and Carmack 2000). Given these densities we would expect some hydrates to float and some to sink, but circulation may also cause hydrates to be kept in suspension (Lipenkov and Istomin 2001). If conditions are suitable, natural gas hydrates could also accumulate in situ.

The implications of potential high gas pressures on access to subglacial aquatic environments are largely dependent on the depth of the water body. Gas pressure cannot exceed hydrostatic pressure in subglacial lakes. However, if water is allowed to rise in a hole to depths shallower than 1500 m, or if lakes shallower than these depths are sampled, bubble formation can occur, potentially causing rapid degassing of these lakes.

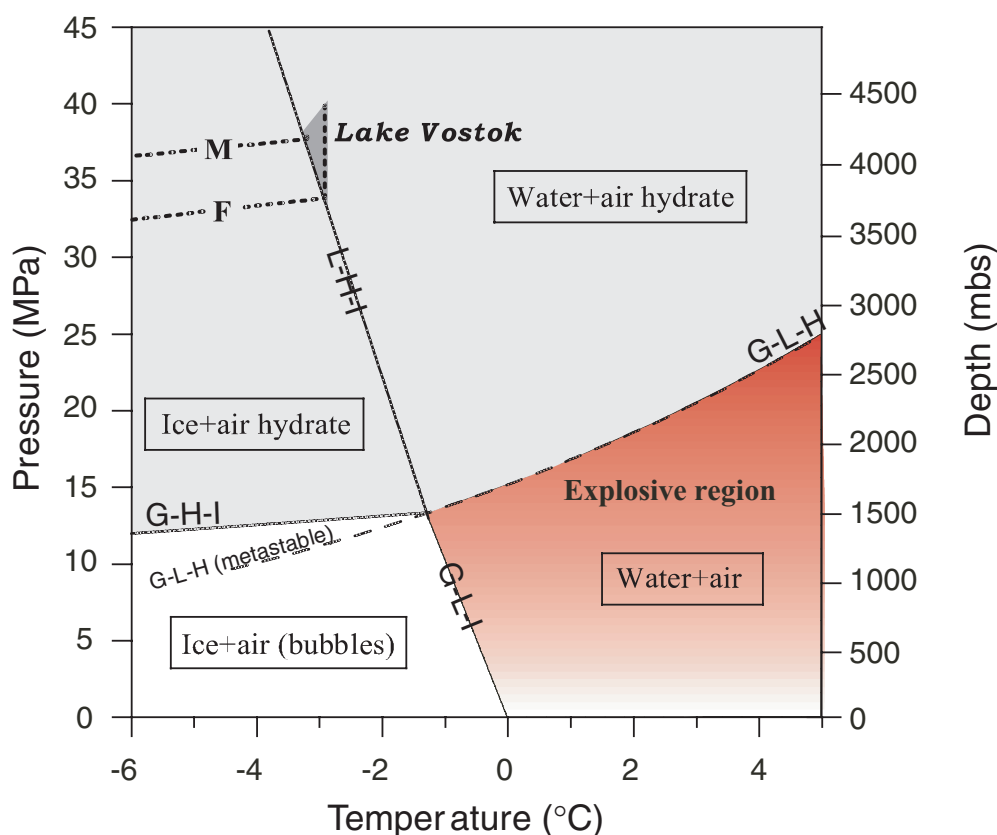

FIGURE 2.13 Phase diagram for air clathrate hydrate near 0°C. Dotted curves show the relations between temperature and pressure (depth) in the Antarctic ice sheet and sub-ice water at the reference sites M and F located in the zones of subglacial melting and freezing, respectively. Gray regions show fields of air hydrate stability. Small darkened triangle within this field covers the range of in situ conditions in Lake Vostok. The red shaded area is the area where if liquid water is present, explosive degassing could occur upon drilling into the water. Water from below allowed to rise into this zone could also explosively degas. The intensity of the red indicates the level of degassing risk. SOURCE: Lipenkov, V. Y. and Istomin, V. A., On the stability of air clathrate-hydrate crystals in subglacial Lake Vostok, Antarctica, *Materialy Glyatsiologicheskikh Issledovaniy*, 91: 138-149.

If Lake Vostok contains air clathrate hydrate in equilibrium with water, why are clathrates not found in the accretion ice? Based on laboratory studies, air clathrate has been found to have an equilibrium density between 980 and 1025 kg m<sup>-3</sup> depending on the cage filling (occupancy) and the gas composition (Uchida and Hondoh 2000). McKay et al. (2003) show theoretically how clathrate density could increase to 1080 kg m<sup>-3</sup> with a clathrate composition of 10 percent CO<sub>2</sub>. In comparison, Lake Vostok water density is 1018 kg m<sup>-3</sup> (Wuest and Carmack 2000), so we would expect

some clathrates to sink and others to float depending on gas composition. The absence of clathrates in the accretion ice may be related to a dominance of heavier clathrate through CO<sub>2</sub> incorporation (McKay et al. 2003) and/or floating clathrates not collecting in areas where accretion ice forms.

This discussion does not consider gases that may be accumulating in subglacial sediments since we know nothing about these environments. However, on a continent the size of Antarctica there are bound to be areas where, for example, methane hydrates accumulate. Methane hydrate has a relatively low density but accumulates on the ocean bottom attached to sediments. In the ocean, any methane hydrate allowed to float free will dissociate en route to the surface. In a subglacial lake, besides accumulating in the sediment, methane hydrate could also accumulate at the underside of the ice as long as the pressure-temperature state remains below dissociation limits. The dissociation pressure of methane clathrate is about 26 atmospheres and the clathrate would remain stable in Lake Vostok (Miller 1974).

It is the refreezing process, not bottom melting, that leads to concentration of atmospheric gases in subglacial water. In situations where there is melting but not refreezing, the gas concentration in subglacial water will approximate that of glacial ice and hyperconcentration is not an issue. For Lake Vostok, there is strong evidence that freeze-on is an important process (e.g., Jouzel et al. 1999; Siegert et al. 2000; Bell et al. 2002; Tikku et al. 2004), but it does not necessarily follow that gases are hyperconcentrated in the lake. If the lake behaves as an open hydrologic system, receiving water from an upstream catchment and spilling it continuously or episodically to a downstream flow network, the residence time for water in the lake could be short enough to minimize the concentrating effects of refreezing. At present there is no information on through-flow of water for Lake Vostok, so the parsimonious—though not necessarily correct—assumption is that through-flow can be neglected.

## CONCLUSIONS

The conditions of topographic slope that favor the formation of subglacial lakes are far more stringent than those that apply to subaerial lakes. Large lakes such as Lake Vostok lie in steep-sided physiographic basins that, unless recently formed, would have existed before the ice sheet and been even more effective as subaerial water traps. Thus, it is highly likely that large Antarctic subglacial lakes existed preglacially (some 35 million years ago) as subaerial lakes, that unless scoured during glaciation, should contain preglacial sediment. Continuous existence of these aquatic environments, from before the onset of glaciation to the present day, is much less likely than the presence of sediments. Seismic data have been used to estimate a 300-m thickness of sediments near Vostok Station. The lake sediments could contain an unparalleled record of Antarctic paleoenvironmental information, extending well beyond the limit of ice core records.

Most Antarctic subglacial lakes were detected by airborne radar sounding. The largest of these have a clear surface expression, while smaller lakes have a less obvious surface trace. A high-resolution digital elevation model, drawing on a variety of sources, has been produced for the entire ice sheet (Liu et al. 1999) and it seems very unlikely that any Vostok-sized lakes remain undiscovered.

Because of the dependence of ice melting temperature on pressure, the basal melting temperature under large areas of the ice sheet is at or below  $-2^{\circ}\text{C}$ . Much of the base of the Antarctic ice sheet is at the melting point, and for the ice sheet as a whole, net

basal melting exceeds net basal freezing. One result of basal melting is excess meltwater production beneath the ice sheet. Of necessity, a drainage system must form to transfer excess water from the ice sheet interior toward the periphery to regions of water storage or removal. Evidence for subglacial water discharge events comes from satellite detection of rapid (month- to year-scale) changes in the ice surface elevation of West Antarctic ice streams and above a known subglacial lake in central East Antarctica. Streams could form in meltwater channels that occur irregularly at the bottom of the ice sheet or could flow within layers of rocks or fractured bedrock that resemble the hyporheic flow paths beneath the beds of most rivers and streams. Most subglacial aquatic environments are likely to be part of an extensive subglacial drainage system rather than being hydrologically isolated. The flow of subglacial water is guided by the topography of the ice sheet surface and, to a lesser extent, the topography of the subglacial bed; together these topographic influences subdivide the Antarctic ice sheet into discrete drainage basins. Although the subglacial water system is likely to be interconnected, either continuously or sporadically, not every part of the water system is connected to every other part. The most plausible conclusion is that subglacial aquatic environments are simply one component of a subglacial drainage system that is organized into hydrologic catchments, analogous to those that occur subaerially. However, a basin-scale analysis of hydrologic catchments is necessary before lake-to-lake interactions can be critically examined.

The circulation of subglacial lakes is driven by small gradients in the potential energy of lake water that can result from vertical or lateral gradients in water density. This density depends on the pressure, temperature, and salinity of water. Of the three density dependents, the salinity of the subglacial aquatic environments is least constrained. Measurements of Vostok accretion ice and modeling results provide evidence for low-salinity lake water. However, if one temperature extrapolation is correct, higher-salinity water is inferred because increased salinity depresses the temperature of freezing. The low-salinity hypothesis also raises questions about the residence time of lake water and how low salinity can be maintained. The question of the salinity of subglacial lakes has not yet been answered definitively.

An important contribution to the circulation of Lake Vostok is associated with the sloping ice ceiling of the lake. Although the ceiling slope is not great, it would be much less if ice flow were aligned with the long axis of the lake. For many subglacial lakes, the ceiling may be nearly flat and this contribution to lake circulation could become small or negligible.

Glacial ice is formed by compression of surface snowfall. During the transformation from snow to ice, air trapped in the snow pack becomes entombed as bubbles within solid ice. As the depth of burial increases, these bubbles disappear and atmospheric gases are stored in solid form as air hydrates. The concentration of air in Antarctic glacial ice is estimated at  $90 \text{ cm}^3$  (at standard temperature and pressure [STP]) per kilogram of ice (McKay 2003); this concentration of air far exceeds the concentration of air-saturated water under the same conditions. Thus, subglacial meltwater is more highly concentrated in the dominant air gases ( $\text{N}_2$  and  $\text{O}_2$ ) than subaerial water. Freezing of meltwater concentrates chemical impurities in the liquid phase and, in subglacial lakes, could result in hyperconcentration of gases such as oxygen. It is not clear whether microbes are affected by these high concentrations. Chemically, subglacial aquatic environments can be expected to vary widely from site to site, and the complete

absence of viable microbes cannot be excluded. Extreme oligotrophic environments are themselves unusual and scientifically interesting.

Ice at the base of the Antarctic ice sheet is not older than 1-2 million years. Thus the maximum separation time between ice deposited at the surface as snowfall and ice melting at the base of the ice sheet is 2 million years. Microbes deposited at the surface of the ice sheet 1-2 million years in the past are, at present, inoculating the subglacial aquatic environment. These aquatic systems are likely to contain materials, derived from the ice and possibly from bedrock and preglacial sediments that, despite the high pressure and low temperature, would allow slow growth of some microbes. A full discussion of the potential biological environment is presented in Chapter 3.

There is considerable uncertainty in the values of the coefficients that govern the partitioning of chemical and biological constituents of subglacial aquatic environments during freeze-on of ice accreting at the bottom of the ice sheet. This uncertainty makes it challenging to determine the chemical and microbial concentrations of water by analyzing chemical and microbial concentrations in ice accreted at the lake surface.

It is possible that contaminants will be introduced into subglacial aquatic environments during exploration and sampling. If these environments constitute a subglacial drainage system that is organized into hydrologic catchments, then potential downstream impacts must be taken into account; contamination introduced near the headwaters of a drainage system will have greater impact than the same level of contamination at sites farther downstream. However, the volume associated with each subglacial environment and the decreased residence times that result from subglacial connectivity may help reduce the impact of contamination.



## 3

## Subglacial Environments: Biological Features

### INTRODUCTION

To develop a research and management plan for subglacial aquatic environments, one of the principal issues that needs to be resolved is whether these systems contain viable organisms. In the case of microbes, viable means only that they are capable of growth, and it is possible that subglacial environments contain viable but not actively growing microbes. If there are actively growing microbes in subglacial aquatic environments, this will dictate that a specific course of action be taken during the exploration and studies of such environments to ensure that these ecosystems are not profoundly changed or irreversibly altered. While no subglacial aquatic environments have been sampled directly to date, a general understanding of some of the key physiochemical characteristics of these environments has developed (Siegert et al. 2003; Christner et al. 2006). The key questions that need to be addressed are the following: (1) Can these environments support cell maintenance and growth (Box 3.1) and thereby be considered active systems? (2) What are the likely source populations? (3) Have the populations evolved to be significantly different from their source.

### REQUIREMENTS FOR LIFE

The minimum requirements for proliferation of microorganisms are an inoculum of viable cells; available water; electron donors and acceptors for biological energy supply (Box 3.1); a source of carbon, nitrogen, phosphorus, sulfur, iron, and other elemental constituents of biomolecules; sufficient time for reproduction; and the absence of severe physical, chemical, or biological conditions that would destroy cells or preclude growth. Severe conditions may include extremes in temperature, pH, pressure, water activity, salinity, and the presence of ionizing radiation. It should be noted, however, that to date, in terms of the extent of microbial life, no geographic limitations are known. Evidence of microbial life has been found in the most extreme environments. These environments include submarine hydrothermal vents (Baumgartner 2002; Kashefi and Lovley 2003), terrestrial hot springs (Brock 1997;

---

### BOX 3.1 Biological Energy Supply

All life uses adenosine triphosphate (ATP) for storing energy and driving cellular processes that require energy (such as flagellar rotation or protein synthesis). Therefore sufficient free energy must be biologically available (e.g., in the form of redox couples) and exceed a finite minimum in order to drive the formation of ATP from adenosine diphosphate (ADP). The presence of free energy in an ecosystem that equals or exceeds this finite minimum is necessary to sustain life and conserve ecosystem functions (Hoehler 2004; von Stockar et al. 2005). From a thermodynamic standpoint it is not possible to couple with complete efficiency all energy released during metabolism to ATP synthesis. The thermodynamic efficiency of the ecosystem must therefore account for the proportion of free energy of metabolism that can be captured and stored along with that proportion lost as heat (Hoehler 2004; von Stockar et al. 2005). Thus, the minimum free energy that must be available for biological processes in any given environment is the combination of the ATP synthesis energy, stoichiometry of ion release during ATP synthesis, and thermodynamic efficiency (Schink and Stams 2002). This quantity can be referred to as the biological energy quantum (BEQ) and provides a predictive measure of the favorability of biological activity analogous to the use of Gibbs free energy change to determine the likelihood of a chemical reaction proceeding (Hoehler 2004).

Coupled to the presence of an energy quantum that must be generated in a chemical reaction inside a biological system is the concept of maintenance energy (ME), which suggests that organisms require a certain minimum rate of energy intake to maintain molecular and cellular order and function (Hoehler 2004). Three levels of increasing ME requirement can be described (Morita 1997): (1) cell survival, (2) cell maintenance, and (3) active cell growth. Both BEQ and ME can be affected by a variety of environmental factors such as temperature (BEQ and ME requirements should decrease with temperature). BEQ and ME requirements thus define the minimum substrate concentration and substrate generation rate that must be sustained by a given environment in order to support life (Hoehler 2004). For some time the figure of  $-20 \text{ kJ mol}^{-1}$  was described in the literature as the minimum quantum of free energy that could be converted by a biological system (Schink 1997). More recently, a free energy value as low as  $-4.5 \text{ kJ mol}^{-1}$  was reported (Jackson and McInerney 2002) to support growth of a co-culture of butyrate-degrading organisms with methanogens in which one species lives off the products of another. Although the ability to measure thermodynamic minima such as BEQ and ME is still very much a work in progress, this result implies that microbial communities could be supported even in extreme subglacial aquatic environments despite ultra-oligotrophic substrate concentrations and the absence of sunlight.

---

Rothschild and Mancinelli 2001), brine channels in sea ice (Thomas and Dieckmann 2002), glaciers and ice shelves (Christner et al. 2003; Mueller et al. 2005), the subterranean deep biosphere (Pedersen 1993), cold deep-sea environments (Yayanos 1995; Bartlett 2002), deserts (Drees et al. 2006), and pH and salinity extremes (Vreeland et al. 2000; Fütterer 2004).

Subglacial aquatic systems are extreme environments for microbial life with low temperatures, elevated pressures, and no direct contact with the atmosphere or sunlight. Indirect evidence suggests that they may also have a high gas content (including oxygen) and low inorganic and organic nutrient concentrations. Most temperate latitude species are unlikely to proliferate and are also unlikely to compete effectively with species

that have been selected for over long periods of time by this unusual combination of properties. However, Lake Vostok and other subglacial aquatic systems are liquid-water environments with a number of features that are conducive to microbial growth, and the growth of a small subset of contaminating cells cannot be precluded. Growth may be especially favored for those microbes that are introduced from viable populations in glacial ice higher in the borehole (Chapter 3) and within drilling fluids that contain both organic substrates and living cells (Chapter 4).

Persistent liquid water, stable conditions, and extended time for reproduction are features of subglacial aquatic environments that make them suitable habitats for microbial growth. In this respect they contrast with many polar environments that are subject to intense freeze-thaw cycles (e.g., shallow lakes and ponds, ice shelf ecosystems), physical disruption (e.g., sea ice), and extreme aridity (e.g., polar desert soils, rock surfaces).

### POTENTIAL IMPEDIMENTS TO LIFE IN SUBGLACIAL AQUATIC ENVIRONMENTS

Adverse conditions in the subglacial environment that could inhibit or preclude growth include low temperature, elevated pressure, and any reactive oxygen species favored by high oxygen tensions. Despite their extremely cold environments, many microbial species in the polar environment are psychrotolerant (able to grow at low temperatures) rather than psychrophilic (optimal growth at low temperatures). All of these microbes grow slowly under extremely cold conditions, yet they can sometimes achieve large standing stocks because losses are low (Vincent 2000). These include well-developed benthic microbial mats in polar lakes with ultra-oligotrophic water columns (Bonilla et al. 2005) and microbial communities in the anoxic sediments of Antarctic saline lakes (Mancuso et al. 1990). It is also well known that microbial communities grow in polar oceans at temperatures down to  $-1.8^{\circ}\text{C}$ , and can be sustained at much lower temperatures ( $-20^{\circ}\text{C}$ ) in cold saline environments such as the brine channels in sea ice (Junge et al. 2004).

The deep ocean habitat is similar to that of subglacial aquatic environments, being both high pressure and cold. Despite these two adverse conditions, microbes can live as deep as 10,000 m in the ocean (Parkes et al. 1994; Kormas et al. 2003), well above the pressures found in subglacial aquatic environments where they are less than or equal to 400 atmospheres, equivalent to 4000 m in the ocean. Supersaturated oxygen habitats are also known to harbor active microbial communities, including the perennially ice-covered lakes of the McMurdo Dry Valleys (Wharton et al. 1986). The upper waters of Lake Vostok, however, are predicted to contain extreme oxygen levels more than an order of magnitude higher. McKay et al. (2003) calculated that *in situ* gas concentrations in Lake Vostok would be up to 2.5 L per liter of lake water (at standard temperature and pressure), equivalent to  $750\text{ mg O}_2\text{ L}^{-1}$ . Even higher values (up to  $1300\text{ mg O}_2\text{ L}^{-1}$ ) have been estimated by Lipenkov and Istomin (2001).

These oxygen tensions could be a severe constraint on growth if accompanied by the formation of reactive oxygen species (see below), particularly for microbial contaminants that would largely comprise taxa that are adapted to less severe conditions. Resistant cells and endospores attached to particles might find more favorable oxygen conditions for proliferation as they sink deeper in the water column.

Information about the chemistry and microbiology of Lake Vostok is limited to exhaustive analysis of the accreted ice. As described earlier (Chapter 2), the accreted ice makes up the bottom 84 m of the ice core retrieved above Lake Vostok. Jouzel et al. (1999) observed that this ice extended from 3539 m below the surface of the Antarctic ice sheet to its bottom at about 3750 m and differed from the overlying glacial ice in isotopic properties, total gas content, crystal size, and electrical conductivity. They concluded that this section of the Vostok core consists of ice refrozen from Lake Vostok water.

Although the chemical composition of subglacial aquatic environments remains highly speculative, the analysis of glacial and accretion ice from Vostok implies that the elemental requirements for microbial growth could be satisfied in the lake and that there are many possible electron donors and acceptors for biological production by chemotrophic and heterotrophic organisms (Table 3.1).

However, the various measurements of these concentrations in Lake Vostok ice differ by orders of magnitude (De Angelis et al. 2004). This may reflect differences in protocols between laboratories or real differences associated with sampling a heterogeneous ice core (Price 2007). One suggestion that accounts for some of the heterogeneity (Bell et al. 2002) involves the movement of the ice across the lake. In this scenario, one level of the accretion ice in the ice core formed when that site in the ice sheet was above a shallow embayment; another level of accretion ice formed later when the site was above a deep pelagic part of the lake.

Additional substrates could enter the lake environment by glacial scour of the surrounding bedrock and the transfer of dissolved and particulate minerals by advection

TABLE 3.1 Possible Electron Donors and Acceptors in Subglacial Aquatic Environments in the Presence (Aerobic) or Absence (Anaerobic) of Oxygen

Conditions	Electron Donor	Electron Acceptor	Metabolic Process
Aerobic	H <sub>2</sub>	O <sub>2</sub>	H oxidation
	HS <sup>-</sup> , S <sup>0</sup> , S <sub>2</sub> O <sub>3</sub> <sup>2-</sup> , S <sub>4</sub> O <sub>6</sub> <sup>2-</sup>	O <sub>2</sub> , NO <sub>3</sub> <sup>-</sup>	S oxidation
	Fe <sup>2+</sup>	O <sub>2</sub>	Fe oxidation (low pH)
	Mn <sup>2+</sup>	O <sub>2</sub>	Mn oxidation
	NH <sub>4</sub> <sup>+</sup> , NO <sub>2</sub> <sup>-</sup>	O <sub>2</sub>	Nitrification
	CH <sub>4</sub> and other C-1s	O <sub>2</sub>	(C-1) oxidation
	CH <sub>4</sub>	O <sub>2</sub>	Methane oxidation
	Organic compounds	O <sub>2</sub>	Heterotrophic metabolism
Anaerobic	H <sub>2</sub>	NO <sub>3</sub> <sup>-</sup>	H oxidation
	H <sub>2</sub>	S <sup>0</sup> , SO <sub>4</sub> <sup>2-</sup>	S <sup>0</sup> and sulfate reduction
	H <sub>2</sub>	CO <sub>2</sub>	Acetogenesis
	H <sub>2</sub>	CO <sub>2</sub>	Methanogenesis
	S <sup>0</sup> , SO <sub>4</sub> <sup>2-</sup>	NO <sub>3</sub> <sup>-</sup>	Denitrification (inorganic)
	Organic compounds	NO <sub>3</sub> <sup>-</sup>	Denitrification (organic)
	Organic compounds	S <sup>0</sup> , SO <sub>4</sub> <sup>2-</sup>	S <sup>0</sup> and sulfate reduction
	Organic compounds		Fermentation

SOURCE: Modified from Siegert et al. (2003).

directly or after melting of the bottom ice. Such inputs could include mineral particles of the type seen in the upper accretion ice of Lake Vostok that are thought to be derived from the shore of the lake. Microbial growth on substrates in glacial rock flour, such as metal sulfides, has been documented in suboxic and anoxic glacial bed environments (Christner et al. 2006); for example, microbial production has been suggested for an ecosystem contained within the basal ice of the Greenland Ice Sheet. Here, the lower 13 m of the GISP2 (Greenland Ice Sheet Project) ice core (at a depth of 3053 m) contains high concentrations of bacteria ( $>10^8$  cells  $\text{cm}^{-3}$ ) attached to abundant clay particles; Tung et al. (2006) suggest that these bacteria thrive by reduction of Fe(III) within the clay, in the process oxidizing organic molecules such as phenol and humic acids (both detected in the ice) to  $\text{CO}_2$ . The chemical properties of this interface, however, reflect the freeze-over of an anaerobic wetland and are likely to differ greatly from subglacial environments in Antarctica.

In addition, some subglacial aquatic environments (e.g., Lake Vostok) may have formed as aerial lakes at a time prior to the cooling of Antarctica. Formation of lakes in this manner would provide early sources of sediments that could harbor carbon and nutrients that subsequently could continue to be recycled within the resulting subaerial system. Other characteristics of subglacial aquatic environments that may contribute potential sources of carbon and energy to support microbial life include tectonic activity, the presence of hydrothermal vents, gas hydrate deposits, and cold seeps containing inorganic solutes.

Microbial communities growing in the interface between ice and rock could also provide a source of biota and organic carbon into the lake. The detection of thermophiles (Table 3.2) in a clone library analysis of samples of Vostok accretion ice (Bulat et al. 2004) has led to speculation about the possibility of hydrothermal vents and an ecosystem based on chemolithotrophy by heat-loving microbes. Bulat et al. (2006) have recently suggested that fault vents and microbial ecosystems are likely to be in a shallow side basin or outside the lake, with horizontal transfer of microbiota to the 5G borehole site by the overlake ice flow. It is likely that such bacteria may not survive in the frigid waters of Vostok, but perhaps could provide an allochthonous (external) source of organic carbon to the lake ecosystem.

Glacial meltwaters at latitude 80 degrees south contain relatively high concentrations of dissolved organic nitrogen and nitrate (Vincent and Howard-Williams 1994), suggesting long-range and upper atmosphere input mechanisms that could deliver reduced and oxidized nitrogen compounds into subglacial aquatic environments via their overlying ice. Nitrification has been identified as one potential mechanism for energy supply in subglacial systems (Table 3.1), with potential ammonium levels of  $3 \mu\text{g L}^{-1}$  in meltwaters from the glacial ice (Siegert et al. 2003). The nitrification intermediate  $\text{N}_2\text{O}$  has been detected in the Vostok ice column, and experiments to date with the psychrophilic nitrifier *Nitrosomonas cryotolerans* show that nitrification could occur down to at least minus  $12^\circ\text{C}$  (Sowers et al. 2006).

Measured dissolved organic carbon (DOC) concentrations in the accretion ice of Lake Vostok vary greatly, from undetectable to around  $80 \mu\text{mol L}^{-1}$ . In part this may reflect vertical heterogeneity in the ice column but it may also result from major differences in DOC analytical methodologies among laboratories. Further uncertainty surrounds the appropriate partition coefficient for the distribution of solutes between ice and lake water during freeze-up (Siegert et al. 2003). It is also known that this partitioning acts differentially, with higher-molecular-weight organic compounds excluded

TABLE 3.2 Taxonomic Identification of Clone LV3607bR-40A Recovered from Accreted Ice Sample at a Depth of 3607 m

Closest Neighbors and Their Features						
GenBank <sup>d</sup> (similarity, %)	Acc. No.	Representative	Sampling Site	Temperature Profile (°C)	Source	References
100	AB009828	<i>Hydrogenophilus thermoluteolus</i> TH-1	Hot springs, Izu district, Japan	52 <sup>b</sup>	Crustal fluid, adjacent soil	Gogo et al. 1977 Hayashi et al. 1999
99.5	AJ131694	<i>Hydrogenophilus hirschii</i> yel5a	Angel Terrace Spring, Yellowstone National Park, USA	50-67	Crustal fluid	Stohr et al. 2001
99.1	AB009829	<i>Hydrogenophilus thermoluteolus</i> TH-4	Hot springs, Izu district, Japan	50 <sup>b</sup>	Crustal fluid, adjacent soil	Gogo et al. 1977 Hayashi et al. 1999
96.3	AF026979	Unidentified beta-proteobacterium OPB30 (rDNA study only)	Obsidian Pool, Yellowstone National Park, USA	75-95	Sediments	Hugenholtz et al. 1998

<sup>a</sup>Only long, published 16S rDNA sequences are included in the analysis.

<sup>b</sup>Temperature profile for culturing.

SOURCE: Copied from Bulat et al. 2004.

to a greater extent than smaller organic molecules (Belzile et al. 2002). On the basis of ice-water partitioning measured in Antarctic Lake Bonney, Christner et al. (2006) calculated that Lake Vostok may contain 17-250  $\mu\text{mol L}^{-1}$  organic carbon, which may be sufficient to sustain microbial populations if continually replenished.

### Oxygen Effects

The surface waters of Lake Vostok are inferred to be supersaturated in oxygen given that ice melting into the lake contains air clathrate hydrates while the accretion ice formed during freeze-up of the lake water is gas-free. McKay et al. (2003) estimated that for a water residence time of 13,300 years, this pumping mechanism would result in oxygen tensions about 50 times higher than those found in surface lake waters in equilibrium with the atmosphere. These hyperbaric concentrations would likely have toxic and potentially lethal effects on many species of microbes if they were associated

with the formation of reactive oxygen species (ROS), but such effects have yet to be evaluated.

Molecular oxygen itself is relatively unreactive, and biomolecules such as proteins and nucleic acids are little affected by high oxygen tensions. However in the presence of ionizing radiation or after reaction with certain compounds, molecular oxygen is converted to ROS. In the cellular environment, oxygen reacts with reduced flavins (a constituent of redox enzymes) to produce superoxide and hydrogen peroxide. The latter can react with free iron to generate hydroxyl radicals. All of these products are stronger oxidants than oxygen itself and can have wide-ranging damaging effects on nucleic acids, proteins, and membrane constituents (Imlay 2002). These oxidative stress effects have been widely studied, including in laboratory or environmental systems during complete darkness (e.g., Bechtold et al. 2004).

Microorganisms have several lines of defense that can protect them from the damaging effects of ROS production (Sies 1997). These include the production of non-enzymatic antioxidants, such as tocopherol and carotenoids, and powerful enzymatic systems that react with and detoxify oxidants, in particular superoxide dismutases, catalases, and glutathione peroxidases. The effects of high oxygen tensions and ROS production on microbial metabolism and growth are therefore highly variable among species. For example, a 90-minute exposure of hyperbaric hyperoxia (100 percent O<sub>2</sub> at 2 atmospheres) inhibited growth of *Staphylococcus aureus* by 3-25 percent, but had no effect on the growth of *Escherichia coli* (Tsuneyoshi et al. 2001). It has also long been known from medical experience that even obligate anaerobes vary greatly in their oxygen sensitivity (Tally et al. 1975).

It should also be noted that subglacial aquatic environments may include those in which anoxic conditions or low oxygen tensions prevail, and where even O<sub>2</sub>-sensitive microbes may survive and grow. Aquatic environments that are flushed by hydraulic through-flow may not accumulate high oxygen concentrations, depending on the source waters. Aquatic environments may be stratified as in the perennially ice-covered lakes of the McMurdo Dry Valleys. These have supersaturated oxygen concentrations in their upper water columns, but also contain anoxic bottom waters and sediments. Particles in suspension in the water column may also provide interior microhabitats in which oxygen concentrations are much lower than in the surrounding water.

## SOURCE POPULATIONS

### Bacterial Transport

Biogeography is the study of the distribution of biodiversity over space and time and the mechanisms that generate and sustain this diversity, which include speciation, extinction, dispersion, and species interactions (Martiny et al. 2006). As described by Fenchel (2003), many macroscopic animal and plant species exhibit biogeographic patterns resulting from their limited distribution ranges on Earth due to requirements for specific habitats and climates as well as the influence of historical events (e.g., continent separations). These occurrences have combined to produce taxonomic groups that have evolved over the course of geologic time within continents or geographically isolated regions such as lakes, mountain ranges, or oceanic islands. These barriers to migration have resulted in the presence of groups restricted to specific locations (Fenchel 2003).

The existence of biogeographic patterns in microbes on the other hand is possible but not easy to identify (reviewed in Bell et al. 2005; Martiny et al. 2006). This uncertainty is due to a lack of information in many critical areas. For example, universal concepts that define a bacterial species are lacking (Box 3.2) and only now are methods being developed that are sensitive enough to resolve differences between microbes. However, some concepts of biogeography from studies in macroecology may be applicable to microbial ecological investigations, although at least some differences in biogeographical concepts are likely to exist between the two. For instance, Fenchel (2003) notes that microbial population sizes are enormous by comparison with macroorganisms and argues that microbial distribution can best be understood in terms of habitat characteristics. Furthermore, the probability of microbial dispersal is higher and the probability of local extinction is much lower in microbes than in macroorganisms. The effect and relative influence of historical contingencies on the existence of microbial biogeographic patterns also continue to be discussed (Martiny et al. 2006).

Many potential mechanisms exist for bacterial dispersion. For example, it has been calculated that about  $10^{18}$  viable microbes annually are transported through the atmosphere between continents (Griffin et al. 2002). Other evidence concerning particle transport by air currents comes from the record of volcanic ash described by Basile et al. (2001). These authors report, "There is a record of 15 ash layers in the past 500,000 years in the Vostok ice core. Nine layers originate from activity of the South Sandwich volcanic arc, three from southern South America, one from the Antarctic Peninsula (Bransfield Strait), and one from West Antarctica (Marie Byrd Land province). In spite of the low frequency of occurrence of visible tephra layers in the Vostok core (one event every 20 kyr [thousand years]), the overall atmospheric pathway of these ash events appears consistent with the almost continuous advection of continental dust from South America."

Movement by global ocean currents is another mechanism by which microbes can be transported long distances. Additional mechanisms include transport by birds and by the increasing presence and activity of humans in Antarctica. Of particular importance to the study of subglacial aquatic environments is their potential connectivity, which may allow the movement of microbes beneath the ice sheet. The surface of the Antarctic ice sheet acts as vast collector for microbiota deposited from the atmosphere (Vincent 1988), and a subset of this microflora may retain viability and even metabolize within the snow and glacial ice (Price and Sowers 2004; Price 2007). These communities of viable cells and spores may ultimately reach the subglacial aquatic environments to provide a continuous inoculum at the melting glacier ice-lake water interface.

Microscopic and culture analyses of Vostok glacial ice from the 1500-2750 m stratum (>240,000 years old) have shown the presence of a wide variety of microorganisms: bacteria (including actinomycetes), yeasts, fungi, and microalgae (Abyzov 1993; Abyzov et al. 1998), although questions remain concerning the presence of contaminants introduced during sampling. However, Abyzov (1993) points out that in the deepest ice he examined (2405 m) only spore-forming bacteria remained. As shown in Figure 3.1, the numbers of small cells containing DNA is higher in the glacial ice than in the accreted ice. Abyzov (1993, p. 284) had the following to say about the microbes he isolated from the Vostok ice core down to a depth of 651 m: "Psychrotolerant and psychrophilic microorganisms could be brought into the central parts of the Antarctic continent with the air flows from sub-Antarctic islands, littoral zones of the continent, or its ice-free area, but it cannot be excluded that mesophilic strains isolated from the



---

### BOX 3.2 Bacterial Speciation Processes

The definition of a bacterial species remains an elusive concept in microbiology in large part due to the fact that bacteria are clonal and reproduce asexually. As a result, the Biological Species Concept first espoused by Ernst Mayr (1942), which broadly states that groups of actual or potentially interbreeding natural populations can reproduce only among themselves to the exclusion of all others, is not applicable. At present, somewhat arbitrary operational definitions based on phenotypic characterizations (Bochner 1989; Mauchline and Keevil 1991) and molecular biological tools such as the association of genomic DNA in standardized DNA/DNA hybridizations (typically >70 percent) and/or gene sequence identity of  $\geq 97$  percent for the 16S ribosomal RNA (rRNA), are most commonly used to define bacterial species (Wayne et al. 1987; Stackebrandt and Goebel 1994; Konstantinidis and Tiedje 2005). The ever-increasing amount of information derived from comparative genomic analyses is providing fundamentally new insights into the question of what constitutes a bacterial species while further revealing that bacterial genomes are not static entities; many mechanisms or combinations thereof can contribute to both maintenance and change of genome structure and content over time (Ward and Fraser 2005). Among the most important forces contributing to the evolution of bacterial species are the interplay between the rates of mutation and homologous recombination (where homologous in this case denotes a substitution of some portion of a genomic sequence with a sequence of high similarity) and the influence of biogeography in the divergence of bacterial lineages through adaptations and separation into ecological niches (Nesbø et al. 2006).

Genetic variations are the source upon which evolutionary forces such as genetic drift and natural selection act. Some mutations in DNA are spontaneous, random events that can result from several possibilities. For instance, mutations can arise by the exposure of DNA to ionizing radiation, ultraviolet radiation, and some chemicals. Normally DNA sequences are copied precisely during replication; however, errors in DNA replication can result in changes in gene sequence. In addition, a variety of recombinatory processes can occur in nature that contribute to genetic variability by joining DNA from different biological sources (Graur and Li 2000).

Basic concepts of population genetics suggest that most mutations are deleterious to the fitness of an individual (ability of the individual to survive and reproduce) and are selected against causing their removal from the population, a process referred to as negative or purifying selection. Mutations can also result in alleles (alternative forms of the gene) of similar fitness that are considered neutral mutations and are subject to loss from or fixation within a population as a result of stochastic forces. Occasionally, a mutation may produce an allele that increases the fitness of an individual. These advantageous mutations will be subjected to positive selection and will tend to be fixed more rapidly in a population than to neutral mutations (Graur and Li 2000).

---

ice sheet originated from the islands and continents of the temperate latitudes of the Southern Hemisphere.”

### EVOLUTION OF LIFE IN SUBGLACIAL AQUATIC ENVIRONMENTS

Antarctic subglacial aquatic environments represent potentially rich and largely unexplored storehouses of genetic information. As such, a variety of biogeochemical processes could potentially be at work, resulting in unique metabolically active microbial assemblages in terms of structure and function. The age of the oldest ice in the ice sheet is 1 million years (EPICA 2004; Peplow 2006), and this has been taken to indicate the length of time of microbial isolation of Lake Vostok. Although 1 million years is not a considerable amount in terms of prokaryotic evolution, some changes

Homologous recombination is recognized as a vital process to maintain chromosome integrity by facilitating the repair of damaged DNA that is mediated largely through pathways controlled by the enzyme RecA (Ivanic-Bacce et al. 2006). However, homologous recombination is also increasingly being recognized as central to the creation of genetic variability and as an important force in genome change within and between prokaryotic lineages (Fraser et al. 2007). Within prokaryotic lineages, sources of change can result from rearrangement, duplication, or loss of chromosomal segments during DNA replication. Further recombination facilitates the exchange of DNA between lineages from a donor to a recipient, a process referred to as horizontal or lateral gene transfer (Ochman et al. 2000). Among the best-identified mechanisms of lateral gene transfer are those of transformation, conjugation, and transduction. Conjugation and transduction require an intermediary to genetic exchange, a plasmid in the case of conjugation and a bacteriophage or bacterial virus in the case of transduction. Alternatively, transformation, the third mechanism, involves the uptake of free DNA from the environment (Graur and Li 2000). Recombination is not restricted to the transfer of homologous DNA from a donor to a recipient in bacteria. One possible result of recombinatorial events is the integration of heterologous DNA from the donor to the recipient along with flanking homologous DNA. Therefore, under some circumstances DNA from distantly related lineages can also be transferred. Additional mechanisms that can facilitate this type of integration include transposable elements, such as insertion sequences, transposons, and retroelements (Bennet 2004). Site-specific recombination systems such as integrons (reviewed in Mazel 2006) have also been recognized as important mobile elements in acquiring exogenous genes and shaping genome change.

In mammalian reproduction, recombination accompanies each reproductive event. The rate of recombination in bacteria does not approach this frequency (Levin and Bergstrom 2000). However, it is possible that bacterial recombination can exceed mutation as a source of genetic variability, raising the possibility that at least a modified form of the Biological Species Concept may be applicable to some bacteria under certain circumstances. For example, related bacterial lineages may share a core set of genes via recombination in a common gene pool (Doolittle and Papke 2006).

At present there are a number of competing ideas concerning how mechanisms that foster genetic variability and the forces of evolution interact to both maintain sufficient genetic similarity (effectively preserving species) and to create genetic divergence between species. Currently an intense debate reigns as to the relative importance of barriers to genetic exchange by homologous recombination, which is broadly captured by two models: “the bacterial species model” (Doolittle and Papke 2006; Nesbø et al. 2006) **versus natural selection of adaptive mutants that use similar resources and inhabit similar physical locations (“the ecotype model”)** (Cohan 2002). As the search proceeds, to unlock the underlying principles that define a bacterial species will require the continued integration of results from diverse areas of biology. The exploration of subglacial aquatic environments will provide a unique lens through which to view and study these questions.

may have occurred to help these organisms adapt to the cold, dark, oligotrophic environment (Tiedje 1989).

The waters of Lake Vostok have been isolated from direct atmospheric contact for at least 15 million years (Christner et al. 2006), giving a much longer time for evolutionary processes to operate (Box 3.3), and the founding populations in the lake may even be older if the original microbiota were derived from Antarctic bedrock or sediments. Then they could have been isolated from the surface microbial populations prior to the formation of Lake Vostok, as much as 35 million to 40 million years ago (Tiedje 1999).

As discussed by Tiedje (1999), studies on the rate of genetic change of microbes in nature indicate that speciation could take 10 million to 100 million years. An often cited estimate of speciation is the divergence of *Escherichia coli* and *Salmonella enterica*

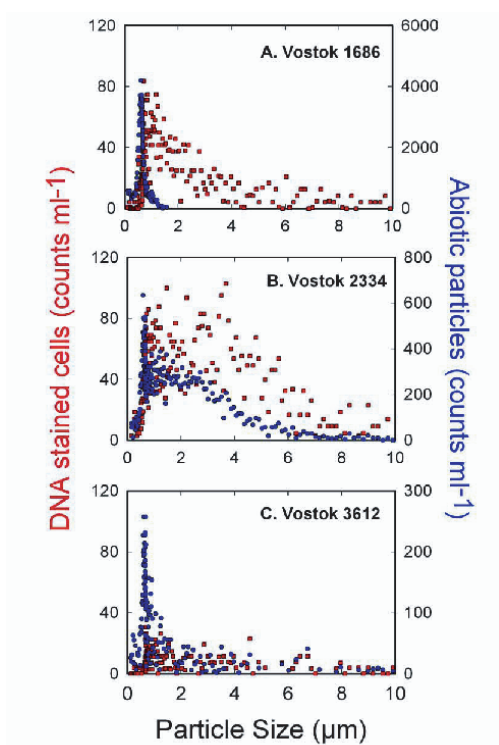

FIGURE 3.1 Flow cytometer data showing the relative abundance and size distribution of cellular and abiotic particles in Lake Vostok glacial ice (A = 1686 m; B = 2334 m) and accretion ice (C = 3612 m). Cellular particles were characterized by their fluorescence induced with the DNA stain CYTO 60. The presence of attached bacteria is also supported by the flow cytometer data in this figure. Note the rather scattered and large size of DNA containing particles. Using epifluorescence microscopy, these “large” cells are actually multiple cells aggregated on abiotic particles. SOURCE: From Priscu et al. (in press).

lineages from one another, which is estimated to have occurred approximately 100 million years ago (Lawrence and Ochman 1998). A division rate of 10 generations per year would give rise to a change of only one base pair per gene in 1 million years for a gene with 1000 base pairs (Tiedje 1999). If the microbes have been isolated from the surface microbes in bedrock or sediments for 35 million to 40 million years, significant genetic changes may have taken place. Tiedje (1999) points out that isolation of microbes in bedrock or sediments for millions of years also occurs elsewhere on Earth.

While speciation is not a well understood process (Box 3.2), lower rates of metabolic activity and growth may lengthen the time between bacterial generations, which will further increase the amount of time needed for significant genetic changes in genomes to take place. Further, connectivity of subglacial aquatic environments (Chapter 2) will serve to lessen genetic isolation and barriers to gene flow, although it may serve to increase the effective population for recombination (Fraser et al. 2007). Given

---

### **BOX 3.3**

#### **Natural Selection and Genetic Drift**

Evolution represents the process of change in the genetic content of populations. As such, the common denominator of evolution is the change in gene frequencies with time. Changes in allele (alternative forms of a gene) frequency can occur as a result of natural selection or genetic drift. Natural selection is the process by which organisms possessing the most favorable genetic adaptations outcompete other organisms in a population, resulting in their tendency to displace the less-adapted ones. Natural selection is dependent on the existence of variations of the same trait that confer different survival advantages or disadvantages (Graur and Li 2000). In contrast, genetic drift is a stochastic process by which changes in gene frequencies result from the accumulation of small, random, neutral mutations over time (Kimura 1983, 1989).

The forces of genetic drift and natural selection rarely act in isolation, and their relative strengths depend on several factors including effective population size. In large populations, genetic drift will occur slowly. Therefore even weak selection of an allele can have significant effects on its frequency; beneficial alleles will increase (positive selection), while harmful ones will be eliminated (negative or purifying selection) (Graur and Li 2000).

However, in species with a small effective population size, genetic drift will predominate. In small effective populations, deleterious alleles can increase in frequency leading to fixation in a population purely as a result of chance since the relative importance of genetic drift is greater. Species with a small effective population size are also subject to a greater probability of extinction because they are more vulnerable to genetic drift, leading to stochastic variation in their gene pool, demography, and environment. Any allele, regardless of its effect on fitness (deleterious, beneficial, or neutral), is more likely to be lost from a small population or gene pool than from a large one, resulting in a reduction in the number of variants of a given allele (Graur and Li 2000).

---

at most, millions of years during which evolutionary forces will have been at work, the metabolically active and growing microorganisms present in these communities should represent those better adapted to the relevant conditions but will still be related to microorganisms found in other environments today.

Is it possible to detect the end product of evolutionary change in subglacial environments? Many microbes may be present as viable cells that remain dormant until they encounter conditions that allow their metabolism and growth, as described by the “rare biosphere” concept (Pedrós-Alió 2007). These rare components would be undetectable with standard clone library analysis. However, emerging new technologies (Church 2006; Sogin et al. 2006) may increase the number of rare genotypes by several orders of magnitude or more.

### **CURRENT EVIDENCE FOR LIFE IN SUBGLACIAL AQUATIC ENVIRONMENTS**

#### **Biogeochemical Evidence for an Active Bacterial Flora in Lake Vostok**

The total dissolved solids (TDS) in the lake water can be estimated by applying ice-water partition coefficients to the major ion concentrations in the accretion ice (Christner et al. 2006). These ice-water partition coefficients are assumed to be the same

as those calculated from the permanent ice cover and water column of Lake Bonney in the McMurdo Dry Valleys. In this way, Christner et al. (2006) estimated the TDS concentrations of water in the embayment and the main lake to be 34 and 1.5 mmol L<sup>-1</sup>, respectively. The former value is well above typical concentrations in temperate lakes. In the same way, the concentrations of non-purgeable organic carbon (NPOC), amino acids, and major ions can be estimated. In the 5G core the concentration of NPOC in the glacial ice ranged from 2 to 80 μmol L<sup>-1</sup>. In Lake Vostok, Christner et al. (2006) predicted that the NPOC concentrations would range from 17 to 250 μmol L<sup>-1</sup>. Total amino acids (dissolved free and combined amino acids plus protein) in glacial ice constituted 0.6-2 percent of the NPOC, while they made up 0.01 to 2 percent of NPOC in the accretion ice. Although there was a significant correlation between the NPOC and amino acid concentration in the accretion ice ( $r = 0.83$ ), no significant relationship existed between these parameters in the glacial ice ( $r = 0.015$ ).

From these data plus information on the acid-extractable amino acid concentrations, Christner et al. (2006) concluded the following: relative to the main body of the lake, the waters near the shoreline represent a source of amino acids. This, together with the cell density data, implies that this region has elevated rates of heterotrophic biological activity and associated amino acid transformations.

### Biological Evidence for an Active Bacterial Flora in Lake Vostok

Analysis of samples from the accretion ice of Lake Vostok by epifluorescence microscopy (Figure 3.2) and scanning electron microscopy has shown the presence of intact, DNA-containing cells; however there are conflicting reports on their concentrations. Christner et al. (2006) reported that the number of bacterial cells counted in accretion ice depths between 3539 and 3572 m ranged from  $98 \pm 18$  to  $430 \pm 23$  cells mL<sup>-1</sup>. These data overlap with the range 200 to 3000 cells mL<sup>-1</sup> reported for samples between 3541 and 3611 m (Karl et al. 1999; Priscu et al. 1999; Abyzov et al. 2001). Price (2007) notes that other reports indicate concentrations less than 10 cells mL<sup>-1</sup>, but suggests that these disparities may simply reflect sampling error if the microbes are located in veins between the large ice crystals. The bacterial abundance is two- to seven-fold higher in accretion ice than in the overlying glacial ice, implying that Lake Vostok is a source of bacterial carbon beneath the ice sheet. Scanning electron microscopy (Priscu et al. 1999) has shown that microbial cells are often associated with organic and inorganic particles.

When a sample of the accreted ice was melted, Karl et al. (1999) were able to measure <sup>14</sup>CO<sub>2</sub> produced from added <sup>14</sup>C-glucose over incubations of 2, 11, and 18 days. They were careful to state, however, that the laboratory results were of potential activity only and in situ rates might be much lower.

### Biological Evidence for Viability of the Bacterial Flora in Lake Vostok

Christner et al. (2006) report that differential cell staining revealed that the majority (75 to 99 percent) of cells in the accretion ice are potentially viable, which is comparable to the ~80 percent value reported by Miteva et al. (2004) from a single depth of “silty” basal ice in the Greenland GISP2 core. Positive rates of glucose respiration in four of the six samples tested by Christner et al. (2006) corroborated the presence of viable heterotrophic cells. When the respiration data were normal-

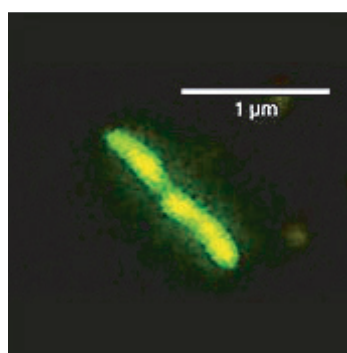

FIGURE 3.2 Bacterial sample from the Lake Vostok accretion ice analyzed by epifluorescence microscopy. SOURCE: Karl et al. (1999).

ized to the lake temperature of  $-3^{\circ}\text{C}$ , their measurements of glucose mineralization ( $0.005 \pm 0.003$  to  $0.2 \pm 0.005$   $\text{nmol C L}^{-1} \text{ day}^{-1}$ ) were on the low end of the range reported by Karl et al. (1999) for an accretion ice core from 3603 m ( $0.3 \pm 0.1$  to  $0.5 \pm 0.4$   $\text{nmol C L}^{-1} \text{ day}^{-1}$  at  $-3^{\circ}\text{C}$ ). However, Christner et al. (2006) found that in samples where respiration rates could be measured there were no significant levels of incorporation of substrate into macromolecules. On these same samples, Christner et al. (2006 p. 25) reported: “Our enrichment culturing studies on these samples have required up to 6 months of incubation in the dark at  $4^{\circ}\text{C}$  before growth is initiated (Arnold et al. 2005; Christner and Priscu unpublished). After this apparent period of resuscitation, the microbial (bacteria and yeast) species recovered and grew to visible densities on both liquid and agar-solidified media in  $<10$  d, and many of the isolates were capable of growth to the stationary phase in 40 h at  $22^{\circ}\text{C}$ . When non-growing and sub-lethally injured cells are placed in a growth situation (e.g., Dodd et al. 1997; Aldsworth et al. 1999), metabolism must first be initiated to repair incurred cellular damage before growth and reproduction can occur. Thus, if our incubations had been conducted over a longer time frame, we would expect such carbon-fed cells to eventually initiate the growth phase.”

### Evidence for an Autochthonous or Lake-Dwelling Microbial Flora

Microbiological and molecular-based studies of the accretion ice by six laboratories indicate that this ice contains low but detectable amounts of prokaryotic cells and DNA (Karl et al. 1999; Priscu et al. 1999; Abyzov et al. 2001; Christner et al. 2001; Bulat et al. 2004). Christner et al. (2006) state that molecular identification of microbes in Vostok accretion ice by culturing and small subunit rRNA gene amplification, show close agreement with present-day microbiota. These were identified to lie within the bacterial phyla Proteobacteria ( $\alpha$ ,  $\beta$ , and  $\gamma$ ), Firmicutes, Actinobacteria, and Bacteroidetes (Table 3.3). Further, they state (Christner et al. 2006; p. 2496): “Con-

TABLE 3.3 Microbial Diversity, Number of Cells, and Number of Inclusions Observed in Different Horizons of the Vostok 5G Deep Core Accretion Ice

Ice Depth (m below surface)	Region of the Accretion Ice Sampled	Inclusion Number (m <sup>-1</sup> ) (mean)	Investigator	Type of Microorganisms Detected	Total Numbers of Microorganisms Detected (cells /ml)
3541	Shallow embayment / grounding line (3540-3584 m)	0-5 (8.6)	Abyzov <sup>a</sup>	Micrococci, short rods, pollen, many diatoms	< 200
3555		15	Abyzov <sup>a</sup>	<i>Cytophaga</i> spp. and many Coccolithophoridae	600
3565		5-10	Abyzov <sup>a</sup>	<i>Caulobacter</i> spp.	250
3579		5-10	Abyzov <sup>a</sup>	Many micrococci, short rods, and Coccolithophoridae	100
3585		0-5	Abyzov <sup>a</sup>	<i>Cytophaga</i> spp.	250
3587		0-5	Sambrotto <sup>b</sup>	Fungi, rod-shaped bacteria, diatoms, pollen grains	Not quantified
3590		0-5	Priscu <sup>c</sup>	<i>Acidovorax</i> sp., <i>Comamonas</i> sp., <i>Afipia</i> sp., <i>Actinomyces</i> sp.	2800-36,000
3592		0-5	Abyzov <sup>a</sup>	Many different kinds	900
3593	Shallow open lake grounding line (3593-3608 m)	0-5 (4)	Christner <sup>d</sup>	<i>Brachybacterium</i> sp., <i>Paenibacillus</i> sp., <i>Methylobacterium</i> sp., <i>Sphingomonas</i> sp.	Not quantified
3598		5-10	Abyzov <sup>a</sup>	Many Coccolithophoridae	500
3603		5-10	Karl <sup>e</sup>	Gram-negative (?) rods, cocci, and vibrios	200-300
3606		5-10	Abyzov <sup>a</sup>	Many different kinds	700
3611	Open lake (3608-3623 m)	0 (0)	Abyzov <sup>a</sup>	Mostly diatoms and cyanobacteria	100
3619		0	Rogers and Bulat <sup>f</sup>	<i>Serratia liquefaciens</i> , <i>Comamonas acidovorans</i> , <i>Rhodoturla creatinovorans</i> , <i>Kocuria</i> sp., <i>Friedmanniella Antarctica</i> , <i>Hydrogenophlus theroluteolus</i>	Not quantified

<sup>a</sup>Data from Abyzov et al. (2005). Techniques used included light microscopy and scanning electron microscopy. Coccolithophoriade, cyanobacteria, actinobacteria, rod and coccus-shaped bacteria, and fungal conidia and hyphae were detected in all ice horizons examined.

<sup>b</sup>Data from Sambrotto and Burckle (2005). Techniques included culturing and microscopy.

<sup>c</sup>Data from Priscu et al. (1999). Techniques included microscopy and polymerase chain reaction (PCR) amplification.

<sup>d</sup>Data from Christner et al. (2005). Techniques included microscopy and PCR amplification.

<sup>e</sup>Data from Karl et al. (1999). Techniques included microscopy, flow cytometry, and <sup>14</sup>C uptake.

<sup>f</sup>Data from S.O. Rogers and S. Bulat, unpublished. Techniques included culturing and PCR amplification.

SOURCE: From Bell et al. (2005).

sidering that metabolic inferences for the  $\gamma$  and  $\delta$ -proteobacterial clones are based on distant phylogenetic relationships, confident predictions about physiology are unachievable. Although equivocal, the clustering of the identified small subunit rRNA gene sequences among aerobic and anaerobic species of bacteria with metabolisms dedicated to iron and sulfur respiration or oxidation implies that these metals play a role in the bioenergetics of microorganisms that occur in Lake Vostok.”

### Likelihood of Growth

Rates of proliferation of introduced as well as native microbes are likely to be greatly reduced in subglacial aquatic environments by the low ambient temperatures and high pressure conditions. Growth rates may be suppressed further by the inhibitory effects of high oxygen concentrations and by low concentrations of inorganic nutrients and organic carbon substrates.

Christner et al. (2006) applied Price and Sower's (2004) model to address the potential for survival, maintenance, and growth of microheterotrophs in Lake Vostok and concluded that carbon supply rates would be adequate for maintenance but not growth. It should be noted, however, that their upper estimate of in situ NPOC concentrations of  $250 \mu\text{mol L}^{-1}$  ( $3 \text{ mg C L}^{-1}$ ) greatly exceeds the total organic carbon in offshore marine environments of around  $75 \mu\text{mol L}^{-1}$  ( $0.9 \text{ mg L}^{-1}$ ).

Furthermore, organic carbon may vary among aquatic environments and spatially within aquatic environments and could achieve higher values than the estimates derived from Vostok accretion ice. For example, the organic carbon supply from melting ice and subglacial waters entering at the northern end of Lake Vostok could be higher than at the accretion ice end, more than 200 km away, particularly if there are organic inputs from active microbial processes at the ice sheet-rock interface. Many of the aquatic environments may be stratified and organic carbon levels could be higher in the bottom waters of each lake associated with microbial decomposition and release from the sediments.

Lake sediments typically contain orders of magnitude higher bacteria, nutrient, and DOC concentrations. The upward plumes associated with normal geothermal heating could potentially transport these constituents from the sediments to the upper water column in some aquatic environments. Subglacial lake sediments may also provide a microbial refuge from high oxygen concentrations in the overlying lake water.

Another of the interesting features of subglacial aquatic environments that distinguishes them from surface aquatic environments but is similar to deep marine environments is the absence of ultraviolet (UV) photochemistry. The exposure of natural surface waters to sunlight has multiple effects on DOC availability for microbial processes, including the photodegradation of higher-molecular-weight materials into more biologically reactive constituents, and the polymerization of certain autotroph-derived organic compounds into forms that are less available for microbial activity (Tranvik and Bertilsson 2001). This absence of UV effects will thus have both positive and negative implications for microbial growth in subglacial aquatic environments.

In summary, growth rates are unknown for bacteria in subglacial ecosystems, but they are likely to be slow and possibly negligible in some situations. Analogous systems include the deep seafloor biosphere where bacterial turnover times have been estimated as up to 22 years (Schippers et al. 2005). These slow rates of metabolism and growth also have implications for the extent of genetic adaptation to the subglacial



environment given that rates of evolution tend to be slow under conditions of low temperature (Gillooly et al. 2005) and low productivity (Horner-Devine et al. 2003).

## BIOLOGY—CONCLUSIONS

### Summary

The subglacial aquatic environments of the Antarctic lie beneath kilometers of ice. Microbes of a number of types are found in low numbers throughout all depths of the ice sheet, carried to the Antarctic by atmospheric winds and deposited at the surface. Some of these survive their extremely slow downward travel through the ice and are still capable of respiration and growth when sampled in cores from thousands of meters below the surface. It is, therefore, highly likely that the subglacial aquatic environments contain microbes capable of growth and are constantly being inoculated with microbes from the ice sheet. The important question then centers on the probability that these environments support growing and evolving microbial populations. After considering the requirements for microbial growth and the chemical and physical conditions predicted for subglacial environments, the committee concluded that the hypothesis of microbial life and growth cannot be rejected. Therefore, future exploration of these environments must assume an aquatic ecosystem containing growing microbial populations. This assumption affects issues of preservation of habitats and minimization of contamination during exploration. The uncertainty can be resolved only by direct sampling of the lakes and flowing waters beneath the ice sheet.

### Requirements for Life

The proliferation of microorganisms requires, at a minimum an inoculum of cells; water; electron donors and acceptors (e.g., reduced iron, sulfides, organic matter, oxygen) for biological energy supply; a source of nutrients (e.g., C, N, P, S, Fe, and other elemental constituents of biomolecules); sufficient time for reproduction; and the physical, chemical, or biological conditions that prevent cell destruction and promote growth. Subglacial aquatic environments have not been studied directly; therefore no unequivocal evidence exists to confirm the presence or absence of life in these ecosystems.

### Subglacial Aquatic Environments and Potential Microbial Communities

Two types of evidence have been used to predict what will be found in waters beneath the ice sheet. First, microbes exist in all extreme environments on Earth where there is water, from a depth of 10,000 m in the ocean to surface saline lakes and from subzero temperatures in the brine channels of ocean ice to hot springs. Subsurface microbial communities of land and ocean are driven by abiotically produced materials from the Earth's interior such as sulfides, hydrogen, and carbon dioxide. Based on this, it appears likely that actively growing microbes will be present in subglacial waters. Second, although Lake Vostok has not been studied directly, there are samples of the chemistry and microbiology of the ice that has been derived from the lake (accreted ice); these indicate that there are no environmental conditions that would rule out microbial life within the lake.

Another complication for predicting the present conditions in the subglacial waters is that rock particles from glacial scour and sediments from preglacial lakes might be present. These materials could be sources for biota as well as for electron donors and acceptors for chemotrophic and heterotrophic organisms.

No matter what their origin, the substrates required for microbial growth appear to be present in the water column of subglacial aquatic systems at low concentrations, although a richer microbial habitat may be provided in the underlying sediments. The supply rate of these substrates is one of the key unknowns; however, the concentrations of growth substrates are considered to be low, suggesting that these environments are oligotrophic. As a consequence, microbes adapted to these environments by necessity will most likely have highly proficient metabolic processes capable of taking advantage of extremely oligotrophic conditions including efficient recycling strategies. Depending on the level of carbon and nutrients available to the microbial community, metabolic activity and growth could be very low in some aquatic environments and some fraction of the community may represent a viable but metabolically inactive state. It is likely that microbial communities, if present and active, will only be able to grow extremely slowly.

The growth of accretion ice in Lake Vostok may have created an environment where oxygen concentrations are 50 times higher than in normal lake waters. This situation is likely to occur because enclathrated hydrates of atmospheric air contained in glacial ice are released into the lake when this ice melts. Accretion ice excludes gases as it grows; the result is supersaturation of the upper levels of the lake water with gases. Unless the gases are removed by mixing into the deep waters or by transport out of the lake, high concentrations of oxygen may result in the production of superoxide radicals and other reactive oxygen species that could be detrimental to life. Alternatively, if the subglacial lakes are stratified there may be low oxygenic levels and anoxic bottom waters and sediments where microbes could exist.

### Microbes in Glacial Ice and Subglacial Waters

The microbes in glacial and accretion ice have been examined by several methods. Microscopic and culture analysis of the Vostok ice core revealed bacteria, yeasts, fungi, and microalgae in glacial ice greater than 240,000 years old. In the oldest ice, only bacterial spores were found. Microbiological and molecular-based studies of the accretion ice found low but detectable amounts of bacterial cells and DNA. Molecular identification of microbes show that they are closely related to microbiota from the surface of the Earth: Proteobacteria, Firmicutes, Actinobacteria, and Bacteroidetes. Microscopic examination revealed bacteria, pollen, diatoms, and coccolithophorids. Of these, only the bacteria would be able to grow in the lake water.

Bacteria and yeasts from the accretion ice, thus presumably from Lake Vostok, respired glucose and grew on liquid and agar media. The total numbers of microorganisms detected in the accretion ice ranged from 100 to 900 cells mL<sup>-1</sup>.

Actual growth rates are unknown for bacteria in subglacial ecosystems, but are expected to be slow and possibly negligible in some situations. Analogous systems include the deep seafloor biosphere, where one report estimated that the bacterial turnover time is up to 22 years (Schippers et al. 2005). These slow rates of metabolism and growth also have implications for the extent of genetic adaptation to the subglacial

environment given that rates of evolution tend to be slow under conditions of low temperature (Gillooly et al. 2005) and low productivity (Horner-Devine et al. 2003).

### **The Possibility of Microbial Evolution**

If the source population of microbial communities in subglacial aquatic environments is derived from the overlying glacial ice, these populations have been isolated for at least 1 million years, which is the age of the oldest Antarctic ice. Against the backdrop of 3.7 billion years during which microbes have been present on Earth, 1 million years is not a long time in terms of evolution. In the case of Lake Vostok, rates of evolution are likely to slow under the conditions of low temperature and low microbial productivity. The result is likely to be that the metabolically active and growing microorganisms present in these communities should represent those better adapted to the ambient conditions but will still be related to microorganisms found in other environments today.

A much longer time for evolution may have occurred if, however, the original inoculum to Lake Vostok dates back to the time of the isolation of the lake from the overlying atmosphere more than 15 million years before the present. This time of isolation could be even longer if the founding populations were derived from rocks or sediments. In this latter case, the microbial populations could have been isolated from the surface approximately 35 million to 40 million years ago, prior to the formation of the lake.

Samples of microbes from water and sediment are the only way to answer these questions of the uniqueness of microbial life in subglacial aquatic systems. Although the effect of the extreme conditions is unknown, there is a chance that the microbes have been isolated long enough that significant genetic divergence of microbial lineages has occurred.

## 4

## Drilling and Sampling Technologies and the Potential for Contamination

### TECHNOLOGIES TO ACCESS SUBGLACIAL AQUATIC ENVIRONMENTS

A key issue in the exploration of subglacial aquatic environments is how to recover data and samples that are free of artifacts or contamination without irreversibly altering the environment under study. Current ice penetration and drilling technologies to reach the aquatic subglacial realm have been developed for projects to recover ice cores mainly for paleoclimate research or to most efficiently reach the subglacial bed for direct glaciological observation using fast access ice sheet drilling. Fast access ice sheet drilling generally proceeds without the recovery of a continuous ice core, and, in most cases, is used to reach scientific targets deep within or below the ice surface. This approach may be useful for the exploration of subglacial aquatic environments if drilling platforms such as (1) wire-line drilling, (2) hot-water drilling, (3) coiled-tube drilling, and (4) hybrid systems can be adapted for the purpose of fast ice sheet drilling. Other technologies, such as ice corers and thermo- or melt probes may also be adaptable for subglacial aquatic environments (SCAR SALE 2006). At present, each of these techniques has its own advantages and disadvantages, but a common technological challenge for all deep ice holes is to stabilize the hole against the lithostatic pressure within the borehole to prevent the hole from closing. Currently, this is accomplished by filling the holes with a fluid that will not freeze whose density is similar to the ice. The fluid acts to counterbalance the overburden pressure keeping the hole open.

Ice coring is an established method using standard mining and oil industry technology to reach the base of many ice sheets (SCAR SALE 2006); however the main objective of ice coring is to recover ice cores, not simply to drill a hole. Holes are generally left after an ice core has been extracted, and they vary in diameter between roughly 10 and 20 cm depending on the drilling equipment used. All deep ice core drills are electromechanical devices that recover ice cores and drill cuttings with each run. The drawbacks to using this technique are that usually two to four field seasons are required to drill to the bed and this technology requires the use of an antifreeze drilling fluid. Consequently, the use of existing coring systems to access subglacial aquatic environments may be limited. However, the borehole may

be used for sample retrieval from a subglacial lake if certain precautions are taken to ensure that the drilling fluids do not enter the subglacial aquatic environments.<sup>1</sup>

### Hot-Water Drills

Using hot water to melt holes into the ice is a well-established technique that has been used by several countries such as the United States (AMANDA, ICECUBE, Caltech), Australia, Germany, and the United Kingdom. Hot-water drills operate by pumping hot water from a heater through a hose under high pressure to a drill head, which melts the ice. This technique generates a hole filled with water, which is pumped to the ice surface where it is reheated and pumped back into the hole. The drawbacks of this technique are that holes are open for only a few hours because the water refreezes, the hole closes, and no cores are recovered.

Keeping holes open for more than a few hours necessitates constant reaming and input of heat, which requires significant amounts of fuel. Ideally, such holes could be considered clean because the water used to melt the holes comes from the melted ice itself and is constantly recirculated through the heaters and high-pressure pumps. However, this circuit through machinery is also a possible source of contamination. Soot or materials dissolved from the walls of the high-pressure hose may contaminate the waters that are pumped back into the hole.<sup>2</sup> These potential contaminants could be removed by introducing nanotechnology filters in the steam path and through the high-pressure (e.g., 8-10 MPa) steam itself. It is even conceivable to introduce a full autoclave system into the water circuit. Although this technique has been used to quickly drill several kilometers of ice and may be able to access some subglacial aquatic environments, more method development will be needed for this technique to achieve the ice depths that are required to reach many subglacial aquatic environments located beneath thicker ice.

### Melt Probes

Melt or thermo-probes represent another technology that shows promise to access subglacial aquatic environments. It should be noted however, that to date, the melt probe concept has not yet achieved this. Originally designed by Philbert & Philbert as a system to remotely measure temperature within the Greenland ice sheet, melt probes have so far reached a maximum depth of about 1600 m. The probes have a heated element at the tip, which melts ice as it descends. The water refreezes behind the probe, which is tethered to the surface via cable. Such melt probes could conceivably reach subglacial aquatic environments in a sterile fashion. Once in position, these probes could collect remote measurements and provide data communication with the surface.

---

<sup>1</sup>Despite precautions, drilling fluids may enter the subglacial aquatic environments, but these fluids will most likely not adversely affect the environment. For example, if one takes the diameter of the Vostok core hole as 15 cm and 4000 m as its length, the hole volume is roughly 70 m<sup>3</sup>. Based on geophysical surveys, the volume of Lake Vostok has been estimated as  $5.4 \times 10^{12}$  m<sup>3</sup> (Studinger et al. 2004). Thus, if the full fluid content of such a core hole was injected into a well-mixed lake of this volume, the dilution factor would be  $1 \times 10^{-11}$ .

<sup>2</sup>Dissolution of the high-pressure hose may result from interaction with the high-pressure, high-temperature steam generated from the heaters and pumps.

At present, there is no technology available for retrieval of such melt probes, which precludes using this equipment for sample recovery. The major disadvantage of using melt probes is that they cannot effectively penetrate ice with particulates and may stop or be diverted from the preferred course. As the borehole deepens, these impurities are concentrated within the borehole because there is no way to circulate the fluids away from the probe (SCAR SALE 2006).

### Fast Access Drilling

There are options, as yet untried, for rapid access drilling to the bed using technology from oil drilling industries, such as coiled-tube drilling or even wire-line drilling using conventional drill rigs. These technologies, however, are not presently capable of penetrating ice sheets to greater depths and are not suitable for the conditions likely to be encountered during drilling subglacial aquatic environments. These technologies need to be adapted before they can successfully be used to access subglacial aquatic environments. Development of a new ice sheet drilling platform that will provide access to deep samples of ice and subglacial materials and enable fast completion of arrays of boreholes distributed over large areas (tens and hundreds of kilometers in one season) was the focus of a workshop sponsored by the National Science Foundation.<sup>3</sup> The FASTDRILL workshop identified four potential drilling platforms, which may be adapted for the purpose of fast ice sheet drilling.

### Wire-Line Drilling

Wire-line drilling is a standard mining and oil industry technology already widely used in cold climates with many relatively inexpensive and standard accessories available for deployment in support of polar research. This technique is currently being used in Antarctica in the Antarctic Geological Drilling (ANDRILL) project. Although this system is limited to ~2.5 km in its current configuration, it may be useful for relatively shallow subglacial aquatic environments. To reach deeper environments, such as Lake Vostok, the maximum drilling depth would have to be increased. In addition, further analysis is necessary to evaluate whether the weight and size of such drills will preclude their deployment with aircraft (LC-130) and prevent moving this system in the field.

### Hot-Water Drilling

Hot-water core drilling is another fast drilling technique that can also recover cores. In the past it has been the primary fast access technology in ice-sheet environments mainly to depths <1.5 km (Engelhardt et al., 2000) and is the most established technology for making access boreholes to the bottom of ice sheets. The drill system consists of small hot-water jets contained in an annulus that melts the ice around a core and can be used in conjunction with coreless hot-water drilling. This system has minimal infrastructure and would be quite mobile, which may permit several sites to be sampled in a season. However, in its current configuration, this technique has

---

<sup>3</sup>FASTDRILL: Interdisciplinary Polar Research Based on Fast Ice-Sheet Drilling. Report of an NSF-Sponsored Workshop Held at University of California, Santa Cruz, October 23-25, 2002. A PDF version of the report can be found at [http://es.ucsc.edu/%7Etulaczyk/Report\\_I\\_V.pdf](http://es.ucsc.edu/%7Etulaczyk/Report_I_V.pdf).

serious limitations for the exploration of subglacial aquatic environments. A lack of control of borehole dimension and geometry, difficulty in obtaining subglacial cores, and the lack of continuous coring capability are major disadvantages. In addition, the lack of casing makes it difficult to maintain a sterile environment around the core and the hot water may cause thermal shock to the outer part of the core if it is recovered. Moreover, power requirements for hot-water drilling of access boreholes through deep ice (2-4 km) are very high.

### Coiled Tubing Technology

Coiled-tubing technology is now a fairly mature technology used by the oil and gas industry, especially in the Arctic. This technology can be used as a more capable version of a hot-water drill, with greater control during drilling and flexibility in deploying different downhole tools. Although it is commercially available, its suitability for FASTDRILL applications needs to be evaluated in polar ice sheet drilling.

### Hybrid Systems

It appears that at the present time no single technology exists that provides a means to access subglacial aquatic environments in a clean manner. It may be possible, however, to combine different drilling technologies to reach this goal. For example, it may be possible to use coiled tubing with a hot-water tip for melting through ice and then switch to wire-line technology for recovery of long cores. Development of a hybrid drill, combining some characteristics of two or three basic drilling technologies, may also provide a way forward.

### Coiled-Tube Drilling for Ice

Recent technological advances in coiled-tube drilling by the commercial oil and gas industry may lead to the development of a system capable of rapidly drilling through 3-4 km of ice in several days. This proposed system, coiled-tube drilling for ice (CTDI) uses a metal or advanced-composite tube to deliver fluid to a hydraulic motor that drives a cutting bit within the borehole. An advantage of this system is that it combines the best aspects of mechanical drilling with the speed of coiled-tube drilling. Ice chips generated by drilling are removed as the drilling fluid is pumped through a continuous hose. This technique can provide continuous drilling, unless ice cores are desired.

Expectations are that this technique will permit drilling rates as fast as 40 m hr<sup>-1</sup> in polar ice, which would mean that this system would be capable of drilling through 3-4 km of ice in six to eight days, including setup time. The system would be aircraft (LC-130) transportable and sled mounted for rapid mobilization and demobilization. The drill speed and portability of this system would enable an array of deep boreholes to be drilled in a single season. Tubing sizes used to drill a 54-mm borehole can be as small as 25-mm inside diameter, thereby reducing the volume of borehole fluid. This is a clear advantage in case of a blow-out, where only minimal fluid will be ejected. The drill system would be able to produce semipermanent uniform-diameter holes with minimal thermal disturbance and be capable of acquiring rock cores, frozen sediment cores, and short ice cores. The modular and flexible design proposed for this system would facilitate the addition of new tools to satisfy future research needs. The

capabilities of the CTDI would fill the void between existing deep ice core drills and hot-water drills.

The disadvantages are that the small-diameter boreholes make instrument deployment difficult. The drill would be mobile to some extent; however, it should be noted, that to reach a depth of 3800 m, the drill configuration would weigh tens of metric tons.

### Additional Considerations

Regardless of drilling technology, the problem of how to penetrate and sample subglacial aquatic environments without the introduction of borehole stabilizing fluids into these environments remains a challenge. The decisive factor is the pressure difference between the inside and the outside of the boreholes. Initially the obvious choice is to work with an underpressured hole leading to a rise of subglacial water inside the borehole for sampling. Due to the prevailing temperature gradient, this will lead to refreezing of the water rising into the borehole. If the water is to be sampled as a liquid this must be done very quickly, conceivably in heated containers, and transported to the surface. Alternatively, the frozen water may be sampled by additional drilling. This approach has been proposed to recover samples from Lake Vostok (Box 1.1). In all cases where water was encountered at the bed (i.e., Byrd and the European Project for Ice Coring at Dronning Maud Land [EPICA DML]<sup>4</sup> boreholes; the North Greenland Ice Core Project [NGRIP] borehole), the underbalanced hole option worked to keep the fluids in the hole, but the redrilled samples of refrozen subglacial water from NGRIP were found to be contaminated with drilling fluid (J. Priscu and S. Bulat, personal communication). Redrilling of the EPICA DML hole has yet to occur.

Another approach to reach subglacial aquatic environments is to use conventional electromechanical ice core drilling techniques to reach an environmentally safe depth above the top of a lake. This safe distance would preclude the possibility that microfractures in the ice would allow the borehole fluid to migrate along an intergranular vein network and enter the lake. Once the appropriate depth is reached, then other equipment and technology specifically designed for this operation would be employed. This approach was used by the Russian-led consortium to position the borehole above Lake Vostok in anticipation of entering the lake during the International Polar Year (IPY, 2007-2009).<sup>5</sup> The safe distance for Lake Vostok was calculated to be 30 meters above the lake surface (Russian Federation 2006).

This value was determined by considering the conditions that favor ice fracture—large stress differences and low confining pressure—and the permeability of ice with respect to the drilling fluid. Large fractures, or crevasses, form where stress differences are large and confining pressures are small; however, over subglacial lakes, stress differences are expected to be small and the confining pressure is extremely large due to the 4 km of overlying ice. The deviatoric stresses are believed to be small because the 220 m of accreted (lake) ice at Vostok forms an ice massif blocked against the eastern edge of the lake and overridden by the moving glacier. A shear layer (likely active) is found above the interface (around 3540 m depth) between the glacial and accreted ice.

---

<sup>4</sup>In Antarctica.

<sup>5</sup>The IPY extends from March 1, 2007, until April 2009 to permit two complete winter-summer seasons at both poles.



This suggests that fracture processes are suppressed or inhibited in the deepest section of the accreted ice (to be drilled).

The latter conclusion is fully supported by the high crystallographic structure of the ice crystals, as revealed by X-ray diffraction measurements (Montagnat et al. 2001), which is possible only if the lake ice does not plastically deform under the in situ conditions. Hence, the formation of open crevasses often observed in grounded ice can hardly be expected in the case of basal ice at Vostok (Russian Federation 2006).

The permeability of the accreted ice to the drilling fluid is expected to be low, because the accreted ice crystals show a lack of distortion, which essentially rules out a significant diffusion of the drilling fluid through the ice lattice (Montagnat et al. 2001). However the presence of liquid water along the grain boundaries provides a route for liquid transport. The veins form a continuous network of microscopic channels that remain liquid at subfreezing temperatures. Hence, contamination from the drilling fluid may be associated with both the downward advection of intercrystalline water and the diffusion of the drilling fluid through the vein system. Estimates of the total advection of the drilling fluid from the borehole toward the ice-water interface will be about 1 m over millennial time scales (Russian Federation 2006). In addition, helium data (Jean-Baptiste et al. 2001) support the presence of an upward component of velocity in the accretion ice layer of about 6 mm per year, which can be the result of hydrostatic compensation in this region (Souchez et al. 2004). This upward movement of ice, if present, would overcompensate a very slow downward advection of the fluid (Russian Federation 2006).

### NEEDS FOR TECHNOLOGY DEVELOPMENTS

Some technologies currently exist that can be used immediately in the exploration of subglacial aquatic environments. These include airborne radar, magnetic, and gravity surveys, land-based seismic surveys; and certain operational sensors that could be deployed within lakes exist for some of the more fundamental properties. Other technologies however, will require development. For example, experimental sensor arrays need to be developed for the detection of dissolved gases such as  $H_2S$ ,  $CH_4$ ,  $N_2O$ ,  $N_2$ , and argon, as well as major anions and cations and bioreactive redox couples such as ammonium and dissolved manganese. Currently available sensors will also need to be field-tested for compatibility with the expected temperature and pressure conditions of subglacial lake environments and environmental restrictions.

The participants of SCAR SALE (2006) stressed that the size of the sensor packages may not be suitable for the size of lake access holes and that limitations on the borehole size may require the miniaturization of existing technologies. It is conceivable that at least some of the subglacial aquatic environments may be substantially overpressure. Further technological developments, such as introducing pressure-tight locks in the bottom parts of a borehole may eventually be advisable to deal with this possibility as well as to sample subglacial lake bottom sediments.

Sample recovery poses its own set of challenges. Many of the standard oceanographic techniques for remote collection using water sampling bottles (e.g., Rosette Samplers with Niskin bottles) and sediment retrieval by coring devices (piston corers, gravity corers, box corers, grab samplers, etc.) use very large devices that are too large to fit through a drill hole; specialized sampling devices and techniques may have to be developed (SCAR SALE 2006). Sediment trap technologies and other water particu-

late collection devices are adaptable to subglacial environments. Another suggestion posed by SCAR SALE (2006) is the use of in situ, large-volume filtering devices to concentrate particulates for analysis in a clean surface laboratory following retrieval of the sampling device.

Geological drilling technologies remain to be fully developed; however, the current ANDRILL Program is establishing technology and techniques (a 2000-m-long drill string through up to 300-m thickness of floating ice on the sea) that are moving closer to what is required for subglacial lake sediment recovery. Existing ice drilling techniques appear to be capable of meeting the field requirements for penetration of 4 km or more of ice, penetrating low-temperature (subzero) and high-pressure environments.

The challenge for ice drilling is demonstration of the ability to do so with minimal and/or acceptable levels of contamination. Techniques are needed to ensure the purity of the drilling water fluid to avoid contamination from surface microbes. There may be solutions to this requirement in methods currently proposed to sterilize (ultraviolet radiation, ozonolysis) ballast waters in ships that prevent the introduction of non-indigenous species.

Future technologies required for the exploration and sampling of subglacial lakes (focusing on Lake Vostok) were the topic of a workshop funded by NSF (Rock and Bratina 2004).<sup>6</sup> The main goal of this workshop was to identify the technological challenges to sampling and exploring the waters and sediments of Lake Vostok and to generate recommendations to overcome these barriers. A number of findings and recommendations were developed and are summarized in Table 4.1. The workshop found no significant technological barriers to simple entry, exploration, and sampling of the lake in the region of the borehole. Interestingly, one of the major findings and recommendations was that required cleanliness levels needed to be set in order for the technology development to advance.

Collecting samples and data away from the region of the borehole incrementally increases the technical challenge. This type of research will require the use of robotic vehicles that are either tethered (remotely operated vehicles—ROVs) or not (autonomous underwater vehicles—AUVs). One of the biggest barriers to performing research in the subglacial environment using robotic vehicles will be designing the vehicles to be able to fit down a small-diameter borehole. The workshop (Rock and Bratina 2004) considered the possibility of remote assembly of smaller vehicle parts (e.g., below the ice) but concluded that this would be prohibitively challenging.

There is, however, a large and growing body of expertise in performing surveys with ROVs and AUVs in marine environments that can be drawn on for dealing with issues such as vehicle design, navigation, communication, and power. Enabling these vehicles to collect samples far from the borehole was deemed a significant challenge and beyond current technology. The workshop recommendations (Rock and Bratina 2004) encouraged the subglacial research community (through NSF) to draw on the expertise in the ocean science community to overcome these challenges and said that NSF should encourage the development of new and creative approaches to the exploration of subglacial aquatic environments.

---

<sup>6</sup>Final Report from the NSF sponsored workshop Lake Vostok: Defining a Technology Roadmap for Exploration and Sampling, March 27-29, 2003, Palo Alto, California. A PDF version of the report can be found at [http://salegos-scar.montana.edu/docs/Workshopdocs/Vostok\\_Technology\\_Workshop\\_Report.pdf](http://salegos-scar.montana.edu/docs/Workshopdocs/Vostok_Technology_Workshop_Report.pdf).

TABLE 4.1 Findings and Recommendations from Rock and Bratina (2004)

Findings	Recommendations
1. No fundamental engineering barriers exist that would prohibit entry of a (simple) probe into the lake (although significant engineering development might be required)	1. NSF should task a group to develop these specifications immediately (e.g., an American Society for Microbiology board or committee)
2. Quantifiable specifications that define acceptable levels of contamination do not currently exist and must be generated before detailed engineering efforts can proceed	2. All early missions that penetrate the ice should include an engineering feed forward component designed to collect relevant data
3. Critical data defining the operational environment for instruments (and vehicles) deployed within Lake Vostok are lacking	3. NSF should team with the ocean science community to exploit existing capabilities (e.g., vehicle and sensor technology) wherever possible
4. Significant development will be required to develop an underwater vehicle to deploy within the lake (e.g., through a small-diameter borehole)	4. NSF should team with the ocean science community to develop the capability to perform sample collection using AUVs
5. Significant research and development is required to create the technology required to collect samples at locations remote from a borehole (e.g., the grounding zones)	5. NSF should encourage new and creative approaches to the broad range of technological challenges associated with the exploration of Lake Vostok. Questions include: Are there creative or different ways to access the lake? Are there novel ways to provide long-term power to equipment in the lake? Are there new techniques to assemble a sensing system within the ice or within the lake?

The future technology workshop participants found that another impediment to the planning and design of technologies for subglacial exploration is the lack of knowledge about the aquatic environments (e.g., how corrosive is the water?). As a result, some technologies for more advanced stages of the research may not be able to be developed reliably until after first entry and preliminary data collection occur.

### POTENTIAL FOR CHEMICAL CONTAMINATION

Chemical contaminants could enter a subglacial lake during exploration as liquid constituents of the drilling fluid and as solutes or particulates in that fluid. Direct chemical contamination could also occur from the drilling and sampling apparatus, for example, from water-soluble oils used in metal working during the fabrication of the instruments and equipment and from phthalate ester additives that are used extensively in the plastics industry. The nature and magnitude of chemical contamination from each of these sources will be highly specific to the type of drilling and sampling operation.

### Drilling Fluids

Drilling fluids have varied in the past. At present there are basically two types of drilling fluids. One fluid is kerosene based (Shell Exxol D40/D60) with an appropriate amount of hydrochlorofluorocarbons (HCFCs) added to reach a density of 900 to 920 kg m<sup>-3</sup>; the other is *n*-butyl acetate. Both types of drillings fluids have served their purpose well, but the Montreal Protocol and certain health hazards with the *n*-butyl acetate lead to a continued search for more environmentally benign substances. These substances however must retain low viscosity at the lowest temperatures encountered. Several new drilling fluids have been proposed in the past several years. The latest developments in this sector are tests of fatty acid esters such as ESTISOL 240 by Danish drillers in Greenland (J. P. Steffenson, personal communication) and non-toxic, non-aromatic paraffin hydrocarbons including Isopar-K by U.S. drillers in Antarctica (WAIS Divide Ice Core Project). Thorough testing of these fluids still remains to be performed to fully characterize the temperature dependence of miscibility behavior (for multi-component fluids), viscosity, and the nature of fluid/chip interactions under an appropriate range of temperatures and pressures.

Regardless of which drilling fluid is used, none is sterile when purchased. This is especially true with kerosene-based fluids because there are a number of organisms live in this type of drilling fluid. To help combat potential microbial contamination, bactericides (e.g., BHT—butylated hydroxytoluene) have been added to drilling fluids. The drilling fluid proposed for the West Antarctic Ice Sheet (WAIS) Divide project is ISOPAR-K with a HCFC 141b densifier. This fluid has 3 parts per million (ppm) of BHT added to Isopar liquids by the manufacturer (J. Priscu, personal communication).

Chemically, kerosene-based drilling fluids, such as those used in the Vostok 5G site and EPICA (Shell Exxol D40), are heterogeneous mixtures of mostly alkanes; however, other kerosene-based drilling fluids also contain benzene, toluene, xylene, alkylbenzenes, and various polycyclic aromatic hydrocarbons (PAHs) including naphthalene and alkylnaphthalenes (Irwin et al. 1997). Alkyl PAHs are toxic and constitute a high percentage of the total PAHs in kerosene; for example, these compounds constitute 97.6 percent of the PAH concentrations detected in fuel-contaminated sediments (Irwin et al. 1997). Other drilling fluids include *n*-butyl acetate, as used at the Dome Fuji site in Antarctica and on the Greenland ice sheet at the GISP2 borehole (Table 4.2).

Contamination from kerosene is typically measured by gas chromatography-mass spectrometry (GC-MS), and each fluid will have its own distinctive fingerprint. Considerable attention has been given to decontaminating Vostok ice cores from kerosene and, by association, any organisms associated with the drilling fluid.

A careful analysis of ice core decontamination protocols by Christner et al. (2005a) included GC-MS analysis of the kerosene content of successive layers of ice core. Hydrocarbon-derived ions with a mass between 70.7 and 71.7 were quantified relative to ion fragments from an internal standard and converted to kerosene values from a standard dilution curve. The outer layers of the cores had high kerosene concentrations, while the inner core was not significantly different from blanks (Figure 4.1).

Presumably much lower limits of detection could be achieved by using larger sample volumes or by targeting specific constituents with more sensitive analytical methods. For example, the lowest amount of benzene that can be detected by using a GC-photoionization detector method (0.2 µg L<sup>-1</sup>) is two orders of magnitude (100 times) lower than the concentration that can be detected by GC-MS (20 µg L<sup>-1</sup>), (see the following

TABLE 4.2 List of the Deepest Bore-Holes in Ice with Drilling Fluids Used

Years	Location	Organization or Project
1966	Camp Century, Greenland	U.S. CRREL
1967-1968	Byrd Station, Antarctica	U.S. CRREL
1972	Novolazarevskaya Station, Antarctica	Arctic and Antarctic Research Institute, USSR
1980-1981	Dye 3, Greenland	University of Copenhagen, GISP
1980-1986	Vostok Station, Antarctica	Leningrad Mining Institute, USSR
1986-1989	Vostok Station, Antarctica	Leningrad Mining Institute, USSR
1990-1992	Summit, Greenland	University of Copenhagen, GRIP
1990-1993	Summit, Greenland	University of Alaska, GISP2
1991-1993	Law Dome, Antarctica	Australian Antarctic Division
1993-1994	Taylor Dome, Antarctica	NSF/OPP
1996-1997	Camp North GRIP, Greenland	University of Copenhagen, NGRIP
1998-2003	Camp North GRIP, Greenland	University of Copenhagen, NGRIP
1996-1998	Dome F, Antarctica	Japanese Antarctic Research Expedition
1990-1998	Vostok Station, Antarctica	St. Petersburg Mining Institute, Russia
1997-1999	Siple Dome, Antarctica	NSF OPP
1999-2001	Akademii Nauk, Severnaya Zemlya	AARI, AWI
1997-2004	Dome C, Antarctica	EPICA, IPEV, PNRA
2001-2006	Kohnen Station/EDML, Antarctica	EPICA, AWI
2003-2006	Berkner Island, Antarctica	BAS
2004-2006	Dome Fuji, Antarctica	NIPR
2005 -?	Talos Dome, Antarctica	PNRA
2005 -	WAIS Divide	NSF OPP

NOTES: AARI = Arctic and Antarctic Research Institute; AWI = Alfred Wegener Institute; BAS = British Antarctic Survey; CRREL = Cold Regions Research and Engineering Laboratory; GRIP = Greenland Ice Core Project; IPEV = French Polar Institute; NIPR = National Institute of Polar Research; OPP = Office of Polar Programs; PNRA = National Research Program in Antarctica.

Depth (m)	Fluid	Notes
1391	Aqueous ethylene glycol solution; Fuel DF-A + trichlorethylene	
2164	Aqueous ethylene glycol solution; Fuel DF-A + trichlorethylene	Drill was stuck in the year during resumption of the drilling
812	Aqueous ethanol solution	Hole was plugged by ice chips
2037	Fuel Jet A-1 + perchlorethylene	Drill was stuck
2202	Fuel TS-1 + CFC 11	Drill was stuck
2546	Fuel TS-1 + CFC 11	Drill was stuck
3029	Solvent D60 + CFC 113	
3053	<i>n</i> -butyl acetate	Kevlar cable was damaged
1196	Fuel Jet A-1 + perchlorethylene	
554	<i>n</i> -butyl acetate	
1371	Solvent D60 + HCFC 123 Shell Exxol D60 + HCFC 141b	The drill was stuck, not recovered
3086	Shell Exxol D60 + HCFC 141b Small amounts of aqueous ethanol solution in deepest 100 m	Subglacial water rose in borehole at completion
2500	<i>n</i> -butyl acetate	The drill was stuck, not recovered
3623	Fuel TS-1 + CFC 11; Fuel TS-1 + HCFC 141b	
1003	<i>n</i> -butyl acetate	
723	Fuel TS-1 + HCFC 141b	
3270	Shell Exxol D60 + HCFC 141b Insignificant amount of aqueous ethanol water solution	First drill stuck in 781 m, not recovered
2774	Shell Exxol D40 + HCFC 141b Insignificant amount of aqueous ethanol water solution	Subglacial water rose in borehole at completion approx. 160 m
948	Shell Exxol D60 + HCFC 141b	
3028	<i>n</i> -butyl acetate	
?	Shell Exxol D60 + HCFC 141b	
?	ISOPAR-K + HCFC 141b densifier	

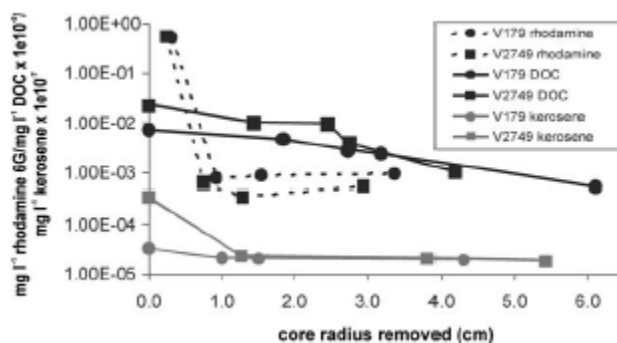

FIGURE 4.1 Decontamination of Vostok accretion ice cores as measured by reduction in an added fluorescent tracer (rhodamine), dissolved organic carbon concentrations, and kerosene concentrations. SOURCE: Reprinted from Christner, B. C., Mikucki, J. A., Foreman, C. M., Denson, J. and Priscu, J. C., 2005a, *Glacial ice cores: a model system for developing extra-terrestrial decontamination protocols*, *Icarus* 174:572-584. Copyright (2005), with permission from Elsevier.

web site for analytical methods and detection limits for this and other pollutants: <http://www.pacode.com/secure/data/025/chapter16/s16.102.html>). Total organic carbon measurements could also provide a guide to contamination above baseline levels, with a detection limit of  $10 \mu\text{g L}^{-1}$  (Christner et al. 2006).

### Miscible Fluids and Solutes

The drilling fluid may contain various additives and tracer recoveries (e. g., rhodamine as in Figure 4.1). For example, Chlorofluorocarbon-11 (CFC-11) has been added as a densifier at the Vostok site. CFCs have been detected as contaminants in McMurdo Dry Valley lakes at concentrations up to  $3.5 \text{ ng L}^{-1}$  (Tyler et al. 1998). The detection limits reported in that study using a purge-and-trap gas chromatography system were  $5 \text{ pg kg}^{-1}$  for CFC-11 and CFC-12 and  $10 \text{ pg kg}^{-1}$  for CFC-113.

Additional contaminants may be dissolved in the fluids, including persistent organic compounds such as polychlorinated biphenyls (PCBs). The limit of detection for most congeners, for example, in groundwater is  $0.1\text{-}0.5 \mu\text{g L}^{-1}$  (ppb) using U.S. Environmental Protection Agency (EPA) Method 608/SW-846 Method 8082.

Persistent fluorinated contaminants such as long-chain perfluorinated acids and heptadecafluorooctane sulfonamide (FOSA) are a new class of pollutants associated with chemical manufacturing of some products, and their appearance has now been detected throughout the world including polar bears in the Arctic (Martin et al. 2004). These compounds can be detected in picogram quantities by liquid chromatography-mass spectrometry (LC-MS).

### Chemical Contaminants from the Drilling and Sampling Equipment

Chemical contaminants from drilling and sampling equipment will depend on the composition of the equipment, its fabrication history, and cleaning protocols prior to use. Machine oils (cutting fluids) are routinely used in metal working to cool the cutting tools and to wash away the metal filings ([http://www.mfg.mtu.edu/testbeds/cfest/fluid.html#cfintro\\_name](http://www.mfg.mtu.edu/testbeds/cfest/fluid.html#cfintro_name)). They may be mixed with lubricants and typically contain many additives including hydroxyalkylamines as emulsifiers, chlorinated paraffins to control viscosity, corrosion inhibitors such as sodium nitrite, and biocides to prevent microbial growth. The addition of nitrites can result in the production of toxic N-nitroso compounds (nitrosamines) such as nitrosodiethanolamine (NDELA), which can occur in high concentration in water-based cutting fluids. The detection limit for NDELA and other nitrosamines in aqueous systems is 20 pg by GC-MS (Wigfield et al. 1988).

Phthalate esters are widely used as plasticizers in polyvinyl chloride (PVC), polyvinyl acetates, cellulose, and polyurethanes. Their solubility in water varies by orders of magnitude depending on the length of their alkyl chain. A large collection of literature exists on their distribution and bioaccumulation throughout the environment. Limits of detection vary with the method applied and can be less than 50 ng L<sup>-1</sup> in water using solid phase extraction (Staples 2003).

Rubber hosing has the potential to release a variety of contaminants. For example, styrene, used in the synthetic rubber industry and in the production of other polymers, is required to be monitored in U.S. drinking water supplies if levels exceed 500 ng L<sup>-1</sup> (<http://www.freedrinkingwater.com/water-contamination/styrene-contaminants-removal-water.htm>).

### POTENTIAL SOURCES OF BIOLOGICAL CONTAMINATION

Any form of invasive sampling of a subglacial lake will result in some level of perturbation to the environment in question. Since many of the subglacial aquatic environments are likely to contain a low biomass of microbes it is of critical importance to minimize the introduction of exogenous microbes, whether living or dead, and even of exogenous nucleic acids to (1) prevent changes in the native microbial composition and (2) allow for proper investigation of the native microbial community (and not contaminants) of the subglacial lake environment.

Potentially, a variety of allochthonous microbes (“contaminants”) could be introduced into subglacial lake environments via drilling and sampling activities. These allochthonous microbes may include microorganisms native to the surface environment or introduced from humans or equipment brought to the sampling area. Microbes immured in glacial ice for long periods of time might conceivably proliferate once they are released back into the modern-day biosphere through natural melting processes or through research activities. The majority of this release is likely to be of prokaryotic organisms, although possible introduction of microeukaryotes and viruses cannot be discounted (e.g., Rogers et al. 2004; Smith et al. 2004). For example, tomato mosaic virus, a member of the highly stable tobamovirus group, has been isolated from decontaminated Greenland ice cores ranging in age from <500 to 140,000 years before the present (Castello et al. 2005). Human and animal pathogens are also likely to be present in glaciers and ice sheets (Shoham 2005). Even if these microbes and pathogens



did not grow, their presence might confound measurements based on macromolecules (e.g., DNA, proteins).

Unless these microbes are introduced along with substrates that provide them a nutritional edge, it is less likely that allochthonous microbes would outcompete autochthonous (already present) ones. Microbes recovered from subglacial aquatic environments may not survive in surface environments due to a variety of factors. For example, it is more likely that microbes released from the overlying ice sheet into the atmosphere would survive more readily than microbes recovered from subglacial lakewater, given that long-term preservation would be more effective in deep frozen ice than in liquid-water conditions.

In addition, subglacial microbes may be light sensitive, may not be able to adapt to a more nutritionally rich environment, may not be able to survive under lower pressures or they may be more sensitive to new populations of grazers or other predators. These features would place them at a disadvantage relative to other taxa if they were transferred into less severe environmental conditions, where they would likely be out-competed by the native microbiota. As discussed in Chapter 3, even microbes isolated in ice for 1 million years are unlikely to have a genome exhibiting significant genetic divergence because of the slow pace of prokaryotic evolution.

The work of Karl et al. (1999) on water from accretion ice, however, does suggest that some fraction of recovered microbes could remain viable at the surface. Spores that might be either introduced to or removed from subglacial aquatic environments represent a potentially different situation because they are able to survive under many extreme conditions over very long time frames (millions of years) (Vreeland et al. 2000). For example, spores present in a subglacial lake environment such as Lake Vostok might have been deposited millions of years ago prior to the formation of the lake and, if returned to the surface, could become viable once more.

#### OTHER POTENTIAL SOURCES OF CONTAMINATION— PARTICULATES IN THE FLUID

This category includes biotic constituents such as bacterial cells, viruses, and fungi. Drilling fluids at the Vostok site (Alekhina et al. 2007) and at the EPICA sites (S. Bulat, personal communication) are known to contain many microbial taxa, including genera such as *Sphingomonas* that have also been detected in hydrocarbon-contaminated soils in Antarctica and elsewhere and on Greenland ice cores (Alekhina et al. 2007). Technologies that are under development for the detection of life in subglacial lakes (e.g., fluorescence-based systems; see Bay et al. 2005) may also provide sensitive detection of dissolved and particulate organic contaminants.

Abiotic particulates are probably best monitored via turbidity sensors that could be lowered down the access holes. A variety of optical backscattering instruments are used routinely for water column profiling in limnology and oceanography, and these have detection limits at or below 1 NTU (nephelometric turbidity unit).<sup>7</sup>

---

<sup>7</sup>Drinking water should not have a turbidity above 1 NTU, although values up to 5 NTU are usually considered safe.

### Combined Microbial and Chemical Contamination

Drilling fluids can be heavily contaminated not only with microorganisms but also with the substrates that they use for growth (Alekhina et al. 2007). The release of this inoculum plus growth medium into the relatively warm (by comparison with the ice hole and surface environment) liquid-water conditions of a subglacial lake could result in a short-term phase of increased metabolism and growth. A variety of hydrodynamic circulation processes are likely to operate in Lake Vostok and other subglacial waters, and localized inputs of contamination could be widely dispersed, including between lakes via subglacial hydrological networks.

### Isotopic Contamination

Naturally occurring stable isotopes and radioisotopes are routinely analyzed in biogeochemical studies and provide many insights into the structure and functioning of aquatic ecosystems. The relatively small transfer of unusual isotopes during lake access (e.g., from drilling fluids) or by release of deep water and sediments into the upper water column (see below) could potentially compromise the geochemical interpretation of some isotopic signatures. These problems have been encountered in the McMurdo Dry Valley lakes where a variety of radioisotopic and stable isotopic techniques have been used in situ, and where  $^{14}\text{C}$  contamination of some waters has precluded the use of radiodating techniques.

### Intrasystem Contamination

In two NSF-sponsored workshops concerning environmental management of the McMurdo Dry Valleys, it was recognized that research activities targeting one component of the environment had the potential to cause contamination or damage of another. Accordingly, an Environmental Code of Conduct was developed that included specific measures to minimize or avoid such effects on the aquatic microbial ecosystems of this region (Vincent 1996; Wharton and Doran 1999). For example, the anoxic bottom waters of the McMurdo Dry Valley lakes have a high nutrient and metal content that, if discharged to the surface waters or overlying lake ice, could potentially enrich or inhibit the microbial communities growing in those strata. The Code of Conduct now requires that all sampled water, including that used to rinse and clean bottles, routinely be removed from the valleys.

In subglacial lakes there also may be large differences in chemical properties among liquid-water strata, including the possibility of anoxia at depth in the water column and in the sediments (Siegert et al. 2003). Releases of water during sample removal could enrich or inhibit communities in the water column or overlying ice. As in lakes elsewhere (Wetzel 2001), the sediments underlying subglacial lakes are likely to contain orders-of-magnitude higher concentrations of microbiota, nutrients, and metals. The benthic microbial communities also are likely to have a very different phylogenetic composition than those in the water column, and transfers during sampling could compromise subsequent measurements of water and ice samples (e.g., DNA clone library analysis).

The glacial ice is likely to contain a variety of viral, bacterial and fungal species (e.g., Ma et al. 2005; Christner et al. 2005b) including organisms that could potentially

grow in the solute-rich water sequestered between the triple junctions of ice crystals (Price 2000). These microbiota could be transferred deeper into the system through sampling and could potentially grow (e.g., in meltwaters produced during hot-water drilling). In the Lake Vostok core, different sections of the accretion ice contain materials frozen in from different parts of the lake, allowing contamination from one part of the lake to another. This latter effect is likely to be small; however, if hydrodynamic processes are operating across the lake, the effect could be magnified. Furthermore, the melting of overlying glacial ice is a continuous natural source of microbiota for Lake Vostok and probably other subglacial lakes.

### POTENTIAL FOR TESTING AND ASSESSING CONTAMINATION: EXPERIENCES FROM DEEP-BIOSPHERE SAMPLING

The advent of molecular and genomic approaches to biological measurements has continued to broaden our concepts and understanding of microbial diversity. It is now commonplace to sample the presence and diversity of microbial communities from many environments throughout the biosphere. Of particular importance to these investigations, especially those occurring in areas where biomass is predicted to be low (such as the deep biosphere), is the prevention of contamination of the environment and subsequent samples with exogenous life or nucleic acids.

Most protocols examined to date have focused on preventing (or at least minimizing) contamination of samples extracted from the environment in question and, by extension, providing a measure of protection to the environment itself. These protocols center on (1) using advancements in drilling technology to obtain the necessary depths and (2) incorporating the use of sterile liners and other sterile devices for extracting samples from rock, sediment, or water.

Most protocols for sediment cores recommend further processing of the core under sterile conditions and removing interior portions for actual microbiological analysis. The inclusion of tracer studies to track possible contamination during any deep-biosphere sampling has also been viewed as an important approach to these studies. Interestingly, much less emphasis has been placed on determining the risks or effects of reverse contamination—where the surface environment or personnel operating drilling equipment or collecting samples are exposed to microorganisms from the deep environment under investigation.

### Terrestrial Deep Subsurface Drilling

Investigation of microbial life in the deep biosphere represents an important undertaking in the search for the nature and diversity of microbial life. The majority of experience gained thus far in sampling has occurred in the terrestrial deep subsurface (>100-m depth) including groundwater, aquifer sediment, and rock matrices. The ability to conduct sampling in these environments has been aided by advances in specialized drilling technologies. In terrestrial settings, rotary drilling is a common method when drilling to depths >100 m, although cable tool drilling has also been used to obtain high-quality samples for microbial analysis from unconsolidated sediments from at least 200 m and has the advantage that no recirculating drill fluids are necessary. Push-type core barrels such as split-spoon core barrel devices are the most common samplers used in cable drilling to obtain core samples of formation materials for microbiological

sampling. These devices are advantageous; they can be disassembled readily for cleaning, and sterile inner core liners can be used. Rotary drilling and coring is a commonly used technology for obtaining samples from deep subsurface environments. Similar to ice coring, this system also requires the use of drilling fluids, which can be problematic due to the presence of bacteria (Hurst 1997).

Alternative methods that have demonstrated some success in reducing microbial contamination involve the use of inert gases (e.g., argon, nitrogen), although their application can be most effective only at more limited depths because of the extreme hydrostatic pressures that must be overcome when boreholes fill with groundwater. A Gel-Coring system (Baker-Hughes, Casper, Wyoming) has been used with some success. With this method, a core liner is first filled with a viscous, inert gel, which surrounds the core as it advances, forming “platelets” that confine the core, thereby decreasing its exposure to oxygen and drilling fluids (Hurst 1997).

To estimate sample quality, including contamination by drilling fluids, inert tracers can be used. Commonly used tracers principally for geochemical analyses are bromide, rhodamine, and fluorescein. Tracers that have been applied in terrestrial subsurface sampling for microbial analyses include a microorganism with an uncommon but easily detected phenotype (e.g., a distinguishing pigment). Obvious concerns exist with (and regulations may prohibit) the introduction of another microbial life form in many sampling situations. Alternatives include the use of fluorescent microspheres. Microspheres are readily available in a range of sizes and charges and with different fluors that are easily detectable via epifluorescence microscopy (Hurst 1997).

### Deep Subsurface Ocean Drilling

The Integrated Ocean Drilling Program (IODP), operating from 2003 to the present (built from the successful legacy programs, the Deep Sea Drilling Program [DSDP] and the Ocean Drilling Program [ODP]), represents an international scientific research plan focused on the exploration of the deep biosphere of the Earth’s crust and sediments from deep beneath the ocean (<http://www.iodp.org>). As a part of this program, several studies have been conducted to examine methods of monitoring microbial contamination of sediment cores and rock recovered from the deep ocean subsurface. The methods employed were adaptations of techniques used in land-based drilling as described above. Results of this work tested during the Leg 185 cruise (Smith et al. 2000) are summarized below.

The use of chemical and particulate tracers was evaluated to track microbial contamination (Smith et al. 2000). These tracers were introduced while drilling (1) unconsolidated sediments using an advanced piston corer (APC), (2) sedimentary rock using an extended core barrel and rotary core barrel (RCB), and (3) igneous rock using the RCB and diamond core barrel. Perfluorocarbon tracers (PFTs) that could be measured by gas chromatography and a particulate tracer of fluorescent microspheres that could be measured by epifluorescent microscopy were tested. The importance of verifying that the PFT had been delivered effectively with each sample was noted (otherwise the lack of measurable PFT in the core is merely a false negative). Conclusions from these evaluations were that both tests should be included for monitoring contamination.

Because the PFT analysis can be performed quickly, it represents a mechanism that could be used for the early detection of possible contamination during the sampling process. In the tests described, the lower limit of detection was  $6 \times 10^{-12}$  g of PFT

and higher sensitivity was expected with the use of smaller bore GC columns or possibly a less volatile PFT (Smith et al. 2000). Results of PFT measurements suggested that drilling fluid infiltration was in the range of nanoliters per gram of core material, leading researchers to conclude that depending on the coring methods used and the formations sampled, contamination may represent at most 1-10 bacteria per gram of core material. Intrusion of fluorescent microspheres into the core interior was not detected in the APC-cored unconsolidated sediments or RBC-cored consolidated sediment or rock. However, microspheres were detected in thin sections tested from the igneous rock samples, leading researchers to conclude that processing of the rock after sample extraction was the likely source of contamination (Smith et al. 2000). PFT and fluorescent microsphere tracers have seen continued use in deep sea subsurface sampling conducted by the IODP (D'Hondt et al. 2004), and methodologies for contamination-free sampling and monitoring continue to be investigated (Lever et al. 2006).

#### POTENTIAL FOR TESTING AND ASSESSING CONTAMINATION: EXPERIENCES FROM INTERPLANETARY RESEARCH

Requirements for cleaning are driven by mission requirements (as set out by the National Aeronautics and Space Administration [NASA]) and are based upon landing or regional concerns on the target planet or moon. Current sterilization levels are based on criteria established during the Viking pre-launch biological research conducted in the 1970s and are accepted and implemented by NASA as current requirements. Examples of specific measures to control contamination include reduction of the spacecraft's biological burden, a spacecraft organic inventory and material archive, and documentation of spacecraft trajectories and restrictions on returned samples.

Reduction includes sterilization and cleaning by approved and certified techniques. Sterilization requires that the entire landed system be sterilized at least to Viking post-sterilization biological burden levels or to levels of biological burden reduction driven by the nature and sensitivity of the particular life detection experiments, whichever are more stringent. Subsystems that are involved in the acquisition, delivery, and analysis of samples used for life detection must be sterilized to these levels, and a method for preventing recontamination of the sterilized subsystems is also required. Terminal sterilization methods (the terminal Viking bake-out process) were conducted after the lander had been sealed inside the aeroshell and bioshield capsule. The entire capsule was placed inside a thermal chamber (specially designed for the sterilization process) and the methods were verified by proxy; a sterilized spacecraft or component is never assayed directly. The acceptable terminal sterilization bioburden level was derived from the Viking pre-sterilization level of  $3 \times 10^5$  spores per vehicle, which was reduced after bake-out by four orders of magnitude to a calculated value of 30 spores per vehicle. Such an approach using heat treatment is clearly impracticable in general for Antarctic sampling at present, although it may prove possible to apply it to the final sampling assembly if this is sealed inside a shell for transfer down the drill hole.

Cleaning requirements for spacecraft or parts that do not require terminal sterilization are driven by the pre-bake-out bioburden levels determined analytically on the Viking landers to be  $3 \times 10^5$  spores per vehicle. Bioburden reduction techniques include clean-room assembly practices, dry heat to reduce the number of microbes, and physical cleaning of spacecraft components and surfaces. Clean-room assembly requirements

include Class 100K (International Organization for Standardization [ISO] Class 8) or better for spacecraft and payload assembly. Personnel controls include requirements for hoods, face mask or beard covers, sterile gloves, booties, taped wrists and ankles to prevent gaps between gloves and suits, and frequent (daily) change-out of clean-room garments. Additional assembly measures include attentiveness to bioload requirements including certification of manufacturing process such as cleaning procedures and products associated with clean room garments, tool sterilization and cleaning, and certification training in planetary protection practices for everyone associated with the spacecraft. When necessary physical barriers within the clean room are used to prevent cross-contamination from noncertified personnel or non-spacecraft-related activities.

Dry heat microbial reduction techniques require that specified heat, humidity, and exposure duration parameters are met, so that treated components may “take” a predicted order-of-magnitude bioburden reduction as specified by NASA Procedure Requirements (NPRs). Microbial reduction is often applied to parts that cannot easily be cleaned and assayed, such as thermal blankets or multilayer insulation constructed in such a manner that the material has a calculated high burden density but cannot readily be cleaned using manual methods.

Physical cleaning of spacecraft is accomplished mostly by wiping surfaces using isopropyl alcohol and sterile clean-room cloths. Physical removal of bacteria via wiping is implemented rather than using bacterial agents to kill surface bacteria. If the part or component can withstand autoclaving, this is also a suitable alternative. Prior to mating or installing components, surfaces are assayed to determine spore counts. The verification sampling is generally conducted in the assembly area, with the resulting sample transported to the laboratory for analysis. Assays are culture-based methods and require traditional plating techniques with a minimum three-day incubation period before final data are available. Verification assays are taken at “last access” for mated surfaces, but exposed areas on the spacecraft are routinely monitored as well to verify that the vehicle meets the required cleanliness levels through the months of assembly. Any time a surface is de-mated or rework occurs on the vehicle, the re-assay is required.

Many samples of bacteria were collected during the assay development phase of the Viking mission (Viking Collection and Teflon Ribbon Isolate Microbial Collection). These samples were taken via swab or wipe methods or using Teflon ribbons from spacecraft surfaces and assembly environments and were evaluated biochemically prior to storage. The isolates were lyophilized and sealed in glass ampoules and stored at Kennedy Space Center until recently when the collections were moved to the Jet Propulsion Laboratory. The Viking collection contains 1296 isolates; the Teflon Ribbon Isolate Collection contains 234 isolates. Currently there are no requirements to archive bacteria, although a limited effort is under way at the Jet Propulsion Laboratory to build a planetary protection bacterial archive based on clean-room and spacecraft samples obtained during the assembly process.

Planetary protection does require an archive of some materials used in spacecraft assembly (see requirement summary below), but there are no specific requirements to archive bacteria for each mission. However, with recent discussions of sample return and the ever-increasing understanding of planetary surfaces, an interest has resurfaced in typing and archiving pre-launch bioburden samples.

### WHAT LEVELS OF CLEANLINESS ARE FEASIBLE WHEN ACCESSING SUBGLACIAL ENVIRONMENTS?

Planetary protection cleanliness requirements are achieved in a closed environment, generally in class 100K clean rooms or other facilities that have controlled environments. Spacecraft and associated hardware are cleaned, assayed to confirm bioburden levels, and maintained clean throughout building and processing. The external environment of the spacecraft is controlled up to the time of launch to prevent recontamination. While the process is dynamic due to test and rework of hardware, for the most part hardware is accessible for recleaning and assaying. Once certified as clean, mated surfaces that are no longer accessible remain so by definition unless separated due to rework or reassembly requirements. In this environment it is possible to quantify the bioburden on the spacecraft and to maintain cleanliness requirements as dictated by planetary protection protocols.

Current levels of cleanliness associated with planetary protection standards are not feasible in the open environment associated with subglacial lake exploration. While it may be possible to control the quantity of cells associated with drilling and sampling operations initially, it is not possible to control the likely transfer and distribution of cells during the drilling and sampling process. Using current technologies, it is likely that operations will transfer cells between different strata in the borehole. Drilling and sampling equipment can be precleaned prior to penetration, but the extreme depths required for drilling and the fact that hardware cannot readily be accessed for recleaning make stringent bacterial cleanliness requirements such as those implemented in space research unachievable.

In addition the water environment of the lakes facilitates cell transfer from any object that may find its way into liquid water. If the lake has unique biological ecosystems, transfer may also occur as a robotic sampling device moves from ecosystem to ecosystem. In general, cleanliness requirements will have to be addressed in terms of (1) cleaning hardware (and quantification of bacterial levels and diversity) prior to penetration, (2) maintaining hardware cleanliness levels as much as possible during penetration, and (3) designing research techniques that minimize the possibility of cell transfer between different levels in the ice and the lake bed itself.

### BIOLOGICAL CONTAMINANT DETECTION

The detection of whole cells has traditionally relied on a variety of techniques including culture-based methods in which different media are used to grow organisms from a sample that can then be counted microscopically or as colonies on plates. These techniques are limited in scope because only those organisms capable of growing on a particular media formulation can be cultured, and these may constitute only a small fraction of the total community (Kämpfer et al. 1996). Microscopic counts of spores have also been used as proxies of bacteria (see **Potential for Testing and Assessing Contamination: Experiences from Interplanetary Research**). An important set of techniques for counting intact cells is the use of fluorescent dyes such as SYBR Gold, 4',6-diamidino-2-phenylindole (DAPI), and acridine orange (AO). These methods use epifluorescence microscopy or flow cytometry to quantify the fluorescent-stained cells, and they are appropriate to the ongoing analysis of Antarctic glacial ice and drilling fluids for environmental monitoring and management. Application of this approach

to samples from the lower strata of Vostok glacial ice has given counts of the order of  $10^2$  DNA-containing cells per milliliter of melted ice (Christner et al. 2006, Figure 2A), and this forms the basis for the committee's Recommendation 7.

Molecular biological and genomic approaches offer a suite of tools that can be complemented with culture-based techniques and biochemical methods to provide new and powerful strategies not only for gaining fundamentally new insights into the diversity of microbial life in subglacial aquatic environments but also for detection of exogenous cells and nucleic acids. A variety of molecular-based methods already exist and have been used extensively since at least the mid 1990's for surveys of microbial diversity and community structure (denaturing gradient gel electrophoresis [DGGE], terminal restriction fragment length polymorphism [T-RFLP], fluorescence in situ hybridization [FISH], clone libraries) that rely on the identification of nucleic acids and circumvent culturing biases. Of particular importance has been the construction of clone libraries of genetic markers that can be sequenced and analyzed using phylogenetic methods to assess microbial diversity using 16S rRNA (for prokaryotes) and 18S rRNA (for eukaryotes) gene sequences. For a review of the techniques discussed in this paragraph see Spiegelman et al. (2005). In the future, the use of other genetic markers or the use of multiple genetic markers should also be considered. There is no universal protocol for performing any of these techniques. Investigators should document their methods and results carefully, utilize appropriate controls, and work toward developing standardized protocols for contaminant detection and documentation.

Biology continues to undergo a revolution with the advent of new genomic, post genomic, and culturing techniques (Handelsman 2004; Page et al. 2004; Xu 2006). These rapidly progressing areas of science not only can be applied to studying microbial diversity and their functional roles in the environment but also hold great promise in providing rapid and sensitive methods for detecting and identifying the introduction of exogenous microbiota or nucleic acids. The ongoing development and application of these technologies with the goal of producing standardized protocols of methods and documentation of results should be strongly encouraged in the arena of biological contaminant detection.

## CONCLUSIONS

The problem of how to penetrate and sample subglacial aquatic environments in the cleanest manner possible remains a challenge because any form of invasive sampling of a subglacial aquatic system will result in some level of perturbation to the environment. Current drilling technologies are not sterile and it is not possible to guarantee that subglacial aquatic environments will not be contaminated during drilling, sampling, and monitoring. Drilling approaches that result in freezing subglacial water inside the borehole have worked well to keep the drilling fluids in the borehole (Byrd and EPICA DML boreholes in Antarctica and the NGRIP borehole in Greenland), but contamination of the core recovered by redrilling was evident.

During penetration and exploration of a subglacial aquatic environment, chemical contaminants could enter the water as liquid constituents of the drilling fluid and as solutes or particulates in that fluid. Direct contamination could also occur from the drilling and sampling apparatus, for example, from water-soluble oils used in metal working during the fabrication of the instruments and equipment or from phthalate ester additives that are used extensively in the plastics industry. The nature and mag-



nitude of contamination from each of these sources will be highly specific to the type of drilling and sampling operation.

Biological contamination of subglacial aquatic environments can come from a variety of sources that contain not only microorganisms but also the substrates they use for growth (Alekhina et al. 2007). Drilling fluids may contain both microbiota and growth substrates. The release of this inoculum plus growth medium into the relatively warm (by comparison with the ice hole and surface environment), liquid-water conditions of a subglacial lake could result in a short-term phase of increased metabolism and growth. It is of critical importance to minimize the introduction of living exogenous microbes, and even of exogenous nucleic acids, to prevent changes in native microbial composition and to allow for proper investigation of the native microbial community (and not contaminants).

A variety of allochthonous microbes (“contaminants”) could be introduced into subglacial aquatic environments from microorganisms native to the surface environment or from humans or equipment brought to the sampling area. Microbes could be transferred deeper into the system through sampling and could potentially grow (e.g., in meltwaters produced during hot-water drilling). Microbes immured in glacial ice for long periods of time might conceivably proliferate once they are released back into the modern-day biosphere through natural melting processes or research activities.

In subglacial lakes, large differences in chemical properties among liquid-water strata are possible, including the presence of anoxia at depth in the water column and in the sediments. Releases of water during sample removal could enrich or inhibit communities in the water column or overlying ice. As in lakes elsewhere, the sediments underlying subglacial lakes are likely to contain orders-of-magnitude higher concentrations of microbes, nutrients, and metals. The benthic microbial communities also are likely to have a very different phylogenetic composition than those in the water column, and transfers during sampling could compromise subsequent measurements of water and ice samples (e.g., DNA clone library analysis).

In addition, research activities targeting one component of the environment may have the potential to cause contamination or damage of another. Once contamination reaches the aquatic environment, a variety of hydrodynamic circulation processes are likely to operate in the subglacial waters, and these localized inputs of contamination could be widely dispersed. This is particularly important for subglacial aquatic environments that are connected via subglacial hydrological networks. However, protocols or codes of environmental conduct may be developed to include specific measures to minimize or avoid such effects on the aquatic microbial ecosystems of these environments. If downstream sites are the initial targets of investigation, this may reduce the potential risk of contamination to other environments along a specific flow path.

Molecular biological and genomics approaches have made it routine to sample the presence and diversity of microbial communities from many environments throughout the biosphere. Of particular importance to these sampling regimes, especially those taking place in areas where biomass is predicted to be low, is the prevention of contamination of the environment and subsequent samples with exogenous life or nucleic acids. These precautions should seek to preserve both the subglacial aquatic environment and the integrity of the scientific samples.

Most protocols, that focus on preventing contamination of the environments and protecting the integrity of samples extracted from the environment have employed advancements in drilling technology to obtain the necessary depths and allow the

use of sterile liners and other sterile devices for obtaining sample cores (for solids) or liquids. Most protocols for sample cores recommend further processing of the core under sterile conditions and removing interior portions for actual microbiological analysis. The inclusion of tracer studies to complement and track possible contamination during any deep-biosphere sampling is also an extremely important step in most protocols examined.

Current levels of cleanliness associated with planetary protection standards are not feasible for the exploration of subglacial aquatic environments. Although it may be possible to control the initial number of cells associated with drilling and sampling equipment using current technologies, it is not possible to prevent the transfer and distribution of cells between different strata in the borehole during the drilling and sampling processes. Drilling and sampling equipment can be cleaned prior to entering the ice, but the extreme depths achieved during drilling and the fact that the drilling hardware is inaccessible for subsequent cleaning make stringent bacterial cleanliness requirements such as those implemented in space research unrealistic.

The hydrodynamic nature of subglacial aquatic environments facilitates cell transfer from any object that may find its way into liquid water. If the lake has unique biological ecosystems, transfer may also occur as a robotic sampling device moves from ecosystem to ecosystem. In general, requirements for cleanliness will have to be addressed in terms of (1) cleaning hardware (quantification of bacterial levels and bacterial diversity present) prior to penetration, (2) maintaining hardware cleanliness as much as possible during penetration, and (3) designing research techniques that minimize the possibility of cell transfer between different levels in the ice and the lake bed itself. **Specific decontamination techniques need to be developed for any instruments deployed in a subglacial aquatic environment.** The current decontamination approaches include sterilization by heat (autoclave) and/or chemical treatment (peroxide). The instrument packages must be robust to maintain their operational specifications following these decontamination protocols.

A critical aspect of subglacial lake exploration and technology development is testing, verification, and monitoring of potential contamination during all phases of the scientific program. There must be deliberate and careful scrutiny of the methodologies employed, from ice drilling to sample recovery, from both an environmental stewardship and a scientific standpoint. Stewardship issues include providing the maximum possible protection of subglacial lake environments by ensuring minimal alteration or change due to the planned scientific studies. From a scientific standpoint, it is essential that uncompromised samples be provided for study and that the presence of human-made devices does not bias the data collected. There is also concern that unusual or previously unknown biological agents be properly handled upon retrieval to avoid an unwanted release to the environment.

## 5

## Antarctic Governance and Implications for Exploration of Subglacial Aquatic Environments

### ANTARCTIC TREATY

The Antarctic Treaty arose from the success of the International Geophysical Year (IGY) 1957-1958, which had the scientific exploration of the Antarctic as one of its chief objectives. The scientific success of the IGY persuaded the international scientific community to encourage politicians to find a way to ensure that Antarctica remained open for future scientific work by all. The treaty was signed in 1959 by the 12 state parties active in the Antarctic during the IGY and ratified in 1961. It has no termination date and is open to signature by any state with an interest in its objectives. To date, an additional 33 states have acceded to the treaty, and a number of others are observers at the annual meetings prior to making a decision to join.

The Antarctic Treaty has two classes of state membership—Consultative Parties and Acceding Parties. The original 12 countries were classed as Consultative Parties, states that had declared a substantive and active interest in the Antarctic and were undertaking continuing scientific research there. Such states form the core of the treaty and determine its development by agreeing to international legislation. They also have a vote at the annual meeting, and since the business proceeds by consensus, disagreement with any proposal by a Consultative Party effectively stops further progress.

Acceding Parties agree with the principles of the treaty but are not actively involved in Antarctic work. They have no vote at the treaty meetings but may attend and comment on papers and discussion. In addition to the state parties there are three observers—the Scientific Committee on Antarctic Research (SCAR), Council of Managers of National Antarctic Programs (COMNAP), and the Commission for the Conservation of Antarctic Marine Living Resources (CCAMLR)—and a wide range of experts who have to be formally invited to attend the meeting and whose rights at the meeting are restricted.

The Antarctic Treaty Consultative Meetings (ATCMs) take place every year, normally rotating through the Consultative Parties alphabetically by country name in English. The meetings last two weeks, of which the first week is devoted to a meeting of the advisory Com-

mittee for Environmental Protection as well as a legal group, while the second week is devoted to Plenary sessions and parallel meetings of three Working Groups: Operational Matters; Tourism; and Non-governmental Matters, Legal and Institutional.

As well as an agreed report from the Plenary the legal outcomes of an ATCM are measures, decisions, and resolutions. The agenda is structured around working papers (in four languages), which can be submitted by Consultative Parties and observers, and information papers, which can be submitted by any parties, observers, or experts. The convention is that all working papers must have substantive discussion while information papers are discussed only by request. Discussions at all official committees of the ATCM must take place with simultaneous translation into English, French, Spanish, and Russian, which have been the four working languages of the Antarctic Treaty since its ratification.

Science discussions may take place in any of the working groups of committees, but they are principally restricted to the Committee for Environmental Protection (CEP) and the Operational Matters Working Group. Subglacial lakes have been on the agendas for both of these groups for several years. Although there may be some overlap in discussions, the demarcation is generally clear, with issues of environmental protection, management, and pollution going to the CEP and reports on the science from the lakes going to the Operational Matters Working Group.

Establishment of the CEP was part of the adoption of the Protocol on Environmental Protection to the Antarctic Treaty in 1991. The protocol systematically reorganized all the previously agreed instruments on the environment and conservation and with its six annexes now provides the most substantive focus for annual discussions at the ATCM. Annex V to the protocol contains the provisions for area protection and management.

## PLANETARY PROTECTION AND THE OUTER SPACE TREATY

A comparison between planetary protection for the solar system and environmental stewardship of Antarctic environments reveals a number of similarities, ranging from the basic governances to their science-driven policies as well as the similar approach to oversight and review of individual projects by designated government institutions. The comparison also reveals some important differences in how revisions are made at the international level.

Planetary protection (PP) refers to the name given to the policy of the international Committee on Space Research (COSPAR) and the U.S. National Aeronautics and Space Administration (NASA) aimed at preventing biological contamination of other worlds (forward contamination) and avoiding potential contamination of Earth by returned extraterrestrial materials, referred to as back contamination (NASA 1999; COSPAR 2002; Rummel 2006).

Planetary protection has been a topic of concern since the earliest years of space exploration and was part of international deliberations for the Outer Space Treaty even before the launch of Sputnik. Initially signed in 1967, the Outer Space Treaty was ratified and has been acceded to by 98 nations over the years. With underlying concepts drawn from the earlier Antarctic Treaty, the Outer Space Treaty prohibits the placement of nuclear or other weapons into orbit, forbids the militarization of space, and asserts that the use and exploration of outer space will be guided by cooperation and mutual assistance, used exclusively for peaceful purposes, and done in a way that avoids harmful contamination of celestial bodies and adverse changes in the environ-

ment of the Earth (Article IX of the Treaty). The Outer Space Treaty has no termination date and is open to signature by any state with an interest in its objectives. Any state party to the treaty can propose amendments to it, which must be accepted by a majority of the states—unlike the Antarctic Treaty, which requires consensus for every decision. Again unlike the Antarctic Treaty, there is no distinction in the types of parties or member states involved in the Outer Space Treaty, regardless of whether they are actively involved in space exploration and/or launched missions.<sup>1</sup>

In addition to being centered on a treaty for its framework, planetary protection is interpreted and applied through designated international scientific bodies. In the final analysis, the application of planetary protection is like the Antarctic Treaty in that implementation depends on a political and legal forum in which science plays an advisory role—and the “launching state” is responsible for compliance. Historically, the technical aspects of planetary protection are developed through deliberations by COSPAR, which is part of the International Council for Science (ICSU) and is consultative to the United Nations in this area.

In recent years, planetary protection policy for solar system exploration missions has been developed by the member nations of COSPAR through its Panel on Planetary Protection (PPP). The PPP is responsible for developing, maintaining, and promulgating PP knowledge, policy, and plans to avoid harmful biological contamination of other worlds by terrestrial organisms and to avoid the potential contamination of Earth by returned extraterrestrial materials. (NASA 1999; COSPAR 2002; Rummel 2006). The COSPAR PPP accomplishes its work through symposia, workshops, topical meetings, and business meetings at the COSPAR Scientific Assembly held every two years. In this way, the PPP is able to act as an international forum for the discussion and exchange of information related to planetary protection (PP), and to deliberate over implementation concerns or needed revisions in policies based on updated scientific information. Recommendations and decisions arising from PPP meetings are submitted to the COSPAR Bureau for official consideration, with final approval subsequently subject to decisions by the COSPAR Council before they may take effect.

In the United States, NASA oversees the application of procedures and guidelines under a policy directive (NASA 1999) aimed at ensuring compliance with COSPAR planetary protection policy. NASA also undertakes regular interaction with the scientific community and may request recommendations on specific issues from the Space Studies Board (SSB) of the U.S. National Research Council (NRC). The NRC is an operating arm of the U.S. National Academies and is the U.S. member institution and adhering body to COSPAR. Due to the accelerating pace of solar system exploration, NASA's Advisory Council (NAC) also chartered a Planetary Protection Advisory Committee in 2002, (now a NAC subcommittee) for internal advice on planetary protection matters. Table 5.1 provides a direct comparison of key governance and policy features for exploration of both the solar system and Antarctica. Table 5.2 discusses review processes for individual research proposals.

The current COSPAR and NASA PP policy uses a classification system for individual projects based on four categories (I-IV), each of which is determined by a combination of both the intended target body and the type of mission and activities planned.

---

<sup>1</sup>A country can be involved in exploration either by launching its own missions or by a research partnership on another country's mission. The country launching the mission must comply with the PP regulations and ensure that its research partners are in compliance.

TABLE 5.1 Comparison of Governance and Policy

	Solar System Policy and Governance	Antarctic Policy and Governance
Treaty	United Nations Outer Space Treaty (OST), (1967) No meeting provided for since signed. Contamination sections of the treaty effectively managed by a scientific body as a consensus agreement among signatories	Antarctic Treaty (1959) Meets every year and manages the continent directly through regulation
Overall goals	OST Article IX: Signatory states will conduct exploration of planetary bodies “so as to avoid their harmful contamination and also adverse changes in the environment of the Earth resulting from the introduction of extraterrestrial matter, and where necessary, shall adopt appropriate measures for this purpose”  <i>Interpreted Major Concerns:</i> Avoid harmful cross-contamination and preserve organic constituent values for scientific exploration; avoid forward and <i>backward</i> contamination (either unintentional or deliberately transported materials), and maintain the integrity of the environment for scientific study in the short and long term for all humankind	Article 3 of Protocol on Environmental Protection to the Antarctic Treaty: Parties commit themselves to “protection of the Antarctic environment and dependent and associated ecosystems and the intrinsic values of Antarctica, including its wilderness and aesthetic values and its value as an area for the conduct of scientific research”  <i>Interpreted Major Concerns:</i> Encourage good governance, good stewardship, good practices, international cooperation. Minimize conflict based on scientific information; protect resources by good practices; maximize scientific utility of data and encourage exchange of information. In practice, avoid introduction of exotic organisms (forward contamination). Maintain resources for conduct of scientific exploration and other values for humankind
Responsible organizations for scientific advice related to policies and practices	<i>International:</i> COSPAR via Panel on Planetary Protection (PP), which makes recommendations to COSPAR Council and Bureau  <i>United States:</i> NASA Planetary Protection Office (PPO) oversees PP policy and implementation within NASA; assigns requirements to solar system missions; has rule- and decision-making authority regarding implementation of PP controls on U.S. missions; updating of policies and controls in consultation with the scientific community  NASA obtains internal advice from the NASA Advisory Council/ Subcommittee on PP (formerly PP Advisory Committee); also requests recommendations from the NRC Space Studies Board as needed NASA implements international PP cooperation on joint missions by bilateral agreement with its partners, citing COSPAR policy as governing PP implementation on the mission	<i>International:</i> SCAR SALE (Subglacial Antarctic Lake Exploration), which make recommendations to the Committee for Environmental Protection  <i>United States:</i> National Science Foundation (NSF), Office of Polar Programs. NSF Environmental Office manages the U.S. Antarctic Program and administers the Antarctic Conservation Act of 1978 and its permit system (Oversees EIA's and CEE's for U.S. governmental projects). (NRC is the U.S. member institution in SCAR)  NSF obtains advice from the scientific community and the NRC Polar Research Board; there is an ongoing management relationship between NSF and the research community based on grant funding

*continued*

TABLE 5.1 Continued

	Solar System Policy and Governance	Antarctic Policy and Governance
Current guiding policy	<p>The current PP policy is applied through a mission classification system based on five categories determined by a combination of both target body and mission type (Categories I-V). The assigned category level depends on the degree of contamination concern for the celestial body and its importance for future science exploration related to chemical evolution and origin of life. An appendix to the policy includes the specific categories assigned for different bodies, as well as implementation guidelines and specified requirements for individual target bodies including Mars, Europa, and small solar system bodies (COSPAR 2002)</p> <p>Current PP practices for U.S. missions to Mars and elsewhere in the solar system incorporate all the revisions to COSPAR policy through 2002. NASA continues to work with COSPAR and the international community to consider whether and how policies and associated implementing regulations should be revised to reflect rapidly changing information about extraterrestrial environments and microbial life</p> <p><i>Perspective Regarding Microbes:</i> From inception, microbes have been a priority focus of COSPAR policy under the Outer Space Treaty, a perspective likewise shared by implementing bodies and space agencies. NASA's implementing policy and practices aim at minimizing microbial and organic contamination, adopting appropriate cleanliness levels and microbial reduction methods, utilizing pre-launch microbial assays and verification, and requiring routine documentation of implementation consistent with stated international policy</p>	<p>Protocol on Environmental Protection (1993) outlines plans, designations, and permits for area protection and management (including creation of designated Antarctic Specially Protected Areas, and Antarctic Specially Managed Areas [ASMAs]) and the minimization of impacts from waste or pollution</p> <p>Test for importance of impact is minor and/or transitory with no definitions of either terms. Microorganisms are only addressed in Annex II article 4 of the protocol to prevent introductions of nonnative species</p> <p><i>Perspective Regarding Microbes:</i> The focus has largely been on macroscale environmental impacts (e.g., wastes; pollution; introduction of exotic animals, plants, soils, or pathogens; reversible actions). Concerns about microbial contamination (other than by disease) or perturbation of microbial habitats have been little addressed, with a few exceptions (e.g., McMurdo Dry Valleys ASMA)</p>

NOTE: CEE = comprehensive environmental evaluation; EIA = environmental impact assessment.

TABLE 5.2 Review Processes for Individual Exploration or Research Proposals

	Solar System Exploration	Antarctic Exploration
Relevant review processes for individual missions or proposals	<p>Assignment of mission to appropriate PP category by Planetary Protection Office (PPO); develop and submit PP plan for mission activities. PP plans and approval required well in advance of mission; approvals and exceptions issued by NASA PP officer</p> <p>As required, missions may also involve other legal or regulatory reviews beyond PP reviews (e.g., presidential review under Presidential Directive-National Security Council-25<sup>d</sup> for alleged global impacts or use of nuclear materials; environmental impact reviews under NEPA)</p> <p>Mission information on PP compliance is regularly conveyed to COSPAR and the international community, but no formal international review is required</p>	<p>Routine pre-project reviews by NSF via EIA (consider activity, resources, and alternates; identify and evaluate potential impacts, mitigation, etc.). EIA documents and NSF approval are required prior to initiation of field activities. NSF may issue approval on its own if impacts are deemed to be minor or transitory</p> <p><i>Impacts Greater than Minor and/or Transitory:</i> CEE and international review and comment by Antarctic Treaty Consultative Parties are required prior to initiation of activity</p>
Required components of project plans	<p>According to policy, PP plans must include: information on target or mission category; technology and operational plans; specific plans for meeting required cleanliness levels, including use of standard bioload reduction methods, assaying, and monitoring contamination during ATLO; details on recontamination avoidance procedures and plans; archiving of organic inventory and samples; calculations of probability of crashes and quantification of total outbound spacecraft bioload; schedule of documentation and required reports</p>	<p>Until recently, the main focus of project reviews has been on macroscale environmental concerns (waste, pollution, introduced vs. native flora and fauna, reversibility of impacts, etc.). The typical EIA includes description of activity including purpose, location, duration, and intensity; consideration of alternatives and any impacts (including cumulative ones) likely from activity. In addition, for a CEE, descriptions of initial environmental state, measures and monitoring programs to detect impacts, consideration of effects on science and other values, and an identification of gaps in knowledge are also required. The legislation provides no recommended methods or standards for any activity</p> <p>With respect to projects exploring subglacial aquatic environmental systems, currently there are no standards for cleanliness or monitoring methods; nor is there any required implementation guidance regarding contamination control during staging, operations, or sample collection. There are no specific monitoring or archiving requirements related to microbial contamination. There is no indication of what contamination concerns and controls apply to different stages of exploration or in different locations</p>

NOTE: ATLO = assembly, test and launch operations; CEE = comprehensive environmental evaluation; EIA = environmental impact assessment; NEPA = national environmental policy act.

<sup>d</sup>Presidential Directive/National Security Council-25 (December 14, 1977). Scientific or Technological Experiments with Possible Large-Scale Adverse Environmental Effects and Launch of Nuclear Systems into Space.



Category V is indicative of an Earth-return mission. Details on historical and current PP COSPAR and NASA policies may be found in a recent NRC report on the forward contamination of Mars (NRC 2006). Specific information on the review of proposed projects under NASA guidelines and management directives may be found on NASA's planetary protection web site ([www.planetaryprotection.nasa.gov](http://www.planetaryprotection.nasa.gov)).

## MANAGEMENT GOALS FOR GOOD STEWARDSHIP

The Antarctic community, which has seen environmental management rules undergo numerous revisions in policies and requirements over the decades, is now facing the need to address a new science exploration dilemma. What policy, environmental classifications, management scheme, cleanliness levels, and methods should be adopted for the newly discovered and unique subglacial lake and other aquatic environments with its associated ecosystems and how can this be done within the existing legislation? Even though there are some crucial differences in approach, drawing on PP protocols and past experiences in shaping policy may be a useful way to develop a preliminary framework for addressing subglacial aquatic management and contamination control. Ideally, such a framework would link particular concerns and tasks with the appropriate level of the policy or implementation process, as well as identify the relevant responsible groups and utilize their respective expertise.

### Minimizing Environmental Impacts

As part of the environmental principles laid out in Article 3 of the protocol there is a requirement that activities in the Antarctic Treaty area be subject to prior assessment of their possible impacts on the Antarctic environment and on associated and dependent ecosystems. Article 8 amplifies this by setting out three levels of possible impact, based on predicting whether the activity will produce a greater or lesser impact than "minor or transitory," and Annex I details the procedure that should be followed in determining the impacts, possible mitigation, and necessary monitoring. In short, if the impacts are judged less than minor or transitory, this constitutes a preliminary assessment and the activity can be authorized without further restriction or consultation. If the impacts are judged to be minor and/or transitory, an Initial Environmental Evaluation (IEE) is required, which must follow the required procedures but is not subject to international assessment, although the CEP should be notified at its next meeting and the IEE should be available on request. Where the impact is expected to be more than minor and/or transitory then a full Comprehensive Environmental Evaluation (CEE) is required. This is a major undertaking and uses a two-stage procedure. The first stage is a draft that must be made publicly available and circulated to all parties at least 120 days before the next ATCM. The CEP provides the forum for the discussion of this draft CEE and any comments on it. A final version of the CEE must then be prepared, addressing the comments made, and again circulated to all parties at least 60 days before the commencement of any activity in the Antarctic. As with all activities required under the treaty, the initiative and responsibility both for preparing the CEE and for implementing it rest entirely with the sponsoring party.

This procedure applies to all parties, but these are not binding despite the development of detailed procedural guidelines based on Annex I and approved as Resolution 1 by the XXIII ATCM in 1999. There is wide variation in the enthusiasm with which the

assessments are undertaken, the independence of the reviewers or authorizing committees (where they exist) in national systems, and crucially, the interpretation of the terms “minor” and “transitory.” Several attempts have been made to reach agreement on how these terms could be applied uniformly, but without success. A survey of practice so far has indicated a general level of agreement for many types of activity but there are clearly significant differences between parties in the decision to determine that an activity requires a CEE rather than an IEE. There has been general agreement that major infrastructure development such as building or rebuilding a station or a permanent runway requires a CEE, and this has been followed by, for example, the United States for the rebuilding of the South Pole, the United Kingdom for the rebuilding of Halley, and Germany for the rebuilding of Neumayer. For scientific work, Germany undertook a CEE in 2000 for deep ice coring and New Zealand provided one in 2003 for Antarctic Geological Drilling (ANDRILL) sediment coring in the Ross Sea. As far as subglacial lakes are concerned, the Russian Federation introduced a draft CEE in 2002 detailing its proposals to penetrate the lake in due course and provided an IEE later for an interim development to deepen the drill hole in advance of penetration. It seems likely that if the project to drill into Lake Ellsworth is funded the sponsoring parties will require a CEE before drilling is allowed to proceed.

### Preservation

The Antarctic Treaty has made provision since 1964 for the protection of sites. Initially this was to protect scientific interests and such areas were designated Sites of Special Scientific Interest to avoid conflicting uses that could jeopardize the science. It was then recognized that there was also a need to designate sites for conservation objectives. Initially these were designated Specially Protected Areas and were used to conserve key examples of the diversity of habitats found on and around the continent. These two categories were unified as Antarctic Specially Protected Areas (ASPAs) in Annex V of the protocol, with their different purposes being distinguished in the details of their management plans.

Designation as an ASPA provides mandatory international protection for a site with the management plan, restricting what activities can be undertaken, and a requirement for all parties to report to whom they issued permits for access and for what reason. For sites designated for research purposes this should provide a clear record of activities undertaken by scientists of any party. For sites designated for conservation purposes, it should provide long-term protection from contamination. The geographical basis for the application of the category ASPA in this instance will need further discussion because the recognition of interconnectedness in the subglacial aquatic environment may require the designation of a buffer zone comprising a part or the whole of a watershed in order to ensure that activities higher up the gradient do not inadvertently contaminate the protected area.

Annex V provides the methodology by which special protection can be granted for specific areas of the Antarctic. In Article 3 of the annex there is a list of nine categories of area that parties are enjoined to consider. Among these are:

- areas to be kept inviolate from human interference;
- representative samples of major terrestrial ecosystems, including glacial and aquatic, and marine ecosystems;

- areas of particular interest to ongoing or planned scientific research; and
- areas of outstanding geological, glaciological, or geomorphological features.

Although no subglacial lake has so far been proposed as an ASPA, the legislation would allow one or several to be so designated under the categories listed above. Such a proposal could be put forward by any Consultative Party or by SCAR.

### Managed Scientific Research

Exploring subglacial aquatic environments, and especially lakes, is an activity that is expected to begin, and grow, in the coming years. The pursuit of scientific knowledge needs to be balanced against cleanliness, yet it is expected that as technology develops, so will the ability to sample more cleanly and explore these lakes. As a simple rule, exploration of these lakes should always be conducted with the cleanest technology possible.

However, the relatively high number of known subglacial lakes affords the possibility of designating lakes for different kinds of exploration, recognizing that one type of investigation may undermine other types of science in that particular lake. For example, remotely operated vehicles or probes could be released into a lake to measure and transmit back physical properties of the lake such as temperature, water current velocities and directions, and salinity. Such probes may not be held to the highest standards of cleanliness that would be required of sampling microbes, probably making the lake unsuitable for microbiology.

It is important that lessons learned in exploring a particular lake be transmitted quickly and effectively to the broader scientific community and that all progress in this field be adequately documented for each site. In this way, technology can advance as quickly as possible. Also, the issue of the interconnectedness of lakes, which if high could restrict the exploration strategy or if low would open the exploration strategy, needs to be carefully monitored and updated.

### CONCLUSIONS

In approaching subglacial aquatic research in the immediate short term, the practical imperatives of the Antarctic Treaty—scientific collaboration, logistic cooperation, and the free exchange of data—provide an unrivaled framework for planning and development. There are important scientific goals to achieve in a difficult and expensive operating environment where jointly planned international activities will maximize the value to all humankind while ensuring that the latest technology is available to pursue these objectives. Evidence from deep ice core drilling shows just how effective this approach can be.

To ensure that the best possible advice was available to all countries interested in subglacial lakes, SCAR established a Group of Experts (which now has 14 specialist members from nine countries) and publishes its workshop outputs online. Research into the subglacial lakes is now one of the five major programs adopted by SCAR for the next 5-10 years, and details of research proposals are on the SALE (Subglacial Antarctic Lake Exploration) web site at [http://salepo.tamu.edu/scar\\_sale](http://salepo.tamu.edu/scar_sale). This web site also provides links to both the International Polar Year (IPY) SALE UNITED (Unified Team for Exploration and Discovery) project, which lists all the proposed subglacial

aquatic initiatives agreed under IPY, and to the U.S. SALE group, which lists all the interested scientists and engineers in the United States.

In deciding how to treat all subglacial aquatic environments in the future, it is prudent to recognize that at least some examples of lakes should be conserved inviolate for future generations. At present, the detailed information that exists about all lakes except Lake Vostok is very limited, and it is both possible and likely that more lakes will be identified in due course in areas of the continent for which very limited or no radio echo-sounding data currently exist. It is beyond the scope of this investigation to suggest how the examples for conservation should be chosen or the extent of the data necessary to characterize them before proposing protection. However, it is reasonable to suppose that research and science using future technology will be better applied to inviolate examples, which puts a premium on selecting the examples for conservation as soon as practicable.

## 6

## Findings and Recommendations

Beneath the Antarctic ice sheet, water has accumulated over millennia, forming watery subglacial environments. Using both airborne and surface radar, researchers have now identified more than 145 subglacial lakes, the largest being Lake Vostok with a surface area of 14,000 km<sup>2</sup>, similar to that of Lake Ontario. Radio-echo sounding data also suggests that shallow, swamp-like features the size of several city blocks and water-saturated layers of soils or broken rocks may exist beneath the ice sheet, giving rise to a wide range of subglacial aquatic environments beyond just the large lakes. These features formed in response to a complex interplay of tectonics, topography, climate, and ice sheet flow over millions of years and remain virtually unexplored. They may have been sealed from free exchange with the atmosphere for millions of years, making it possible that unique microbial communities exist in these systems. Recent evidence shows that many of the subglacial aquatic environments comprise vast watersheds connected by rivers and streams that flow beneath the ice sheet.

Most of our current knowledge about the lakes and other subglacial aquatic environments is derived from interpretations of remote sensing data and chemical and biological analyses of samples of Lake Vostok water that froze to the bottom of the overlying Antarctic ice sheet (accretion ice). Although much can be learned about subglacial environments from remote sensing and ice core data, many of the key questions about these systems require that samples of water, microbial communities, sediments, and underlying rock be obtained. No one has yet drilled into a lake; thus, the next challenge in the exploration of subglacial aquatic environments is to determine the best way of drilling into, sampling, and monitoring these environments.

### TOWARD EXPLORATION OF SUBGLACIAL ENVIRONMENTS

The possibility of the existence of subglacial water was first identified in 1968 from airborne radio-echo sounding data (Robin et al., 1970). Several years later, the first subglacial lake was reported beneath Sovetskaya Station, and data suggested the presence of water under Vostok Station. In 1974-1975, an airborne radio-echo survey of ice depths over central

East Antarctica near the Vostok Subglacial Highlands led to the discovery of a sub-ice lake with an area of about 10,000 km<sup>2</sup>, lying underneath almost 4 km of ice and apparently close to Vostok Station. In 1993, altimetric data from satellite measurements provided independent evidence of the areal extent of Lake Vostok, thus confirming it to be the largest known sub-ice lake.

Momentum to begin direct sampling of subglacial aquatic environments has built over the last decade, and this objective has sparked a great deal of scientific interest in and debate on how to overcome the challenges associated with cleanly drilling and cleanly sampling these unique environments. In response to this debate, the Scientific Committee on Antarctic Research (SCAR<sup>1</sup>) constituted a group for Subglacial Antarctic Lake Exploration (SALE), composed of scientists from SCAR member nations, and charged the group to begin a process of discussion and collaborative planning. The SCAR SALE group has provided international organizing and planning for the exploration of subglacial aquatic environments. The main objectives of the SCAR SALE program are to understand the formation and evolution of subglacial lake processes and environments; to determine the origins, evolution, and maintenance of life in subglacial lake environments; and to understand the limnology and paleoclimate history recorded in subglacial lake environments. One of the key scientific questions posed in the SCAR SALE program is concerned with the origins, evolution, and maintenance of life in subglacial aquatic environments. The SCAR SALE group speculated that life in subglacial lake environments could be unique; thus, any attempt to sample the water, sediment, or organisms directly should ensure that the subglacial aquatic environment is not contaminated, especially by carbon substrates that might allow the aquatic ecosystem to change fundamentally. The SCAR SALE group recommended an integrated science plan for the future to ensure that one type of investigation does not accidentally impact other investigations adversely; that sampling regimes plan for the maximum interdisciplinary use of samples; and that all information is shared to promote greater understanding. The SCAR SALE group continues to foster international coordination and collaboration; however, the group has not examined stewardship issues in depth.

Currently, no clear protocols for environmental stewardship or standards for minimizing contamination have been established for subglacial aquatic environments beyond the general guidelines of the Antarctic Treaty. This is critical because exploration of these environments is proceeding. Preparations for sampling Lake Vostok are well advanced; plans to explore subglacial Lake Ellsworth have been circulated through the international community; and two other subglacial aquatic environments are under consideration. The committee did not debate whether or not these plans should proceed and recognizes that these investigations are part of national science initiatives.

---

<sup>1</sup>SCAR is an interdisciplinary committee of the *International Council for Science (ICSU)* charged with initiating, developing, and coordinating high-quality international scientific research in the Antarctic region and the role of the Antarctic region in the Earth system. The scientific business of SCAR is conducted by its *Standing Scientific Groups*, which represent the scientific disciplines active in Antarctic research and report to SCAR. In addition, to its primary scientific role, SCAR provides objective and independent scientific advice to the *Antarctic Treaty Consultative Meetings* and other organizations on issues of science and conservation affecting the management of Antarctica and the Southern Ocean. In that role, SCAR has made numerous recommendations about a variety of matters, most of which have been incorporated into Antarctic Treaty instruments. Foremost among these has been the advice offered for the many international agreements that provide protection for the ecology and environment of the Antarctic. SCAR has national representation from those countries with an active scientific interest in Antarctica.

Both Russian-led and U.K.-led consortia have followed the current protocols for scientific research on these lakes and have addressed issues brought forth through the Antarctic Treaty Protocol. These groups have had discussions with SCAR SALE and have satisfied their respective national science protocols. The purpose of this study is to provide independent guidance on how to minimize contamination of subglacial lake environments during exploration and how to provide responsible stewardship of these unique and possibly connected environments.

### NEXT STEPS IN SUBGLACIAL EXPLORATION

Although no lake has been sampled directly, Lake Vostok has been studied using remote sensing, chemical analyses of ice accreted to the bottom of the Antarctic ice sheet, and geochemical modeling. Results of these analyses suggest that the upper waters in the lake have a low salinity and possibly extremely high concentration of gases such as oxygen. Lake Vostok has been isolated from the atmosphere for more than 15 million years (Christner et al. 2006); the water, which flows very slowly through the system, is estimated to reside in the lake on the order of tens of thousands of years.

There is some controversy in the peer-reviewed literature whether or not there are microorganisms living in Antarctica's subglacial lakes. The controversy is due mainly to the fact that there are currently no samples of lake water, only accreted ice. Based on published reports, the number of microbial cells in the accreted ice of Lake Vostok may be as high as 10,000 or as low as a few recognizable cells per milliliter. The water may also contain low levels of microbial nutrients, necessary to support microbial communities; estimates of dissolved organic carbon (DOC) concentrations range from undetectable to 250  $\mu\text{mol L}^{-1}$ , the latter being well above concentrations in the open ocean (typically about 70  $\mu\text{mol L}^{-1}$ ).

It should be noted that many types of microbes, including bacteria, yeasts, and fungal spores, are found in low abundances within the ice sheet and some of these microbes may still be viable as they enter the subglacial aquatic environment. These liquid-water systems may also contain low levels of microbial nutrients. As a result, despite the pressure and temperature regime of the subglacial environment, there is a possibility of microbial metabolism and growth. Rates of both growth and evolution are expected to be slow in these environments.

Microbial cells and organic nutrients may be heterogeneous from sample to sample, but until a fresh sample of water is collected using precautions to avoid chemical and microbiological contamination, we will not know for sure. Even when freshly collected samples are available, it will be important to certify all measurements preferably by cross-calibrated measurements from several independent laboratories. Chemically, subglacial aquatic environments can be expected to vary widely from site to site, and the complete absence of viable microbes cannot be excluded until adequate sampling is done. However, from a scientific perspective, extreme oligotrophic environments are themselves unusual, interesting, and worthy of study.

In light of potential, adverse consequences for environmental stewardship, the committee favors a conservative approach where it is assumed that actively growing microbial populations in the subglacial environments are present until proven otherwise. Current understanding of the sub-ice habitat and its inhabitants is based entirely on indirect observations that range in scope from theoretical predictions to direct chemical and microbiological analyses of accreted ice samples obtained from Lake

Vostok. Consequently, the committee considers the identity and diversity of life, the nature of the electron donors and acceptors to support life (if life exists), and all other related ecological and biogeochemical properties as fundamental, but unanswered, questions.

Despite the initial investigations of Lake Vostok, great uncertainty remains about many basic physicochemical parameters, such as salinity and concentration of dissolved gases, especially in the deeper waters of the lake. Another problem is that the accreted ice excludes all gases, most of the dissolved material, and many of the particles when it froze. We do not know the partition coefficients for ice forming under these conditions. Thus, we cannot yet determine the chemical and microbial concentrations of the lake water by analyzing chemical and microbial concentrations in the ice accreted above the lake surface. In addition, questions about the presence of microbial populations and about their growth, diversity, and uniqueness cannot be answered until the subglacial waters and sediments are sampled directly.

There is great value in setting the exploration of subglacial aquatic environments in motion now. These unique environments may hold critical information needed to answer many questions about microbiological life, evolution, and adaptations; Antarctic and global climate over the past 65 million years; ice sheet dynamics; and the evolution of subglacial aquatic environments and their associated hydrological and biogeochemical processes. Scientific interest in the subglacial hydrology of ice sheets has become increasingly important, because we need to learn as much as possible about how the subglacial water system operates beneath ice sheets. The question of whether ice sheets can have a large dynamic response to changes at their margins (e.g., the breakup of ice shelves) partly involves the question of whether or not fast flow processes will be activated by changes in subglacial conditions. Thus, there are conceivable links to the important question of sea level rise. It is important for us to acquire this information in the next 5 to 10 years—not several decades from now.

During the Vostok investigation (Box 1.1), data will be gathered that may help determine whether microbial life is present or absent from this environment. Chemical analyses of water samples will help spark speculative discussions about partition coefficients, which will improve geochemical modeling of these environments. Plans for the exploration of Lake Ellsworth (Box 1.2) include physicochemical and biological measurements and water and sediment sample recovery. The results of both of these investigations will only begin to develop an initial understanding of these environments, but these first samples will provide all-important evidence about how conservative we should be in moving forward. From a scientific perspective, the data and lessons learned from these endeavors should be used to guide future environmental stewardship, scientific investigations, and technological developments.

The pursuit of scientific knowledge, however, needs to be balanced against environmental stewardship and cleanliness. Responsible stewardship during the exploration of subglacial aquatic environments should proceed in a manner that minimizes the possible damage to these remarkable habitats and protects their value for future generations, not only in terms of their scientific value but also in terms of conserving and protecting a pristine, unique environment. This is particularly important because it now appears that these environments are hydrologically and potentially biologically connected and that activities at one site may affect other sites within the system.



The international system of governance through the Antarctic Treaty system<sup>2</sup> works by consensus whereby all signatory nations must agree on changes in regulations and protocols. This unique system provides perhaps the best global forum in which to agree and implement the concept of stewardship. The Protocol on Environmental Protection to the Antarctic Treaty provides a coherent framework for conservation and environmental management. Antarctic Specially Protected Areas (ASPAs) have been established in many areas of the continent to legally protect the vegetation or the fauna for both scientific and conservation reasons.

Subglacial lake environments can be managed under existing approaches, whereby these environments are designated according to the Antarctic Treaty as “resources in need of special protection either for scientific research or conservation purposes.” Under this designation, subglacial aquatic regions selected for “scientific research” would have management plans that dictate the range of permitted investigations and ensure, through permitting and reporting requirements, that an audit trail exists of all the research undertaken. Lakes or subglacial regions designated for “conservation” would be set aside to conserve untouched examples of the diversity of subglacial aquatic environments for future generations

In addition, the Committee for Environmental Protection (CEP) oversees the Comprehensive Environmental Evaluation (CEE) of proposed activities that are predicted to have more than a minor and/or transitory impact on the Antarctic environment. Steps within the regulatory framework of the Antarctic Treaty expose the proposals to a wide range of expert comment and ensure that the scientific community uses best-available practices. The requirement inherent in the treaty protocol to review the management plans every five years will provide the opportunity to assess how well these designations are working.

In the exploration of subglacial aquatic environments, there are important scientific goals to achieve in a difficult and expensive operating environment. Jointly planned international activities will maximize the value of this research while ensuring that the latest technology is used. A multinational approach will bring the widest range of expertise to bear and, by focusing research efforts, reduce the number of subglacial aquatic environments investigated, thereby reducing the impact of science research on these remarkable resources. This international cooperation would also be consistent with the terms of the Antarctic Treaty, specifically the agreement by all signatory parties “to endeavour . . . to promote cooperative programs of scientific, technical and educational value, concerning the protection of the Antarctic environment and dependent and associated ecosystems” (Article 6 of the Protocol on Environmental Protection to the Antarctic Treaty, the Madrid Protocol).

---

<sup>2</sup>The governance of Antarctica is guided by the Antarctic Treaty, which came into force in on June 23, 1961. The Antarctic Treaty system includes a series of agreements that regulate relations among states in Antarctica. Under the treaty, 45 signatory countries have agreed to protect the relatively unspoiled environment of Antarctica and its associated ecosystems; preserve and pursue unique opportunities for scientific research to understand Antarctica and global physical and environmental systems; maintain Antarctica as an area of international cooperation reserved exclusively for peaceful purposes; and ensure the conservation and sustainable management of living resources in the oceans surrounding Antarctica.

**Recommendation 1**

*Direct exploration of subglacial aquatic environments is required if we are to understand these unique systems. Exploration of subglacial aquatic environments should proceed and take a conservative approach to stewardship and management while encouraging field research.*

**Recommendation 2**

*Exploration protocols should assume that all subglacial aquatic environments contain or may support living organisms and are potentially linked components of a subglacial drainage basin.*

**Recommendation 3**

*As soon as adequate survey data have been gathered to provide a sound basis for description, all subglacial aquatic environments intended for research should be designated Antarctic Specially Protected Areas to ensure that all scientific activities are managed within an agreed international plan and are fully documented.*

**Recommendation 4**

*As soon as adequate survey data have been gathered to provide a sound basis for description, actions should be taken to designate certain exemplar pristine subglacial environments as Antarctic Specially Protected Areas for long-term conservation purposes.*

**Recommendation 5**

*Multinational projects should be encouraged in the study of subglacial aquatic environments, and all projects aiming to penetrate into a lake should be required to undertake a Comprehensive Environmental Evaluation.*

**Recommendation 6**

*The National Science Foundation should work in conjunction with the U.S. representatives to the Scientific Committee on Antarctic Research and to the Committee on Environmental Protection to involve all Antarctic Treaty nations in developing a consensus-based management plan for the exploration of subglacial aquatic environments. This plan should seek to develop scientific understanding and ensure that the environmental management of subglacial aquatic environments is held to the highest standards.*

**TOWARD ESTABLISHING LEVELS OF CLEANLINESS**

The problem of how to penetrate kilometers of the ice sheet and sample subglacial aquatic environments in the cleanest and least intrusive manner possible remains a considerable technological challenge. Current drilling technologies are not sterile; drilling fluids may contain both microbes and substrates for microbial growth. In addition, the

ice sheet itself contains living microbes, and the extreme climate makes it impossible to carry out drilling without introducing microbes from humans.

The inadvertent introduction of microbes that might grow in these waters is of highest concern. Not only will living microbes potentially alter the aquatic systems, but also exogenous DNA<sup>3</sup> will interfere with research using molecular technology. Accordingly, it is of critical importance to minimize the introduction of exogenous microbes,<sup>4</sup> and even exogenous nucleic acids,<sup>5</sup> to allow for proper investigation of the “true” microbial community (and not contaminants) and prevent changes in microbial communities through the introduction of growth substrates or toxic materials to the subglacial aquatic environment.

Drilling and sampling apparatuses may also add water-soluble oils used in metal working during the fabrication of the instruments and equipment, as well as phthalate ester additives that are used extensively in the plastics industry. The impact of minute quantities of oils and additives may be small and much reduced if they are rapidly diluted by mixing processes in the subglacial environment. Localized effects are possible, however, if mixing is slow; if the mixing volume is small relative to the quantities added; or if the contaminant does not dilute in water (e.g., nonaqueous-phase liquids). It is likely that contamination of subglacial aquatic environments during drilling, sampling, and monitoring cannot be eliminated, only minimized.

Given that some contamination with microbes is inevitable, what level is acceptable? The only known quantity is the number of microbes present in the deep glacial ice. Using this quantity as a baseline, the committee suggests that fluids, drilling, or sampling equipment introduced into the subglacial aquatic environment should not contain more microbes than are present in an equivalent volume of deep glacial ice. From the available evidence, this amount is expected to be a few hundred cells per milliliter. This level of contamination should be considered a provisional rule; when new data become available on microbial populations in these subglacial environments, the standard should be changed to reflect this new information.

Research activities targeting one component of the environment may potentially contaminate or alter another component. For example, sampling may disturb the internal stratification of the lake and change its physical and chemical structure. Sediment sampling may transfer biota from sediments and near-bottom waters to overlying water and ice, which may compromise subsequent measurements of the upper waters and ice. Sediments are likely to contain orders-of-magnitude higher concentrations of microbes, nutrients, and metals than are present in the water column. These benthic microbial communities also are likely to be different from those in the water column. In addition to assessing potential impacts of research activities prior to their start, the committee recognizes the importance of initially sampling sites furthest downstream within a subglacial drainage system to reduce the impact of any contaminants introduced into the drainage system and the importance of maintaining records of materials introduced into the environment to inform future investigations.

Cleanliness requirements for the exploration of subglacial aquatic environments include (1) cleaning hardware (and quantifying microbial levels) prior to penetration, (2) maintaining hardware cleanliness during penetration, and (3) designing research

---

<sup>3</sup>DNA that originates outside an organism.

<sup>4</sup>Microbes that are introduced to closed biological systems from the external world.

<sup>5</sup>Nucleic acids that originates outside an organism.

techniques that minimize the possibility for cell transfer between different levels in the ice and the lake bed itself. If an environment has unique biological systems, transfer may also occur as a robotic sampling device moves between different environments. Thus, it will be important to minimize the level of microbial contaminants on drilling, sampling, and monitoring equipment to ensure that these activities have a minor and/or transitory impact on the environment.

Although there is no definition of minor or transitory in the Antarctic Treaty, in practice, Antarctic Treaty parties have considered the chemical impacts on the Antarctic environment; these considerations may provide a context in which to evaluate potential microbial impacts. The primary concerns surrounding addition of chemicals to the environment have been to determine the contaminant level that can be detected, how long it would continue to be detectable, and what effect the total amount might have on the system. This has been of particular concern for example, in assessing the impact of chemical species in coastal sewage outlets. In practice, if the chemical is not detected, due to dilution, within a short distance from the end of the pipe, then the effect of the contaminant on the environment has been considered as less than minor and transitory. With this definition of minor and or transitory in mind, the committee considers the addition of contaminants which do not change the measurable chemical and/or biological properties in a volume equivalent to the borehole as a less than minor impact. Based on these considerations, the committee offers the following recommendations:

#### **Recommendation 7**

*Drilling in conjunction with sampling procedures will inevitably introduce microorganisms into subglacial aquatic environments. The numbers of microbial cells contained in or on the volume of any material or instruments added to or placed in these environments should not exceed that of the basal ice being passed through. Based on research to date, a minimum of  $10^2$  cells / mL<sup>-1</sup> should not be exceeded, until more data are available.*

#### **Recommendation 8**

*Drilling in conjunction with sampling procedures will inevitably introduce non-living chemical contaminants into lakes and associated subglacial aquatic environments. Toxic and biodegradable materials should be avoided, as should the introduction of nonmiscible substances. At a minimum, the concentrations of chemical contaminants should be documented and the total amount added to these aquatic environments should not be expected to change the measurable chemical properties of the environment. The amount added would be expected to have a minor and/or transitory impact on the environment.*

#### **Recommendation 9**

*Notwithstanding their compliance with Recommendations 7 and 8, investigators should continue to make every effort practicable to maintain the integrity of lake chemical and physical structure during exploration and sampling of water and sediments.*

### EXPLORATION PROTOCOLS

Responsible environmental stewardship for the exploration of subglacial aquatic environments requires investigations to progress from the least invasive techniques to more invasive ones in a stepwise manner. An iterative progression of investigations will generate scientific data while simultaneously providing important information to define standards and protocols that in turn may be refined based on newly acquired data. The ideal approach would be to characterize as many subglacial lake environments as possible using remote sensing and ground seismic sounding and then select examples of different types of environments for progressive investigation. Although the committee recognizes that the ideal approach may be difficult to implement, nonetheless, an incremental approach to and identification of future research sites are strongly suggested.

Once the decision is made to directly sample a particular subglacial aquatic environment, the committee believes that the biology of these environments needs to be protected and is therefore the first priority. Accordingly, good stewardship requires that the cleanest technologies practicable be employed during the exploration of these lakes, and that exploration does not permanently alter the biological and chemical nature of these environments (see Recommendations 7 and 8).

A simple first step would be collection of a water column profile (i.e., using in situ sensors on some kind of profiling package) and a small sample of the water. It is not necessary to sample the environment in its entirety during the initial stages of exploration, because the physical, chemical, and biological properties of the water column need to be understood before realistic standards for contamination can be set and required advancements in engineering for more advanced exploration can be determined. Key data to be acquired in the first step of this progressive approach would ideally be geared toward helping understand partition coefficients, mixing regimes, habitats that have the potential for microbiological activity, and the fate of contaminants. The simplest approach would involve a CTD cast with other sensors, followed by a vertical profile and sample return of water and surface sediment.

Although investigation of Lake Vostok is the most advanced, three other lakes (Concordia, Ellsworth, and South Pole) are under investigation or consideration. These lakes represent different categories based on their geologic characteristics. Vostok is a rift lake, Ellsworth and Concordia are basin lakes, and South Pole Lake may be small and shallow or may consist only of sediments and, therefore, not actually be a lake. The proximity of Vostok, Concordia, and South Pole lakes to existing research stations has great logistical benefits. Although Lake Ellsworth is not located near an existing research station, a reasonable case can also be made for a temporary drilling camp at Lake Ellsworth where a hot-water drill would penetrate the ice sheet in a few weeks (Box 1.2). This site is located along a crevasse-free path to the Patriot Hills, where a blue ice runway exists and supplies and personnel can be flown directly from Punta Arenas, Chile. These locations make the drilling easier to manage, strong environmental protocols more easily to apply, and the access for international inspection easier. These subglacial aquatic environments are thus good candidates for investigations based on logistical criteria.

Unfortunately, the basic hydrology of Lake Concordia and South Pole Lake is completely unknown, so the potential environmental impact of sampling these lakes on other subglacial aquatic environments in their respective drainage basins is also unknown. However, the basic hydrology of Lake Vostok and Lake Ellsworth is understood, and they appear to be good candidates for exploration.

It is important that lessons learned in exploring a particular lake be transmitted quickly and effectively to the broader scientific community and that all progress in this field be adequately documented for each site. In this way, technology can advance as quickly as possible. Also, hydrologic connections between the lakes need to be carefully monitored and updated because these connections will have an impact on potential exploration strategies.

During exploration, it will be important to establish systems that to allow for clean monitoring of the lake, to both assess the impact of the sampling and to provide for easier and cleaner access in the future. These systems may include in situ devices for long-term monitoring of the lake, technologies such as probes that transmit data back to the ice surface, and devices to provide clean access to the lake water for future sampling. Setting aside some lakes to test sampling techniques is a potential strategy to aid in the development of practical and minimally contaminating sampling equipment. Maintaining detailed information about activities associated with these environments is a requirement of the Antarctic Treaty protocol. A record of any material components used in the exploration of subglacial lakes that may influence future research and information regarding drilling components, such as the microbial content of drilling fluids will be important to the development of the exploration protocols and future investigations.

#### **Recommendation 10**

*Allowances should be made for certain objects and materials to be placed into experimental subglacial aquatic environments for scientific purposes—for example, for monitoring or tracing dynamics. These additions should follow the microbiological constraints in Recommendation 7 and include discussion of an environmental risk versus scientific benefit analysis in the Comprehensive Environmental Evaluation.*

#### **Recommendation 11**

*As the initial step to define an overall exploration strategy, the United States, together with other interested parties, should begin immediately to obtain remote sensing data to characterize a wide range of subglacial aquatic environments. As a second step, preliminary data and samples should be obtained from subglacial aquatic environments immediately to guide future environmental stewardship, scientific investigations, and technological developments.*

#### **Recommendation 12**

*Remote sensing of the potential aquatic environments beneath the Antarctic ice sheet is underway but is far from complete. The following actions should proceed in order to make a decision about which subglacial aquatic environments should be studied in the future:*

- *Continent-scale radio-echo sounding data should be assembled and subglacial aquatic environments identified;*
- *All regions where the basal melt-rate is likely high should be identified;*
- *Detailed radio-echo sounding of known lakes should be done;*

- *A hydrologic map of the subglacial drainage system for each catchment should be constructed;*
- *Potential target environments should be identified based on the subglacial drainage system.*

*Once potential research sites are identified, the likelihood of attaining scientific goals should be evaluated based on the representativeness for other lakes and settings, for accessibility, and for the constraints of logistics and cost. The committee recognizes that plans are underway to sample Lake Vostok, and in the longer term Lake Ellsworth and Lake Concordia. The data collected from these endeavors should be used to assess whether the levels of cleanliness suggested in Recommendation 7 are appropriate.*

### RESEARCH NEEDS

At present, no clean drilling, sampling or monitoring technologies have been developed for exploration of subglacial aquatic environments. Development of new technologies needs to focus on methods to reduce contamination and to assess the contaminant load after sterilization. A standard method to ensure cleanliness that can be verified in the field is a critical need.

To achieve these goals, research is needed in two main areas: (1) microbial background levels and instrument cleanliness, and (2) clean drilling fluids. The baseline levels of microbes in the glacial ice and subglacial waters and the basic chemistry of all phases of these environments are not well established. In the case of background microbial levels, it may be possible to obtain ice samples from the ICECUBE project to investigate microbial background loadings in the glacial ice and the base-level contamination of hot-water drilling. Research from accretion ice cores is also needed to establish partition coefficients, which will help establish contamination limits. Using various technologies, it is necessary to assess the impacts of access and sampling and provide data to develop improved technologies for easier and cleaner access in the future.

Although hot-water drilling presents the greatest possibility for clean drill fluids, the time that a hole can be kept open and the depth to which hot-water holes can be drilled are limited. Drill fluids that do not freeze (e.g., jet fuel) have significant levels of biological contamination, but these fluids can provide indefinite access to a lake with periodic maintenance of the hole. New types of drilling fluids are needed that would not be substrates for microbial growth. Methods to clean the fluids prior to field deployment, as well as methods to clean them in the field, are also required. Development of filtering methods for borehole and drilling fluids may prove effective, along with in-line ultraviolet (UV) sterilization techniques or the addition of bactericides to the drilling fluids. It will be important to assess and document the biological and chemical contaminant content of all fluids used.

Cleaner monitoring and sampling technologies will have to be developed. Some priority areas include the following examples. Inert tracers in the drill fluid or fluid used to enter the lake need to be developed to track the level and distribution of contaminants within the lake. Development of miniaturized monitoring equipment will make it easier both to insert observatories into the water bodies and to retrieve them. A remote observatory designed for subglacial aquatic environments that could be inserted through a small borehole could provide long-term monitoring of the water or

sediments. To achieve this type of observatory, there is a need for probes that transmit data back to the ice surface and devices to provide clean access to the lake water for future sampling. Technological advances are needed for clean sediment sampling that will not disturb the water column.

### Recommendation 13

*Research and development should be conducted on methods to reduce microbial contamination throughout the drilling, sampling, and monitoring processes, on methods to determine the background levels of microbes in glacial ice and lake water, and on development of miniaturized sampling and monitoring instruments to fit through the drilling hole. The following methods and technologies need to be improved or developed:*

- *A standard method to ensure cleanliness for drilling, sampling, and monitoring equipment that can be verified in the field;*
- *New ways of drilling through the ice sheet that include drilling fluids that would not be a substrate for microbial growth;*
- *Inert tracers in the drill fluids or fluids used to enter the lake to track the level and distribution of contaminants within the lake;*
- *Methods to determine baseline levels of microbes in the glacial ice and subglacial waters;*
- *Instrumentation scaled to fit through a bore hole, to measure chemistry and biology of these environments and transmit data back to the ice surface;*
- *Methods to provide clean access to the lake water for extended periods.*

*The committee recognizes that plans are underway to sample Lake Vostok, and in the longer term, Lake Ellsworth and Lake Concordia. The data collected from these endeavors should be used to better assess the requirements of future methodologies and technologies.*

## GUIDELINES FOR STEWARDSHIP, MANAGEMENT, AND PROJECT REVIEW

This report provides an initial framework for the environmental stewardship for exploration of subglacial aquatic environments. Recommendations are based on current understanding of these environments, which is limited and incomplete. As the science and exploration of subglacial environments grow beyond their infancy, the initial methodologies and protocols recommended in this report will need further development and regular revision on both a national and an international scale.

All aspects of management, stewardship, and project review and approval will continue to involve absolute requirements mandated by the Antarctic Treaty, government standards specific to particular parties, and scientific standards such as those recommended by SCAR. The recommendations of the committee are thus intended for integration into this important multifaceted framework.

An overview of the committee's recommendations and a suggested sequence and framework to address the key areas of importance for subglacial lakes—stewardship, management, and project review is shown in Figure 6.1, definitions are in Box 6.1. This framework is deliberately consistent with the guidelines of the Antarctic Treaty,



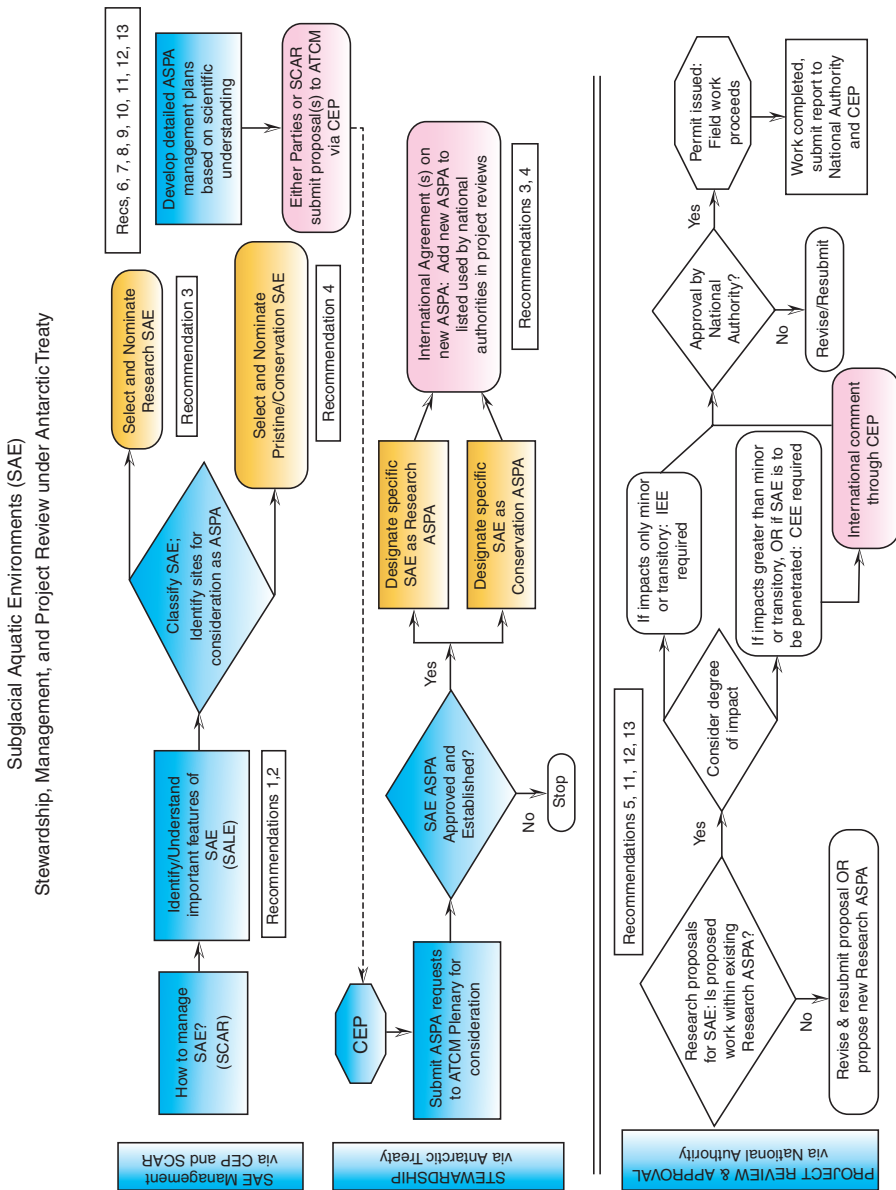

FIGURE 6.1 Sequence and framework to address stewardship, management, and project review for subglacial aquatic environments. SOURCE: Dr. Margaret S. Race, Committee Member.

---

### BOX 6.1 Explanation of Terms in Figure 6.1

**Antarctic Specially Protected Area (ASP):** A specially designated area that provides protection for outstanding environmental, scientific, historic, or aesthetic values or for ongoing or proposed scientific research. Each area has a management plan that provides the details of what actions can and cannot be undertaken in the area. All entry to ASPAs is by permit only issued by individual parties on application.

**Antarctic Treaty:** Provides governance via the annual Antarctic Treaty Consultative Meetings (ATCMs) at which the ATCM Plenary makes the final decision on recommendations from its constituents' working groups and committees.

**Antarctic Treaty Secretariat:** Supports the treaty between sessions, helps organize and run the annual ATCM meetings, and acts as the repository for official papers and information (which at present does *not* include scientific information).

**Committee for Environmental Protection (CEP):** Advises the ATCM Plenary on all aspects of environmental management covered by the Protocol on Environmental Protection.

**Comprehensive Environmental Evaluation (CEE):** A project review document undertaken when the predicted environmental impact is greater than minor and/or transitory. A CEE requires considerable detailed information; the draft must be made publicly available and circulated to parties, allowing at least 90 days for comment, and submitted to the CEP at least 120 days before the next Consultative Meeting. A final CEE must address all the comments received and must be circulated to parties and made publicly available at least 60 days before the start of the proposed activity.

**Initial Environmental Evaluation (IEE):** Environmental review document undertaken when the predicted environmental impact of a proposed project is minor and/or transitory. It is normally reported to the treaty parties but is not circulated for comment.

**National Authorities:** The governance structure of each nation (Consultative Party) for implementing the Antarctic Treaty. For the United States:

State Party = U.S. Department of State (political aspects of the treaty);

Science Group = NRC Polar Research Board, U.S. representative to SCAR;

Management / Logistics = NSF Office of Polar Programs (the U.S. representative to COMNAP, the Council of Managers of National Antarctic Programmes)

**Scientific Committee on Antarctic Research (SCAR):** an interdisciplinary committee of the International Council for Science (ICSU), that initiates, develops, and coordinates high-quality international scientific research in the Antarctic region and on the role of the Antarctic region in the Earth system. SCAR also provides objective and independent scientific advice to the Antarctic Treaty Consultative Meetings and other organizations on issues of science and conservation affecting the management of Antarctica and the Southern Ocean. SCAR has national representation from those countries with an active scientific interest in Antarctica.

**Subglacial Antarctic Lake Program (SALE):** Created by SCAR as a major international research program that provides the framework within which the science objectives are agreed upon by scientists interested in subglacial lakes; SALE also coordinates the pooling of data and specimens, and organizes workshops

as well as national and international programs or authorities that are involved in the treaty process.<sup>6</sup> It also has the necessary flexibility to update information and evolve over time as new findings accumulate about drilling, biological and geological information, and exploration methods.

The committee's recommendations can be tracked in the diagram (Figure 6.1). Recommendations 1 and 2 state the committee's strong belief that carefully managed scientific research on subglacial lakes should begin while preserving the environment for future potential discoveries through a suitably conservative approach. Working through SCAR, it will be important to develop criteria and research specifications that may be incorporated into management plans for subglacial aquatic environments (Recommendations 3, 4, 6, 7, 8, 9, 10, and 12). An initial research protocol is outlined in Recommendation 12 and is intended for both international and national levels.

Exploration will continue to be subject to formal peer review through Antarctic Treaty protocols (e.g., CEE), as soon as adequate survey data have been gathered to provide a sound basis for description and include comment by SCAR where appropriate. Stewardship for the future is best addressed by establishing a dynamic multinational approach and specific scientific archive that preserves and quantifies pertinent information associated with current scientific research, nationally and internationally (Recommendations 5, 11, 12, 13). Maintaining detailed information about activities associated with these environments is a requirement of the Antarctic Treaty protocol and the committee hopes that information regarding drilling components, such as the microbial content of drilling fluids and any material components that may influence future research will be an important part of the stewardship for the exploration of subglacial aquatic environments.

The exploration of subglacial aquatic environments is in its initial stages, with fundamental questions remaining to be answered about these unique environments. Much debate and speculation have occurred based on the limited data available; no definitive answers will be forthcoming until these environments are sampled directly. The existence of these environments on the Antarctic continent makes them a part of the common heritage of all humankind. Accordingly, the management of subglacial aquatic environments requires responsible environmental stewardship while allowing field research in accordance with the Antarctic Treaty. Although this study is being produced by a U.S. scientific advisory body, and the U.S. National Science Foundation (NSF) requested this study to guide scientific programs originating in the United States, the committee hopes that its multinational makeup will be recognized and that the recommendations in this report will serve as a basis for broad international discussion about environmental stewardship for the exploration of subglacial aquatic environments.

---

<sup>6</sup>(1) Management of the subglacial aquatic environments via the Committee for Environmental Protection and the Scientific Committee on Antarctic Research; (2) continuing stewardship of these environments through the processes of the Antarctic Treaty, and the formal request that specific subglacial aquatic environments be designated as Antarctic Specially Protected Areas, either for long-term conservation or for agreed scientific research; and (3) the scientific project review and approval process involving national authorities and international oversight through the CEP.

## References

- Abyzov, S. S., 1993: Microorganisms in the Antarctic ice. In Friedmann, I. (ed.), *Antarctic Microbiology*. New York: Wiley-Liss, 265-295.
- Abyzov, S. S., Mitskevich, I. N., and Poglazova, M. N., 1998: Microflora of the deep glacier horizons of Central Antarctica. *Microbiology*, 67: 547-555.
- Abyzov, S. S., Mitskevich, I. N., Poglazova, M. N., Barkov, N. I., Lipenkov, V. Y., Bobin, N. E., Koudryashov, B. B., Pashkevich, V. M., and Ivanov, M. V., 2001: Microflora in the basal strata at Antarctic ice core above the Vostok Lake. *Advances in Space Research*, 28: 701-706.
- Abyzov, S. S., Poglazova, M. N., Mitskevich, I. N., and Ivanov, M. V., 2005: Common features of microorganisms in ancient layers of the Antarctic ice sheet. In Castello, J. D. and Rogers, S. O. (eds.), *Life in Ancient Ice*. Princeton and Oxford: Princeton University Press, 240-250.
- Aldsworth, T. G., Sharman, R. L., and Dodd, C. E. R., 1999: Bacterial suicide through stress. *Cellular and Molecular Life Sciences (CMLS)*, 56: 378-383.
- Alekhina, I. A., Marie, D., Petit, J. R., Lukin, V. V., Zubkov, V. M., and Bulat, S. A., 2007: Molecular analysis of bacterial diversity in kerosene-based drilling fluid from the deep ice borehole at Vostok, East Antarctica. *FEMS Microbiology Ecology*, 59: 289-299.
- Alley, R. B., Lawson, D. E., Evenson, E. B., Strasser, J. C., and Larson, G. J., 1998: Glaciohydraulic supercooling: A freeze-on mechanism to create stratified, debris-rich basal ice: II. Theory. *Journal of Glaciology*, 44: 563-569.
- Alley, R. B., Dupont, T. K., Parizek, B. R., Anandakrishnan, S., Lawson, D. E., Larson, G. J., and Evenson, E. B., 2006: Outburst flooding and the initiation of ice-stream surges in response to climatic cooling: A hypothesis. *Geomorphology*, 75: 76-89.
- Andersen, K. K., Azuma, N., Barnola, J.-M., Bigler, M., Biscaye, P., Caillon, N., Chappellaz, J., Clausen, H. B., Dahl-Jensen, D., Fischer, H., Flückiger, J., Fritzsche, D., Fujii, Y., Goto-Azuma, K., Grønbold, K., Gundestrup, N. S., Hansson, M., Huber, C., Hvidberg, C. S., Johnsen, S. J., Jonsell, U., Jouzel, J., Kipfstuhl, S., Landais, A., Leuenberger, M., Lorrain, R., Masson-Delmotte, V., Miller, H., Motoyama, H., Narita, H., Popp, T., Rasmussen, S. O., Raynaud, D., Rothlisberger, R., Ruth, U., Samyn, D., Schwander, J., Shoji, H., Siggard-Andersen, M.-L., Steffensen, J. P., Stocker, T., Sveinbjörnsdóttir, A. E., Svensson, A., Takata, M., Tison, J.-L., Thorsteinsson, T., Watanabe, O., Wilhelms, F. J., and C. W. W., 2004: High-resolution record of Northern Hemisphere climate extending into the last interglacial period. *Nature*, 431: 147-151.
- Anderson, J. B., 1999: *Antarctic Marine Geology*. New York: Cambridge University Press, 289 pp.
- Anderson, K. K., 2004: High-resolution record of Northern Hemisphere climate extending into the last interglacial period. *Nature*, 431: 47-51.

- Arnold, B. R., Christner, B. C., and Priscu, J. C., 2005: Isolation and characterization of microorganisms in glacial and accreted ice from the Vostok ice core: Is there life in Lake Vostok? *American Society of Limnology and Oceanography, Aquatic Sciences Meeting*: poster presentation 783.
- Bartlett, D. H., 2002: Pressure effects on in vivo microbial processes. *Biochimica et Biophysica Acta—Protein Structure and Molecular Enzymology*, 1595: 367-381.
- Basile, I., Petit, J. R., Touron, S., Grousset, F. E., and Barkov, N., 2001: Volcanic layers in Antarctic (Vostok) ice cores: Source identification and atmospheric implications. *Journal of Geophysical Research*, 106: 31,915-931, 932.
- Baumgartner, M., Stetter, K. O., and Foissner, W., 2002: Morphological, small subunit rRNA, and physiological characterization of *Trimyema minutum* (Kahl, 1931), an anaerobic ciliate from submarine hydrothermal vents growing from 28°C to 52°C. *Journal of Eukaryotic Microbiology*, 49: 227-238.
- Bay, R., Bramall, N. E., and Price, P. B., 2005: Search for microbes and biogenic compounds in polar ice using fluorescence. In Castello, J. D. and Rogers, S. O. (eds.), *Life in Ancient Ice*. Princeton and Oxford: Princeton University Press, 268-276.
- Bechtold, U., Murphy, D. J., and Mullineaux, P. M., 2004: Arabidopsis peptide methionine sulfoxide reductase2 prevents cellular oxidative damage in long nights. *The Plant Cell*, 16: 908-919.
- Behrendt, J. C., Finn, C. A., Blankenship, D., and Bell, R. E., 1998: Aeromagnetic evidence for a volcanic caldera (?) complex beneath the divide of the West Antarctic Ice Sheet. *Geophysical Research Letters*, 25: 4385-4388.
- Bell, R., Studinger, M., Tikku, A., and Castello, J. D., 2005: Comparative biological analyses of accretion ice from subglacial Lake Vostok. In Castello, J. D. and Rogers, S. O. (eds.), *Life in Ancient Ice*. Princeton and Oxford: Princeton University Press, 251-267.
- Bell, R. E., Studinger, M., Tikku, A. A., Clarke, G. K. C., Gutner, M. M., and Meertens, C., 2002: Origin and fate of Lake Vostok water frozen to the base of the East Antarctic ice sheet. *Nature*, 416: 307-310.
- Bell, R. E., Studinger, M., Fahnestock, M. A., and Shuman, C. A., 2006: Tectonically controlled subglacial lakes on the flanks of the Gamburtsev Subglacial Mountains, East Antarctica. *Geophysical Research Letters*, 33: doi:10.1029/2005GL025207.
- Belzile, C., Gibson, J. A. E., and Vincent, W. F., 2002: Colored dissolved organic matter and dissolved organic carbon exclusion from lake ice: Implications for irradiance transmission and carbon cycling. *Limnology and Oceanography*, 47: 1283-1293.
- Bennet, P. M., 2004: Genome Plasticity: Insertion sequence elements, transposons and integrons and DNA rearrangements. In Woodfer, N. and Johnson, A. P. (eds.), *Genomics, Proteomics, and Clinical Bacteriology: Methods in Molecular Biology Volume 266*. Totowa, NJ: Humana Press Inc., 71-114.
- Björnsson, H., 2002: Subglacial lakes and jökulhlaups in Iceland. *Global and Planetary Change*, 35: 255-271.
- Blankenship, D., Young, D. A., and Carter, S. P., 2006: The distribution of Antarctic subglacial lakes environments with implication for their origin and evolution. *SALE-Advanced Science and Technology Planning Workshop*, 24-26 April, Grenoble, France.
- Bochner, B. R., 1989: Sleuthing out bacterial identities. *Nature*, 339: 157-158.
- Bonilla, S., Villeneuve, V., and Vincent, W. F., 2005: Benthic and planktonic algal communities in a high arctic lake: Pigment structure and contrasting responses to nutrient enrichment. *Journal of Phycology*, 41: 1120-1130.
- Boulton, G. S. and Caban, P., 1995: Groundwater flow beneath ice sheets: Part II—Its impact on glacier tectonic structures and moraine formation. *Quaternary Science Reviews*, 14: 563-587.
- Boulton, G. S., Caban, P. E., and Van Gijssel, K., 1995: Groundwater flow beneath ice sheets: Part I—Large scale patterns. *Quaternary Science Reviews*, 14: 545-562.
- Brock, T. D., 1995: The road to yellowstone—and beyond. *Annual Review of Microbiology*, 49: 1-28.
- Brock, T. D., 1997: The value of basic research: Discovery of *thermus aquaticus* and other extreme thermophiles. *Genetics*, 146: 1207-1210.
- Bulat, S., Alekhina, I. A., Lipenkov, V., Lukin, V., Marie, D., and Petit, J.-R., 2006: Deliberations on microbial life in the subglacial Lake Vostok, East Antarctica. *International Conference of Polar and Alpine Microbiology*: Abstract L61.
- Bulat, S. A., Alekhina, I. A., Blot, M., Petit, J.-R., de Angelis, M., Wagenbach, D., Lipenkov, V. Y., Vasilyeva, L. P., Wloch, D. M., Raynaud, D., and Lukin, V. V., 2004: DNA signature of thermophilic bacteria from the aged accretion ice of Lake Vostok, Antarctica: implications for searching for life in extreme icy environments. *International Journal of Astrobiology*, 3: 1-12.

- Carter, S. P., Blankenship, D. D., Peters, M. E., Young, D. A., and Morse, D. L., 2007: Radar-based subglacial lake classification in Antarctica. *Geochemistry, Geophysics, Geosystems*, 8: Q03016, doi:03010.01029/02006GC001408.
- Castello, J. D. and Rogers, S. O., 2005: A synopsis of the past, an evaluation of the current and a glance toward the future. In Castello, J. D. and Rogers, S. O. (eds.), *Life in Ancient Ice*. Princeton and Oxford: Princeton University Press, 289-300.
- Castello, J. D., Rogers, S. O., Smith, J. E., Starmer, W. T., and Zhao, Y., 2005: Plant and bacterial viruses in the Greenland Ice Sheet. In Castello, J. D. and Rogers, S. O. (eds.), *Life in Ancient Ice*. Princeton and Oxford: Princeton University Press, 196-207.
- Chen, C. T. and Millero, F. J., 1986: Precise thermodynamic properties for natural waters covering only the limnological range. *Limnology and Oceanography*, 31: 657-662.
- Chou, I.-M., Sharma, A., Burruss, R. C., Shu, J., Mao, H., Hemley, R. J., Goncharov, A. F., Stern, L. A., and Kirby, S. H., 2000: Transformations in methane hydrates. *Proceedings of the National Academy of Sciences*, 97: 13484-13487.
- Christner, B. C., Mosley-Thompson, E., Thompson, L. G., and Reeve, J. N., 2001: Isolation of bacteria and 16S rDNAs from Lake Vostok accretion ice. *Environmental Microbiology*, 3: 570-577.
- Christner, B. C., 2002: Incorporation of DNA and protein precursors into macromolecules by bacteria at -15°C. *Applied and Environmental Microbiology*, 68: 6435-6438.
- Christner, B. C., Mosley-Thompson, E., Thompson, L. G., and Reeve, J. N., 2003: Bacterial recovery from ancient glacial ice. *Environmental Microbiology*, 5: 433-436.
- Christner, B. C., Mikucki, J. A., Foreman, C. M., Denson, J., and Priscu, J. C., 2005a: Glacial ice cores: A model system for developing extraterrestrial decontamination protocols. *Icarus*, 174: 572-584.
- Christner, B. C., Mosley-Thompson, E., Thompson, L. G., and Reeve, J. N., 2005b: Classification of bacteria from polar and nonpolar glacial ice. In Castello, J. D. and Rogers, S. O. (eds.), *Life in Ancient Ice*. Princeton and Oxford: Princeton University Press, 227-239.
- Christner, B. C., Royston-Bishop, G., Foreman, C. M., Arnold, B. R., Tranter, M., Welch, K. A., Lyons, W. B., Tsapin, A. I., Studinger, M., and Priscu, J. C., 2006: Limnological conditions in subglacial Lake Vostok, Antarctica. *Limnology and Oceanography*, 51: 2485-2501.
- Church, G. M., 2006: Genomes for all. *Scientific American*, January: 47-54.
- Church, J. A., Gregory, J. M., Huybrechts, P., Kuhn, M., Lambeck, K., Nhuan, M. T., Qin, D., and Woodworth, P. L., 2001: Changes in sea level. In Houghton, J. T., Ding, Y., Griggs, D. J., Noguer, M., van der Linden, P. J., Dai, X., Maskell, K., and Johnson, C. A. (eds.), *Climate change 2001: The scientific basis. Contributions of Working Group I to the Third Assessment Report of the Intergovernmental Panel on Climate Change*. Cambridge, U.K. and New York, USA.: Cambridge University Press., 881.
- Circone, S., Stern, L. A., Kirby, S. H., Durham, W. B., Chakoumakos, B. C., Rawn, C. J., Rodinone, A. J., and Ishii, Y., 2003: CO<sub>2</sub> hydrate: synthesis, composition, structure, dissociation behavior, and a comparison to structure I CH<sub>4</sub> hydrates. *Journal of Physical Chemistry B*, 107: 5529-5539.
- Circone, S., Stern, L. A., and Kirby, S. H., 2004: The effect of elevated methane pressure on methane hydrate dissociation. *American Mineralogists*, 89: 1192-1201.
- Clarke, G. K. C., Leverington, D. W., Teller, J. T., Dyke, A. S., and Marshall, S. J., 2005: Fresh arguments against the Shaw megaflood hypothesis. A reply to comments by David Sharpe on "Paleohydraulics of the last outburst flood from glacial Lake Agassiz and 8200 BP cold event." *Quaternary Science Reviews*, 24: 1533-1541.
- Clarke, G. K. C., 2006: Ice-sheet plumbing in Antarctica. *Nature*, 440: 1000-1001.
- Cohan, F. M., 2002: What are bacterial species? *Annual Review of Microbiology*, 56: 457-487.
- COSPAR, 2002: *Planetary Protection Policy, October 2000 as amended, March 2005*. <http://www.cosparhq.org/scistr/PPPPolicy.htm>.
- COSPAR, 2003: *Report on the 34th COSPAR Assembly, COSPAR Information Bulletin, No. 156, April, pp. 2467-71*. Elsevier Science Ltd. Oxford, United Kingdom, Oxford.
- D'Hondt, S., Jørgensen, B. B., Miller, D. J., Batzke, A., Blake, R., Cragg, B. A., Cypionka, H., Dickens, G. R., Ferdelman, T., Hinrichs, K. U., Holm, N. G., Mitterer, R., Spivack, A., Wang, G., Bekins, B., Engelen, B., Ford, K., Gettemy, G., Rutherford, S. D., Sass, H., Skilbeck, C. G., Aiello, I. W., Guerin, G., House, C. H., Inagaki, F., Meister, P., Naehr, T., Niitsuma, S., Parkes, R. J., Schippers, A., Smith, D. C., Teske, A., Wiegel, J., Padilla, C. N., and Acosta, J. L. S., 2004: Distributions of microbial activities in deep subseafloor sediments. *Science*, 306: 2216-2221.
- Dalziel, I. W. D., 2006: On the extent of the active West Antarctic rift system. *Terra Antarctica Reports*: 193-202.

- de Angelis, M., Petit, J.-R., Savarino, J., Souchez, R., and Thiemens, M. H., 2004: Contributions of an ancient evaporitic-type reservoir to subglacial Lake Vostok chemistry. *Earth and Planetary Science Letters*, 222: 751-765.
- de Quetteville Robin, G. and Drewry, D. J., 2003: Children of the "Golden Age." *Polar Record*, 39: 61-78.
- De Vincenzi, D. L., 1992: Planetary protection issues and the future exploration of Mars. *Advances in Space Research*, 12: 121-128.
- Delmonte, B., Basile-Doelsch, I., Petit, J. R., Maggi, V., Revel-Rolland, M., Michard, A., Jagoutz, E., and Grousset, F., 2004: Comparing the Epica and Vostok dust records during the last 220,000 years: Stratigraphical correlation and provenance in glacial periods. *Earth-Science Reviews*, 66: 63-87.
- DeVincenzi, D. L. and Stabekis, P. D., 1984: Revised planetary protection policy for solar system exploration. *Advances in Space Research*, 4: 291-295.
- Ditmar, T., 2004: Evidence for terrigenous dissolved organic nitrogen in the Arctic deep sea. *Limnology and Oceanography*, 49: 148-156.
- Dodd, C. E. R., Sharman, R. L., Bloomfield, S. F., Booth, I. R., and Stewart, G. S. A. B., 1997: Inimical processes: Bacterial self-destruction and sub-lethal injury. *Trends in Food Science and Technology*, 8: 238-241.
- Domenico, P. A. and Schwartz, F. W., 1990: *Physical and Chemical Hydrogeology*. New York: John Wiley & Sons, Ltd., 824 pp.
- Domenico, P. A. and Schwartz, F. W., 1998: *Physical and chemical hydrogeology. Second edition*. New York: John Wiley & Sons, Ltd.
- Doolittle, W. and Papke, R. T., 2006: Genomics and the bacterial species problem. *Genome Biology*, 7.
- Doran, P. T., Fritsen, C. H., McKay, C. P., Priscu, J. C., and Adams, E. E., 2003: Formation and character of an ancient 19-m ice cover and underlying trapped brine in an "ice-sealed" east Antarctic lake. *Proceedings of the National Academy of Sciences of the United States of America*, 100: 26-31.
- Doran, P. T., Priscu, J. C., Lyons, W. B., Powell, R. D., Andersen, D. T., and Poreda, R. J., 2004: Paleolimnology of extreme cold terrestrial and extraterrestrial environments. In Pienitz, R., Douglas, M. S. V., and Smol, J. P. (eds.), *Long-Term Environmental Change in Arctic and Antarctic Lakes*. Dordrecht, The Netherlands: Kluwer Academic Publishers, 475-507.
- Dowdeswell, J. A. and Siegert, M. J., 1999: The dimensions and topographic setting of Antarctic subglacial lakes and implications for large-scale water storage beneath continental ice sheets. *Geological Society of America Bulletin*, 111: 254-263.
- Dowdeswell, J. A. and Siegert, M. J., 2003: The physiography of modern Antarctic subglacial lakes. *Global and Planetary Change*, 35: 221-236.
- Drees, K. P., Neilson, J. W., Betancourt, J. L., Quade, J., Henderson, D. A., Pryor, B. M., and Maier, R. M., 2006: Bacterial community structure in the hyperarid core of the Atacama Desert, Chile. *Applied and Environmental Microbiology*, 72: 7902-7908.
- Drewry, D. J., 1983: *Antarctic Glaciological and Geophysical Folio*. Cambridge, U.K.: Scott Polar Research Institute.
- Duxbury, N. S., Zotikov, I. A., Neelson, K. H., Romanovsky, V. E., and Carsey, F. D., 2001: A numerical model for an alternative origin of Lake Vostok and its exobiological implications for Mars. *Journal of Geophysical Research*, 106: 1453-1462.
- Duxbury, N. S., Abyzov, S. S., Romanovsky, V. E., and Yoshikawa, K., 2004: A combination of radar and thermal approaches to search for methane clathrate in the Martian subsurface. *Planetary and Space Science*, 52: 109-115.
- Engelhardt, H., Kamb, B., and Bolsey, R., 2000: A hot-water ice-coring drill. *Journal of Glaciology*, 46: 341-345.
- EPICA, 2004: Eight glacial cycles from an Antarctic ice core. *Nature*, 429: 623-628.
- Erlingsson, U., 1994a: The "captured ice shelf" hypothesis and its applicability to the Weichselian glaciation. *Geografiska Annaler*, 76A: 2-12.
- Erlingsson, U., 1994b: A computer model along a flow-line of an ice dome—"captured ice shelf." *Geografiska Annaler*, 76A: 13-24.
- Erlingsson, U., 2006: Lake Vostok behaves like a "captured lake" and may be near to creating an Antarctic jökulhlaup. *Geografiska Annaler*, 88A: 1-7.
- Evatt, G. W., Fowler, A. C., Clark, C. D., and Hulton, N. R. J., 2006: Subglacial floods beneath ice sheets. *Philosophical Transactions of the Royal Society A*, 364: 1769-1794.
- Fenchel, T., 2003: Biogeography for bacteria. *Science*, 301: 925-926.

- Fitzsimons, I. C. W., 2003: Proterozoic basement provinces of southern and southwestern Australia, and their correlation with Antarctica. In Yoshida, M., Windley, B. F., and Dasgupta, S. (eds.), *Proterozoic East Gondwana: Supercontinent Assembly and Breakup*. London: Geological Society, Special Publication 206, 93-130.
- Fraser, C., Hanage, W. P., and Spratt, B. G., 2007: Recombination and the nature of bacterial speciation. *Science*, 315: 476-480.
- Fricke, H. A., Scambos, T., Bindschadler, R., and Padman, L., 2007: An active subglacial water system in West Antarctica mapped from space. *Science*, 315: 1544-1548.
- Futterer, O., Angelov, A., Liesegang, H., Gottschalk, G., Schleper, C., Schepers, B., Dock, C., Antranikian, G., and Liebl, W., 2004: Genome sequence of *Picrophilus torridus* and its implications for life around pH 0. *Proceedings of the National Academy of Sciences of the United States of America*, 101: 9091-9096.
- Gibson, J. A. E., 1999: The meromictic lakes and stratified marine basins of the Vestfold Hills, East Antarctica. *Antarctic Science*, 11: 175-192.
- Gibson, J. A. E., Vincent, W. F., Nieke, B., and Pienitz, R., 2000: Control of biological exposure to UV radiation in the Arctic Ocean: Comparison of the roles of ozone and riverine dissolved organic matter. *Arctic*, 53: 372-382.
- Gillooly, J. F., Allen, A. P., West, G. B., and Brown, J. H., 2005: The rate of DNA evolution: Effects of body size and temperature on the molecular clock. *Proceedings of the National Academy of Sciences of the United States of America*, 102: 140-145.
- Giovinetto, M. B., Waters, N. M., and Bentley, C. R., 1990: Dependence of Antarctic surface mass balance on temperature, elevation, and distance to open ocean. *Journal of Geophysical Research*, 95: 3517-3531.
- Gorman, M. R. and Siegert, M. J., 1999: Penetration of Antarctic subglacial lakes by VHF electromagnetic pulses: Information on the depth and electrical conductivity of basal waterbodies. *Journal of Geophysical Research-Solid Earth*, 104: 29311-29320.
- Gow, A. J., Ueda, H. T., and Garfield, D. E., 1968: Antarctic ice sheet: Preliminary results of the first core hole to bedrock. *Science*, 161: 1011-1013.
- Graur, D. and Li, W.-H., 2000: *Fundamentals of molecular evolution, 2nd Edition*. Sunderland, MA: Sinauer Associates Inc., 443 pp.
- Gray, L., Joughin, I., Tulaczyk, S., Spikes, V. B., Bindschadler, R., and Jezek, K., 2005: Evidence for subglacial water transport in the West Antarctic Ice Sheet through three-dimensional satellite radar interferometry. *Geophysical Research Letters*, 32.
- Griffin, D. W., Kellogg, C. A., Garrison, V. H., and Shinn, E. A., 2002: The global transport of dust. *American Scientist*, 90: 228-235.
- Handelsman, J., 2004: Metagenomics: Application of genomics to uncultured microorganisms. *Microbiology and Molecular Biology Reviews*, 68: 669-685.
- Hayashi, N. R., Ishida, T., Yokota, A., Kodama, T., and Igarashi, Y., 1999: *Hydrogenophilus thermoluteolus* gen. nov., sp. nov., a thermophilic, facultatively chemolithoautotrophic, hydrogen-oxidizing bacterium. *International Journal of Systematic Bacteriology* 49: 783-786.
- Hobbie, J. E., 1973: Arctic limnology. In Britton, M. E. (ed.), *Alaskan Arctic Tundra*. Washington, DC: Arctic Institute of North America, Technical Paper No. 25, 127-168.
- Hoehler, T. M., 2004: Biological energy requirements as quantitative boundary conditions for life in the subsurface. *Geobiology*, 2: 205-215.
- Horner-Devine, M. C., Leibold, M. A., Smith, V. H., and Bohannon, B. J. M., 2003: Bacterial diversity patterns along a gradient of primary productivity. *Ecology Letters*, 6: 613-622.
- Hugenholtz, P., Goebel, B. M., and Pace, N. R., 1998: Impact of culture independent studies on the emerging phylogenetic view of bacterial diversity. *Journal of Bacteriology*, 180: 4765-4774.
- Hurst, C. J., Knudsen, G. R., McInerney, M. J., Stetzenbach, L. D., and Walter, M. V., 1997: *Manual of Environmental Microbiology*. Washington, DC: American Society for Microbiology, 894 pp.
- Huybrechts, P., 1990: A 3-D model for the Antarctic ice sheet: a sensitivity study on the glacial-interglacial contrast. *Climate Dynamics*, 5: 79-92.
- Ikeda, T., Fukazawa, H., Mae, S., Pepin, L., Duval, P., Champagnon, B., Lipenkov, V. Y., and Hondoh, T., 1999: Extreme fractionation of gases caused by formation of clathrate hydrates in Vostok Antarctic ice. *Geophysical Research Letters*, 26: 91-94.
- Imlay, J. A., 2002: What biological purpose is served by superoxide reductase? *Journal of Biological Inorganic Chemistry*, 7: 659-663.



- Inman, M., 2005: The Plan to Unlock Lake Vostok. *Science*, 310: 611-612.
- Irwin, R. J., Mouwerik, M. V., Stevens, S., Seese, M. D., and Basham, W., 1997: *Environmental Contaminants Encyclopedia-PAHs Entry*. National Parks Service, Water Resources Division.
- Ivancic-Bace, I., Vlastic, I., Cogelja-Cajo, G., Brcic-Kostic, K., and Salaj-Smic, E., 2006: Roles of PriA protein and double-strand DNA break repair functions in UV-induced restriction alleviation in *Escherichia coli*. *Genetics*, 174: 2137-2149.
- Jackson, B. E. and McNerney, M. J., 2002: Anaerobic microbial metabolism can proceed close to thermodynamic limits. *Nature*, 415: 454-456.
- Jean-Baptiste, P., Petit, J. R., Lipenkov, V. Y., Raynaud, D., and Barkov, N. I., 2001: Constraints on hydrothermal processes and water exchange in Lake Vostok from helium isotopes. *Nature*, 411: 460-462.
- Jenkins, A. and Doake, C. S. M., 1991: Ice-ocean interaction on Ronne Ice Shelf, Antarctica. *Journal of Geophysical Research*, 96: 791-813.
- Jouzel, J., Petit, J. R., Souchez, R., Barkov, N. I., Lipenkov, V. Y., Raynaud, D., Stievenard, M., Vassiliev, N. I., Verbeke, V., and Vimeux, F., 1999: More than 200 meters of lake ice above subglacial Lake Vostok, Antarctica. *Science*, 286: 2138-2141.
- Junge, K., Eicken, H., and Deming, J. W., 2004: Bacterial activity at  $-2$  to  $-20^{\circ}\text{C}$  in Arctic wintertime sea ice. *Applied and Environmental Microbiology*, 70: 550-557.
- Kampfer, P., Erhart, R., Beimfohr, C., Bohringer, J., Wagner, M., and Amann, R., 1996: Characterization of bacterial communities from activated sludge: Culture-dependent numerical identification versus in situ identification using group- and genus-specific rRNA-targeted oligonucleotide probes. *Microbial Ecology*, 32: 101-121.
- Kapitsa, A. P., Ridley, J. K., Robin, G. d. Q., Siegert, M. J., and Zotikov, I. A., 1996: A large deep freshwater lake beneath the ice of central East Antarctica. *Nature*, 381: 684-686.
- Karl, D. M., Bird D. F., Björkman, K., Houlihan, T., Shackelford, R., and Tupas, L., 1999: Microorganisms in the accreted ice of Lake Vostok, Antarctica. *Science*, 286: 2144-2147.
- Kashefi, K. and Lovley, D. R., 2003: Extending the upper temperature limit for life. *Science*, 301: 934.
- Kennett, J. P., 1977: Cenozoic evolution of Antarctic glaciation, the circum-Antarctic ocean, and their impact on global paleoceanography. *Journal of Geophysical Research*, 82: 3843-3860.
- Killawee, J. A., Fairchild, I. J., Tison, J.-L., Janssens, L., and Lorrain, R., 1998: Segregation of solutes and gases in experimental freezing of dilute solutions: Implications for natural glacial systems. *Geochimica et Cosmochimica Acta*, 62: 3637-3655.
- Kimura, M., 1983: *The neutral theory of molecular evolutions*. Cambridge: Cambridge University Press, 384 pp.
- Kimura, M., 1989: The neutral theory of molecular evolution and the world view of the neutralists. *Genome*, 31: 24-31.
- Kling, G. W., Clark, M. A., and Compton, H. R., 1987: The 1986 Lake Nyos gas disaster in Cameroon, West Africa. *Science*, 236: 169-175.
- Konstantinidis, K. T. and Tiedje, J. M., 2005: Genomic insights that advance the species definition for prokaryotes. *Proceedings of the National Academy of Sciences of the United States of America*, 102: 2567-2572.
- Kormas, K. A., Smith, D. C., Edgcomb, V., and Teske, A., 2003: Molecular analysis of deep subsurface microbial communities in Nankai Trough sediments (ODP Leg 190, Site 1176). *FEMS Microbiology Ecology*, 45: 115-125.
- Larson, G. J., Lawson, D. E., Evenson, E. B., Alley, R. B., Knudsen, Ó., Lachniet, M. S., and Goetz, S. L., 2006: Glaciohydraulic supercooling in former ice sheets? *Geomorphology*, 75: 20-32.
- Lawrence, J. G. and Ochman, H., 1998: Molecular archaeology of the *Escherichia coli* genome. *Proceedings of the National Academy of Sciences of the United States of America*, 95: 9413-9417.
- Lawson, D. E., Strasser, J. C., Evenson, E. B., Alley, R. B., Larson, G. J., and Arcone, S. A., 1998: Glaciohydraulic supercooling: A freeze-on mechanism to create stratified, debris-rich basal ice: I. Field evidence. *Journal of Glaciology*, 44: 547-562.
- Lever, M. A., Alperin, M., Engelen, B., Inagaki, F., Nakagawa, S., Steinsbu, B. O., and Teske, A., 2006: Trends in basalt and sediment core contamination during IODP expedition 301. *Geomicrobiology Journal*, 23: 517-530.
- Levin, B. R. and Bergstrom, C. T., 2000: Bacteria are different: Observations, interpretations, speculations, and opinions about the mechanisms of adaptive evolution in prokaryotes. *Proceedings of the National Academy of Sciences of the United States of America*, 97: 6981-6985.

- Lipenkov, V. Y. and Istomin, V. A., 2001: On the stability of air clathrate-hydrate crystals in subglacial Lake Vostok, Antarctica. *Materialy Glyatsiologicheskikh Issledovaniy*, 91: 129-133.
- Liu, H., Jezek, K. C., and Li, B., 1999: Development of an Antarctic digital elevation model by integrating cartographic and remotely sensed data: A geographical information system based approach. *Journal of Geophysical Research*, 104: 23199-23213.
- Lubes, M., Lanseau, C., and Rémy, F., 2006: Relations between basal condition, subglacial hydrological networks and geothermal flux in Antarctica. *Earth and Planetary Science Letters*, 241: 655-662.
- Lythe, M. B., Vaughan, D. G., and BEDMAP Consortium, 2000: BEDMAP—bed topography of the Antarctic. 1:10,000,000 scale map, BAS (Misc) 9. Cambridge: British Antarctic Survey.
- Lythe, M. B. and Vaughan, D. G., 2001: BEDMAP: A new ice thickness and subglacial topographic model of Antarctica. *Journal of Geophysical Research-Solid Earth*, 106: 11335-11351.
- Ma, L.-J., Catranis, C. M., Starmer, W. T., and Rogers, S. O., 2005: The significance and implications of the discovery of filamentous fungi in glacial ice. In Castello, J. D. and Rogers, S. O. (eds.), *Life in Ancient Ice*. Princeton and Oxford: Princeton University Press, 159-180.
- Mancuso, C. A., Franzmann, P. D., Burton, H. R., and Nichols, P. D., 1990: Microbial community structure and biomass estimates of a methanogenic Antarctic lake ecosystem as determined by phospholipid analyses. *Microbial Ecology*, 19: 73-95.
- Martin, J. W., Smithwick, M. M., Braune, B. M., Hoekstra, P. F., Muir, D. C. G., and Mabury, S. A., 2004: Identification of long-chain perfluorinated acids in biota from the Canadian Arctic. *Environmental Science and Technology*, 38: 373-380.
- Martiny, J. B. H., Bohannon, B. J. M., Brown, J. H., Colwell, R. K., Fuhrman, J. A., Green, J. L., Horner-Devine, M. C., Kane, M., Krumins, J. A., Kuske, C. R., Morin, P. J., Naem, S., Øvreas, L., Reysenbach, A. L., Smith, V. H., and Staley, J. T., 2006: Microbial biogeography: putting microorganisms on the map. *Nature Reviews Microbiology*, 4: 102-112.
- Matthews, P. C. and Heaney, S. I., 1987: Solar heating and its influence on mixing in ice-covered lakes, 135-149.
- Mauchline, W. S. and Keevil, C. W., 1991: Development of the BIOLOG substrate utilization system for identification of *Legionella* spp. *Applied and Environmental Microbiology*, 57: 3345-3349.
- Maule, C. F., Purucker, M. E., Olsen, N., and Mosegaard, K., 2005: Heat flux anomalies in Antarctica revealed by satellite magnetic data. *Science*, 309: 464-467.
- Mayer, C. and Siegert, M. J., 2000: Numerical modeling of ice-sheet dynamics across the Vostok subglacial lake, central East Antarctica. *Journal of Glaciology*, 46: 197-205.
- Mayer, C., Grosfeld, K., and Siegert, M. J., 2003: Salinity impact on water flow and lake ice in Lake Vostok, Antarctica. *Geophysical Research Letters*, 30.
- Mayr, E., 1942: *Systematics and the Origin of Species from the Viewpoint of a Zoologist*. New York: Columbia University Press, 334 pp.
- Mazel, D., 2006: Integrons: Agents of bacterial evolution. *Nature Reviews Microbiology*, 4: 608-620.
- McKay, C. P., Hand, K. P., Doran, P. T., Anderson, D. T., and Prisco, J. C., 2003: Clathrate formation and the fate of noble and biologically useful gases in Lake Vostok, Antarctica. *Geophysical Research Letters*, 30.
- Miller, S. L., 1974: The nature and occurrence of clathrate. In Kaplan, I. R. (ed.), *Natural Gases in Marine Sediments*. New York: Plenum Press.
- Miteva, V. I., Sheridan, P. P., and Brenchley, J. E., 2004: Phylogenetic and physiological diversity of microorganisms isolated from a deep Greenland glacier ice core. *Applied and Environmental Microbiology*, 70: 202-213.
- Monismith, S. G., Imberger, J., and Morrison, M. L., 1990: Convective motions in the sidearm of a small reservoir. *Limnology and Oceanography*, 35: 1676-1702.
- Montagnat, M., Duval, P., Bastie, P., Hamelin, B., Brissaud, O., de Angelis, M., Petit, J.-R., and Lipenkov, V. Y., 2001: High crystalline quality of large single crystals of subglacial ice above Lake Vostok (Antarctica) revealed by hard X-ray diffraction. *Comptes Rendus de l'Academie des Sciences—Series IIA—Earth and Planetary Science*, 333: 419-425.
- Morita, R. Y., 1997: *Bacteria in Oligotrophic Environments. Starvation-Survival Lifestyle* New York: Chapman & Hall, 529 pp.
- Mueller, D. R., Vincent, W. F., Bonilla, S., and Laurion, I., 2005: Extremotrophs, extremophiles and broad-band pigmentation strategies in a high arctic ice shelf ecosystem. *FEMS Microbiology Ecology*, 53: 73-87.

- NASA, 1999: *Biological Contamination Control and Inbound Planetary Spacecraft*. NPD 8020.F. NASA, Washington, DC; Revalidated 10/23/03.
- NASA, 2005a: *Planetary Provisions for Robotic Extraterrestrial Missions*. NPR 8020.12C. NASA, Washington, DC.
- NASA, 2005b: *Standard procedures for the microbiological examination of space hardware*. NPR 5340.1C. NASA, Washington, DC.
- Nesbø, C. L., Dlutek, M., and Doolittle, W. F., 2006: Recombination in *Thermotoga*: implications for species concepts and biogeography. *Genetics*, 172: 759-769.
- NGICP, 2004: High-resolution record of Northern Hemisphere climate extending into the last interglacial period. *Nature*, 431: 147-151.
- NRC, 1986: *Antarctic Treaty System: an assessment*. Washington, DC: National Academy Press.
- NRC, 1993: *Science and Stewardship in the Antarctic*. Washington, DC: National Academy Press.
- NRC, 2006: *Preventing the Forward Contamination of Mars*. Washington, DC: National Academy Press.
- Ochman, H., Lawrence, J. G., and Grolsman, E. A., 2000: Lateral gene transfer and the nature of bacterial innovation. *Nature*, 405: 299-304.
- Page, R., Moy, K., Sims, E. C., Velasquez, J., McManus, B., Grittini, C., Clayton, T. L., and Stevens, R. C., 2004: Scalable high-throughput micro-expression device for recombinant proteins. *BioTechniques*, 37: 364-370.
- Parkes, R. J., Cragg, B. A., Bale, S. J., Getliff, J. M., Goodman, K., Rochelle, P. A., Fry, J. C., Welgthman, A. J., and Harvey, S. M., 1994: Deep bacterial biosphere in Pacific Ocean sediments. *Nature*, 371: 410-413.
- Pattyn, F., 2004: Comment on the comment by M. J. Siegert on "A numerical model for an alternative origin of Lake Vostok and its exobiological implications for Mars" by N. S. Duxbury et al. *Journal of Geophysical Research*, 109.
- Pedersen, K., 1993: The deep subterranean biosphere. *Earth-Science Reviews*, 34: 243-260.
- Pedros-Alio, C., 2007: Dipping into the rare biosphere. *Science*, 315: 192-193.
- Peplow, M., 2006: Ice core shows its age. <http://www.nature.com/news/2006/060123/full/060123-3.html>.
- Petit, J. R., Jouzel, J., Raynaud, D., Barkov, N. I., Barnola, J.-M., Basile, I., Bender, M., Chappellaz, J., Davis, M., Delaygue, G., Delmotte, M., Kotlyakov, V. M., Legrand, M., Lipenkov, V. Y., Lorius, C., Pépin, L., and Ritz, C., 1999: Climate and atmospheric history of the past 420,000 years from the Vostok ice core, Antarctica. *Nature*, 399: 429-436.
- Pollack, H. N., Hurter, S. J., and Johnson, J. R., 1993: Heat flow from the Earth's interior: analysis of the global data set. *Reviews of Geophysics*, 31: 267-280.
- Popkov, A. M., Kudryavtsev, G. A., Verkulich, S. R., Masolov, V. N., and Lukin, V., 1998: Seismic studies in the vicinity of Vostok Station (Antarctica). *Lake Vostok Study: Scientific Objectives and Technical Requirements*: 26.
- Price, P. B., 2000: A habitat for psychrophiles in deep Antarctic ice. *Proceedings of the National Academy of Sciences of the United States of America*, 97: 1247-1251.
- Price, P. B. and Sowers, T., 2004: Temperature dependence of metabolic rates for microbial growth, maintenance, and survival. *Proceedings of the National Academy of Sciences of the United States of America*, 101: 4631-4636.
- Price, P. B., 2007: Microbial life in glacial ice and implications for a cold origin of life. *FEMS Microbiology Ecology*, 59: 217-231.
- Priscu, J. C., Fritsen, C. H., Adams, E. E., Giovannoni, S. J., Paerl, H. W., McKay, C. P., Doran, P. T., Gordon, D. A., Lanoil, B. D., and Pinckney, J. L., 1998: Perennial Antarctic lake ice: An oasis for life in a polar desert. *Science*, 280: 2095-2098.
- Priscu, J. C., Adams, E. E., Lyons, W. B., Voytek, M. A., Mogk, R. L., Brown, R. L., McKay, C. P., Takacs, C. D., Welch, K. A., Wolf, C. F., Kirshtein, J. D., and Avcı, R., 1999: Geomicrobiology of subglacial ice above lake Vostok, Antarctica. *Science*, 286: 2141-2144.
- Priscu, J. C., Christner, B. C., Foreman, C. M., and Royston-Bishop, G., In press: Biological material in ice cores. *Encyclopedia of Quaternary Sciences*.
- Ragotzkie, R. A. and Likens, G. E., 1964: The heat balance of two Antarctic lakes. *Limnology and Oceanography*, 9: 412-425.
- Rehder, G., Kirby, S. H., Durham, W. B., Stern, L. A., Peltzer, E. T., Pinkston, J., and Brewer, P. G., 2004: Dissolution rates of pure methane hydrate and carbon-dioxide hydrate in undersaturated seawater at 1000-m depth. *Geochimica et Cosmochimica Acta*, 68: 285-292.

- Rémy, F., Testut, L., Legrésy, B., Forieri, A., Bianchi, C., and Tabacco, I. E., 2003: Lakes and subglacial hydrological networks around Dome C, East Antarctica. *Annals of Glaciology*, 37: 252-256.
- Rémy, F. and Legrésy, B., 2004: Subglacial hydrological networks in Antarctic and their impact on ice flow. *Annals of Glaciology*, 39: 67-72.
- Robin, G. d. Q., Swithinbank, C. W. M., and Smith, M. B. E., 1970: Radio echo exploration of the Antarctic Ice Sheet. International Symposium on Antarctic glaciological exploration (ISAGE). Hanover, New Hampshire, 3-7 September 1968. International Association of Scientific Hydrology, Publication No. 86, 97-115.
- Robin, G. d. Q., 1972: Polar ice sheets: A review. *Polar Record*, 16: 5-22.
- Rock, S. M. and Bratina, B. J., 2004: *Lake Vostok: Defining a technology roadmap for exploration and sampling*. NSF Sponsored Workshop, Palo Alto, CA.
- Rodionov, N., Belyatsky, B., Matukov, D., Antonov, A., Presnyakov, S., Leitchenkov, G., and Sergeev, S., 2006: First SHRIMP U-Th-Pb data on detrital zircons and monazite from ice drill core, Vostok lake, Antarctica (Abstract). *Goldschmidt Conference*.
- Rogers, S. O., Starmer, W. T., and Castello, J. D., 2004: Recycling of pathogenic microbes through survival in ice. *Medical Hypotheses*, 63: 773-777.
- Rothschild, L. J. and Mancinelli, R. L., 2001: Life in extreme environments. *Nature*, 409: 1092-1101.
- Rummel, J., 2006: Planetary Protection Policies, Procedures and Subglacial Lake Environments. *SALE-Advanced Science and Technology Planning Workshop*, 24-26 April, Grenoble, France.
- Russian Federation, 2006: *ATCM Information Paper 68: Russian studies of the subglacial Lake Vostok in the season of 2005-2006 and work plans for the season of 2006-2007*.
- Saito, F. and Abe-Ouchi, A., 2004: Thermal structure of Dome Fuji and east Dronning Maud Land, Antarctica, simulated by a three-dimensional ice-sheet model. *Annals of Glaciology*, 39: 433-438.
- SALEGOS, 2001: *Report of the Subglacial Antarctic Lake Exploration Group of Specialists, (SALEGOS), Meeting—I*, 29-30 November 2001, Bologna, Italy.
- Sambrotto, R. and Burckle, L., 2006: The nature and likely sources of biogenic particles found ancient ice from Antarctica. In Castello, J. D. and Rogers, S. O. (eds.), *Life in Ancient Ice*. Princeton and Oxford: Princeton University Press, 94-105.
- SCAR SALE, 2006: *Subglacial Antarctic Lake Environments in the International Polar Year 2007-08: Advanced Science and Technology Planning Workshop*, 24-25 April, Grenoble, France.
- Schink, B., 1997: Energetics of syntrophic cooperation in methanogenic degradation. *Microbiology and Molecular Biology Reviews*, 61: 262-280.
- Schink, B. and Stams, A. J. M., 2002: Syntrophism among prokaryotes. In Dworkin, M., Falkow, S., Rosenberg, E., Schleifer, K.-H., and Stackebrandt, E. (eds.), *The Prokaryotes: An Evolving Electronic Resource for the Microbiological Community*. New York: Springer Verlag.
- Schippers, A., Neretin, L. N., Kallmeyer, J., Ferdelman, T. G., Cragg, B. A., Parkes, R. J., and Jørgensen, B. B., 2005: Prokaryotic cells of the deep sub-seafloor biosphere identified as living bacteria. *Nature*, 433: 861-864.
- Shapiro, N. M. and Ritzwoller, M. H., 2004: Inferring surface heat flux distributions guided by a global seismic model: particular application to Antarctica. *Earth and Planetary Science Letters*, 223: 213-224.
- Shirtcliffe, T. G. L. and Benseman, R. F., 1964: A sun-heated Antarctic lake. *Journal of Geophysical Research*, 69: 3355-3359.
- Shoemaker, E. M., 2003: Effects of bed depressions upon floods from subglacial lakes. *Global and Planetary Change*, 35: 175-184.
- Shoham, D., 2005: Viral pathogens likely to be preserved in natural ice. In Castello, J. D. and Rogers, S. O. (eds.), *Life in Ancient Ice*. Princeton and Oxford: Princeton University Press, 208-226.
- Siegert, M. J. and Bamber, J. L., 2000: Subglacial water at the heads of Antarctic ice-stream tributaries. *Journal of Glaciology*, 46: 702-703.
- Siegert, M. J., Kwok, R., Mayer, C., and Hubbard, B., 2000: Water exchange between the subglacial Lake Vostok and the overlying ice sheet. *Nature*, 403: 643-646.
- Siegert, M. J., Ellis-Evans, J. C., Tranter, M., Mayer, C., Petit, J.-R., Salamatin, A., and Priscu, J. C., 2001: Physical, chemical and biological processes in Lake Vostok and other Antarctic subglacial lakes. *Nature*, 414: 603-609.
- Siegert, M. J., 2002: Which are the most suitable Antarctic subglacial lakes for exploration? *Polar Geography*, 26: 134-146.

- Siegert, M. J., Tranter, M., Ellis-Evans, J. C., Priscu, J. C., and Lyons, W. B., 2003: The hydrochemistry of Lake Vostok and the potential for life in Antarctic subglacial lakes. *Hydrological Processes*, 17: 795-814.
- Siegert, M. J., 2004: Comment on "A numerical model for an alternative origin of Lake Vostok and its exobiological implications for Mars" by N. S. Duxbury, I. A. Zotikov, K. H. Nealson, V. E. Romanovsky, and F. D. Carsey. *Journal of Geophysical Research*, 109: doi:10.1029/2003JE002176.
- Siegert, M. J., Hindmarsh, R., Corr, H., Smith, A., Woodward, J., King, E. C., Payne, A. J., and Joughin, I., 2004: Subglacial Lake Ellsworth: a candidate for *in situ* exploration in West Antarctica. *Geophysical Research Letters*, 31: doi:10.1029/2004GL021477.
- Siegert, M. J., 2005: Lakes beneath the ice sheet: The occurrence, analysis, and future exploration of Lake Vostok and other Antarctic subglacial lakes. *Annual Review of Earth and Planetary Sciences*, 33: 215-245.
- Siegert, M. J., Carter, S., Tabacco, I., Popov, S., and Blankenship, D. D., 2005a: A revised inventory of Antarctic subglacial lakes. *Antarctic Science*, 17: 453-460.
- Siegert, M. J., Taylor, J., and Payne, A. J., 2005b: Spectral roughness of subglacial topography and implications for former ice-sheet dynamics in East Antarctica. *Global and Planetary Change*, 45: 249-263.
- Siegert, M. J., Le Brocq, A., and Payne, A. J., 2007: Hydrological connections between Antarctic subglacial lakes, the flow of water beneath the East Antarctic Ice Sheet and implications for sedimentary processes. In Hambrey, M. J., Christoffersen, P., Glasser, N. F., and Hubbard, B. (eds.), *Glacial Processes and Products*: International Association of Sedimentologists.
- Sies, H., 1997: Oxidative stress: Oxidants and antioxidants. *Experimental Physiology*, 82: 291-295.
- Smith, A., Spivack, A. J., Fisk, M. R., Haveman, S. A., and Staudigel, H., and the Leg 185 Shipboard Scientific Party, 2000: Methods for quantifying potential microbial contamination during deep ocean coring. *ODP Technical Note*, 28, <http://www-odp.tamu.edu/publications/tnotes/tn28/INDEX.HTM>.
- Smith, A. W., Skilling, D. E., Castello, J. D., and Rogers, S. O., 2004: Ice as a reservoir for pathogenic human viruses: specifically, caliciviruses, influenza viruses, and enteroviruses. *Medical Hypotheses*, 63: 560-566.
- Sogin, M. L., Morrison, H. G., Huber, J. A., Welch, D. M., Huse, S. M., Neal, P. R., Arrieta, J. M., and Herndl, G. J., 2006: Microbial diversity in the deep sea and the underexplored "rare biosphere." *Proceedings of the National Academy of Sciences of the United States of America*, 103: 12115-12120.
- Souchez, R., Petit, J.-R., Tison, J.-L., Jouzel, J., and Verbeke, V., 2000: Ice formation in subglacial Lake Vostok, Central Antarctica. *Earth and Planetary Science Letters*, 181: 529-538.
- Souchez, R., Jean-Baptiste, P., Petit, J. R., Lipenkov, V. Y., and Jouzel, J., 2003: What is the deepest part of the Vostok ice core telling us? *Earth-Science Reviews*, 60: 131-146.
- Souchez, R., Petit, J. R., Jouzel, J., de Angelis, M., and Tison, J. L., 2004: Reassessing Lake Vostok's behavior from existing and new ice core data. *Earth and Planetary Science Letters*, 217: 163-170.
- Sowers, T., Miteva, V., and Brenchley, J., 2006: Assessing N<sub>2</sub>O anomalies in the Vostok ice core in terms of *in situ* N<sub>2</sub>O production by nitrifying organisms, Abstract L53. *International Conference on Alpine and Polar Microbiology*.
- Spiegelman, D., Whissell, G., and Greer, C. W., 2005: A survey of the methods for the characterization of microbial consortia and communities. *Canadian Journal of Microbiology*, 51: 355-386.
- Spigel, R. H. and Priscu, J. C., 1998: Physical limnology of the McMurdo Dry Valley lakes. In Priscu, J. C. (ed.), *Ecosystem Dynamics in a Polar Desert: The McMurdo Dry Valley Antarctica*. Antarctic Research Series, Vol. 72. Washington, DC: American Geophysical Institute, 153-187.
- Stackebrandt, E. and Goebel, B. M., 1994: Taxonomic note: A place for DNA-DNA reassociation and 16S rRNA sequence analysis in the present species definition in bacteriology. *International Journal of Systematic Bacteriology*, 44: 846-849.
- Staples, C. A., 2003: *Phthalate Esters*. Heidelberg: Springer-Verlag, 353 pp.
- Stern, L. A., Kirby, S. H., and Durham, W. B., 1996: Peculiarities of methane clathrate hydrate formation and solid-state deformation, including possible superheating of water ice. *Science*, 273: 1843-1848.
- Stern, L. A., Circone, S., Kirby, S. H., and Durham, W. B., 2001: Anomalous preservation of pure methane hydrate at 1 atm. *Journal of Physical Chemistry B*, 105: 1756-1762.
- Stern, L. A., Circone, S., Kirby, S. H., and Durham, W. B., 2003: Temperature, pressure, and compositional effects on anomalous or "self" preservation of gas hydrates. *Canadian Journal of Physics*, 81: 271-283.
- Stetter, K. O., 1996: Hyperthermophiles in the history of life. *CIBA Foundation Symposia*: 1-18.
- Stetter, K. O., 1999: Extremophiles and their adaptation to hot environments. *FEBS Letters*, 452: 22-25.

- Stohr, R., Waberski, A., Liesack, W., Volker, H., Wehmeyer, U., and Thomm, M., 2001: Hydrogenophilus hirschii sp nov., a novel thermophilic hydrogen-oxidizing beta proteobacterium isolated from Yellowstone National Park. *International Journal of Systematic and Evolutionary Microbiology*, 51: 481-488.
- Studinger, M., Bell, R. E., Karner, G. D., Tikku, A. A., Holt, J. W., Morse, D. L., Richter, T. G., Kempf, S. D., Peters, M. E., Blankenship, D. D., Sweeney, R. E., and Rystrom, V. L., 2003a: Ice cover, landscape setting, and geological framework of Lake Vostok, East Antarctica. *Earth and Planetary Science Letters*, 205: 195-210.
- Studinger, M., Karner, G. D., Bell, R. E., Levin, V., Raymond, C. A., and Tikku, A. A., 2003b: Geophysical models for the tectonic framework of the Lake Vostok region, East Antarctica. *Earth and Planetary Science Letters*, 216: 663-677.
- Studinger, M., Bell, R. E., and Tikku, A. A., 2004: Estimating the depth and shape of subglacial Lake Vostok's water cavity from aerogravity data. *Geophysical Research Letters*, 31: doi:10.1029/2004GL019801.
- Tabacco, I. E., Cianfarra, P., Forieri, A., Salvini, F., and Zirizotti, A., 2006: Physiography and tectonic setting of the subglacial lake district between Vostok and Belgica subglacial highlands (Antarctica). *Geophysical Journal International*, 165: 1029-1040.
- Takacs, C. D. and Priscu, J. C., 1998: Bacterioplankton dynamics in the McMurdo Dry Valley lakes, Antarctica: production and biomass loss over four seasons. *Microbial Ecology*, 36: 239-250.
- Tally, F. P., Stewart, P. R., Sutter, V. L., and Rosenblatt, J. E., 1975: Oxygen tolerance of fresh clinical anaerobic bacteria. *Journal of Clinical Microbiology*, 1: 161-164.
- Thomas, D. N. and Dieckmann, G. S., 2002: Antarctic sea ice—A habitat for extremophiles. *Science*, 295: 641-644.
- Tiedje, J. M., 1999: Exploring microbial life in Lake Vostok. In Bell, R. E. and Karl, D. M. (eds.), *Lake Vostok Workshop: Final Report*. Palisades, NY: Lamont-Doherty of Columbia University, 19-21.
- Tikku, A. A., Bell, R. E., Studinger, M., and Clarke, G. K., 2004: Ice flow field over Lake Vostok, East Antarctica inferred by structure tracking. *Earth and Planetary Science Letters*, 227: 249-261.
- Tikku, A. A., Bell, R. E., Studinger, M., Clarke, G. K. C., Tabacco, I., and Ferraccioli, F., 2005: Influx of meltwater to subglacial Lake Concordia, East Antarctica. *Journal of Glaciology*, 51: 96-104.
- Tranvik, L. J. and Bertilsson, S., 2001: Contrasting effects of solar UV radiation on dissolved organic sources for bacterial growth. *Ecology Letters*, 4: 458-463.
- Tsuneyoshi, I., Boyle Iii, W. A., Kanmura, Y., and Fujimoto, T., 2001: Hyperbaric hyperoxia suppresses growth of Staphylococcus aureus, including methicillin-resistant strains. *Journal of Anesthesia*, 15: 29-32.
- Tung, H. C., Price, P. B., Bramall, N. E., and Vrdoljak, G., 2006: Microorganisms metabolizing on clay grains in 3 km-deep Greenland basal ice. *Astrobiology*, 6: 69-86.
- Tyler, S. W., Cook, P. G., Butt, A. Z., Thomas, J. M., Doran, P. T., and Lyons, W. B., 1998: Evidence of deep circulation in two perennially ice-covered Antarctic lakes. *Limnology and Oceanography*, 43: 625-635.
- U.S. Department of State, 2002: *Handbook of the Antarctic Treaty System 9th Ed.* Washington, DC: U.S. Department of State.
- Uchida, T. and Hondoh, T., 2000: Laboratory studies on air-hydrate crystals. In Hondoh, T. (ed.), *Physics of Ice Core Records*: Hokaido University, 423-427.
- United Nations, 1997: *Treaty on Principles Governing the Activities of States in the Exploration and Use of Outer Space, including the Moon and other Celestial Bodies*. United Nations, Doc A/RES/222(XXI); TIAS No. 6347, New York.
- Van Hove, P., Belzile, C., Gibson, J. A. E., and Vincent, W. F., 2006: Coupled landscape-lake evolution in High Arctic Canada. *Canadian Journal of Earth Sciences*, 43: 533-546.
- Vincent, W. F., 1988: *Microbial Ecosystems of Antarctica*. U. K.: Cambridge University Press, 304 pp.
- Vincent, W. F., Gibbs, M. M., and Spigel, R. H., 1991: Eutrophication processes regulated by a plunging river inflow. *Hydrobiologia*, 226: 51-63.
- Vincent, W. F. and Howard-Williams, C., 1994: Nitrate rich inland waters of the Ross Ice Shelf Region, Antarctica. *Antarctic Science*, 6: 339-346.
- Vincent, W. F., 1996: *Environmental Management of a Cold Desert Ecosystem: the McMurdo Dry Valleys, Antarctica*: Desert Research Institute, University of Nevada, Special Publication, 55 pp.
- Vincent, W. F., 2000: Evolutionary origins of Antarctic microbiota: invasion, selection and endemism. *Antarctic Science*, 12: 374-385.

- Von Stockar, U., Maskow, T., Liu, J., Marison, I. W., and Patino, R., 2005: Thermodynamics of microbial growth and metabolism: an analysis of the current situation. *Journal of Biotechnology*, 121: 517-533.
- Vreeland, R. H., Piselli Jr., A. F., McDonnough, S., and Meyers, S. S., 1998: Distribution and diversity of halophilic bacteria in a subsurface salt formation. *Extremophiles*, 2: 321-331.
- Vreeland, R. H., Rosenzweig, W. D., and Powers, D. W., 2000: Isolation of a 250 million-year-old halotolerant bacterium from a primary salt crystal. *Nature*, 407: 897-900.
- Walsh, D., 2002: A note on eastern-boundary intensification of flow in Lake Vostok. *Ocean Modelling*, 4: 207-218.
- Ward, N. and Fraser, C. M., 2005: How genomics has affected the concept of microbiology. *Current Opinion in Microbiology*, 8: 564-571.
- Wayne, L. G., Brenner, D. J., Colwell, R. R., Grimont, P. A. D., and Kandler, O., 1987: Report of the ad hoc committee on reconciliation of approaches to bacterial systematics. *International Journal of Systematic Bacteriology*, 37: 463-464.
- Weertman, J., 2002: The Comninou–Dundurs effects and position stability of subglacial lakes. *Annals of Glaciology*, 35: 495-502.
- Wendt, A., Dietrich, R., Wendt, J., Fritsche, M., Lukin, V., Yuskevich, A., Kokhanov, A., Senatorov, A., Shibuya, K., and Doi, K., 2005: The response of the subglacial Lake Vostok, Antarctica, to tidal and atmospheric pressure forcing. *Geophysical Journal International*, 161: 41-49.
- Wetzel, R. G., 2001: *Limnology: Lake and River Ecosystems 3rd Edition*. New York: Academic Press, 1006 pp.
- Wharton, R. A., McKay, C. P., Simmons, G. M., and Parker, B. C., 1986: Oxygen budget of a perennially ice-covered Antarctic lake. *Limnology and Oceanography*, 31: 437-443.
- Wharton, R. A. and Doran, P. T., 1999: *McMurdo Dry Valley Lakes: Impacts of Research Activities*: Desert Research Institute, University of Nevada, Special Publication, 54 pp.
- Wigfield, Y. Y., Lacroix, M. D., Lanouette, M., and Gurprasad, N. P., 1988: Gas chromatographic determination of N-nitrosodialkanolamines in herbicide Di- or trialkanolamine formulations. *Journal of the Association of Official Analytical Chemists*, 71: 328-333.
- Williams, M. J. M., 2001: Application of a three-dimensional numerical model to Lake Vostok: An Antarctic subglacial lake. *Geophysical Research Letters*, 28: 531-534.
- Wingham, D. J., Siegert, M. J., Shepherd, A., and Muir, A. S., 2006: Rapid discharge connects Antarctic subglacial lakes. *Nature*, 440: 1033-1036.
- Wondzell, S. M., 2006: Effect of morphology and discharge on hyporheic exchange flows in two small streams in the Cascade Mountains of Oregon, USA. *Hydrological Processes*, 20: 267-287.
- Wüest, A. and Carmack, E., 2000: A priori estimates of mixing and circulation in the hard-to-reach water body of Lake Vostok. *Ocean Modelling*, 2: 29-43.
- Xu, J., 2006: Microbial ecology in the age of genomics and metagenomics: Concepts, tools, and recent advances. *Molecular Ecology*, 15: 1713-1731.
- Yayanos, A. A., 1995: Microbiology to 10,500 meters in the deep sea. *Annual Review of Microbiology*, 49: 777-805.

# Appendixes





## A

## Statement of Task

This study will address the environmental and scientific protection standards needed to responsibly explore the subglacial lake environments found under continental-scale ice sheets. The motivations for this study are ensuring wise stewardship of these unique environments, including strict observance of environmental protection responsibilities under domestic and international laws and treaties, as well as determining how to collect the best possible samples for scientific study while minimizing site contamination and ensuring preservation for future scientific inquiry. The scientific rationale for setting standards will be developed and reported in a manner credible to the widest range of stakeholders and interested parties, including those from the international community. This rationale will provide important guidance for developing, testing, and verifying sensor deployment and sampling protocols to balance the value of the scientific information to be gained against the potential for alteration and/or contamination of the sites being studied.

Specifically, the committee will:

1. Define levels of “cleanliness” for equipment/devices entering subglacial lake environments necessary to assure that the environments are subject to minimal, reversible, or acceptable change caused by the introduction of either naturally occurring earth surface materials and life forms or anthropogenic substances.

Developing a sound scientific basis for contamination standards will require a number of steps. These include delineation of the most likely sources of contamination, description of methods that might be used to reduce these introductions (e.g., physical cleaning, sterilization, and coating of surfaces with anti-fouling materials), and discussion of methodologies that might be used to demonstrate that the acceptable levels of “cleanliness” have been achieved. This analysis should recognize that different stages of exploration may be subject to differing levels of environmental concern and that some activities have been reviewed and approved for use elsewhere. The committee will consider the protocols developed for planetary protection over the past 40 years by NASA and assess their utility, applicabil-

ity, transferability, and adaptability to subglacial lake environment exploration and research.

2. Recommend next steps needed to define an overall exploration strategy. The committee will use existing planning documents and lessons learned from previous activities that have penetrated and potentially contaminated subglacial environments as a starting point. The committee will consider (a) the merits and disadvantages of existing technology with respect to contamination, highlighting additional technological development that is needed, (b) procedures and additional scientific studies to ensure that the best available environmentally and scientifically sound practices are adhered to and contamination risks are reduced to acceptable levels during the entry and sampling of subglacial lake environments, (c) the costs and benefits in terms of scientific outcomes of exploring now versus later, and (d) potential targets among the many Antarctic lakes.

## B

## Biographical Sketches of Committee Members

**Dr. John E. Hobbie** is a distinguished scientist at the Marine Biological Laboratory in Woods Hole, Massachusetts, and former director of its Ecosystem Center. He also leads the Arctic Long Term Ecological Research Project of the National Science Foundation. His research interests include arctic and antarctic limnology, estuarine ecology, and the global carbon cycle. Over 30 years ago, Dr. Hobbie began studying the role of natural assemblages of microbes in ecosystems, leading him to develop and apply methods for measuring the kinetics of uptake of organic compounds by bacteria using radiolabelled substrates. He later developed methods for measuring the mineralization of organic compounds to CO<sub>2</sub> and for visualizing and enumerating bacteria present in natural water samples using DNA specific stains. He also studies larger systems in estuaries and arctic tundra lakes. He has served as a member of the NRC's Ocean Studies Board and the Polar Research Board as well as on several other NRC committees, including the Committee to Review Community Development Quotas (Chair) and the Committee on Health and Ecological Effects of Synfuels Industries (Vice Chair). Dr. Hobbie received his doctorate in zoology in 1962 from Indiana University. He is chair of this committee because of his international stature as a polar scientist, his prior chairing experience with NRC, and his lack of involvement with subglacial lake exploration to date.

**Ms. Amy Baker** is the owner of Technical Administrative Services (TAS), a technically based service organization that provides technical and administrative support focusing specifically on the needs of the international scientific community. Over the past 6 years under TAS auspices she has participated in research for new biological methods that are currently under development for supplemental inclusion in NASA's planetary protection procedures. As senior engineer with Lockheed Martin Astronautics, Ms. Baker worked as the Technical Lead for the Planetary Protection Laboratory for the Mars Surveyor Program and the Chemical Technology Laboratory. During her tenure with the National Renewable Energy Laboratory she served as the Deputy Director for the Hydrogen Research Program for the Department of Energy. Ms. Baker was also the Secretariat to the International Energy Agency Executive

Committee on Hydrogen Research. She completed her B.S. in Chemistry in 1985 at the University of Wyoming. Ms. Baker is suited to the committee due to her expertise in cleaning spacecraft (e.g., swabbing and culturing) in preparation for missions and knowledge of contamination prevention in general.

**Dr. Garry Clarke** is a professor of geophysics in the Department of Earth and Ocean Sciences at the University of British Columbia. His research specialty is glaciology and his particular expertise is in subglacial physical processes, subglacial hydrology, the stability of glaciers and ice sheets, and cryospheric agents of abrupt climate change. He has spearheaded a 35-year glaciological field study in the Yukon Territory, Canada, that involves drilling and extensive use of subglacial instrumentation. He is also active in the development of theory and computational models of glacier and ice sheet dynamics. Dr. Clarke has served as President of the International Glaciological Society and the Canadian Geophysical Union and received the highest scientific awards of both these organizations. He is a Fellow of the Royal Society of Canada, the American Geophysical Union, and the Arctic Institute of North America. He currently serves on the editorial board of *Quaternary Science Reviews* and is an Associate Editor of the *Journal of Geophysical Research*. He previously served on the NRC's Committee on Glaciology. Dr. Clarke received his doctorate in physics in 1967 from the University of Toronto. His breadth and depth of knowledge in glaciology and subglacial processes bear directly on the study topic. In addition to theoretical knowledge, he brings many years of practical experience of drilling and sampling in subglacial environments.

**Dr. Peter T. Doran** is an associate professor and graduate director in the Earth and Environmental Sciences department at the University of Illinois at Chicago (UIC). His research is based in east Antarctica as part the multidisciplinary Long Term Ecological Research (LTER) site in the McMurdo Dry Valleys. He also carries out NASA-funded research using the dry valleys as analogs for past environments on Mars. He is currently lead-PI on a NASA-funded project to test a planetary drill in an ice-sealed dry valley lake. External committee experience includes being a sitting member and current chair of the National Science Foundation's McMurdo Area Users Committee and past member of two NASA review panels. He is also an associate editor on the *Journal of Geophysical Research Biogeosciences*. Dr. Doran received his doctorate in Hydrology/Hydrogeology from the University of Nevada, Reno. His practical knowledge of sampling challenges and methodologies in cold environments and his knowledge of community discussions and planning for drilling and sampling of subglacial environments are particularly relevant to this study.

**Dr. David Karl** is a professor of oceanography at the University of Hawaii. His research interests include marine microbial ecology, biogeochemistry, long-term time-series studies of climate and ecosystem variability, and the ocean's role in regulating the global concentration of CO<sub>2</sub> in the atmosphere. Dr. Karl was elected to the National Academy of Sciences in 2006 and he currently serves on the *Proceedings of the National Academy of Sciences* Editorial Board. He has been a member of the Polar Research Board and has served on the NRC's Committee on a Science Plan for the North Pacific Research Board and the Planning Committee for the International Polar Year 2007-2008, Phase 2. He received his doctorate in oceanography in 1978 from the Scripps Institution of Oceanography at the University of California, San Diego. Dr. Karl has expertise in

microbial life in extreme environments and his knowledge of planning and community discussions on exploring subglacial environments.

**Dr. Barbara Methé** is an assistant investigator in the Department of Microbial Genomics at The Institute for Genomic Research (TIGR) in Rockville, Maryland, where she has been since 2000 first as a visiting scientist and then as a collaborative investigator. Dr. Methé's research interests center on the application of genomic, functional genomic, and metagenomic approaches to the study of microbial diversity and metabolism and their impacts on the environment. In 2003, she was a member of the BO-037 Project at Palmer Station Antarctica, which included fish collection on the R/V *Laurence M. Gould*. Since 2003, Dr. Methé has been a member of the organizing committee to develop the program on Microbial Environmental Genomics (MicroEnGen) as part of the Scientific Committee on Problems of the Environment (SCOPE). Dr. Methé received her doctorate in Environmental Engineering in 1998 from Rensselaer Polytechnic Institute. She has expertise in genomics and its applications to sampling and studying cold-environment microbes.

**Dr. Heinz Miller** is a professor of geophysics at the Alfred-Wegener-Institute for Polar and Marine Research. His research interests range from polar geophysics (marine and terrestrial) to paleoclimate studies from ice cores. Dr. Miller has extensive experience with the Scientific Committee on Antarctic Research (SCAR) serving as a member of the Glaciology Working Group from 1984 to 2002 and chair from 1990 to 1998, member of the Group of Specialists on Environmental Affairs and Conservation from 1988 to 2002, chair of the first workshop on Lake Vostok, and he was the initial chair of the Group of Specialists on Subglacial Lakes. He was the coordinator of the European Project for Ice Coring in Antarctica (EPICA) ice core program and chair of the EPICA Science Steering Committee. Dr. Miller also is on the Member Council of Managers of National Antarctic programs. He has extensive field experience both in the Arctic and Antarctica and has participated in various deep ice core drilling campaigns. Dr. Miller received his doctorate in geophysics in 1972 from the University of Munich. He has experience with deep drilling through ice sheets and familiarity with drilling technology.

**Dr. Samuel B. Mukasa** is a professor in the Department of Geological Sciences at the University of Michigan, where he has been on the faculty since 1989. In 1985-1989, he was an assistant professor in the Department of Geology at the University of Florida. Dr. Mukasa's research interests include the geologic evolution of the Antarctic lithosphere and the integrated use of trace elements and Pb, Nd, Sr, Hf, and Os isotopes to model the evolution and dynamics of Earth's mantle. He served as the chair of NSF's Advisory Board for the Office of Polar Programs during 1994-1997, and on NSF's Polar Geology and Geophysics Panel during 1992-1994. He also served as Associate Editor for the *Geological Society of America Bulletin* in 1995-1998. Dr. Mukasa received his doctorate in geochemistry in 1984 from the University of California, Santa Barbara, and his postdoctoral research fellowship at the Lamont-Doherty Earth Observatory of Columbia University in Palisades, New York. He is nominated to the committee for his knowledge of the geologic setting and its influence on subglacial lake physical and chemical characteristics.

**Dr. Margaret Race** is an ecologist currently working with NASA through the Search for Extraterrestrial Intelligence (SETI) Institute. Dr. Race's research interests focus on environmental impacts, legal and policy issues, and risk communication related to solar system exploration and the search for extraterrestrial life. She is also a research affiliate with the Energy and Resources Group at University of California at Berkeley. She is currently serving on the NRC Committee on Preventing the Forward Contamination of Mars and has previously served on four other committees, including the Task Group on Sample Return from Small Solar System Bodies and the Study on Transportation and a Sustainable Environment. Dr. Race received her doctorate in zoology from UC Berkeley. She is nominated to the committee for her direct connection to related activities in the NRC's Space Studies Board and her expertise in astrobiological issues surrounding solar system exploration and potential parallels to the challenges faced in this study.

**Dr. Warwick F. Vincent** is a professor of biology and holds the Canada research chair in aquatic ecosystem studies at Laval University in Quebec City, Canada, where he has been in a faculty position since 1990. He has conducted ecological research on lakes, rivers, and coastal oceans in several parts of the world, including the subtropical convergence (South Pacific), Lake Titicaca (Peru-Bolivia), Lake Biwa (Japan), and the St. Lawrence River. Most of Dr. Vincent's research has focused on the polar regions, with his first expedition to Antarctica in 1979. Working with the National Science Foundation and Antarctica New Zealand, he played an early role in the environmental protection of the McMurdo Dry Valleys of Antarctica. He is a contributing author to the Arctic Climate Impact Assessment, is subprogram leader (microbial ecology) within the Canada Arctic Shelf Exchange Study, and leads freshwater-terrestrial components of the research network ArcticNet. He is the past president of Canada's National Antarctic Committee. Dr. Vincent received his doctorate in ecology from the University of California at Davis. His expertise in environmental protection policy and stewardship and specifically his knowledge of cold regions' microbial ecology are particularly relevant to this study.

**Dr. David Walton** is a professor at the British Antarctic Survey (BAS), where he headed the Environment and Information Division from 1999 to 2006. He was responsible for all environmental management and conservation activities, mapping, databases, and information management, as well as establishing the Artists & Writers Programme. He joined BAS in 1967 as a research scientist and worked on a range of ecological projects until 1986. He established the new Terrestrial & Freshwater Life Sciences Division in 1986 and ran it until re-organization in 1998 led to his establishing the new division on Environment and Information (EID). Primarily as an ecologist, Dr. Walton has made seventeen Antarctic visits. He has served as chair of the SCAR Group of Specialists on Environmental Affairs and Conservation from 1992 and then as chair of the SCAR Antarctic Treaty Standing Committee from 2002. As Head of the SCAR Delegation to Antarctic Treaty Consultative Meetings since 1992 he has gained considerable experience of linking science and policy at an international level. He was awarded the first SCAR Medal for International Scientific Co-ordination in 2006. He is Editor in Chief of the international journal *Antarctic Science* which he established 18 years ago. Dr. Walton received his doctorate in ecology in 1974 from Birmingham University in the UK. He is familiar with the Antarctic Treaty System and environmental protection and stewardship in general.

**Dr. James White** is a professor of Geological Sciences and of Environmental Studies at the University of Colorado at Boulder, where he is also a Fellow at the Institute of Arctic and Alpine Research (INSTAAR) and past director of the Environmental Studies Program. His research interests at the Light Stable Isotope Laboratory include global scale climate and environmental dynamics, carbon dioxide concentrations and climate from stable hydrogen isotopes, peats, and other organics, climate from deuterium excess and hydrogen isotopes in ice cores, isotopes in general circulation models, and modern carbon cycle dynamics via isotopes of carbon dioxide and methane. Dr. White has served on the Global Change Subcommittee, Planning Group 2, of SCAR from 1993 to 1996 and as a member of the U.S. Ice Core Working Group from 1989 to 1992, after which he was the Chair from 1992 to 1996. He has served on the Polar Research Board of the National Research Council since May 2005. Dr. White received his doctorate in Geological Sciences in 1983 from Columbia University. He has knowledge of ice-sheet geochemistry and in particular of the materials that may enter subglacial environments from the overlying ice.



## C

## List of Acronyms

AARI	Arctic and Antarctic Research Institute
ANDRILL	Antarctic Geological Drilling
AO	Acridine Orange
APC	Advanced Piston Corer
ASMA	Antarctic Specially Managed Area
ASPA	Antarctic Specially Protected Area
ATCM	Antarctic Treaty Consultative Meeting
ATLO	Assembly Test and Launch
AUV	Autonomous Underwater Vehicle
AWI	Alfred Wegener Institute
BAS	British Antarctic Survey
BEQ	Biological Energy Quantum
CCAMLR	Commission for the Conservation of Antarctic Living Marine Resources
CEE	Comprehensive Environmental Evaluation
CEP	Committee for Environmental Protection
COMNAP	Council of Managers of National Antarctic Programs
COSPAR	International Committee on Space Research
CRREL	Cold Regions Research and Engineering Laboratory
CTDI	Coiled-Tube Drilling for Ice
DAPI	4',6-Diamidino-2-phenylindole
DEM	Digital Elevation Model
DGGE	Denaturing Gradient Gel Electrophoresis
DML	Dronning Maud Land
DOC	Dissolved Organic Carbon
DSDP	Deep Sea Drilling Program

EAIS	East Antarctic Ice Sheet
EPICA	European Project for Ice Coring in Antarctica
FISH	Fluorescence In Situ Hybridization
FOSA	Heptadecafluorooctane Sulfonamide
GC-MS	Gas Chromatography-Mass Spectroscopy
GISP	Greenland Ice Sheet Project
GRIP	Greenland Ice Core Project
HCFC	Hydrochlorofluorocarbon
ICSU	International Council for Science
IEE	Initial Environmental Evaluation
IGY	International Geophysical Year
IODP	Integrated Ocean Drilling Program
IPEV	French Polar Institute
IPY	International Polar Year
LC-MS	Liquid Chromatography-Mass Spectroscopy
ME	Maintenance Energy
MPa	Megapascal
NAC	NASA Advisory Council
NASA	National Aeronautics and Space Administration
NDELA	Nitrosodiethanolamine
NGRIP	North Greenland Ice Core Project
NIPR	National Institute of Polar Research
NPOC	Non-purgeable Organic Carbon
NPR	NASA Procedural Requirement
NRC	National Research Council
NSF	National Science Foundation
NTU	Nephelometric Turbidity Unit
ODP	Ocean Drilling Program
OPP	Office of Polar Programs
PFT	Perfluorocarbon Tracer
PNRA	National Research Program in Antarctica
POC	Particulate Organic Carbon
PP	Planetary Protection
PPP	Panel on Planetary Protection
PVC	Polyvinyl Chloride
RCB	Rotary Core Barrel
RES	Radio-Echo Sounding
ROS	Reactive Oxygen Species

ROV	Remotely Operated Vehicle
SALE	Subglacial Antarctic Lake Exploration
SALEGOS	Subglacial Antarctic Lake Exploration Group of Specialists
SAR	Synthetic Aperture Radar
SCAR	Scientific Committee on Antarctic Research
SRP	Scientific Research Plan
SSB	Space Studies Board
TDS	Total Dissolved Solids
T-RFLP	Terminal Restriction Fragment Length Polymorphism
UNITED	Unified Team for Exploration and Discovery
U.S. SALE	U.S. Subglacial Lake Environments
WAIS	West Antarctic Ice Sheet