



AUV PAUL3000

Polar autonomous underwater laboratory

AWI's AUV project

Feb. 2021

FRAM

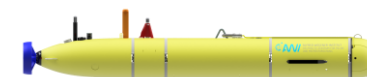

Introduction

- Team

- Sascha Lehmenhecker
- Autun Purser (Scientific Lead)
- Michael Busack (Tech. Lead)
- Jonas Hagemann

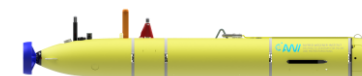

Introduction

- History
 - Purchased in 2003

Bluefin Robotics Type Odysse III

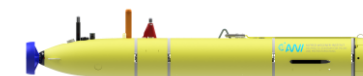

- Team
- History

Introduction

- History

- 2003: Purchased

- Specs:

- Length: 3.2 – 4 m
 - Weight: 150 kg
 - Power: 2 kWh Li-Po
 - Depth: 3000 m

- Instruments

- 2 x magnetic compass
 - Forward-looking sonar
 - DVL

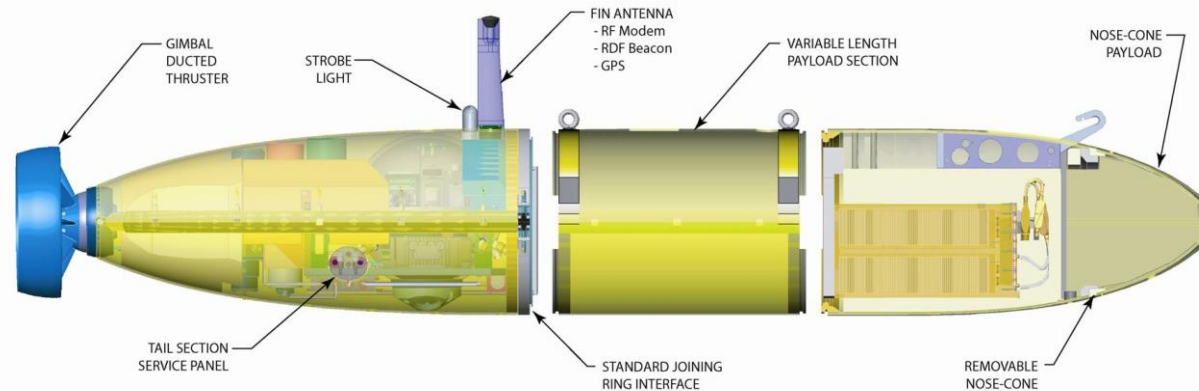

Introduction

- Team
- History

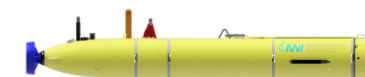

Introduction

- History
 - 2003 - 2007
 - Bad navigation
 - Problem with sensors

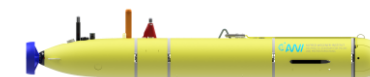

- Team
- History

Introduction

Introduction

- Team
- History

- History
 - 2008: Update
 - INS
 - Benthos-Modem

**U.S. Department of State
UNITED STATES OF AMERICA
NONTRANSFER AND USE CERTIFICATE**

1. Name of United States recipient: **Bathyn Robotics Corporation**

2. Name of foreign end-user: **Alfred Wegener Institut**

3. Country of ultimate destination: **Germany**

4. Description of article: **Autonomous Underwater Vehicle (AUV) previously exported under a Restricted License number 889780. Upgraded to include a Real-time Thermal Navigation System (RTNS)**

5. Quantity: **1**

6. Value (U.S. \$): **\$981,470**

7. Signature of Official, Foreign Consignee: *Michael Klagen*

8. Signature of Government Official: *[Signature]*

9. Signature of Applicant: *[Signature]*

Date Signed: **02-11-2007**

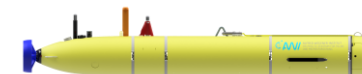

Introduction

- History
 - 2011: Re-Design
 - Battery-Section
 - Ice shift tracking
 - Portable GPS tracker

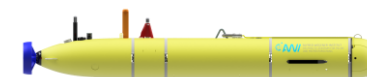
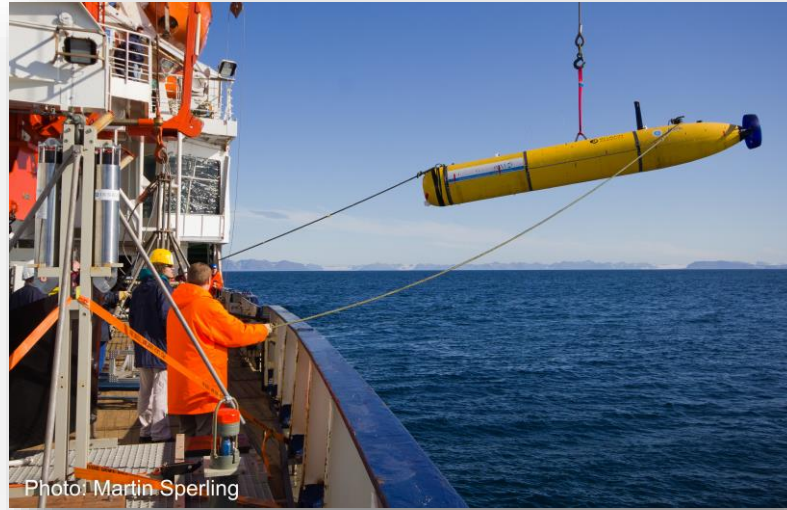

- Team
- History

Introduction

- History
 - 2012: Additional Equipment
 - Orange fin
 - Ice shift tracking
 - Drone V1

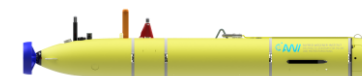

- Team
- History

Introduction

- History
 - 2013: Additional Equipment
 - Iridium
 - Ice shift tracking
 - Drone V2

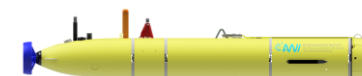
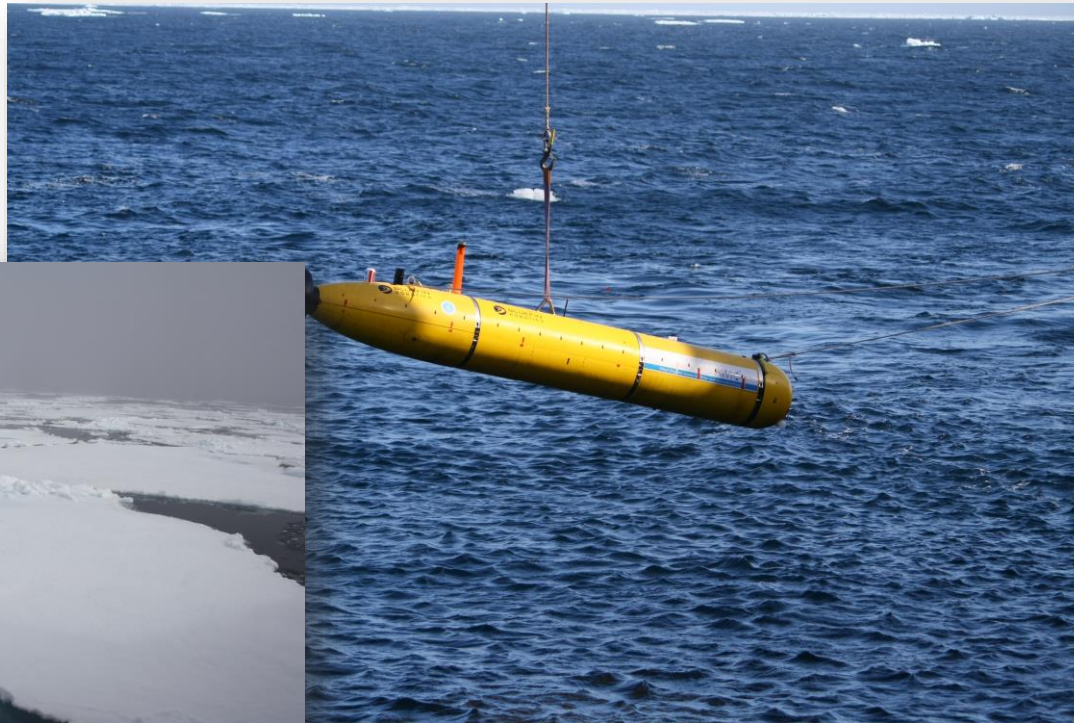

- Team
- History

Introduction

- History
 - 2015: Additional Equipment
 - Drone V3

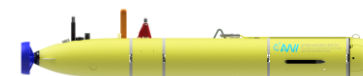

Introduction

- History
 - 2018

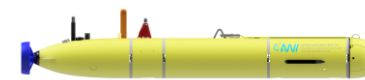

- Team
- History

Introduction

- History

- Today

- Specs:

- Length: 4.3 - 4.7m
 - Weight: 400 – 600 kg
 - Power: 7.5 kWh Li-Ion
 - Depth: 3000 m

- Instruments

- INS
 - DVL
 - 2 x Iridium / GPS
 - 2 x Strobe
 - USBL

BF-21

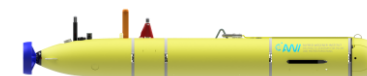
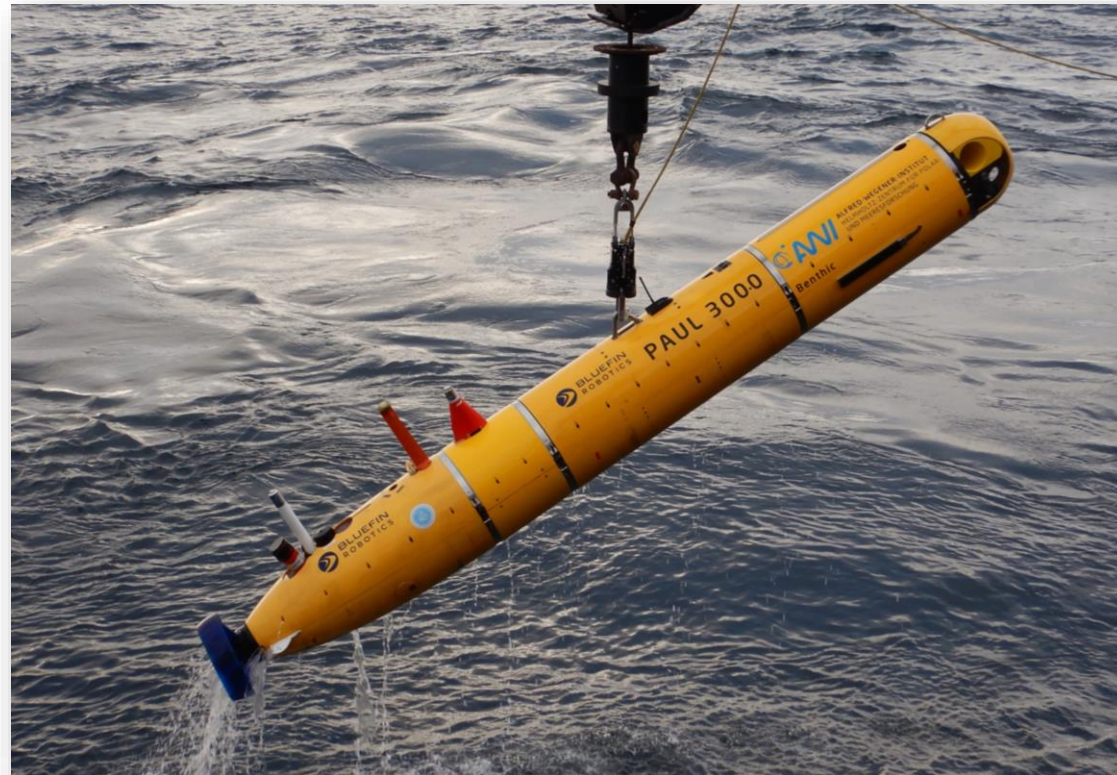

- Team
- History

Payload

- Highly modular
- 2 different payloads
 - Pelagic
 - Benthic

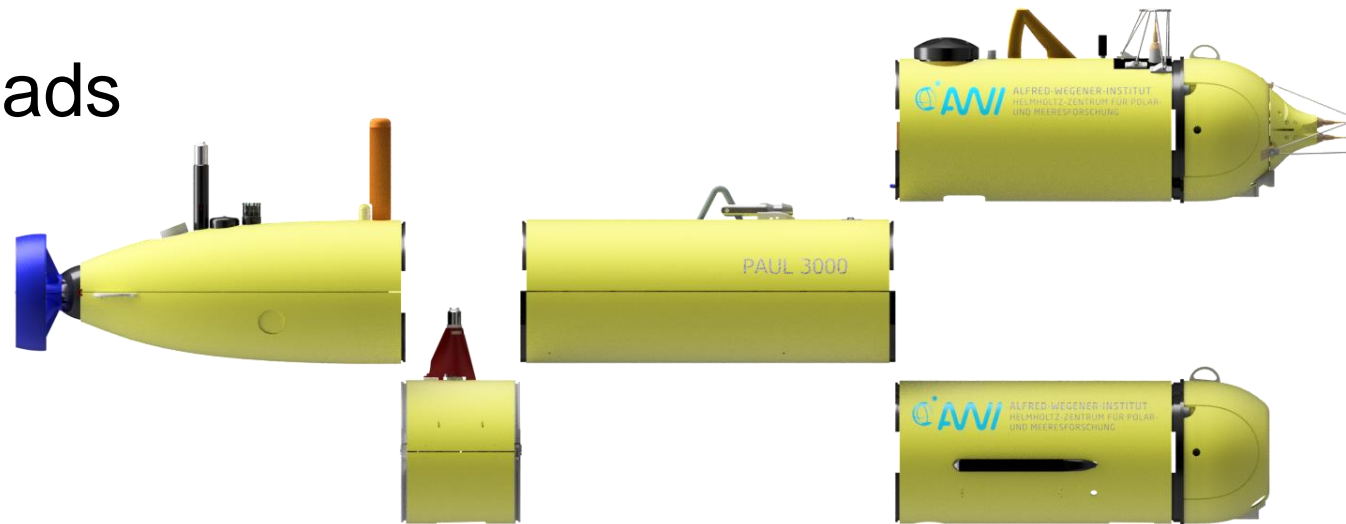

Introduction

- Team
- History

Payload

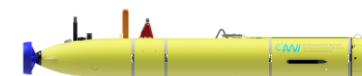

Payload

- Pelagic

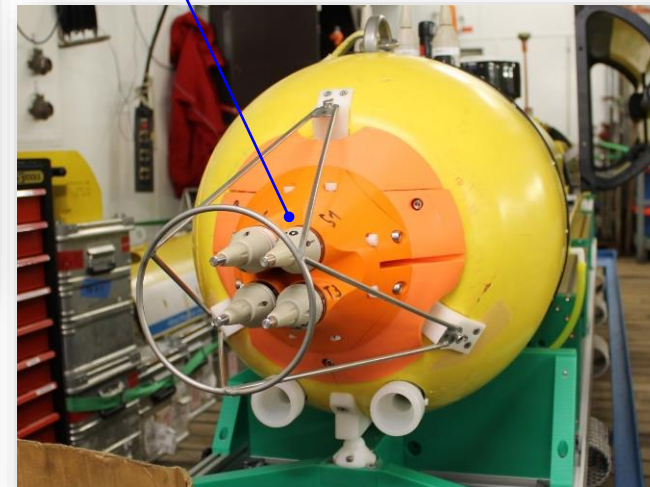
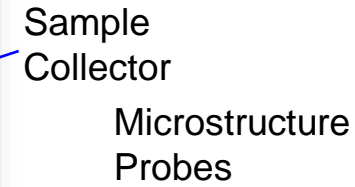
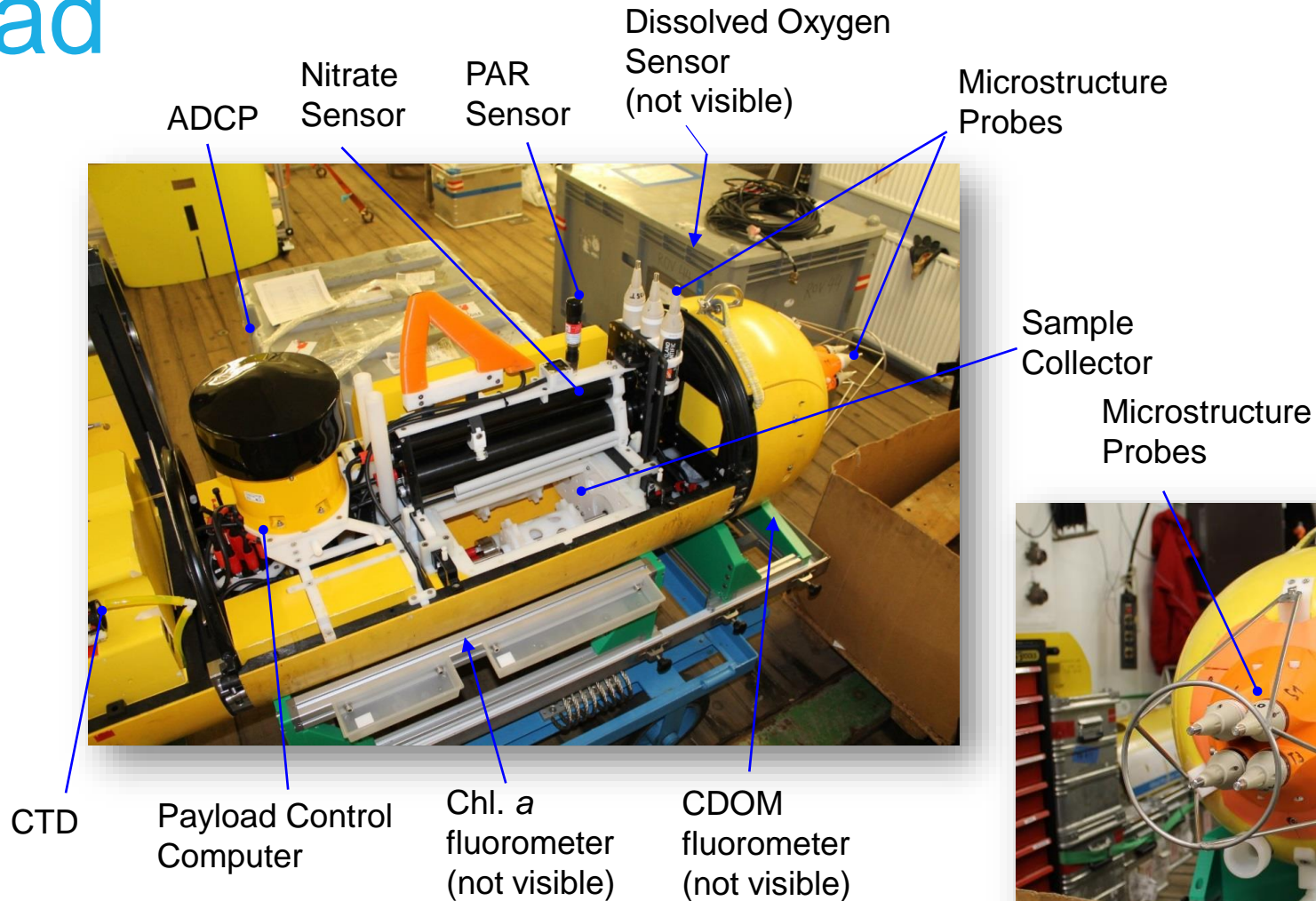

Introduction

- Team
- History
- Payload
- Pelagic

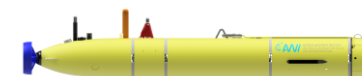

Payload

- Pelagic
 - Under ice

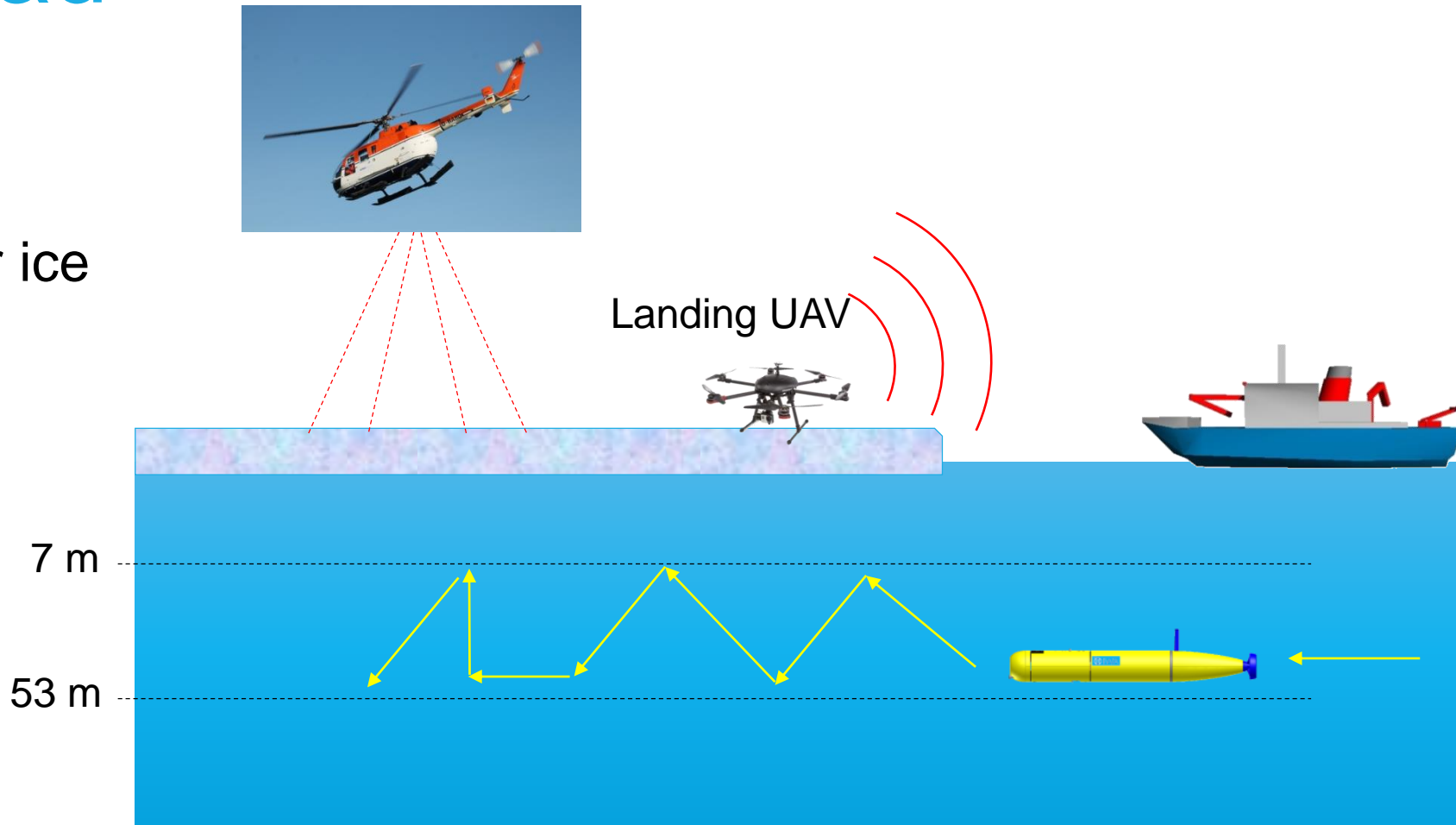

Introduction

- Team
- History
- Payload
 - Pelagic

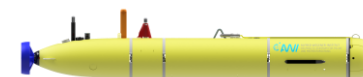

Payload

- Pelagic
 - Under ice



Introduction

- Team
- History
- Payload
- Pelagic



Payload

- Pelagic
 - Under ice



Foto: Jonas Hagemann

Foto: Sandra Tippenhauer



Introduction

- Team
 - History
- ## Payload
- Pelagic



Payload

- Pelagic
 - Under ice

Introduction

- Team
- History
- Payload
- Pelagic

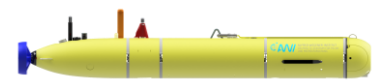
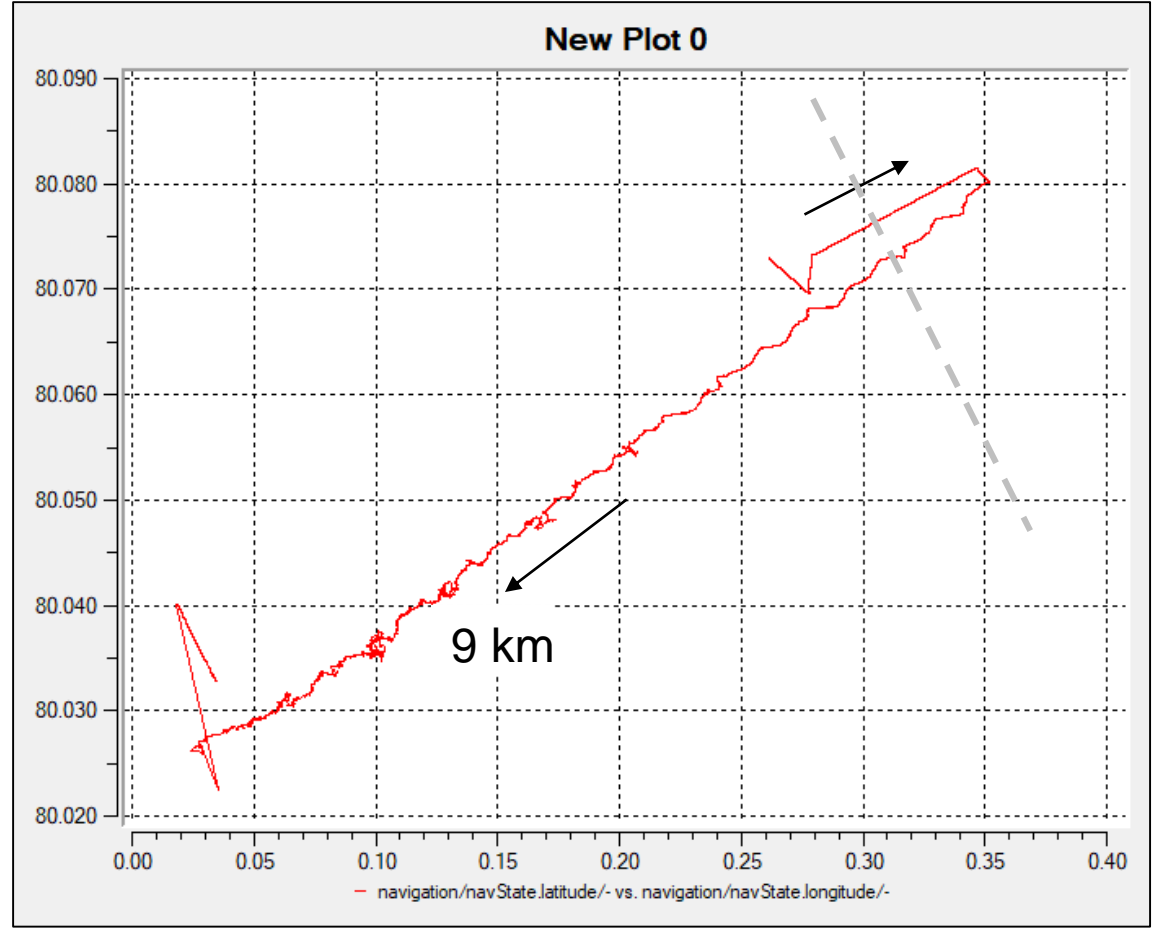
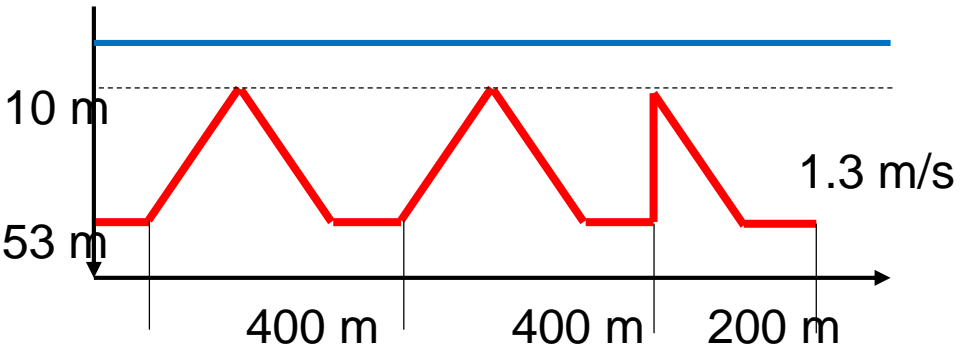

Payload

- Pelagic
 - Under ice

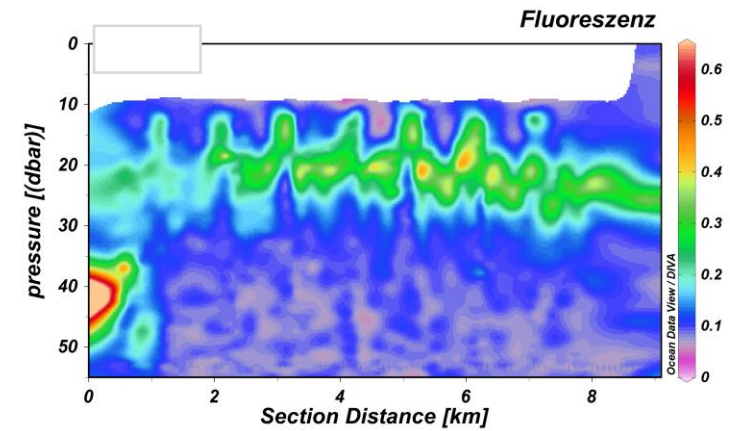
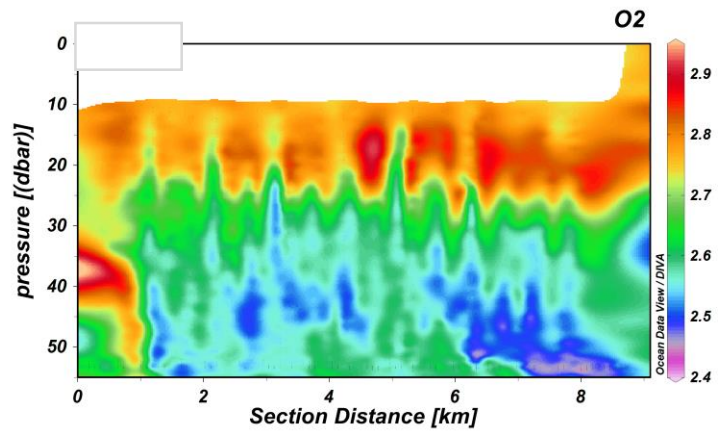
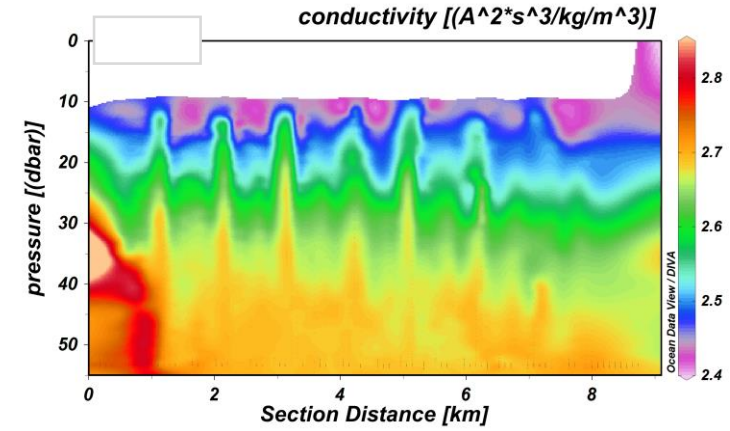
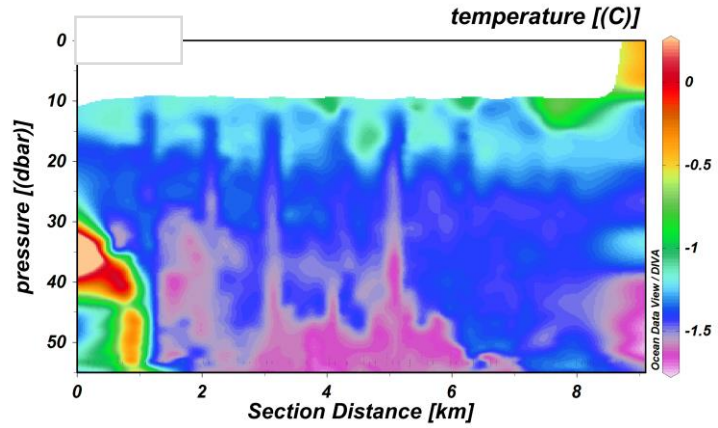

Introduction

- Team
- History
- Payload
 - Pelagic

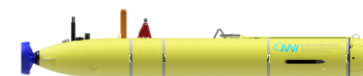

Payload

- Pelagic
 - Under ice
 - Ocean fronts

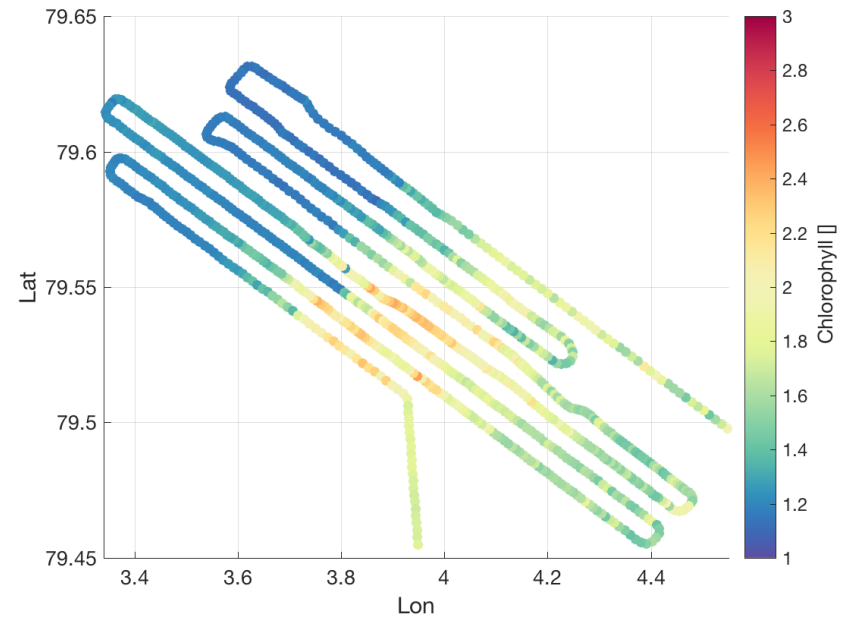
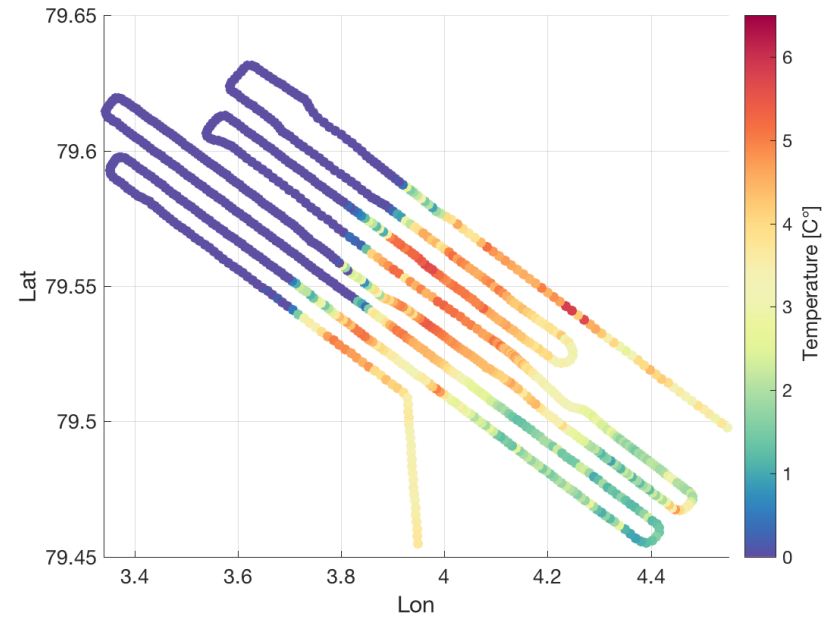

Introduction

- Team
- History
- Payload
- Pelagic

FRAM



20

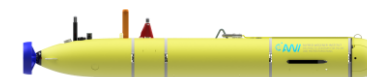

Payload

- Pelagic
 - Under ice
 - Ocean fronts

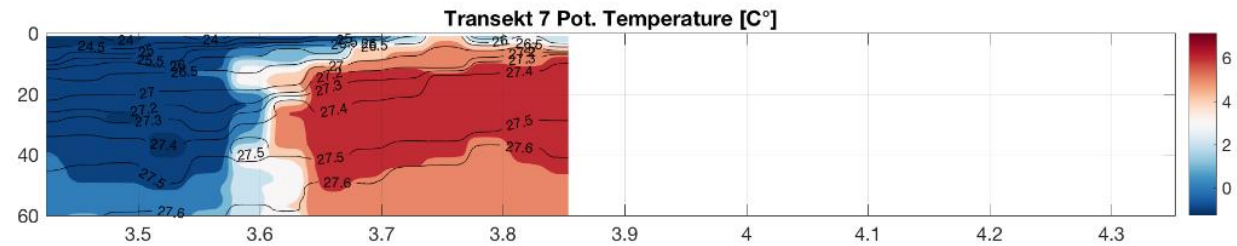
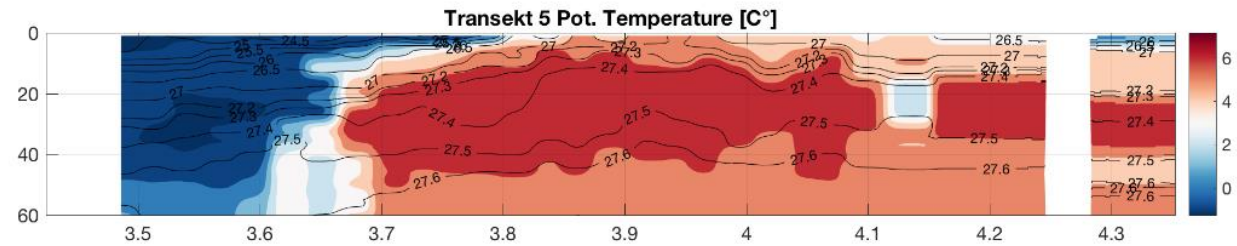
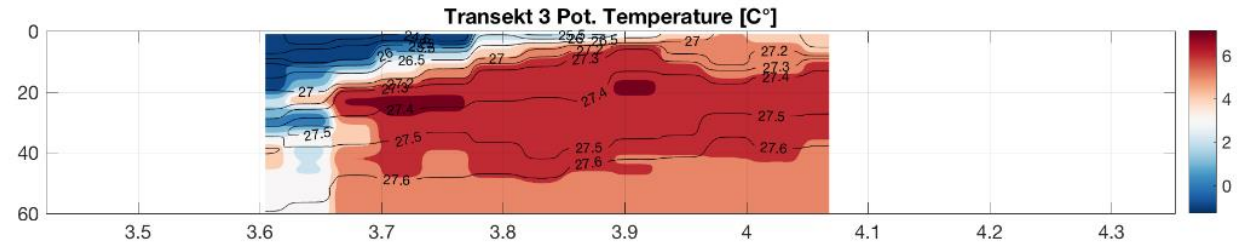
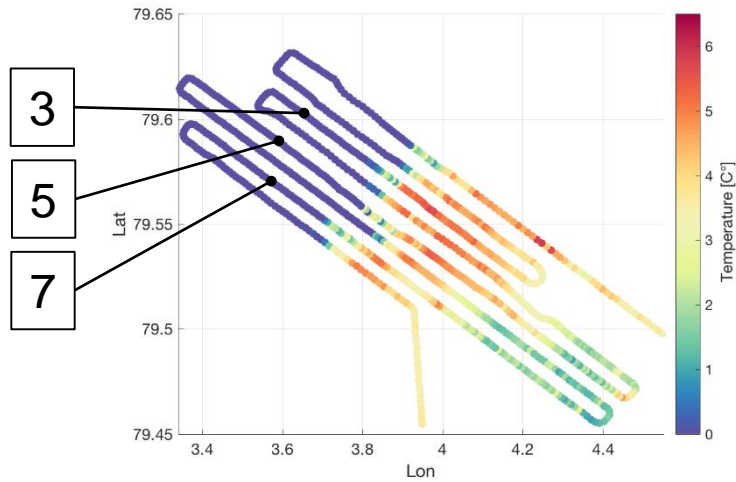

Introduction

- Team
- History
- Payload
- Pelagic

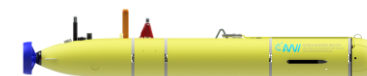

Payload

- Pelagic
 - Under ice
 - Ocean fronts

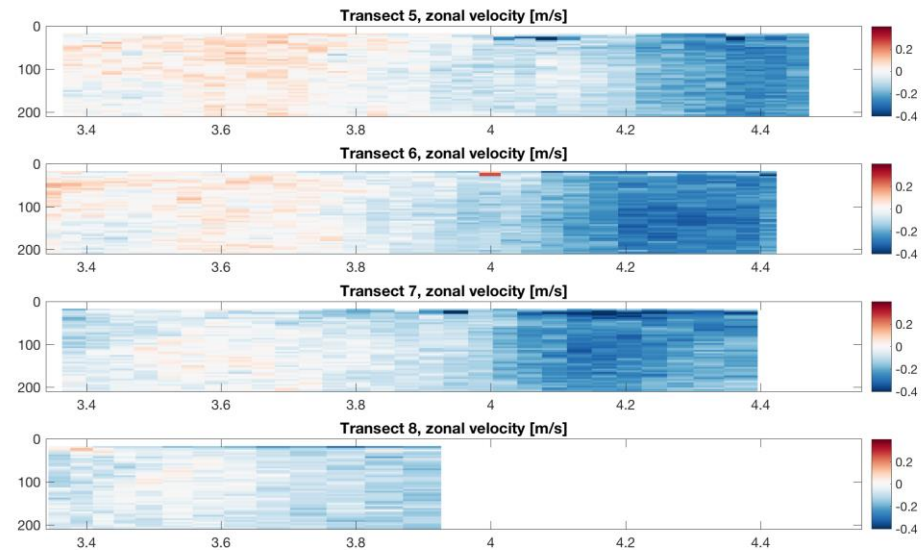
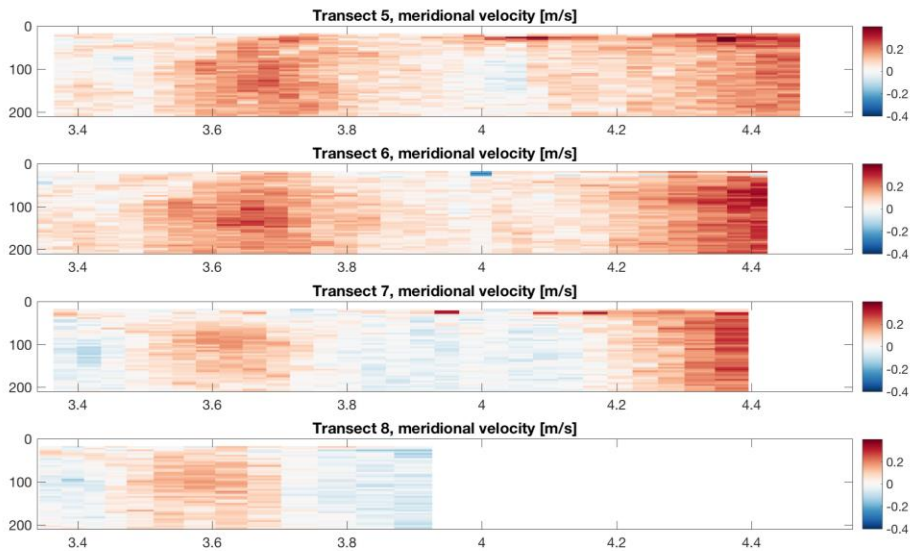
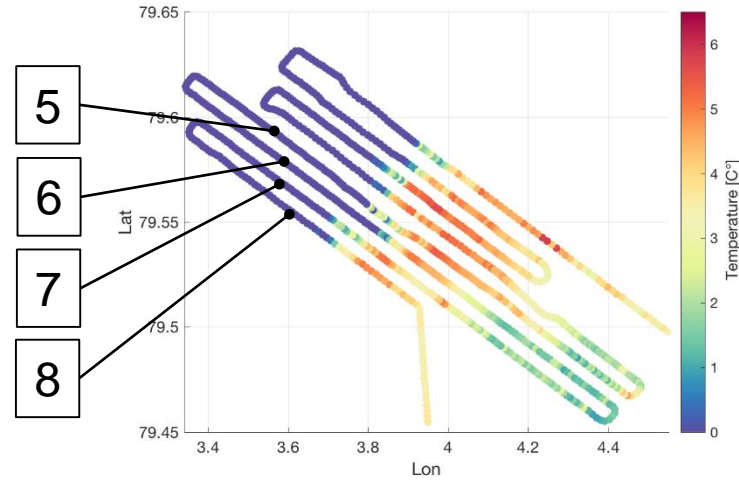

Introduction

- Team
- History
- Payload
- Pelagic

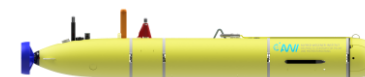

Payload

- Benthic

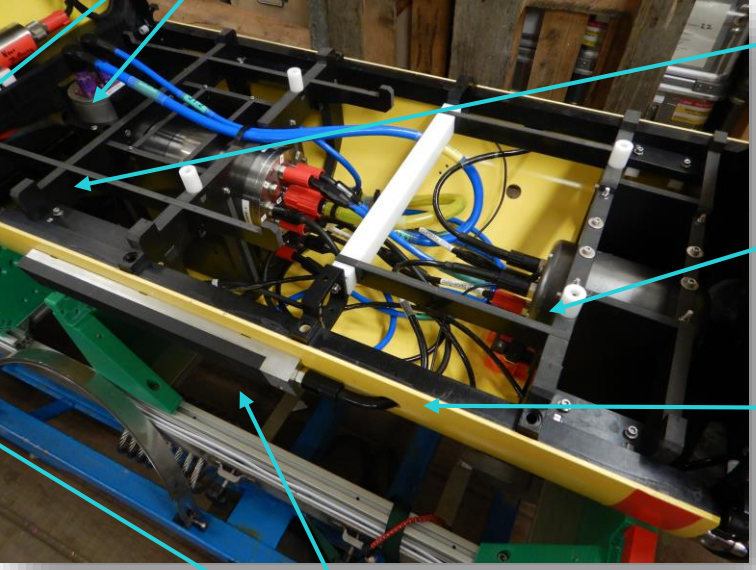
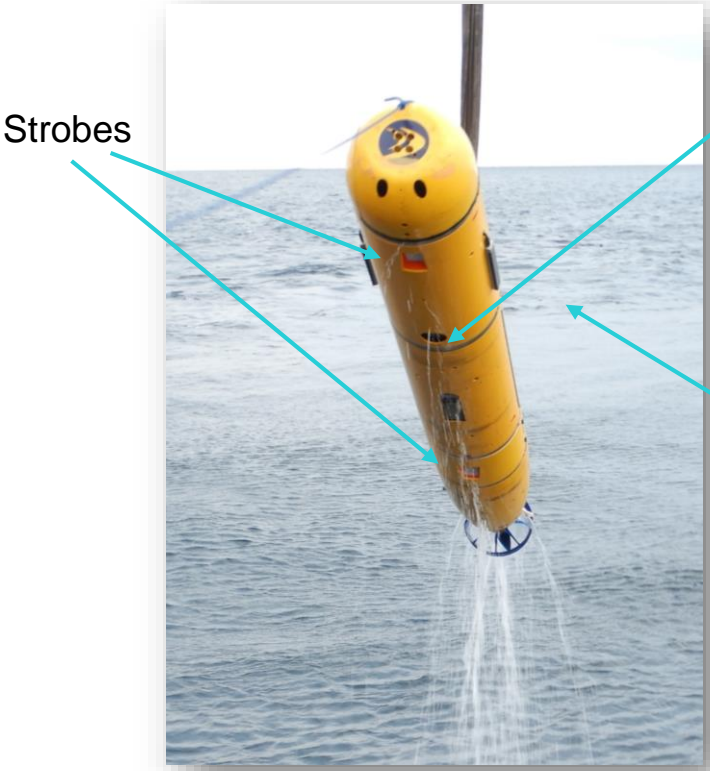

Sonar Transducer

Introduction

- Team
- History
- Payload
 - Pelagic
 - Benthic



Payload

- Benthic
 - Sidescan sonar
 - 600 / 1200 kHz
 - Range 60 m / 30 m

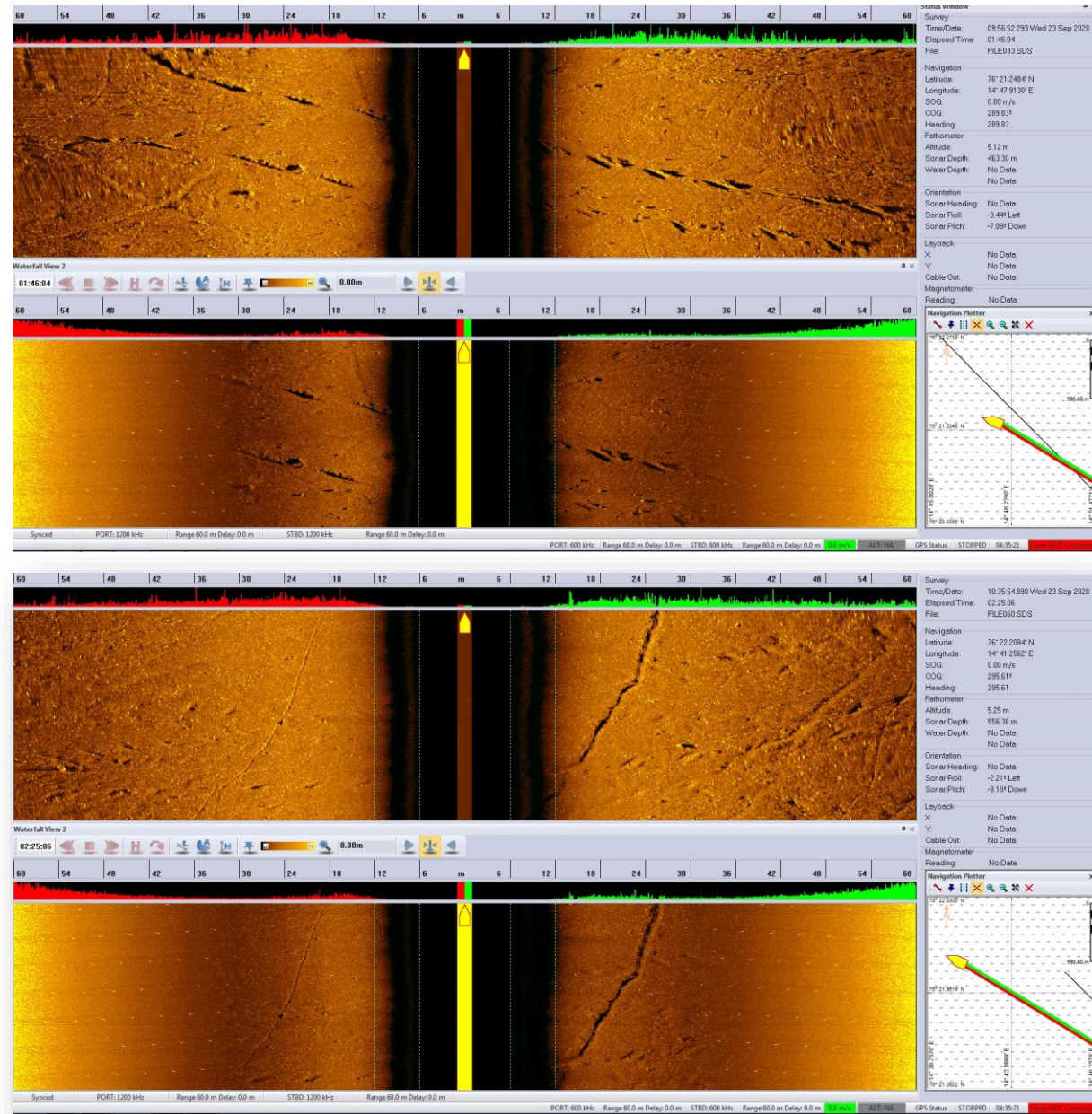

Introduction

- Team
- History
- Payload
- Pelagic
- Benthic



Payload

- Benthic
 - Sidescan sonar
 - 1200 kHz
 - Altitude 6 m
 - 9 parallel transects

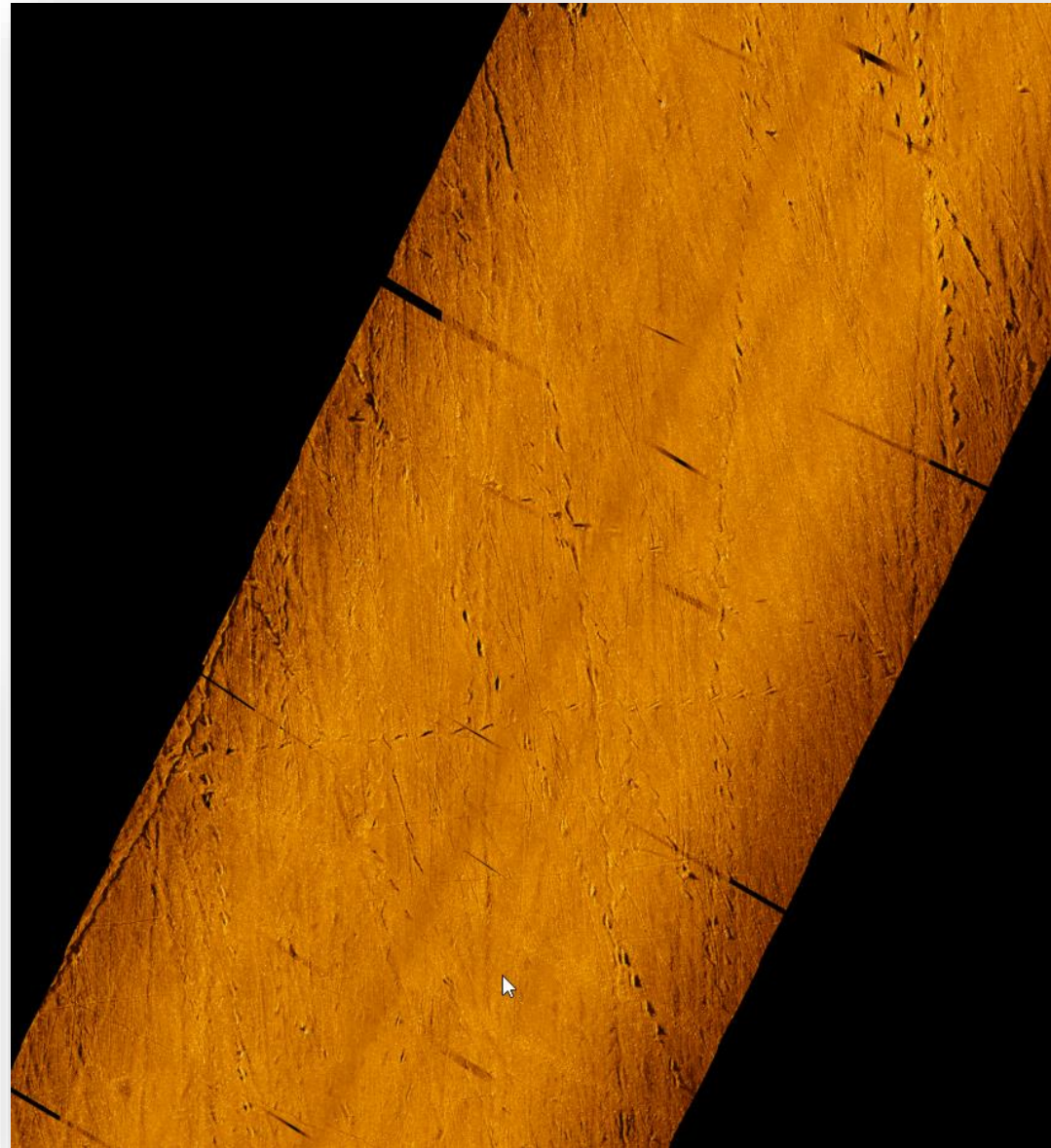
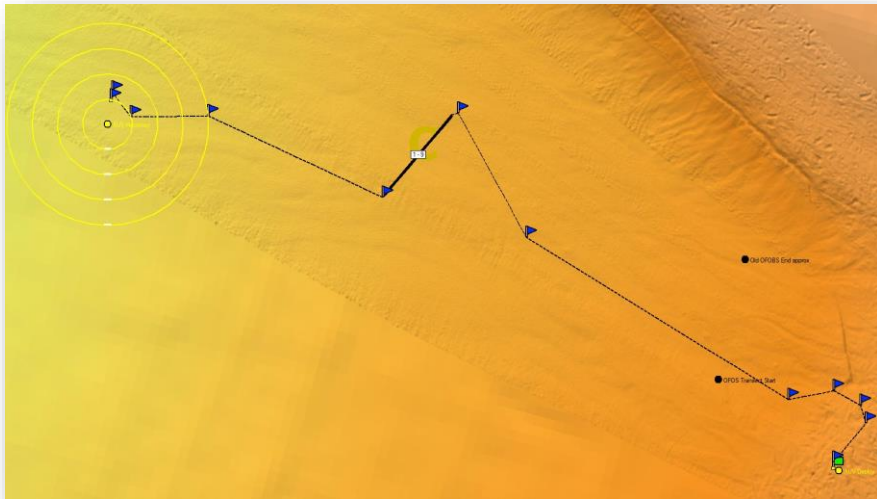

Introduction

- Team
- History
- Payload
 - Pelagic
 - Benthic



Payload

- Benthic

- Camera system

- Stills camera (7fps, 12,5MP)
 - 2 Strobes (150.000 lumes)

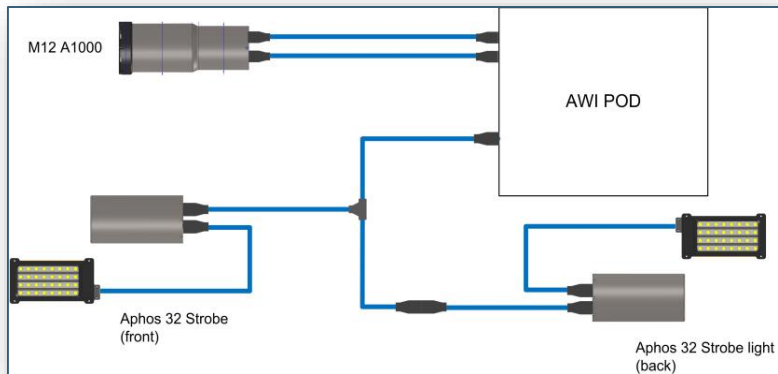

4.5 m

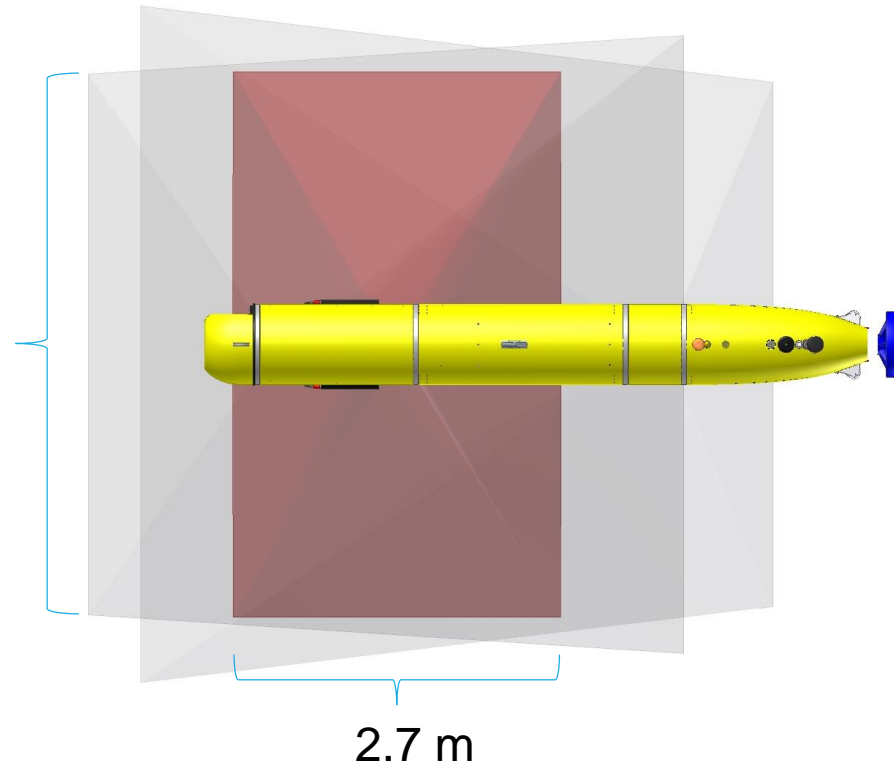

Image Area: 12.15 m² || Pixel Resolution (mm/pixel): 1.1

Introduction

- Team
- History

Payload

- Pelagic
- Benthic

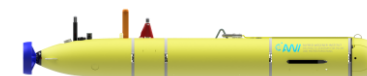

Payload

- Benthic
 - Camera system
 - Strobe section

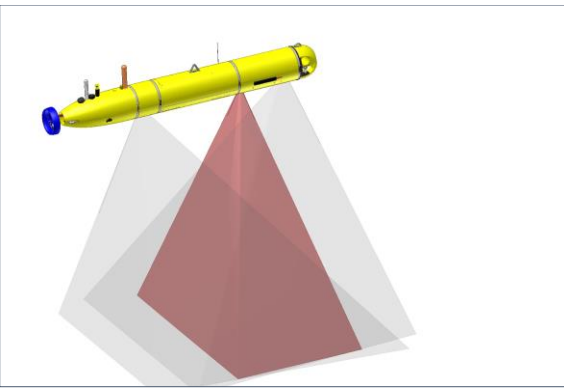

Introduction

- Team
- History

Payload

- Pelagic
- Benthic

Payload

- Benthic
 - Camera system
 - Altitude 5 m
 - Speed 1.5 m

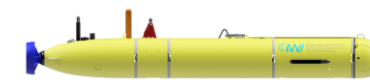
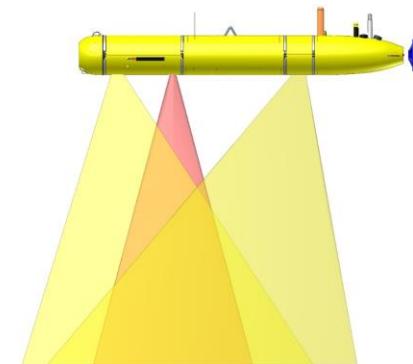
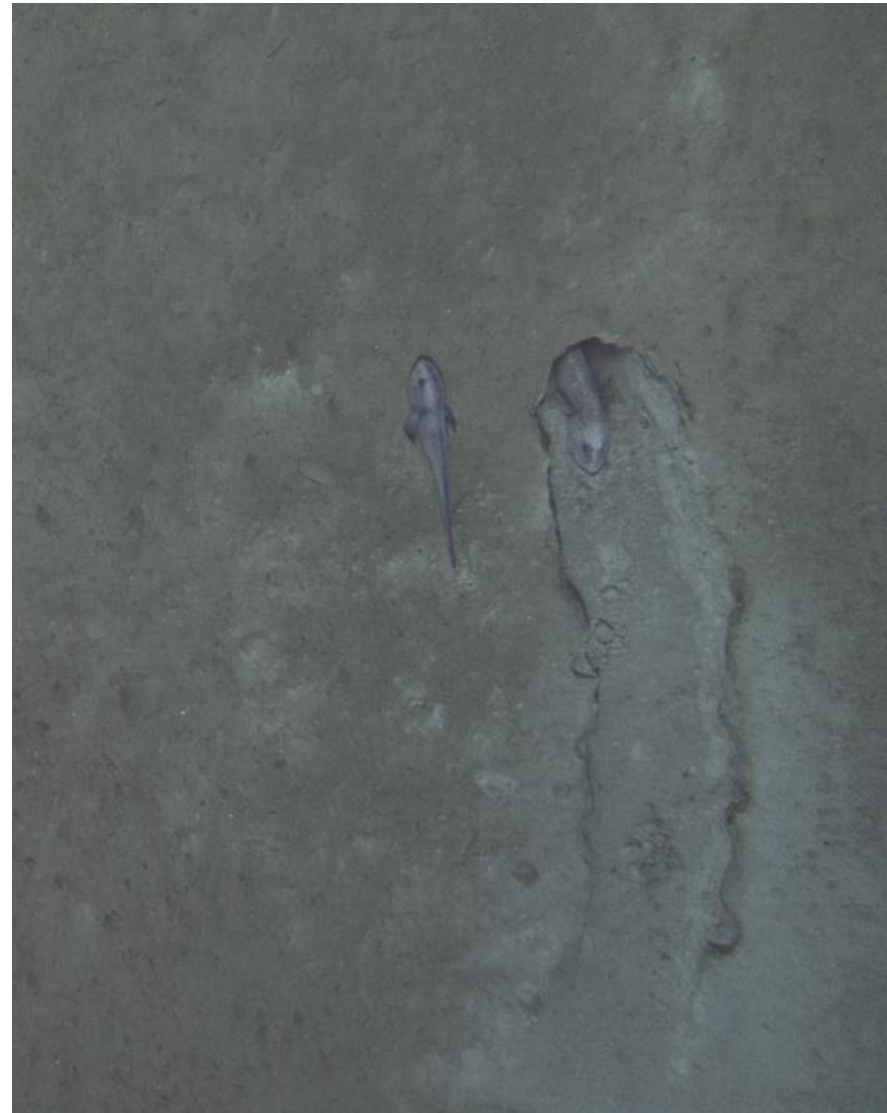

- Team
- History

Payload

- Pelagic
- Benthic

Payload

- Benthic
 - Camera system
 - Photomosaic

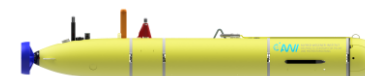
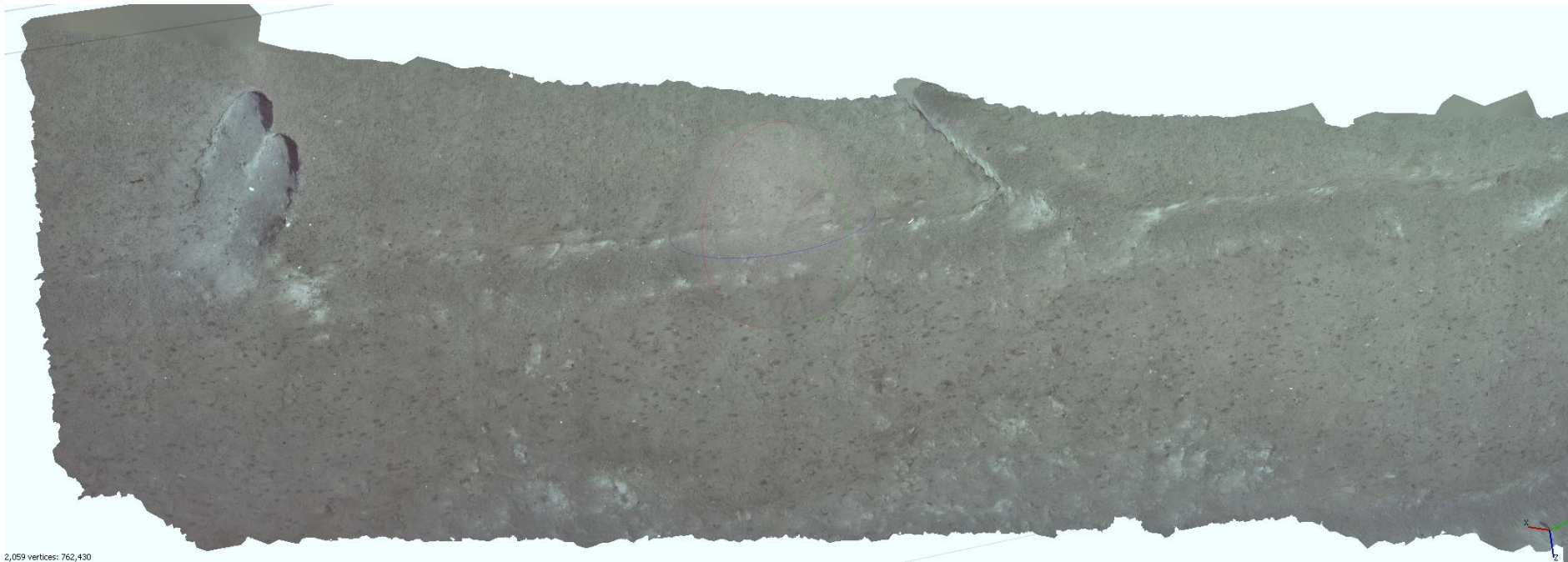

- Team
- History

Payload

- Pelagic
- Benthic

Payload

- Benthic
 - Camera system
 - Photomosaic

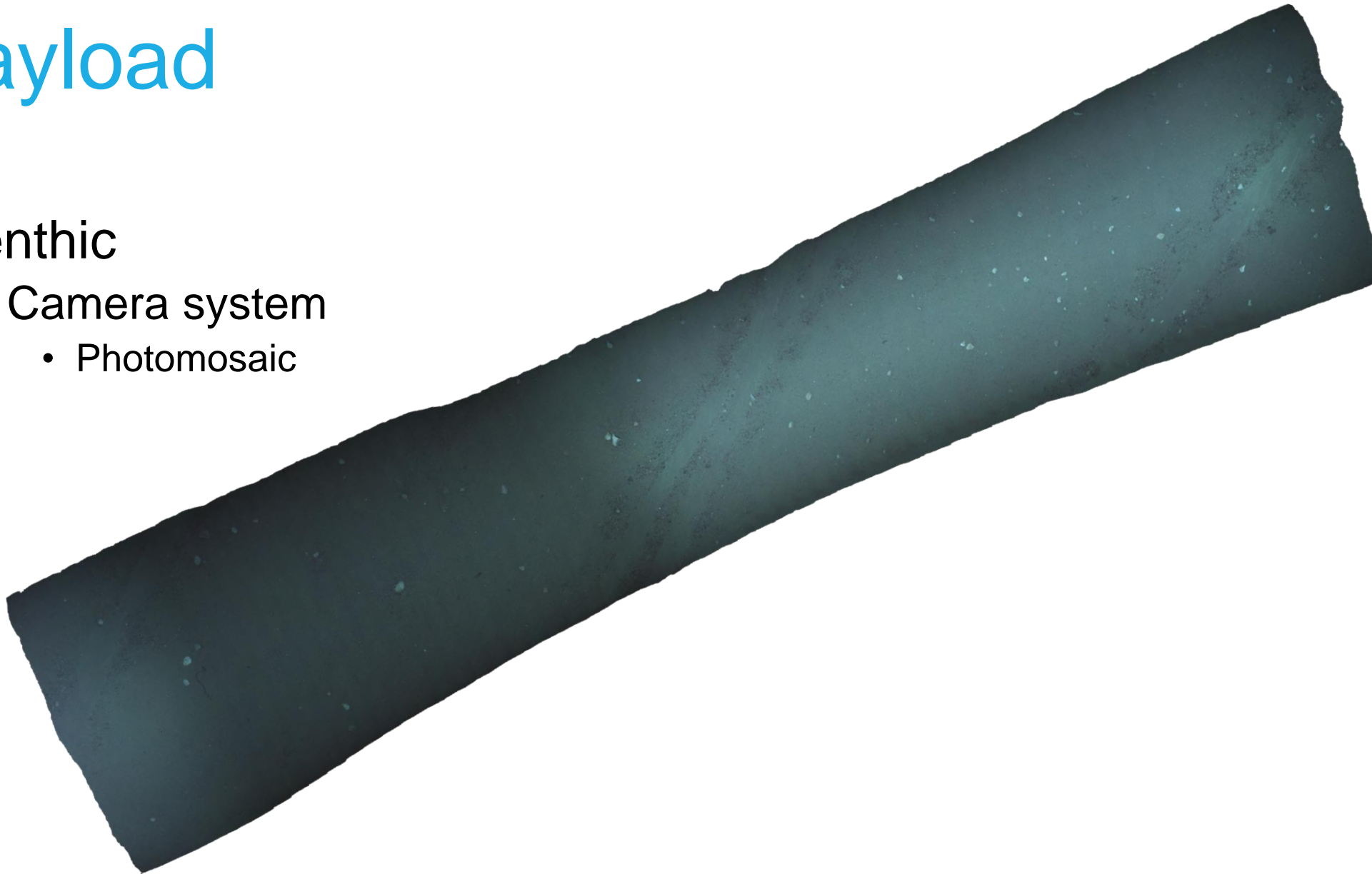

FRAM



30

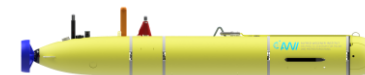

Introduction

- Team
- History

Payload

- Pelagic
- Benthic

Infrastructure

- Logistics
 - 20" Container
 - Transportation
 - Controlroom
 - Workshop
 - Store

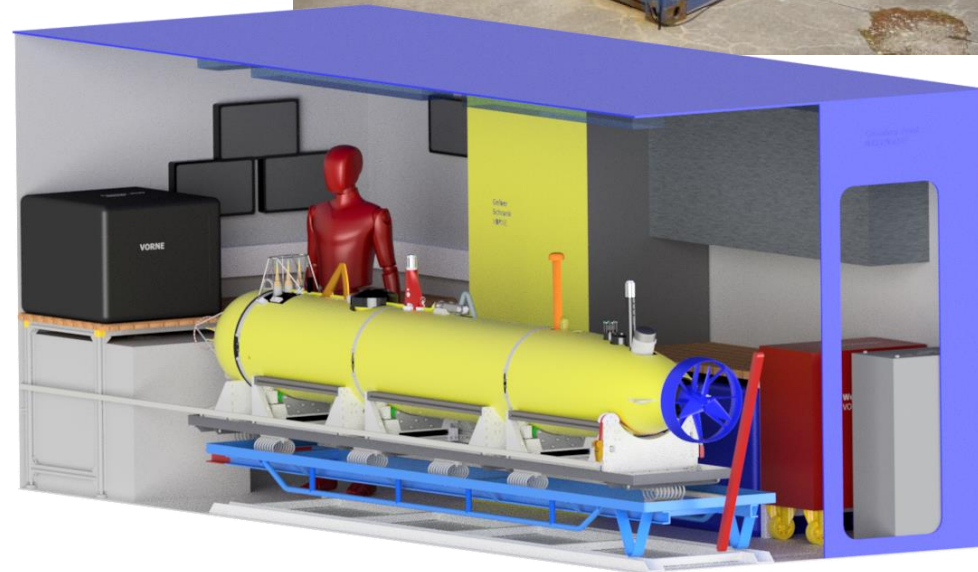

Introduction

- Team
- History

Payload

- Pelagic
- Benthic

Infrastructure

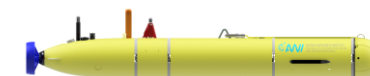

Infrastructure

- Logistics
 - Trolley
 - Vibration compensation
 - Section separation



Introduction

- Team
- History

Payload

- Pelagic
- Benthic

Infrastructure

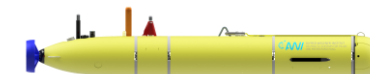

Infrastructure

- Logistics
 - Trailer
 - A-Frame
 - Tests in local lakes



Introduction

- Team
- History

Payload

- Pelagic
- Benthic

Infrastructure



Infrastructure

- Accessories
 - Ballasting basin



Introduction

- Team
- History

Payload

- Pelagic
- Benthic

Infrastructure

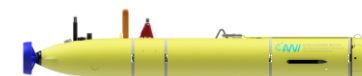

Infrastructure

- Accessories
 - Pressure tank



Introduction

- Team
- History

Payload

- Pelagic
- Benthic

Infrastructure



Infrastructure

- Accessories
 - Zodiac



Introduction

- Team
- History

Payload

- Pelagic
- Benthic

Infrastructure

FRAM



36



Operator Suite

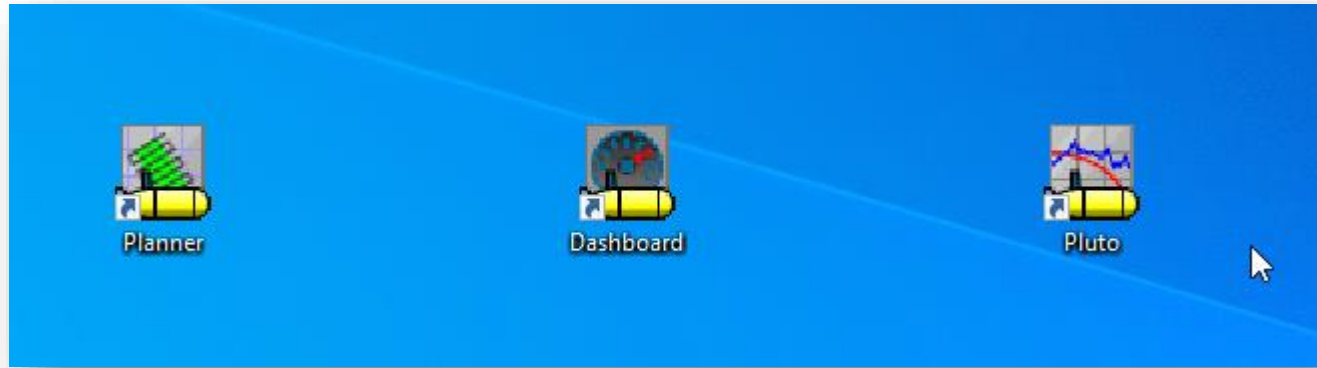

Introduction

- Team
- History

Payload

- Pelagic
- Benthic

Infrastructure

Operator Suite

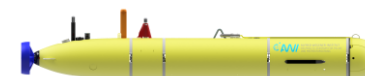

Operator Suite

- Mission Planner

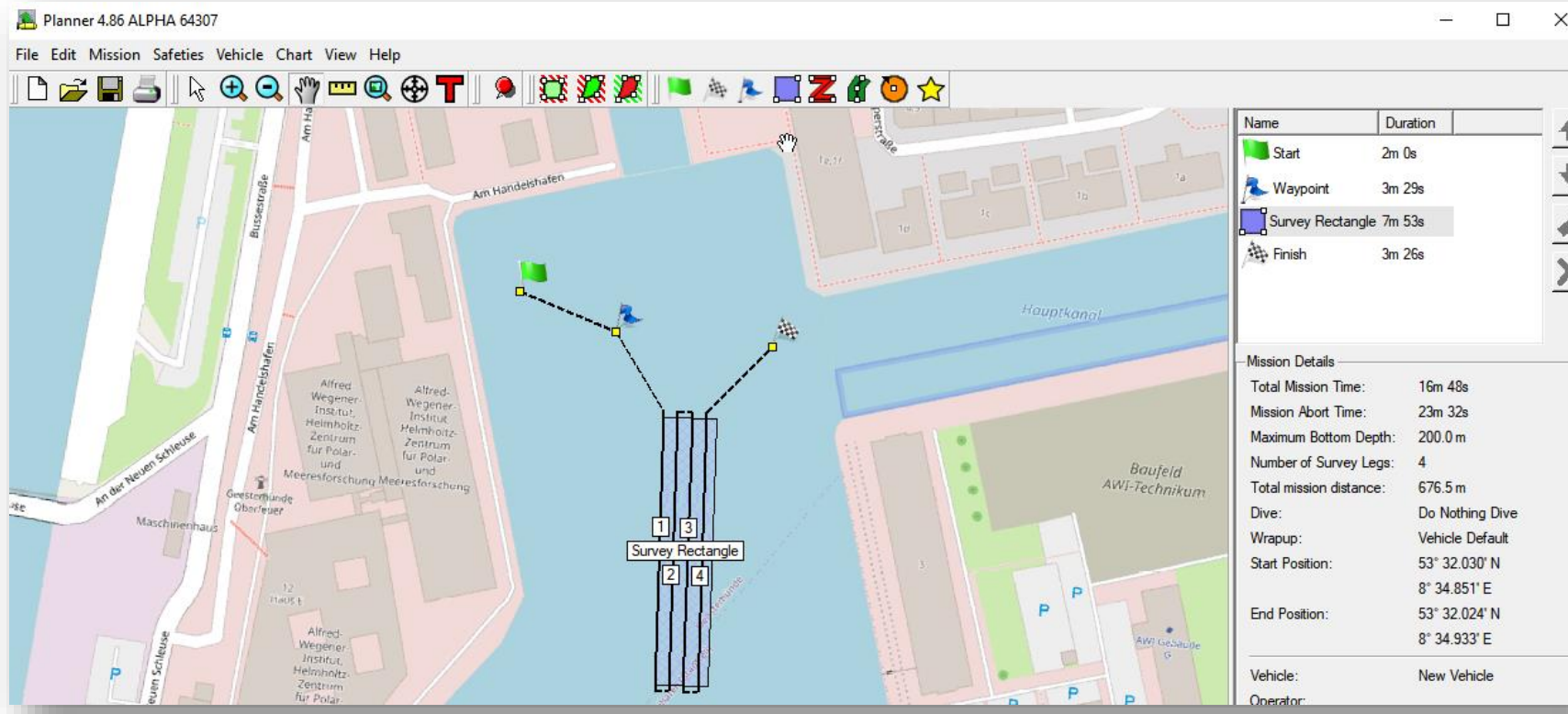

Introduction

- Team
- History

Payload

- Pelagic
- Benthic

Infrastructure

Operator Suite

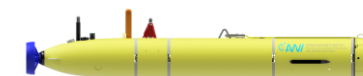

Operator Suite

- Dashboard

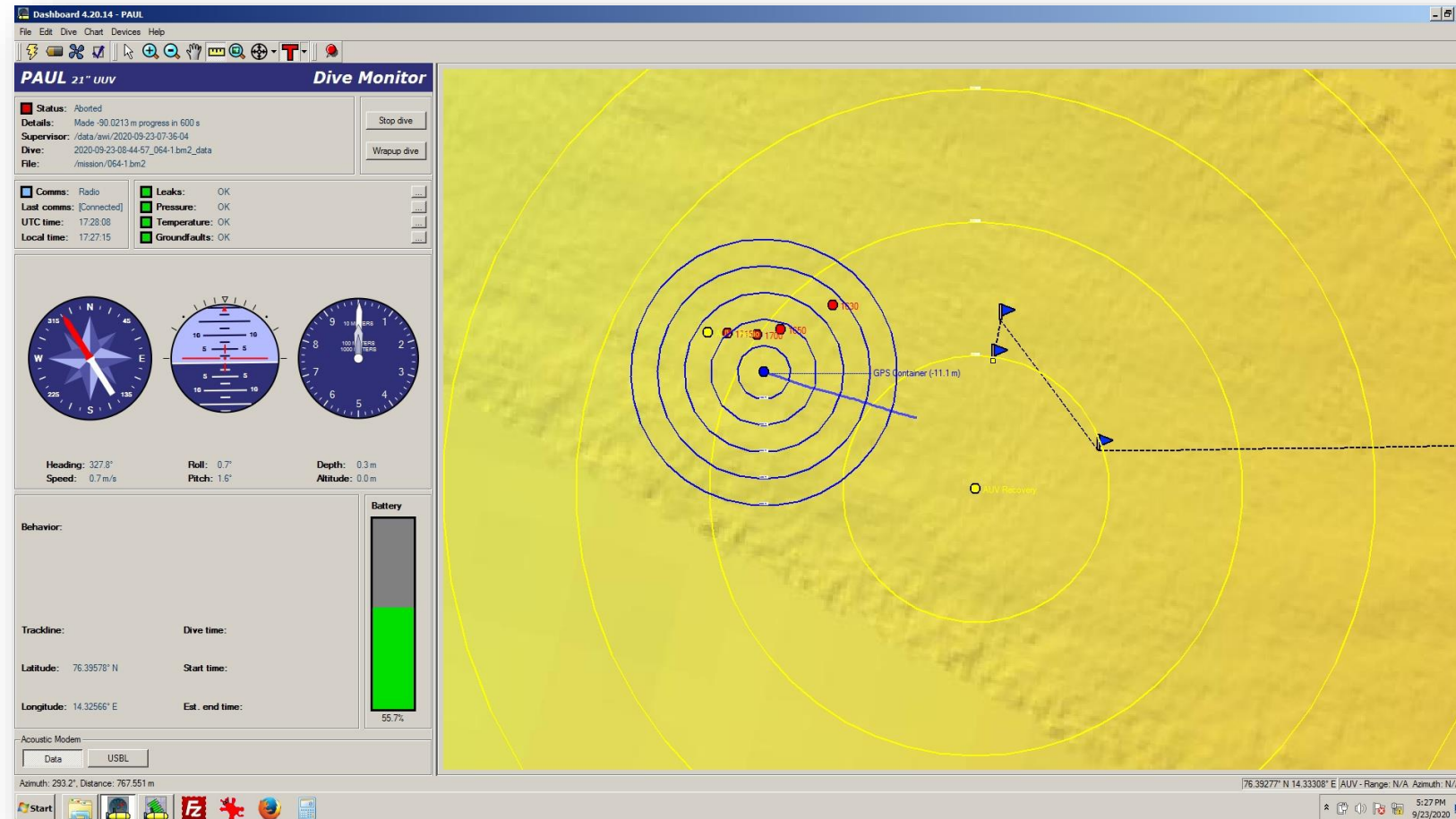

Introduction

- Team
- History

Payload

- Pelagic
- Benthic

Infrastructure

Operator Suite

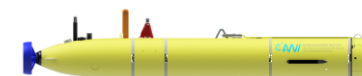

Operator Suite

- Dashboard

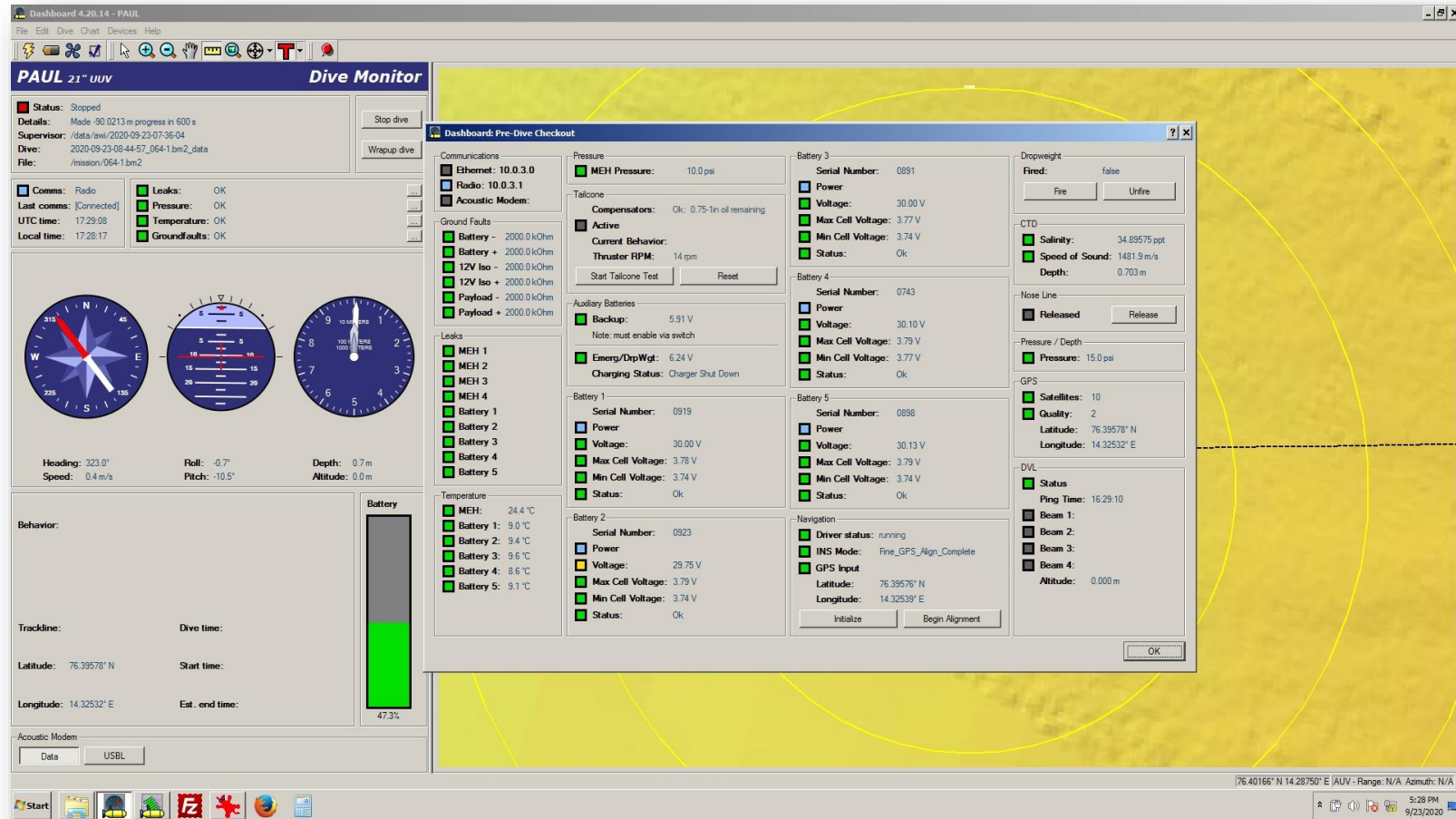

Introduction

- Team
- History
- Payload
- Pelagic
- Benthic
- Infrastructure
- Operator Suite

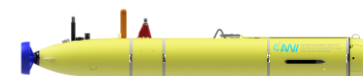

Operator Suite

- Pluto

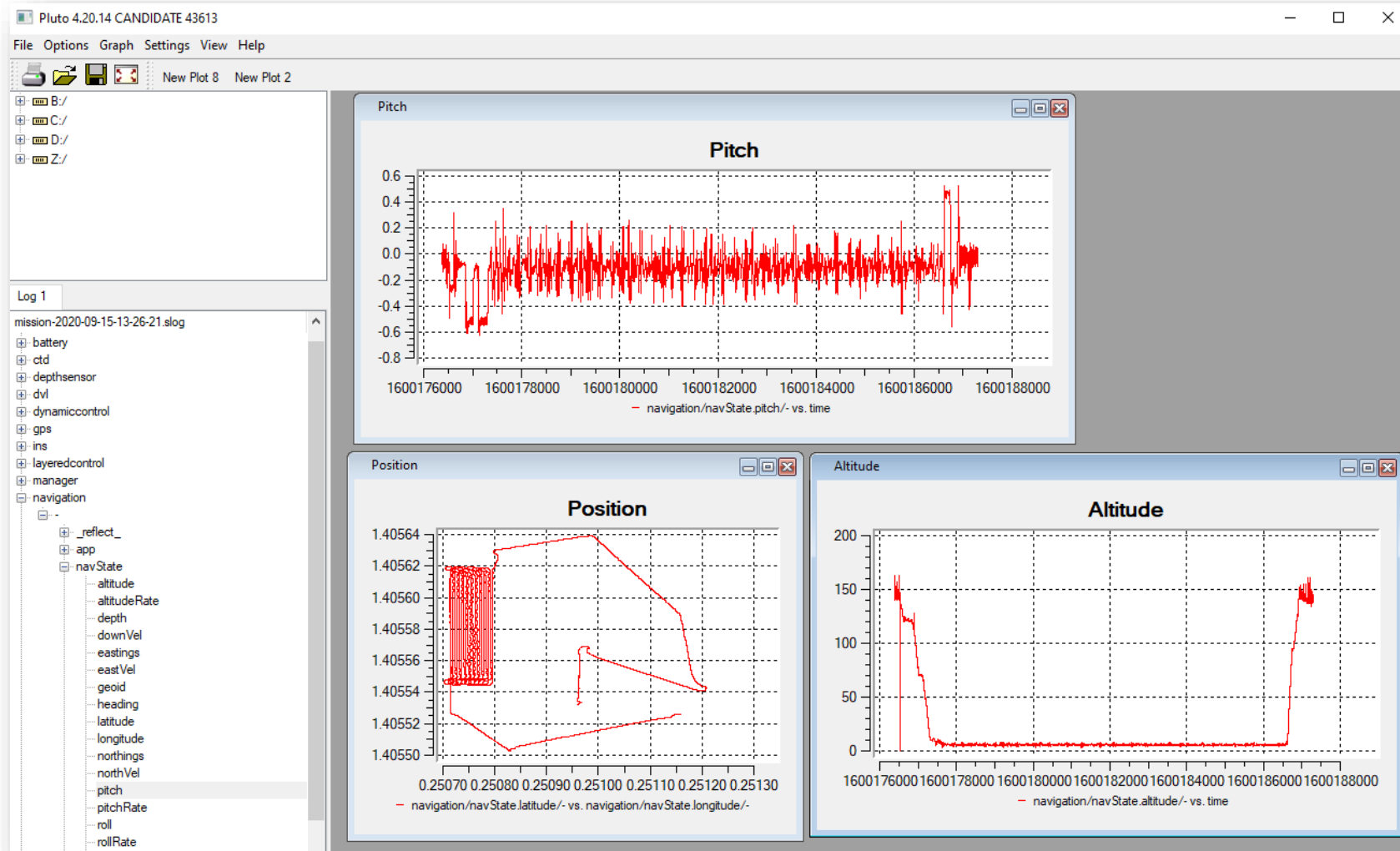

Introduction

- Team
- History

Payload

- Pelagic
- Benthic

Infrastructure

Operator Suite



Development

- Mechanical
 - Sensor implementation

Camera

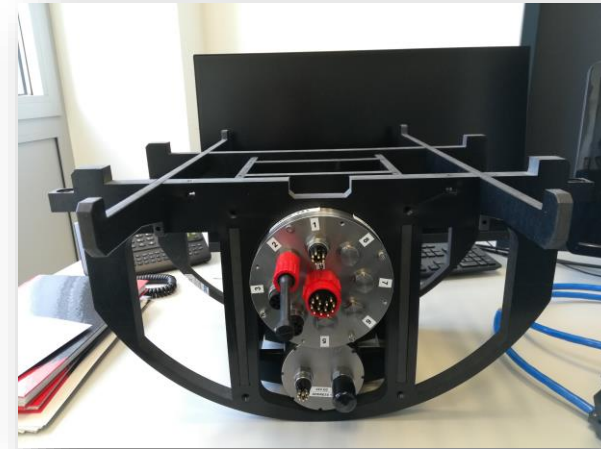
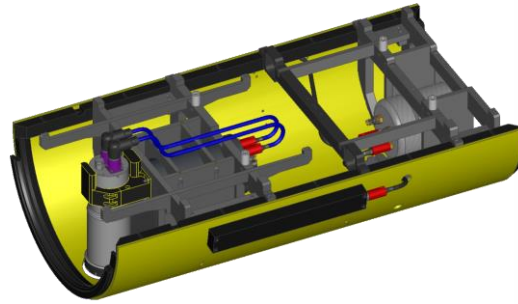

Acoustic Modem

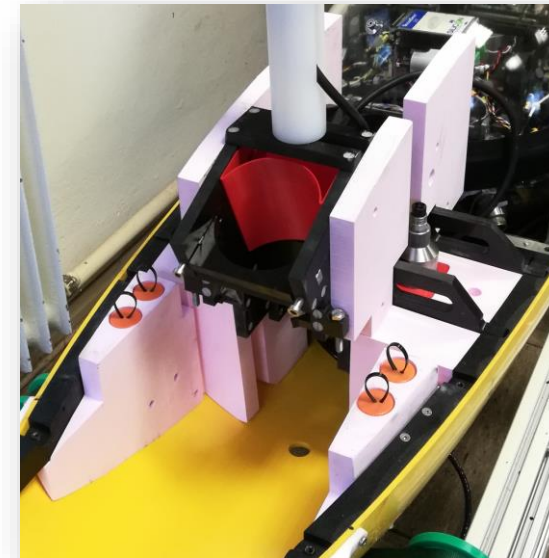
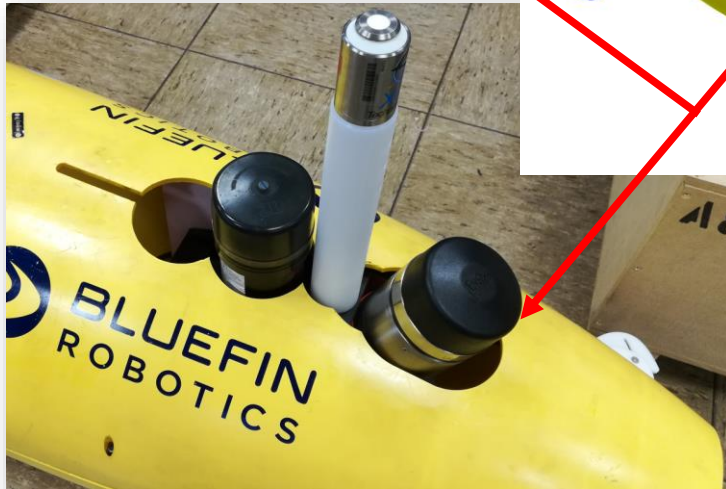
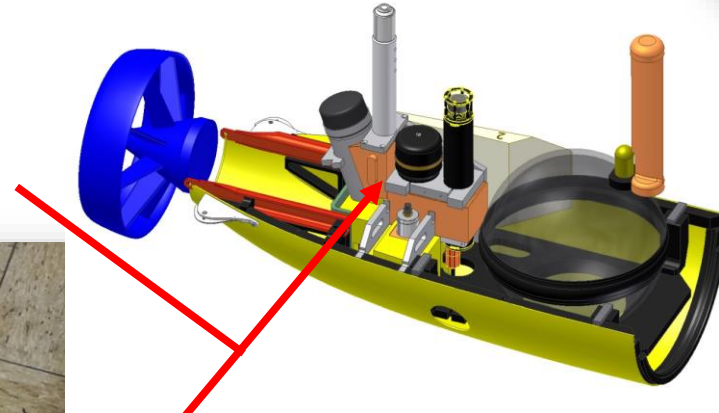

Introduction

- Team
- History

Payload

- Pelagic
- Benthic

Infrastructure

Operator Suite

Development

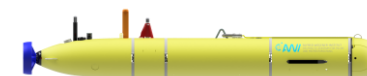

Development

- Mechanical
 - Additional section

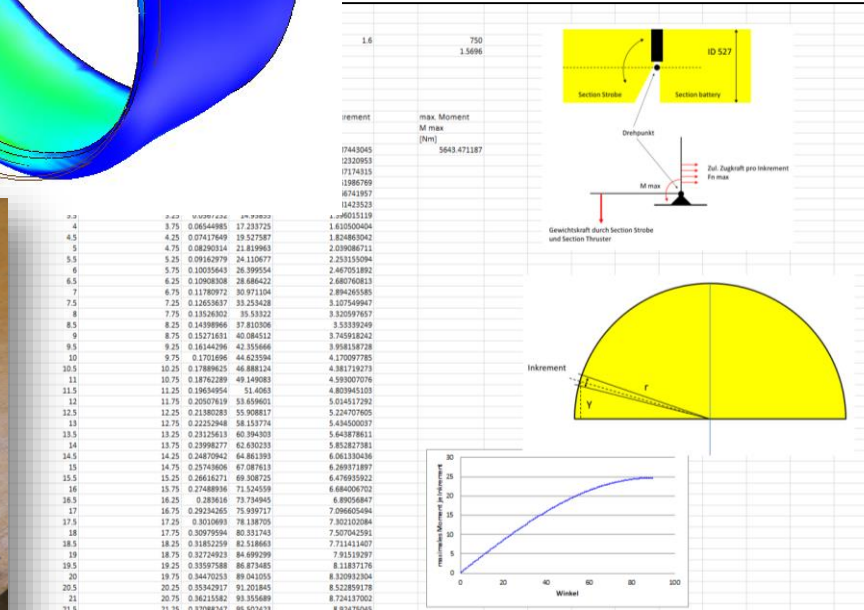
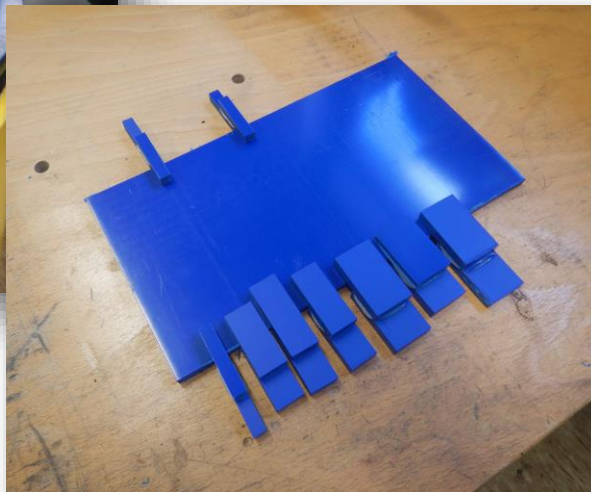
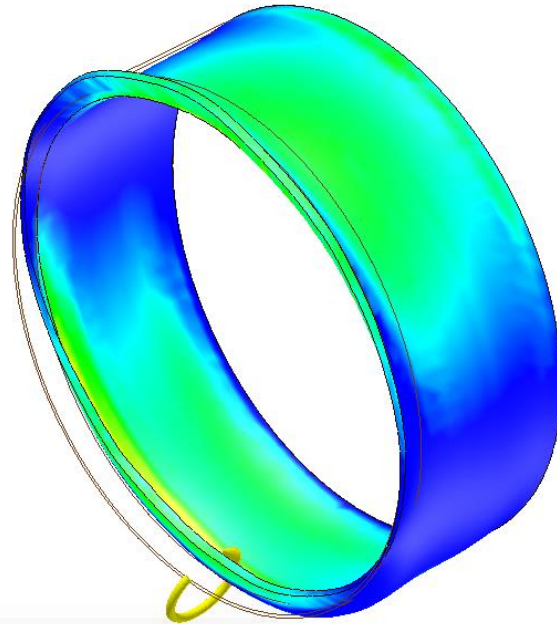

Introduction

- Team
- History

Payload

- Pelagic
- Benthic

Infrastructure

Operator Suite

Development

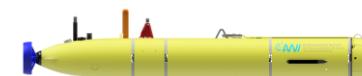

Development

- Electrical
 - Sensor implementation

- Team
- History

Payload

- Pelagic
- Benthic

Infrastructure
Operator Suite

Development

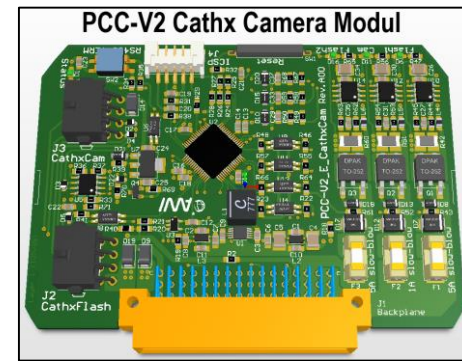
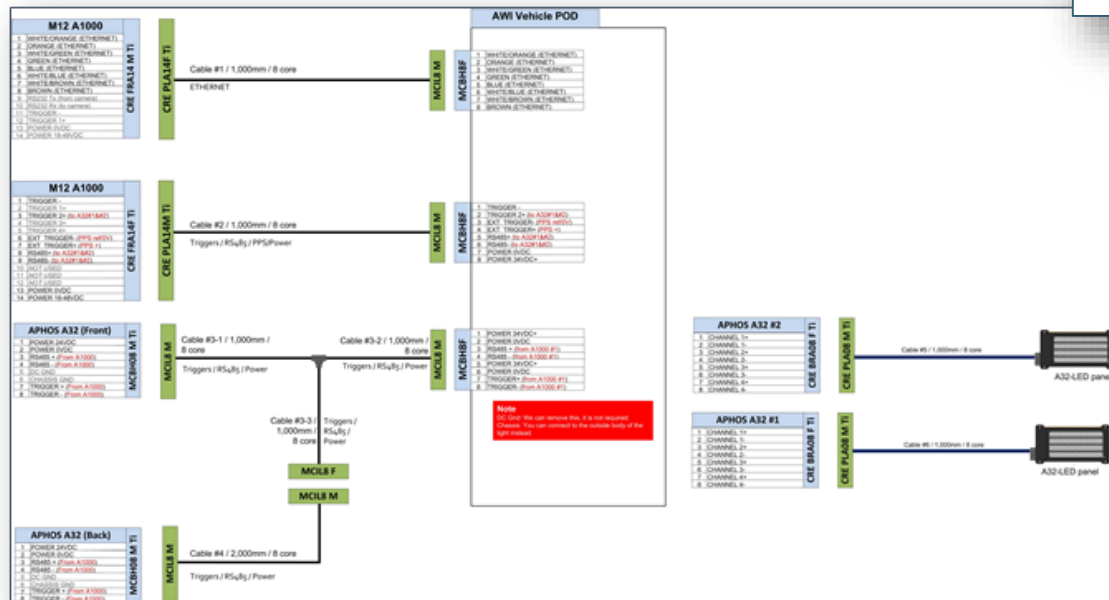
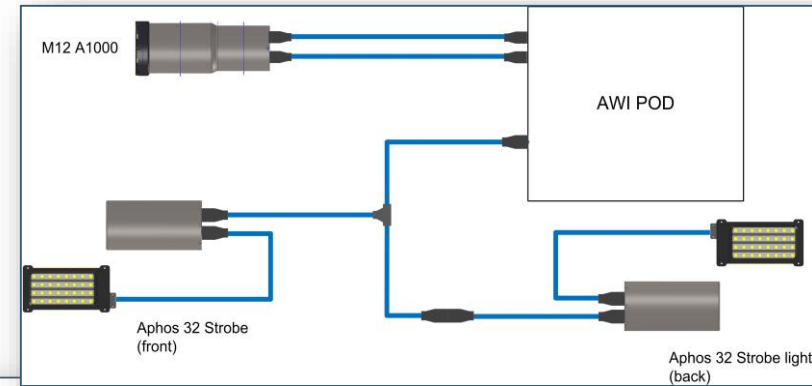

Development

- Electrical
 - Electronic design

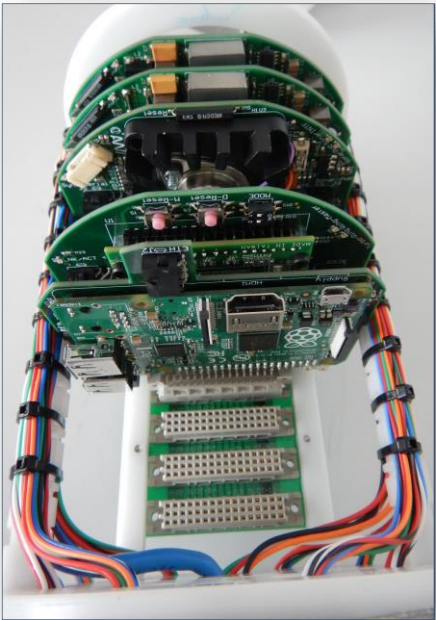
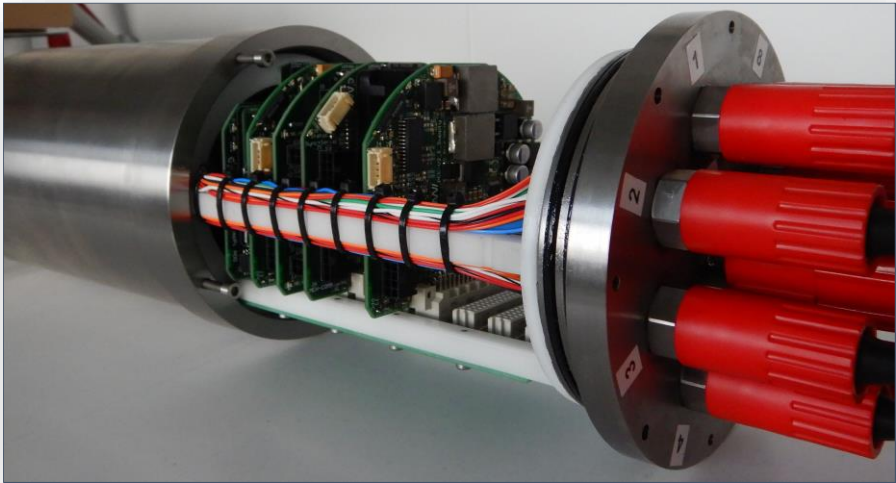
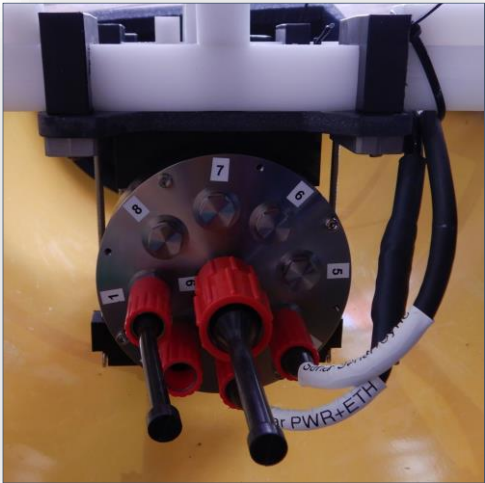

Introduction

- Team
- History

Payload

- Pelagic
- Benthic

Infrastructure

Operator Suite

Development

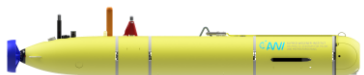

Operation

- Communication

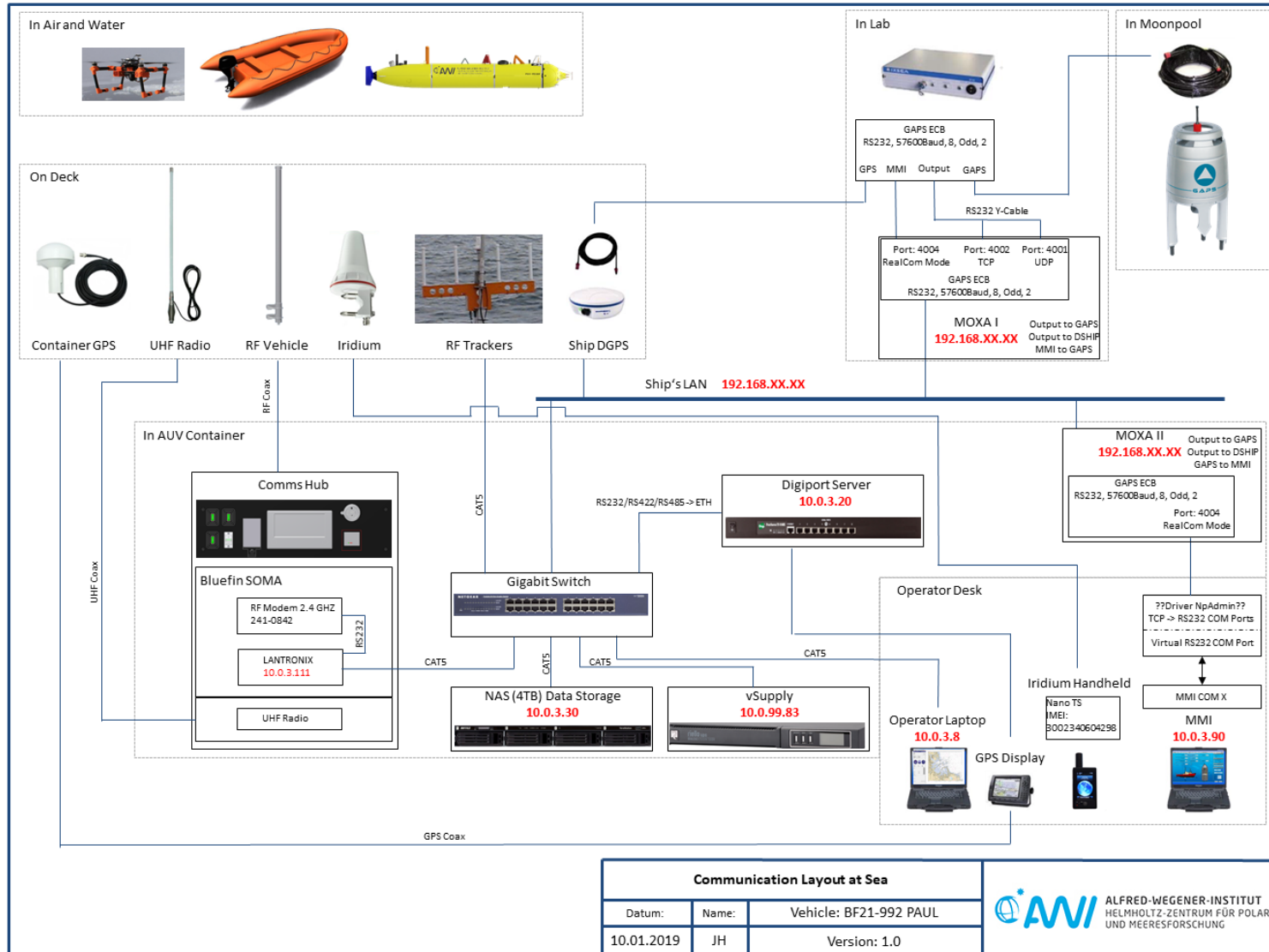

Introduction

- Team
- History
- Payload
- Pelagic
- Benthic

- Infrastructure
- Operator Suite
- Development
- Operation

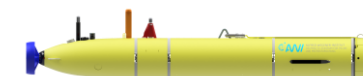

Operation

- Pre-Dive



Introduction

- Team
- History

Payload

- Pelagic
- Benthic

Infrastructure

Operator Suite

Development

Operation

FRAM



47

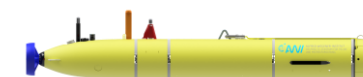

Operation

- Launch



Introduction

- Team
- History

Payload

- Pelagic
- Benthic

Infrastructure

Operator Suite

Development

Operation

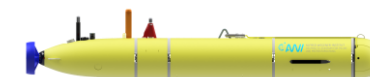

Operation

- Dive



Introduction

- Team
- History

Payload

- Pelagic
- Benthic

Infrastructure

Operator Suite

Development

Operation

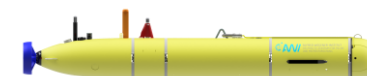

Operation

- Recovery

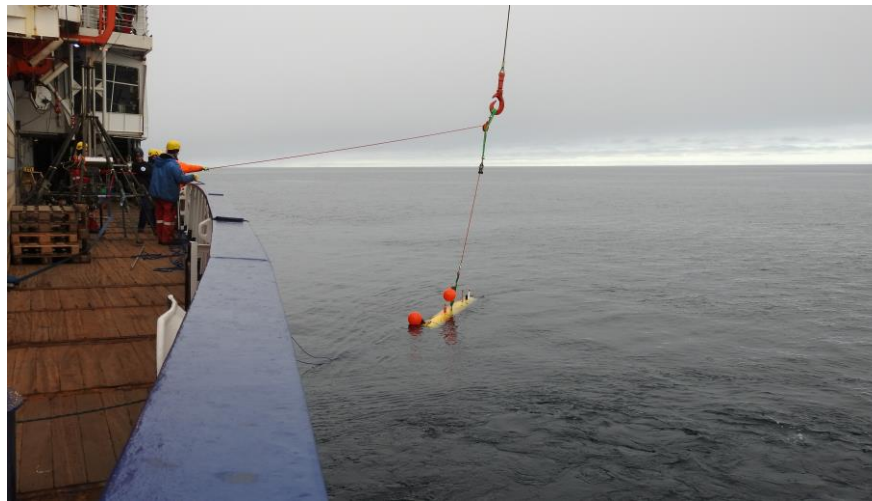
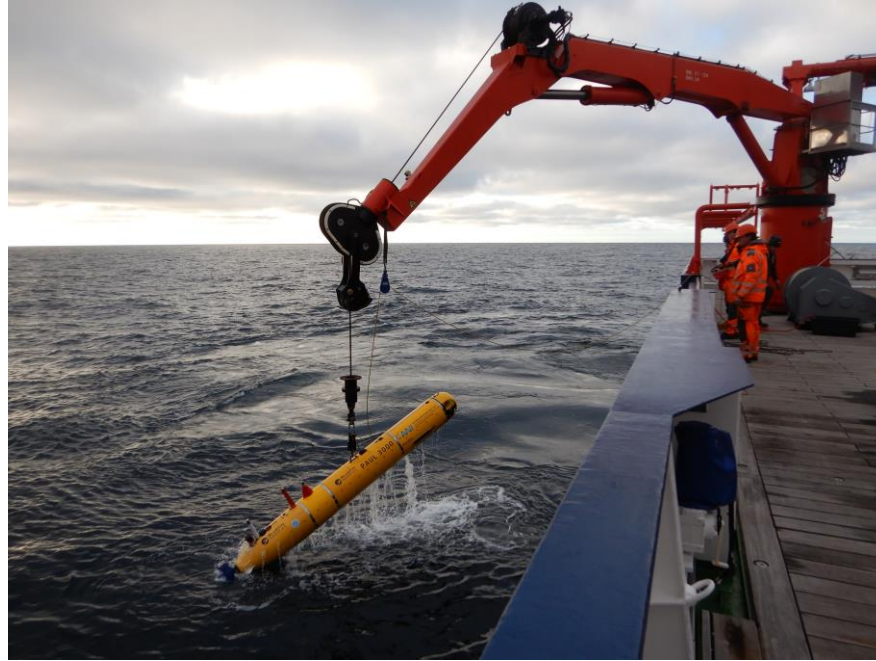

Introduction

- Team
- History

Payload

- Pelagic
- Benthic

Infrastructure

Operator Suite

Development

Operation

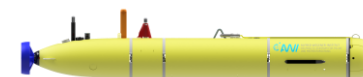

Operation

- Post-Dive



Introduction

- Team
- History

Payload

- Pelagic
- Benthic

Infrastructure

Operator Suite

Development

Operation

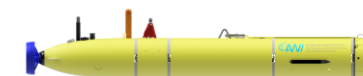

Operation

- Processing
 - Data correction

Water Depth: 1500 m

Time to descend: 31 min

Error: 110 m

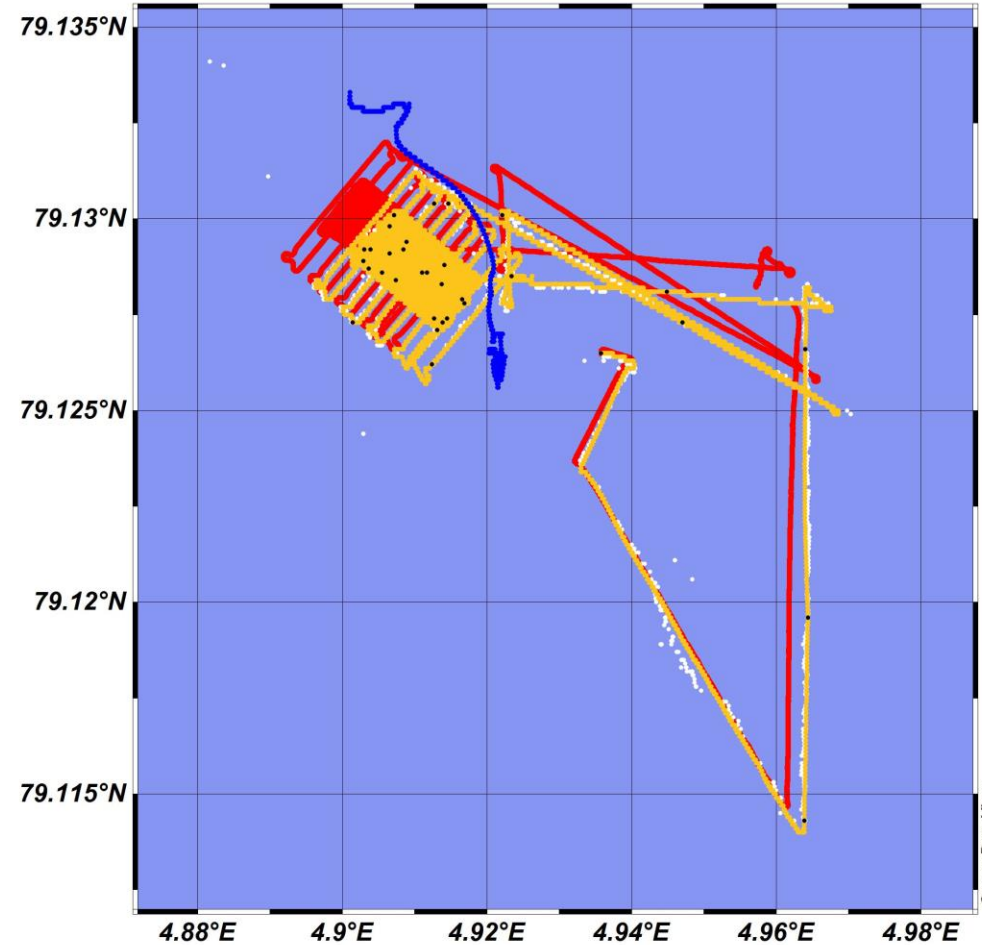

Introduction

- Team
- History

Payload

- Pelagic
- Benthic

Infrastructure

Operator Suite

Development

Operation

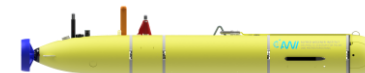

Q & A



Contact information:
Jonas.Hagemann@awi.de

Introduction

- Team
- History

Payload

- Pelagic
- Benthic

Infrastructure

Operator Suite

Development

Operation

Q & A

FRAM



53

