

# **Ecological restoration of European flat oysters in the German Bight**

**Dissertation**

in fulfilment of the requirements for the degree of Dr. rer. nat.

of the Faculty of Mathematics and Natural Sciences

at Kiel University

Submitted by

**Bérenger Colsoul**

Kiel 2022

First examiner: Prof. Dr. Karen Helen Wiltshire  
Second examiner: PD. Dr. Frank Melzner  
Date of oral examination: 15.12.2022







Dedicated to  
Rieke, Emil, Malo & Louane



# Bérenger Isidore Alain Colsoul

Contact details

Email: berenger.colsoul@awi.de

Phone: +49(0)151-6335-1428

ORCID: 0000-0002-7891-8036

WoS-ResearcherID: ABF-7497-2020

Scopus-AuthorID: 57219866885

Address: Kammerweg 13A, 27574 Bremerhaven (Germany)



# Table of contents

<b>List of abbreviations</b>	<b>11</b>
<b>Summary</b>	<b>13</b>
<b>Zusammenfassung</b>	<b>14</b>
<b>1 General introduction and objectives</b>	<b>17</b>
1.1 Marine shellfish ecosystems and oyster restoration	18
1.2 European flat oyster: biology and aquaculture	22
1.3 Restoring <i>Ostrea edulis</i>	27
1.4 Research objectives	30
<b>2 Research background</b>	<b>33</b>
2.1 Collection and production of flat oyster seeds	34
2.2 Substrates for oyster restoration	35
2.3 Biosecurity aspects	36
<b>3 Core publications</b>	<b>41</b>
Chapter I	43
Chapter II	91
Chapter III	109
Chapter IV	133
Abstract of patent and co-authored publications	149
<b>4 Synthesis and perspectives</b>	<b>155</b>
4.1 Breeding techniques and its research needs for restoration	157
4.2 Natural and nature-based substrates for restoration	160
4.3 Biosecurity in ecological restoration	163
4.4 The future: Upscaling restoration and related open questions	165
4.5 Synthesis and conclusion	166
<b>5 References</b>	<b>171</b>
<b>Appendices</b>	<b>179</b>
Appendix I	181
Appendix II	213
Appendix III	221
<b>Acknowledgements</b>	<b>235</b>
<b>Declaration</b>	<b>239</b>





## List of abbreviations

<b>3D</b>	Three-dimensional
<b>AWI</b>	Alfred-Wegener-Institut Helmholtz Zentrum für Polar- und Meeresforschung (Alfred-Wegener-Institute Helmholtz Centre for Polar and Marine Research)
<b>BCE</b>	Before Common Era
<b>BfN</b>	Bundesamt für Naturschutz (German Federal Agency for Nature Conservation)
<b>BSH</b>	Bundesamt für Seeschifffahrt und Hydrographie (German Federal Maritime and Hydrographic Agency)
<b>E+E project</b>	Erprobungs- und Entwicklungsvorhaben (Testing and development project)
<b>eDNA</b>	Environmental deoxyribonucleic acid
<b>ENORI</b>	Essex Native Oyster Restoration Initiative
<b>EU</b>	European Union
<b>EMA</b>	Electro Mineral Accretion
<b>FFH</b>	Fauna-Flora-Habitat Directive
<b>FKZ</b>	Förderkennzeichen/Funding Reference
<b>IFREMER</b>	Institut Français de Recherche pour l'Exploitation de la Mer (French Research Institute for Exploitation of the Sea)
<b>INNS</b>	Invasive Non-Native Species
<b>MSFD</b>	Marine Strategy Framework Directive
<b>MRI</b>	Magnetic Resonance Imaging
<b>MPA</b>	Marine Protected Area
<b>N</b>	Number of individuals
<b>NSG</b>	Naturschutzgebiet (Nature Reserve)
<b>NORA</b>	Native Oyster Restoration Alliance
<b>OSPAR</b>	Oslo-Paris Commission ("OS" for Oslo and "PAR" for Paris).
<b>POLMAR</b>	Helmholtz Graduate School for Polar and Marine Research
<b>PROCEED</b>	Research project on the construction of a breeding facility for sustainable seed oyster production
<b>PVC</b>	Polyvinyl chloride
<b>RESTORE</b>	Research project on the restoration of European oyster stocks in the German Bight
<b>SER</b>	Society for Ecological Restoration
<b>UN</b>	United Nations
<b>UV</b>	Ultraviolet light



# Summary

Several marine ecosystems currently face severe degradation, in the form of habitat loss. As a consequence, humans are undertaking initiatives to restore species and habitats to restore and preserve ecosystem services and functions. Although there have been many initiatives to restock commercial marine species for fisheries and aquaculture, the restoration of marine habitats is a relatively new discipline. To recover ecosystem conditions that maintain their structure and function, ecological restoration was conducted and implemented by the Alfred-Wegener-Institut Helmholtz Zentrum für Polar- und Meeresforschung (AWI) and the Bundesamt für Naturschutz (BfN) for re-establishing lost and ecologically relevant biogenic oyster reefs in the frame of marine conservation measures in the German North Sea.

From 2016 to 2019, the AWI-led and BfN-funded RESTORE project actively investigated the technical and biological feasibility of restoration, from which this thesis originates.

In this context, three key topics (and their associated subtopics), relevant for the development of a successful restoration programme, are addressed in this thesis: I) Oyster supply - How can we provide ecological restoration efforts with substantial amounts of appropriate *Ostrea edulis* seeds (i.e. gametes, larvae and spat)? Which production techniques and knowledge exist? Which are appropriate for restoration? II) Supply of essential settlement substrate for the oyster life cycle - Which types of substrate to use in accordance with biological traits of *O. edulis*? Which types of substrate to use in accordance with legislative restrictions? III) Biosecurity aspects of oyster restoration - How to avoid the transfer of pathogens or invasive species during ecological restoration projects (focusing on seed production and substrate transfer)?

A review paper on the reproductive biology of *O. edulis* and on existing seed production techniques relevant for aquaculture and restoration (Chapter I) provides the knowledge basis for successful production, tailored to the demands of ecological restoration. It reviews four major seed production processes of *O. edulis*, discusses them in the context of different aquaculture and ecological restoration scenarios (e.g. techniques to minimise disease transmission, or to manage genetic variability), and identifies critical knowledge gaps that need to be closed to facilitate stable and substantial *O. edulis* seed production. Twenty substrate types are evaluated in the context of seed supply in natural environments (to enhance recruitment in the field) as well as in hatchery seed production (Chapter II). The approach is complementary (*in situ* and *in vitro* tests) and shows clear differences in settlement preferences of *O. edulis* larvae in relation to substrate type and environment. The results indicate that substrate selection (for practitioners) is essential to optimise *O. edulis* restoration practices. Biosecurity measures are investigated for the substrate supply chain (Chapter III) as well as for hatchery production (Chapter IV). The lack of established and recognised practical measures regarding the potential risks of translocations of non-native species, diseases and/or pests highlights the early stage of ecological restoration in Europe. A new method for sorting and processing shell substrate from France for restoration projects in Germany is presented here. Based on different treatments, first conclusions are drawn and future research directions suggested for the practice of importing shells for re-establishment at sea.

# Zusammenfassung

Eine Vielzahl mariner Ökosysteme sind heute stark gefährdet oder in einem schlechten ökologischen Zustand. Um diesem Trend entgegenzuwirken, werden Maßnahmen zur Wiederherstellung von Arten und Lebensräumen und damit verbundenen Ökosystemleistungen und -funktionen ergriffen. Obwohl es in der Vergangenheit viele Bemühungen zur Wiederaufstockung kommerzieller mariner Arten (für die Fischerei und Aquakultur) gab, ist die umfassende Wiederherstellung mariner Habitate eine relativ neue Disziplin.

Die Europäische Auster *Ostrea edulis* bildet einen bedeutsamen marinen Lebensraum, der einst in der Deutschen Bucht weit verbreitet war und dort eine wichtige dreidimensionale Struktur am Meeresboden bot. Nach einer Machbarkeitsstudie zur Wiederherstellung dieser Art in deutschen Meeresgewässern im Jahr 2014 wurde das vom AWI geleitete und vom BfN finanzierte Projekt RESTORE gestartet, um die technische und biologische Machbarkeit der Wiederherstellung biogener Austernriffe im Rahmen von Meeresnaturschutzmaßnahmen in der deutschen Nordsee zu erforschen und umzusetzen. Die vorliegende Arbeit wurde im Rahmen dieses Projekt durchgeführt und basiert auf dessen Fragestellungen.

Es wurden drei Schlüsselthemen untersucht, die für die Entwicklung eines erfolgreichen Wiederherstellungsprogramms relevant sind: I) Versorgung mit Austern - Wie können Wiederansiedlungsmaßnahmen mit ausreichenden Mengen von *O. edulis* Jungtieren versorgt werden? Welche Techniken und Kenntnisse sind bereits bekannt und geeignet? II) Die Versorgung mit geeignetem Ansiedlungssubstrat, das für den Lebenszyklus der Auster essentiell ist - Welche Substratarten sind aufgrund der biologischen Eigenschaften von *O. edulis* und unter Berücksichtigung naturschutzrechtlicher Vorgaben zu verwenden? III) Ökologische Sicherheitsstandards der praktischen Wiederansiedlung - Wie können Risiken des Eintrags exotischer und/oder invasiver Arten und/oder Krankheitserreger durch Transfer von Substrat oder Translokation von Austern vermieden werden?

Ein Reviewartikel (Chapter I) liefert die Wissensgrundlage für eine Saatausternproduktion, die auf die ökologischen Anforderungen der Wiederherstellung zugeschnitten ist. Es werden die vier wichtigsten Verfahren zur Produktion von *O. edulis* im Kontext verschiedener Aquakultur- und Restaurationsszenarien (z. B. Techniken zur Minimierung der Krankheitsübertragung oder zum Management der genetischen Variabilität) diskutiert. Das Kapitel schließt mit einer Liste von acht Forschungsthemen, die für eine nachhaltige und qualitativ wie quantitativ geeignete Produktion von *O. edulis* weiterverfolgt werden sollten. Darüber hinaus werden zwanzig Substrattypen im Zusammenhang mit ihrer Nutzung in der natürlichen Umgebung sowie in der Jungausternproduktion in Aufzuchtanlagen bewertet (Chapter II). Der Ansatz ist komplementär (*in situ* und *in vitro* Tests) und zeigt deutliche Unterschiede in der Ansiedlungspräferenz von *O. edulis* Larven in Abhängigkeit des Substrattyps und der Umgebung (natürliche Wiederansiedlung im Feld vs. Produktion in der Zuchtanlage). Die daraus resultierenden Ergebnisse zeigen, dass die Substratauswahl für die Optimierung der Wiederansiedlungspraxis von *O. edulis* von wesentlicher Bedeutung ist. Abschließend werden relevante Aspekte der ökologischen Sicherheitsstandards sowohl für die Lieferkette von passendem Ansiedlungssubstrat (Chapter III) als auch für die Austernproduktion in Aufzuchtanlagen (Chapter IV) untersucht. Das Fehlen etablierter und anerkannter praktischer Maßnahmen hinsichtlich der potenziellen Risiken der Einschleppung exotischer, invasiver Tiere, Krankheiten und/oder Schädlingen verdeutlicht das frühe Stadium der

Wiederansiedlungsmaßnahmen in Europa. Eine effektive Methode zur Sortierung, Reinigung und Aufbereitung von Muschelsubstrat aus Frankreich für die Nutzung in den deutschen Wiederansiedlungsprojekten wird hier vorgestellt. Basierend auf verschiedenen Behandlungsschritten werden künftige Forschungsbereiche für die Praxis des Imports von Muscheln zur Wiederansiedlung im Meer definiert.



**1**

# **General introduction and objectives**

## 1.1 Marine shellfish ecosystems and oyster restoration

Functioning ecosystems are essential for the maintenance of healthy oceans (Tett *et al.*, 2013). Worldwide, shellfish play an important role in aquatic ecosystems because of the ecosystem services they offer, such as the provision of shell material to build biogenic reefs (Gutiérrez *et al.*, 2003, zu Ermgassen *et al.*, 2020b; Figure 1). Despite their important role as habitat-builders in the marine ecosystem, an average of 85% of oyster reefs have been lost globally (Beck *et al.*, 2011), with a resultant loss of ecosystem functions and services. The Global Assessment of Shellfish Reefs at Risk (Beck *et al.*, 2011) revealed a rapid and widespread decline in native populations of habitat-forming bivalves.

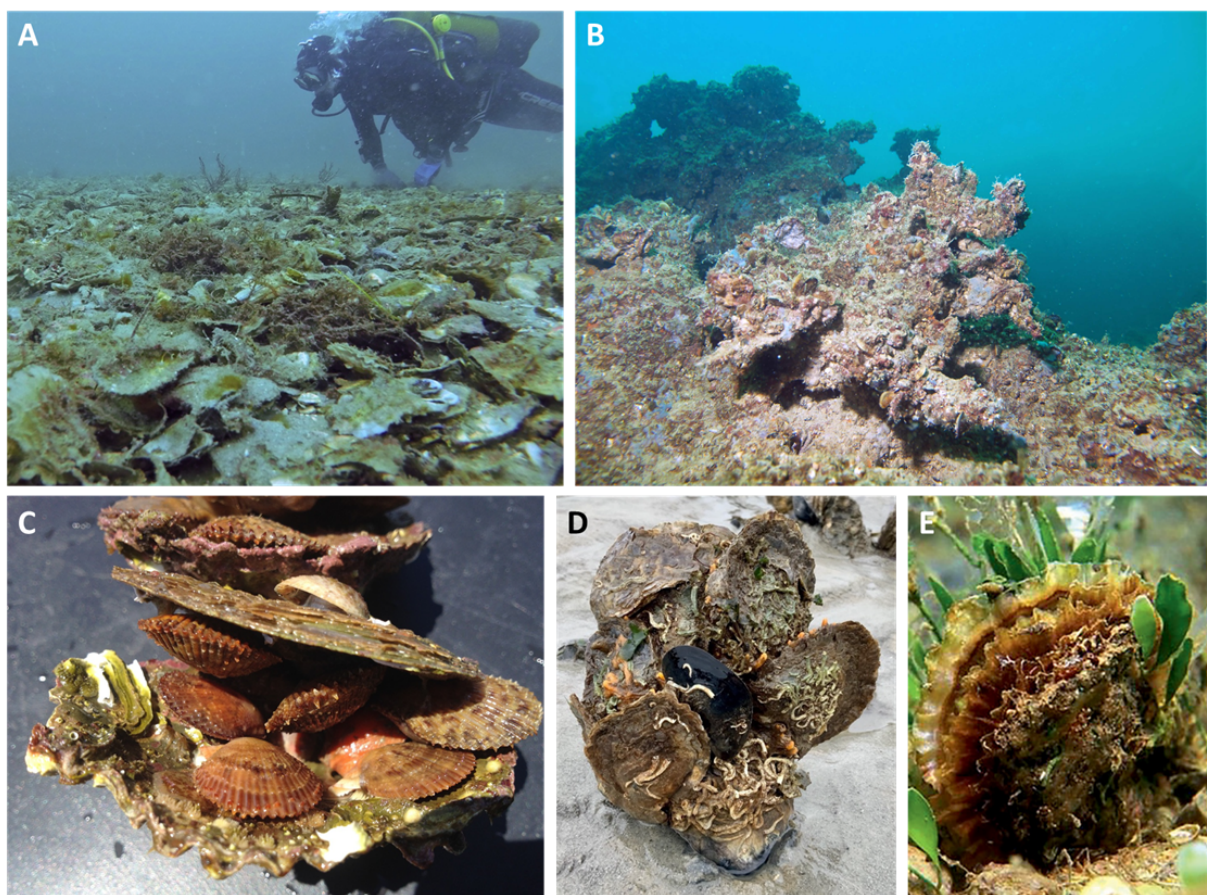

**Figure 1** Beds, reefs and shells of *O. edulis* providing ecosystem functions and services. (A) *O. edulis* beds in Brest Bay, France (Pouvreau *et al.*, 2021); (B) *O. edulis* reefs in the Black Sea, Bulgaria (Todorova *et al.*, 2009); (C) Dead *O. edulis* shells providing support for other species, here black scallop (Pouvreau, 2017); (D) *O. edulis* aggregation forming a 3D structure including other bivalve species, here blue mussel (Pouvreau *et al.*, 2021); (E) Living *O. edulis* shells providing support for marine plant species (Preston *et al.*, 2020).



In 2012, shellfish reefs were added to the list of wetland types eligible for designation for protection under the Ramsar Convention on Wetlands (Kasoar *et al.*, 2015). Since 2012, shellfish reef restoration has become a global practice conducted at increasing scales, from the Asia-Pacific region to America, Europe and the United Kingdom. Ecological restoration is now increasingly seen as an integral part of global ocean and coastal management (Westby *et al.*, 2019). Throughout Europe, oyster beds of the European flat oyster *Ostrea edulis* (*O. edulis*) have been declining since the 17<sup>th</sup> century. In some areas, such as in the Black Sea or in the German Bight, these beds have disappeared and the species is considered to be functionally extinct. Since 2012, the ecological restoration of *O. edulis* reefs has been a focus of marine conservation efforts in Germany, namely as a designated nature conservation measure of the German Federal Agency for Nature Conservation (BfN, 2020; Gercken & Schmidt, 2014).

### **Ecological restoration: definition**

The beginnings of what is known as ecological restoration as a discipline date back to the 1860s. It was founded in Southern Europe for forest environments and reforestation (Vallauri *et al.*, 2002) and its relevance has grown steadily over a number of different environments and scales, such as terrestrial, freshwater and also marine ecosystems (Clewell & Aronson, 2013). Today it is defined as the process of assisting the recovery of an ecosystem that has been degraded, damaged or destroyed and is recognised as an essential tool for mitigation and active conservation (Gann *et al.*, 2019). Ecological restoration aims to contribute to the protection and/or improvement of natural ecosystems, protect or to increase biodiversity, to support climate change mitigation and to improve human living conditions (health, well-being, food and water resources) (Gann *et al.*, 2019). Many actions are related to restoration, such as the reintroduction of native species for ecosystem services and functions (e.g. *O. edulis* to the German Bight) or the management through the elimination of non-native species in a given ecosystem (e.g. biosecurity aspects of translocations of materials and resources). While ecological restoration is the practice in the field, restoration ecology is the academic study of these processes. Restoration ecology is part of what is generally referred to as applied science and provides a reflection on scientifically substantiated observations, such as those compiled in this thesis.

### **Ecological role of oysters and their reefs**

According to the definition of engineer species by (Jones *et al.*, 1994), oysters are ecosystem engineers as they modify, maintain and create habitats by modulating the availability of resources for other species, directly or indirectly. Other examples of engineer species are trees, corals, and coralline algae. Due to their ability to build reefs (3D habitat structures) from the biotic material of their shells, but also through their nutrition mode (filter feeding), oysters play an important role for the surrounding ecosystem and the organisms associated with it (Box 1).

**Box 1 Biocoenosis and ecosystem: short definitions**

In 1877, the German teacher and zoologist Karl Möbius defined an oyster bed as a biocenosis (or community of life), a term that is today a well-established concept in biology (Moebius, 1877; Toepfer, 2011). He defined it as follows: "a community of living beings, a selection and number of species and individuals corresponding to the average external living conditions, which condition each other and maintain themselves durably by reproduction in a measured territory, is a biocenosis". He added that "any change in any factor of a biocenosis leads to changes in other factors of the same biocenosis (Moebius, 1877; Buschbaum *et al.*, 2003). In 1935, Arthur Tansley defined another well-known term in ecology: the ecosystem. The ecosystem links (the interactions) between the biotic community (biocenosis) and its physical environment (biotope) (Tansley, 1935).

In oyster reefs, a variety of ecosystem functions and ecosystem services (ESS, also called Natures' Contribution to People NCP; Millennium Ecosystem Assessment, 2005) are described that can be grouped into 4 main categories: 1) provisioning services, 2) regulating services, 3) habitat services, 4) cultural services (de Groot *et al.*, 2002). The first category concerns primarily the production of food, either directly (e.g. oysters themselves for human consumption) or indirectly (e.g. increase of commercially relevant fish and shellfish supported by oyster reef habitat), but also includes the production of raw materials such as shells (Jovic, 2019), genetic resources, medicinal resources, or ornamental resources (Thomas, 2022). The second category encompasses the capacity of oyster reefs to regulate biological processes essential to ecosystem functions and to human welfare, such as water quality. By filtering the surrounding water for food intake, nutrient deposition from the water column to the seabed and CO<sub>2</sub> and nitrogen fixation, as well as light conditions for photosynthesis are improved (Grabowski *et al.*, 2012). Active sediment deposition by oysters is proposed as a blue carbon sink due to related mechanisms of carbon capture and storage (Grabowski *et al.*, 2012; Lee *et al.*, 2020). Through the rough surface and three-dimensional structure of oyster reefs, they decrease and regulate erosion by attenuating wave heights in coastal areas functioning as breakwaters (Coen *et al.*, 2007; Cheong *et al.*, 2013). The third category covers habitat provision as oyster shells and their three-dimensional structures provide a valuable settlement substrate for sessile invertebrates, feeding and breeding grounds, as well as shelter for many organisms (Coen *et al.*, 2007; Grabowski & Peterson, 2007; Smaal *et al.*, 2019; Pogoda *et al.*, 2021). By providing such habitat, oysters influence the abundance, biomass and species richness of their environment, and support economically important fish and shellfish production in coastal areas (Luckenbach *et al.*, 2005; see category 1). Apart from shells, biological deposits can influence the enrichment of the sediment with certain minerals that can stimulate the growth of certain plant species (Peterson *et al.*, 1999). The aspects of preserving a gene pool or genetic variability is also discussed today (Farber *et al.*, 2002). The fourth category concerns the impact that oyster reefs may have on spiritual reflection and enrichment, cognitive development or artistic experience, as well as their historical and current relevance

as an important source of income connected to specific traditions and craftsmanship (de Groot *et al.*, 2002; Thomas, 2022).

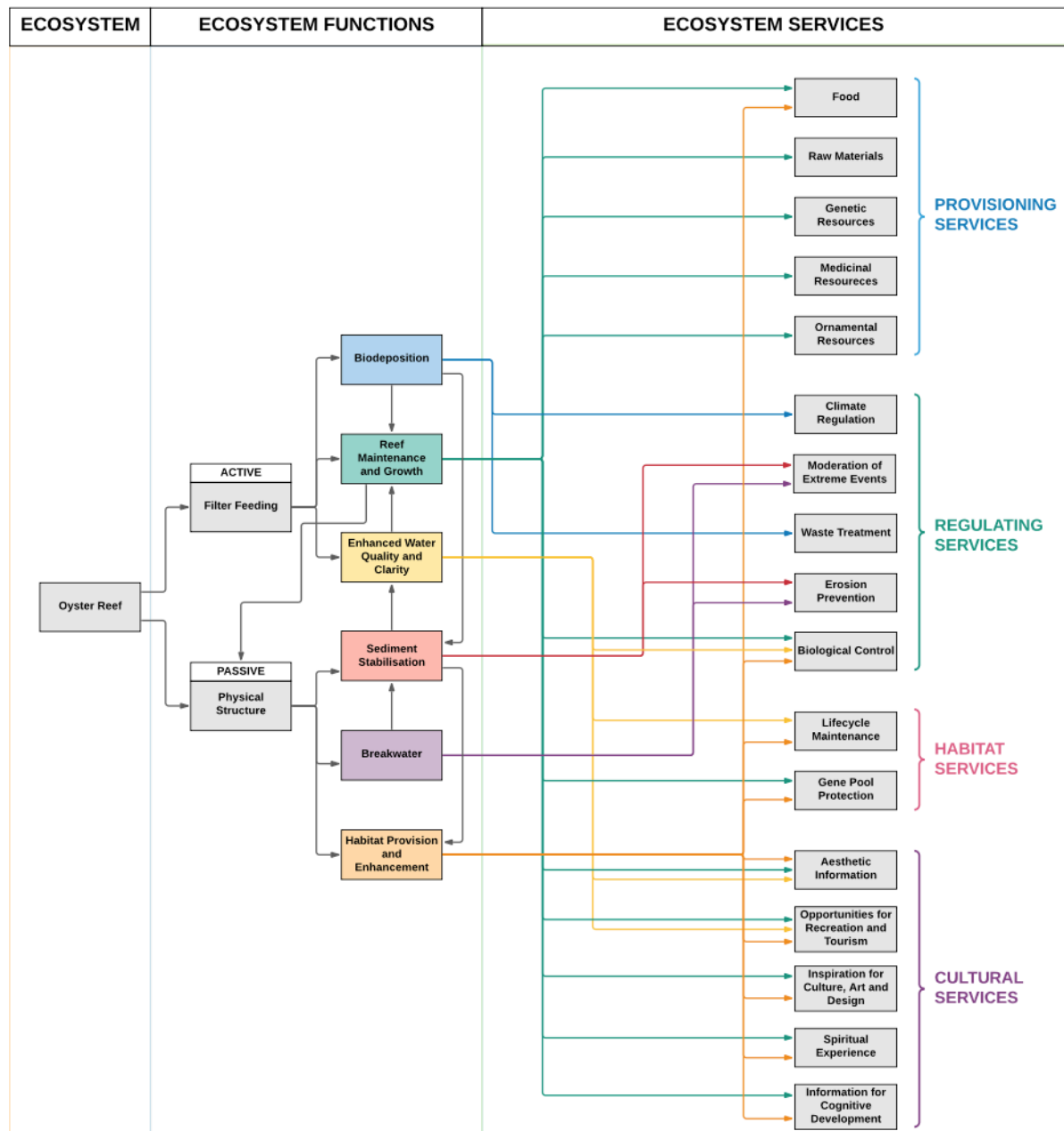

**Figure 2** Schematic diagram according to Thomas *et al.* (2022) of the network of ecosystem functions and ecosystem services of *O. edulis*.

In the North Sea, *O. edulis* is the native oyster species and the target species for oyster restoration (see section 1.2; Chapter I). Once abundant in the German Bight as well as in different parts of Europe, most oyster reef habitat is lost or severely degraded (Olsen 1883, Gercken & Schmidt, 2014). In the context of ecological restoration of these ecosystem

engineers and biogenic reef builders, the main objectives are the recovery of ecosystem functions of reef habitat and biodiversity enhancement (Pogoda, 2019; Figure 2), both contributing to objectives of the OSPAR Convention on the Protection of the Seas (OSPAR 2010), to the Habitats Directive (FFH Directive, 92/43/EWG) (Council of the European Union 1992) and to the Marine Strategy Framework Directive (MSFD) (Pogoda et al., 2020; Chapter I).

## 1.2 European flat oyster: biology and aquaculture

### Taxonomy, geographical range and habitat

The species *O. edulis* belongs to the genus *Ostrea*, (Linnaeus, 1758) (Box 2) characterised by the following morphology (Marteil, 1976): in the adult stage, the general shape of the shell is more or less circular; chalk clusters on the outer valves have a laminated structure; the straight valve is smooth or pleated, flat or domed, and may or may not have denticles on the inner edge on either side of the hinge. The original distribution of *O. edulis* is from 65° N, in Norway, to 30° N, at Cape Ghir, Morocco. The species naturally occurs in the Norwegian Sea, North Sea, English Channel, Celtic Sea, Bay of Biscay, and Mediterranean including Adriatic Sea, Black Sea and Azov Sea (Ivanov, 1964; Bromley *et al.*, 2016). Due to its high economic value, *O. edulis* was translocated outside Europe for cultivation purposes (Bromley *et al.*, 2016). It was imported and introduced to Australia in the mid-1800s and again in the 1940s, to South Africa in 1894, to the USA in 1947, to Japan in 1952, to Canada in 1957 and in the 2000s, to Mauritius in 1972, to Tonga in 1975, to Israel in 1976, to Fiji in 1977, to Mexico in 1984, to New Zealand in 1985 and to Namibia in 1990 (Funes & Jiménez, 1989; Bromley *et al.*, 2016). The success of these transfers is not part of this thesis, however, to our knowledge, with the exception of Canada, the USA and Namibia no recent records of the species' current distribution in these other introduction regions are available in the literature. *O. edulis* is a sublittoral species, inhabiting habitats below the low water line. Interestingly, vast natural banks of European oysters also occurred in deeper waters and offshore, down to fifty metres, e.g. in the North Sea and the eastern English Channel (Haelters & Kerckhof, 2009; Pogoda, 2012). Today, this species is extinct along the German and Belgian coast and *O. edulis* beds are under threat and/or decline in all the regions where they originally occurred (Pogoda, 2019; Sander *et al.*, 2021). The characteristic habitat type of all species within the genus *Ostrea* are waters of relatively high salinity, clear or with low turbidity (Marteil, 1976). Found in coastal areas, estuarine and marine habitats, the species thrive in subtidal and sublittoral areas with no or short emergence time (Martin *et al.*, 1997).

#### **Box 2** Taxonomic classification

Phylum / Class / Order / Family / Genus / Species  
Mollusca / Bivalvia / Ostreida / Ostreidae / *Ostrea* / *Ostrea edulis*

## Life cycle

Oysters of the genus *Ostrea* are asynchronous hermaphrodites with rhythmic consecutive sexuality (Marteil, 1976). Indeed, they can change sex several times during the same breeding season, starting in the first year of their life. The tendency to protandria (i.e. the initial adult phase is male) is common and the formation of male gametes occurs, in the post-settlement, in autumn (Davaine, 1853; Cole, 1942). In France, the species forms its gonads in spring, which then turn milky in appearance. They reproduce in summer and autumn in their natural environment (González-Araya, 2012). Although these oysters have the possibility to change their sex, the ratio of females to males seems (at least in laboratory and hatchery tests) to be relatively low, ranging from 13-20% females per batch of *O. edulis* (Bayne, 2017). Further investigations on natural populations and their proportion of females have yet to be carried out (Kamphausen *et al.*, 2011). The fertility rate of *O. edulis* varies between oyster age, studies and authors in the literature (Colsoul *et al.*, 2021), with reported values ranging between 0.09 and 1.8 million larvae per female. These variations may be due to various factors such as size and age of the individual, as well as temperature and food abundance during gametogenesis. The reproductive strategy of *O. edulis* females is internal brooding (as with the internal fertilisation). By keeping the progeny inside the mantle cavity (see Figure 3) of the female, the embryos are protected from external conditions (Mardones-Toledo *et al.*, 2015). In the male phase, *O. edulis* proceeds with sperm casting, where functional males release sperm in clusters, consisting of a central nucleus with the sperm attached by the head and the flagella radiating freely (Hassan *et al.*, 2017; Suquet *et al.*, 2018). During reproduction, the females filter the sperm clusters from the surrounding water and the fertilisation of the eggs takes place in the pallial cavity. The incubation of the fertilized eggs can last between five and eighteen days, depending on environmental parameters such as temperature and food abundance. After larval development during the internal brooding phase, 'swarming', or the release of the larvae from the female oyster, is induced by strong contractions of the adductor muscle and the opening of the shell, resulting in the ejection of "veliger" stage larvae in clouds (Erdmann, 1935). The pelagic period, where the veliger larvae swim and actively search for settlement substrate, can last between six and fourteen days. Again, these variations in the duration are due to various factors such as temperature and food availability. The size of this stage of larvae is between 160 to 200  $\mu\text{m}$  in diameter.

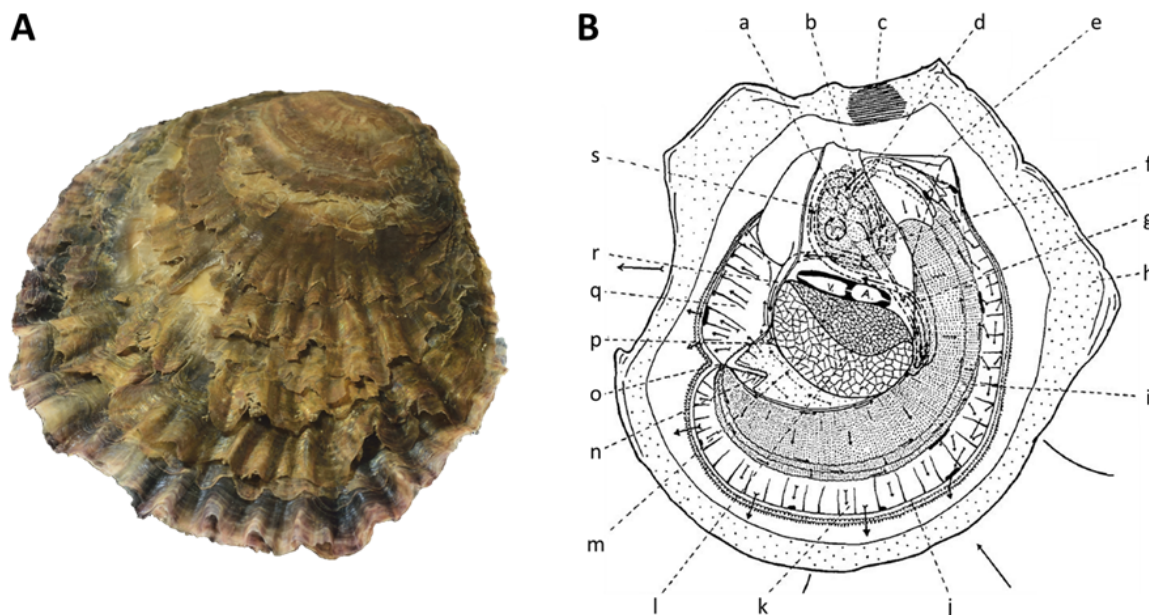
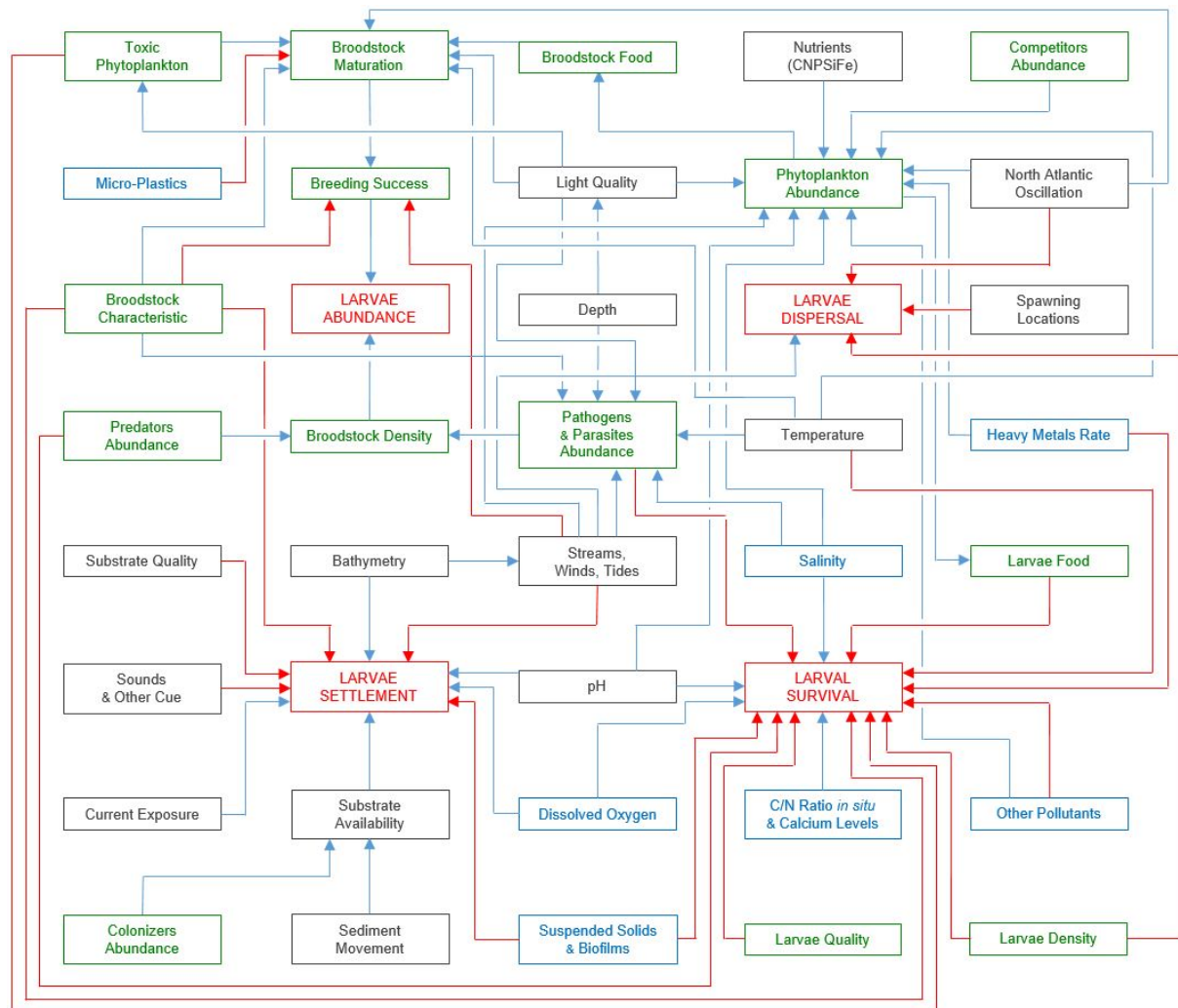

**Figure 3** **Photograph and anatomy of *O. edulis*.**

(A) Photograph of an upper valve of an adult *O. edulis* (©AWI/Solvin-Zankl); (B) Schematic anatomical view of an adult *O. edulis* (from above; upper valve and mantle fold removed) according and modified after Yonge (1926). Abbreviations: a: stomach; b: oesophagus; c: hinge; d: mouth; e: labial palps; f: digestive diverticula; g: style-sac; h: lower shell valve; i: gills; j: mantle fold; k: inhalent chamber; l and m: adductor muscle; n: mantle fold; o: digestive diverticula; p: anus; q: exhalent chamber; r: rectum; s: mid-gut.

At the end of its pelagic life stage, the larvae of *O. edulis* begin a metamorphosis, which leads to the formation of a foot and two black dots, or eye-spots, located in the centre of their shells. These 'pediveliger' larvae are ready for settlement onto a suitable substrate. In this settlement phase, the larvae have a size between 270 and 320  $\mu\text{m}$ . Once these larvae are permanently attached to the substrate they have chosen, these young oysters are now called "spat". Several short trials of larval attachment to a substrate can be observed before their final settlement (Colsoul *et al.*, 2020). The term "seeds" commonly refers to all possible products from adult oysters: gametes, embryos, larvae, spat, and juveniles. Many larvae perish during the metamorphosis phase, so any improvement to the required conditions for increased survival rates will drastically benefit the recruitment. In a controlled environment, such as a hatchery, the mortality rate varies between 30 and 60%. In the natural environment, many factors influence the recruitment rate from the larval to post-larval stages. Four main recruitment factors have been identified as crucial to a population's recruitment success, these are: 1) larval abundance; 2) larval survival; 3) larval dispersal; and 4) settlement rate. Figure 4 illustrates the large number of parameters related to these four factors. Though the list is not exhaustive, it highlights the complexity of managing these interactions in the natural environment for successful recruitment in a restoration project. Once settlement has occurred, the oyster spat reach sexual maturity after a minimum of one year (Merk *et al.*, 2020) and at this age are considered juvenile oysters. For commercial purposes, the smallest size of

harvestable adult oysters is ca. twenty grams, when they are between two and three years old.



**Figure 4 Potential drivers of *O. edulis* spat recruitment intensity in the German Bight.** Conceptual diagram of the four main parameters (red) and their associated potential factors (green: biological; blue: chemical; grey: physical). Arrows indicate expected major interactions and influences of selected environmental factors. Red pathways show research topics of the projects RESTORE (2016-2025) and PROCEED (2018-2024).

## Environmental factors and stressors

The complexity of the marine environment and how the associated factors (Figure 4) influence the successful recruitment of oyster larvae, is shown in Figure 4. On an ecological perspective, the abiotic environment (blue and grey boxes and pathways) is constantly interacting with the biotic environment (green boxes and pathways), regulating larval abundance, dispersal, survival and settlement in the field. Depending on natural ecophysiological tolerance ranges, or presence/absence, specific factors can be defined as stressors. Pathogens and parasites, such as bacteria, copepods, fungi, microalgae, polychaetes, protozoa, sponges and viruses, can induce diseases, mortalities or significant malformations in *O. edulis*. Predators and invasive species, such as shellfish drillers, can cause high mortalities throughout all life stages and even the complete collapse of *O. edulis* populations. Pollutants can adversely affect larval survival, as well as metabolism in young and adult oysters; with certain pollutants even affecting the reproductive capacity, thus generating long-term impacts on the development and renewal of oyster populations. On the one hand, these environmental factors are of relevance for successful recruitment in the field, but also equally relevant for larvae and seed production in aquaculture. In controlled hatchery environments, the regulation of mortality rates, settlement rates and disease, by regulating or minimizing stressors, is a common goal (see Chapters I-IV).

## Aquaculture as a tool for ecological restoration

For thousands of years, oysters have been harvested as an important and easily accessible food source, as well as for other purposes, with the use of oysters for healing wounds, for example, mentioned by Hippocrates of Kos during the 4th century BCE (Voultsiadou *et al.*, 2010). Aristotle initiated the scientific approach for oyster reproduction, examining the development of *O. edulis* in his treatise, '*On the Generation of Animals*', and documenting the history of seed breeding and production testing (Barthelemy-Saint Hilaire, 1887). In 17<sup>th</sup> century France, oyster aquaculture began in salt marsh pools on the Atlantic coast, followed by culturing stocks in constructed ponds (Héral, 1990). Seed oysters were collected or dredged and placed in these ponds until they grew to a size where they could be sold (Héral, 1990; Buestel *et al.*, 2009). From the 18th century on, natural beds of *O. edulis* were overexploited on the French Atlantic coast due to high demand. The decline in natural oyster stocks, all around Europe, raised the concerns of public authorities at that time, resulting in several attempts to restore stocks. These early attempts at stock restoration would now be classed as reseeded for commercial purposes, rather than for ecological restoration. During the same time, oyster aquaculture evolved, with production systems and technologies being developed according to efficiency, practicability and cost-benefit aspects (Figure 5). As scientific and technical knowledge advanced and the market expanded, with the introduction of new oyster species (e.g. *Crassostrea gigas*) to Europe, some traditional and environmentally friendly techniques were completely abandoned, in favour of more economically advantageous techniques, often to the detriment of the ecosystem. Putting ecological restoration of the European oyster successfully into practice, the correct selection



and adaptation of both traditional and modern techniques, in the context of environmental responsibility, needs to be the basis for long-term restoration success (see Chapters I, II, IV).

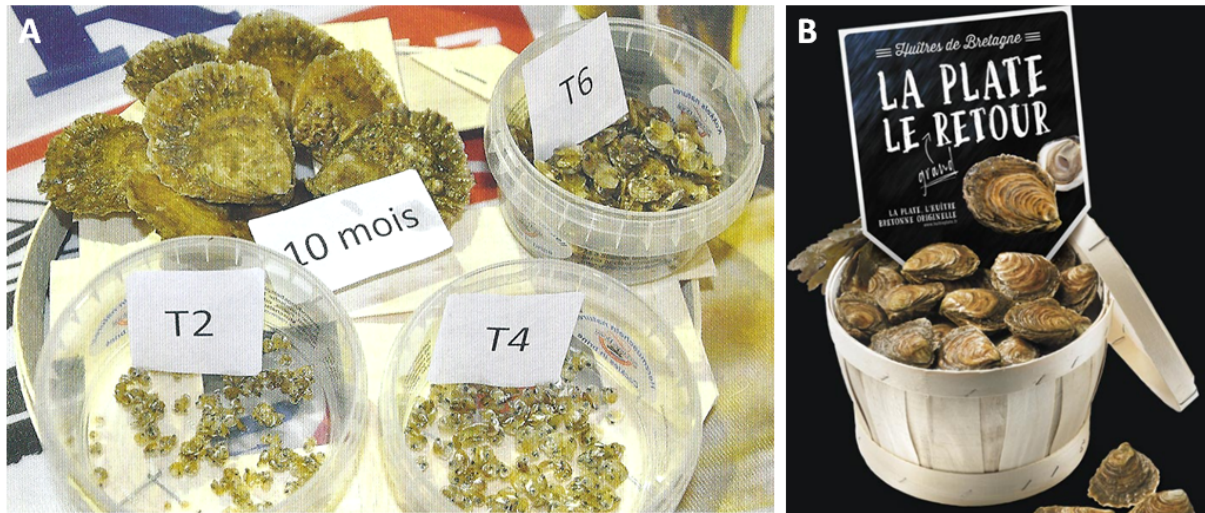

**Figure 5 Aquaculture of *O. edulis*: spat production and adult (commercial) production.** (A) Photograph of *O. edulis* spat sales of different sizes and ages at the Vannes trade fair, France (Larronde-Larretche, 2013); (B) Poster advertising flat oyster sales in Cancale, France (Anonymous, 2021).

### 1.3 Restoring *Ostrea edulis*

#### The Native Oyster Restoration Alliance in Europe

In European waters, few natural populations of the European flat oyster remain (Pogoda *et al.*, 2019), with both *O. edulis* and *O. edulis* beds, declared as ‘threatened and/or declining’ species and habitats, under the OSPAR convention (Haelters & Kerckhof, 2009). Biogenic reefs, such as oyster reefs, are further protected, and recommended for restoration, under the EU Habitats Directive (92/43/EEC). Within the last few years, efforts to restore this valuable habitat across its historical distribution, these European projects have increased constantly (Pogoda *et al.*, 2020a). In order to support the exchange between these diverse European projects, the Native Oyster Restoration Alliance (NORA) was founded in 2017 (Figure 6). Within its mandate, NORA actively connects science, technology, nature conservation, commercial aquaculture and policymaking and supports the development of recommendations and guidelines. In the Berlin Oyster Recommendation (Pogoda *et al.*, 2017), key limiting factors of oyster restoration such as seed production, site selection, settlement substrate, disease control and the need for biosecurity guidelines were identified, (Pogoda *et al.*, 2017; Pogoda *et al.*, 2019; Pogoda *et al.*, 2020a). The common goal of all NORA restoration projects is to either restore, or reintroduce, the European flat oyster and the habitat it provides. This must be in compliance with biosecurity and sustainability measures (NORA *Mission statement*; Pogoda *et al.*, 2020a), where no wild populations should be translocated,

new *O. edulis* stocks should be built up with ensuring high genetic variability and the risk of importing pathogens has to be kept at a minimum (Pogoda *et al.*, 2019). In order to achieve this overall goal, the most efficient production techniques, as well as what makes a suitable substrate for successful recruitment, need to be determined and these vital questions form the basis of this thesis (see section 2.3 and Chapters II-IV).

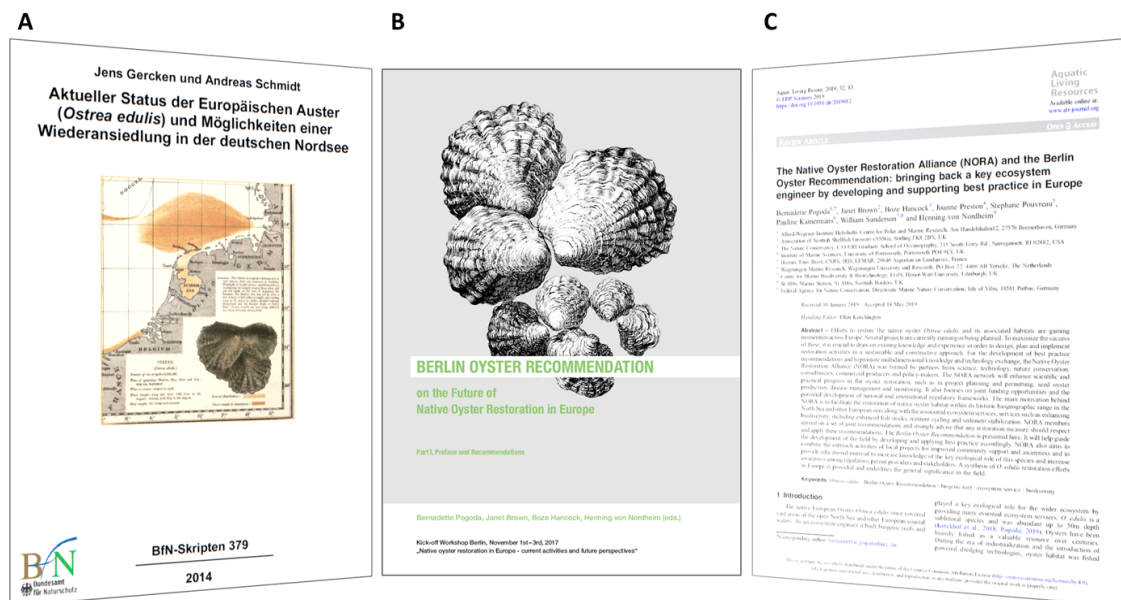

**Figure 6 Beginning of ecological restoration of *O. edulis* in Germany and the establishment of NORA.**

(A) Theoretical report of 2014 on the feasibility of restoration of *O. edulis* and its beds in Germany (Gercken & Schmidt, 2014); (B) Foundation in of a common international framework for practical restoration: The "Berlin Oyster Recommendation" (Pogoda *et al.*, 2017); (C) Review of the establishment of NORA and the development of best practice in ecological restoration of *O. edulis* in Europe (Pogoda *et al.*, 2019).

## Restoring *Ostrea edulis* within the German nature conservation context

In Germany, European flat oyster restoration is conducted within the scope of active nature conservation measures, initiated and steered by the German Federal Agency for Nature Conservation (BfN). As a Natura 2000 site, Borkum Reef Ground in the German Bight (also referred to as 'the German North Sea') is a designated marine protected area (MPA), classified within the framework of the EU Habitats Directive (1992). From this designation, the maintenance, or if necessary, the restoration to a favourable conservation status, for protected habitat types, such as biogenic reefs, is mandatory (Pogoda *et al.*, 2020c; BfN, 2020; Figure 7). Furthermore, Germany has defined "restoration of populations of regionally extinct species, such as European oysters" as an objective under the Marine Strategy Framework Directive (Directive 2008/56/EC). To achieve the conservation goals under these legislative requirements, each step, of any restoration operation, must include relevant sustainability,

biosecurity and nature conservation aspects. These aspects, all of which I contributed to, but are not part of this thesis, are detailed below.

*Regulatory Framework:* As European flat oyster restoration is a new conservation activity in the German Bight, the regulatory framework accordingly needs to be defined by relevant authorities, considering legal regulations and guidelines, as well as technical recommendations from international institutions, followed by the application for permits for practical restoration actions in the German North Sea (Pogoda *et al.*, 2020b; see section 3/Abstracts).

*Site selection:* A careful and comprehensive site selection is the basis for any ecological restoration measure, considering appropriate environmental conditions and the absence of impacts from non-indicated uses. Relevant site selection factors need to be identified and implemented for the restoration of *O. edulis* and *O. edulis* beds in the German North Sea (Pogoda *et al.*, 2020c; see section 3/Abstracts).

*Genetic diversity:* The German Bight is a recruitment-limited area (Westby *et al.*, 2019), since no European flat oyster populations are present. Therefore, restoration will depend on seed oyster sources, such as those produced in hatcheries (zu Ermgassen *et al.*, 2020a). In hatchery production, genetic diversity depends on the available genetic composition of the broodstock and the geographic variability of *O. edulis* genetics in general (Diaz-Almela *et al.*, 2004; Vera *et al.*, 2016). Large-scale restoration needs to ensure maintaining the highest possible genetic variability for the reintroduced populations (Lallias *et al.*, 2010; see section 3/Abstracts).

*Substrate:* No artificial materials such as plastic, metals or concrete should be used for ecological restoration in German MPAs. Accordingly, only natural or nature-based materials such as natural shells or natural stones can be used as settlement substrates. As the German Bight is a recruitment-limited and a substrate-limited area (Westby *et al.*, 2019), the propagation of the colonization substrate alone is not sufficient. Oyster restoration will only succeed via the introduction of both oysters and the suitable substrate (spat on shell, spat on reef). As very little is known about this, this aspect was one of the main foci of this thesis. (see section 2.2 and Chapters I, IV).

*Large-scale production:* In order to restore the once extensive *O. edulis* population, seed oysters need to be produced on a large scale. This poses challenges for the procurement of sustainable substrate, the production of an efficiently high number of seed oysters and the compliance with respective biosecurity standards (Bromley *et al.*, 2016). As no specific oyster production infrastructure, tailored to restoration demands, exists in Europe, and no commercial aquaculture of the European flat oyster exists in Germany, new ways of domestically producing large numbers of seed oysters and spat-on-shell need to be developed and established (see Chapters I, III, IV).

*Disease status and biosecurity:* The import of cultch or shellfish from foreign water bodies always has the associated risk of introducing non-native species and pathogens. With *O. edulis*, relevant pathogens include *Marteilia refringens*, *Bonamia ostreae* and *B. exitiosa* (Culloty & Mulcahy, 2007). In order to minimize the biosecurity risks of seed oysters and cultch translocation, technologies and practices need developing, to ensure a sufficient and safe seed oyster production for restoration practices (see Chapters III-IV).

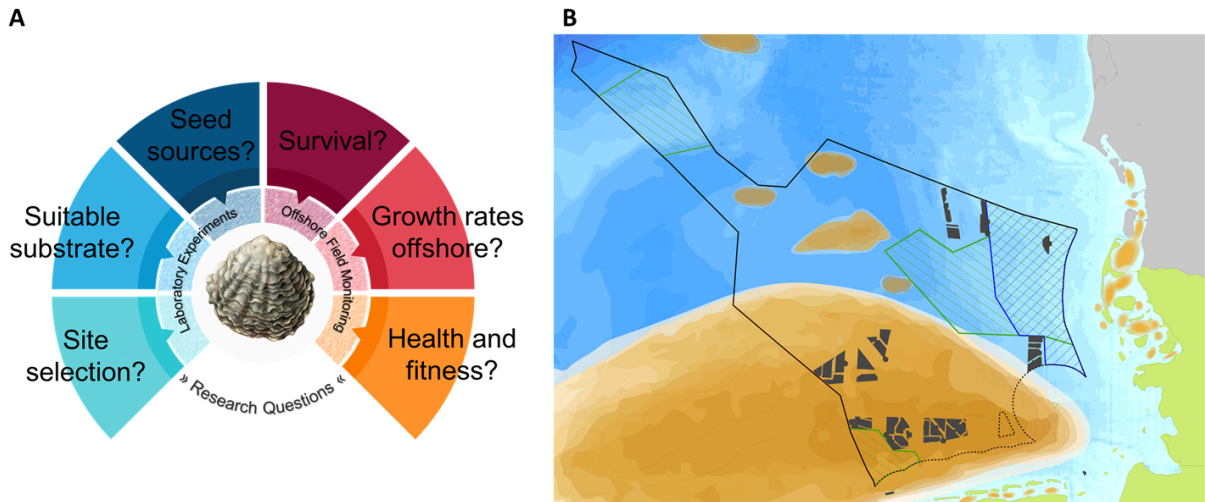

**Figure 7** Research focus and geographical context of the German *O. edulis* restoration efforts.

(A) Schematic of research questions and areas of investigation of the RESTORE project (2016-2019) (Oyster illustration from Scandinavian Fishing Year Book; Schema: ©B-Colsoul); (B) Map of the historical oyster banks (brown) in the German Bight (black outline: German Economic Exclusive Zone) and Natura 2000 sites (green outline), designated offshore wind farms in grey (©BfN/AWI/A-Essenberger).

#### 1.4 Research objectives

This thesis forms part of the combined efforts required for successful European flat oyster restoration in Europe, addressing several of the scientific knowledge gaps of restoration ecology and of applied science, in this specific field of marine habitat restoration. It was conducted under the umbrella of nature conservation measures and management goals, as part of the testing and development project RESTORE (FKZ 3516892016), as well as an integrative part of the applied science within the Native Oyster Restoration Alliance (NORA), and the project PROCEED (FKZ 3517685013) (von Nordheim, 2018; von Nordheim, 2021). Both projects and the NORA network (German Federal Program for Biodiversity) were conceived and funded by the German Federal Agency for Nature Conservation (Marine Directorate) with funds from the German Ministry for the Environment, Nature Conservation and Nuclear Safety.

The research objectives of this thesis were:

- (i) to review, synthesise and provide a well-considered critique of the existing knowledge on the reproductive biology and on the production of European flat oysters from two millennia (*Chapter I*);

- (ii) to investigate the settlement preferences of European flat oyster larvae on different substrates via combined laboratory and field experiments and to consequently assess a state-of-the-art type of substrate for ecological restoration (*Chapter II*);
- (iii) to investigate biosecurity risks of cultch translocation and to assess a secure method for the import and use of shells for ecological restoration (*Chapter III*);
- (iv) to develop the technical and scientific basis for ecological restoration of the European flat oyster in the German Bight, but also in the context of other European projects (*Chapters I-IV*).

The outcome of these investigations will not only provide a basis for ongoing restoration efforts in Germany, but also for the further development and scientific exchange with the relatively new, but constantly growing restoration community in Europe. International collaborations were an integral part of this thesis: Experiments were carried out in France and in Germany; the review on oyster seed production benefited from an international angle with co-authors who are experts in the field and are distributed across the main flat oyster production areas in Europe; the co-authored papers highlight the importance of this thesis for NORA (and vice versa) and the context of the rapidly evolving field of ecological restoration of *O. edulis*.



# 2

# Research background

## 2.1 Collection and production of flat oyster seeds

The collection and production of European flat oyster seeds (*O. edulis*) has been recorded in the literature for over two millennia (Barthélemy-Saint Hilaire, 1887). Techniques have evolved over time and with production areas, resulting in a plethora of data on collection and production techniques. However, this knowledge is widely scattered, historically, geographically and technologically: i.e. some data are outdated; others can only be applied in very particular environments; much information is distributed in different languages and some techniques were developed and abandoned later. It is important to consider that most of the seed production of *O. edulis* in Europe is carried out by the natural settlement of larvae on collectors in their environment (Anonymous, 2006; Figure 8). Other production methods, such as hatchery production, well known from other bivalve species of commercial interest, such as the Pacific oyster (*Crassostrea (Magallana) gigas*), have only been of minor interest for *O. edulis* in the past. This interest is currently being reviewed with a focus on the quantitative and qualitative needs of ecological restoration of *O. edulis* in Europe. The three main requirements for *O. edulis* seed production from hatcheries, necessary for restoration in recruitment-limited areas, are: maximum biosecurity risk reduction, preservation of genetic variability, and prevention of additional pressures on extant wild populations, such as avoiding the large-scale removal of individuals for use in restoration efforts. In addition to natural collection and hatchery production, other techniques exist or have existed in the past (Benovic, 1997; Dijkema, 1997; Strand & Vølstad, 1997) which might be of interest or relevance still in specific regions and/or ecological restoration settings. Overall, the utilised production techniques developed in tandem with scientific discoveries, such as the eco-physiological basics of oyster biology. Four main categories or research aspects of *O. edulis* are 1) feeding and growth; 2) diseases and pests; 3) selection and population genetics; 4) others (e.g. basic biology, ecophysiology, ecotoxicology). Today, whether in aquaculture or in restoration, the supply of European flat oyster seeds is limited and production technologies need further development (Pogoda *et al.*, 2019; Colsoul, 2013a; Colsoul, 2013b). In order to provide a clear picture of the research needed in order to optimise large-scale seed production of *O. edulis*, it is necessary to synthesise, scientifically analyse and communicate existing knowledge on, and limits of, oyster production techniques for current and future restoration practitioners.



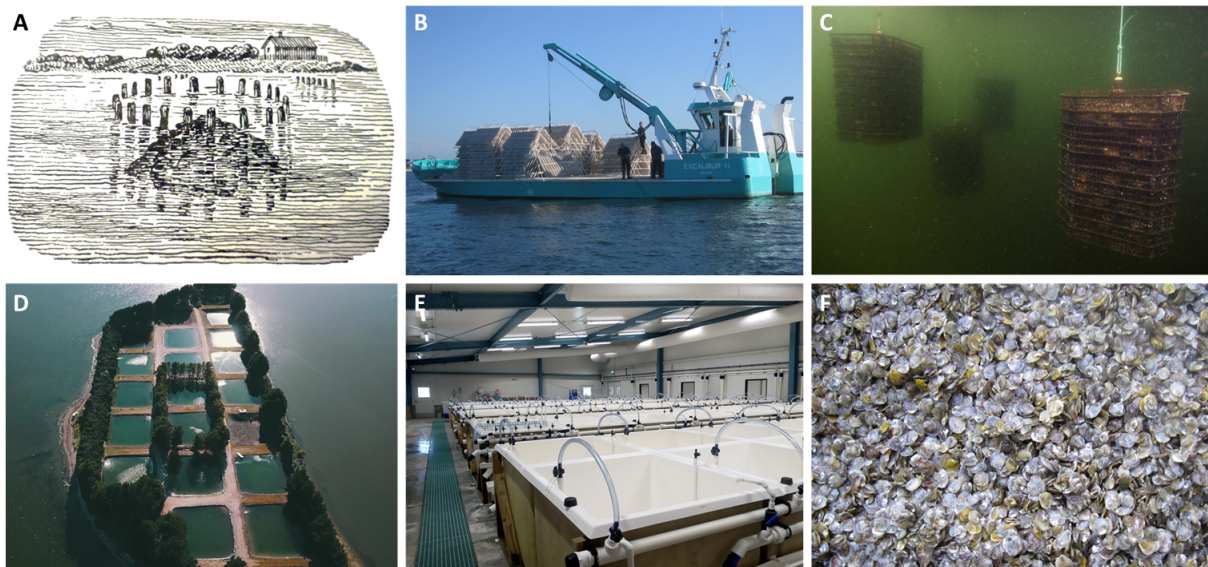

**Figure 8 Oyster seed supply: examples of collection and production methods.**

(A) Oyster pyramid construction for the creation of artificial reefs in the 1850s in Italy (Coste, 1861); (B) Setting of larval collectors for *O. edulis* on natural beds in Brittany, France (©Hélène Cochet); (C) Nursery of *O. edulis* spat in suspended lines at sea in Sweden (©Åsa Strand); (D) Aerial view of the Rossmore breeding ponds for *O. edulis* (©Tristan Hugh-Jones); (E) Marine bivalve hatchery in New Zealand: here the settlement phase in indoor tanks (©B-Colsoul); (F) Single seed (larvae settled on micro-cultch) of *O. edulis* produced in hatchery in the Netherlands (©B-Colsoul).

## 2.2 Substrates for oyster restoration

When *O. edulis* larvae are released by female oysters, after a temperature-dependent incubation period in the mantle cavity, these pelagic larvae will be mobile for a few days and subsequently move to an advanced stage of their metamorphosis. At this stage, these pediveliger larvae are actively searching for a substrate to settle on permanently, completing their metamorphosis and becoming 'spat'. In the absence of suitable quantities or qualities of substrate, the larvae will either continue swimming until their nutritional reserves are exhausted and die; or they settle on a non-optimal substrate, which might reduce the settlement success and recruitment. In shellfish restoration, sites are categorized as either substrate-limited or recruitment-limited areas, to define the required restoration approaches (Westby *et al.*, 2019). For both categories, the use of a multitude of substrate types can be observed throughout the world. In the USA, many substrates such as oyster and clam shells, various shells from dredging, porcelain, concrete, stabilized coal ash, sandstone, granite and even limestone (Goelz, 2017) are utilized as settlement substrates for the restoration of the American oyster (*Crassostrea virginica*). In Europe, ecological restoration of *O. edulis* is a relatively young field, and the first substrates used for this purpose were collectors from aquaculture (Figure 9). In France, the leading country for producing marine bivalves in aquaculture, the main substrates used are bivalve shells, such as from scallop (*Pecten maximus*), *O. edulis*, cockle (*Cerastoderma edule*), mussel (*Mytilus edulis*) or micro-cultch.

Since 2010, the use of limed plastic discs, or ‘*couppelles*’, has appeared as an alternative for different reasons (Pouvreau *et al.*, 2021). In recent years, most of the *O. edulis* spat collection has relied on using these plastic collectors, mainly due to their ease of storage and preparation, low price, and reusability. In Germany, restoration projects are developed for marine conservation and for MPA management. In this context, it is not possible to use artificial and/or hazardous materials for restoration in the wild. Hence, plastic materials but also concrete, metals and all non-natural materials are prohibited due to potential negative effects for the environment (Directive 92/43/EEC). In order to provide a knowledge base for sufficient seed production, tailored to the needs of ecological restoration of *O. edulis* in Europe, the identification and definition of appropriate substrates for achieving successful recruitment, is key.

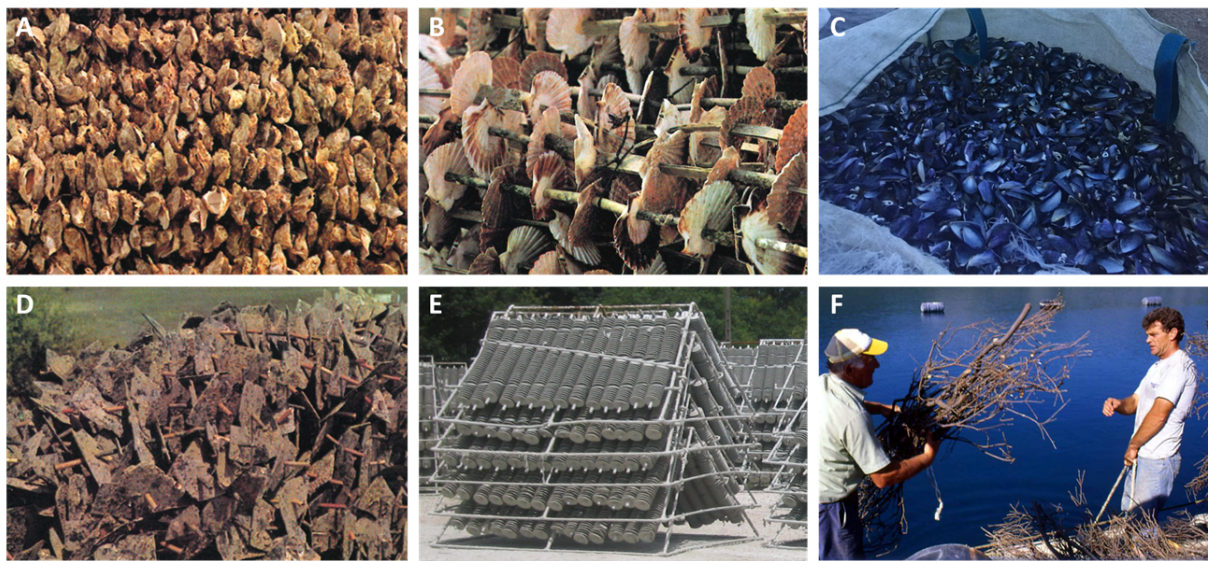

**Figure 9** Different *O. edulis* larvae collection systems and materials used in aquaculture. (A) Oyster shells (*O. edulis* and Pacific oyster shells mixed) tubed for suspension at sea (Anonymous, 1983); (B) Atlantic scallop shells tubed for suspension at sea (Anonymous, 1983); (C) Blue mussel shells in big-bag for laying on the sea bed or for the creation of net tubes (for suspension at sea) (©Tristan Hugh-Jones); (D) Roofing slates tubed for suspension at sea (Anonymous, 1983); (E) Limed plastic disc collectors on metal structures for laying on the sea bed (© H  l  ne Cochet); (F) Wooden bundles for suspension in lines at sea (   Ana Brato   Cetini  ).

### 2.3 Biosecurity aspects

Oysters were, and still are, vectors of diseases, pests and alien invasive species. Production methods, as well as trade that includes imports and exports, are important factors for the translocation and accidental introduction of associated organisms. For *Crassostrea gigas*, around sixty species originating from the Pacific Northwest are reported as having been introduced into Europe, attributed to voluntary and/or involuntary movements of these oysters, over a period of sixty years (Bromley *et al.*, 2016). Additionally, shell materials, such as oyster

shells, can be translocated, whether for their use in construction (Jovic *et al.*, 2019), for cultivation, as suspended collectors or on-bottom collectors at sea; or for habitat enhancement and restoration in substrate-limited areas. These movements of "dead" oysters and/or their non-sterilized shells are potential transmission vectors. The primary objective of the ecological restoration of *O. edulis*, not only in Germany, but also for most projects in Europe, is marine conservation and achieving a good environmental status of the ecosystem (Pogoda *et al.*, 2020). In this sense, the introduction of invasive species is an important risk that must be avoided for each intervention in the natural environment (David, 2020), be it the translocation of water, feed algae, adult oysters (Figure 10), larvae, spat, juveniles, or shellfish substrate. Invasive species, such as the gastropod drillers, *Ocenebra erinaceus*, and *Nucella lapillus*, can cause up to 90% mortality in an *O. edulis* oyster bed, in a single season (Pouvreau *et al.*, 2019). In addition to the risks of translocating alien species, the long-term effects of diseases and pests in restored ecosystems are of relevance. In the past, *Marteilia refringens* and *Bonamia ostreae* have caused large-scale disease outbreaks in oyster populations, with 90% stock mortality in some cases. In ecology, biosecurity is defined as "the control and management of the movement of living organisms, within an area and/or between different areas" (Anonymous, 2019). In animal husbandry, where concentrations of living organisms are higher, the control and management of movements regulations are extended to all potential vectors of disease and pathogens, including production equipment and materials, methodologies, labour, and respective environments (e.g. air, water). European flat oyster restoration is developing fast and a number of pilot projects have already been implemented. It is therefore essential to establish or to adapt biosecurity protocols for all material inputs, from seeds to settlement substrates, and over the complete restoration process. The numerous cases of oyster restocking disasters listed by Bromley *et al.*, (2016), including the introduction of pathogens from different populations, as was the case for *Bonamia* translocation between the USA and New Zealand, are prime examples of the importance for the application of adequate biosecurity measures in current, and future, restoration projects.



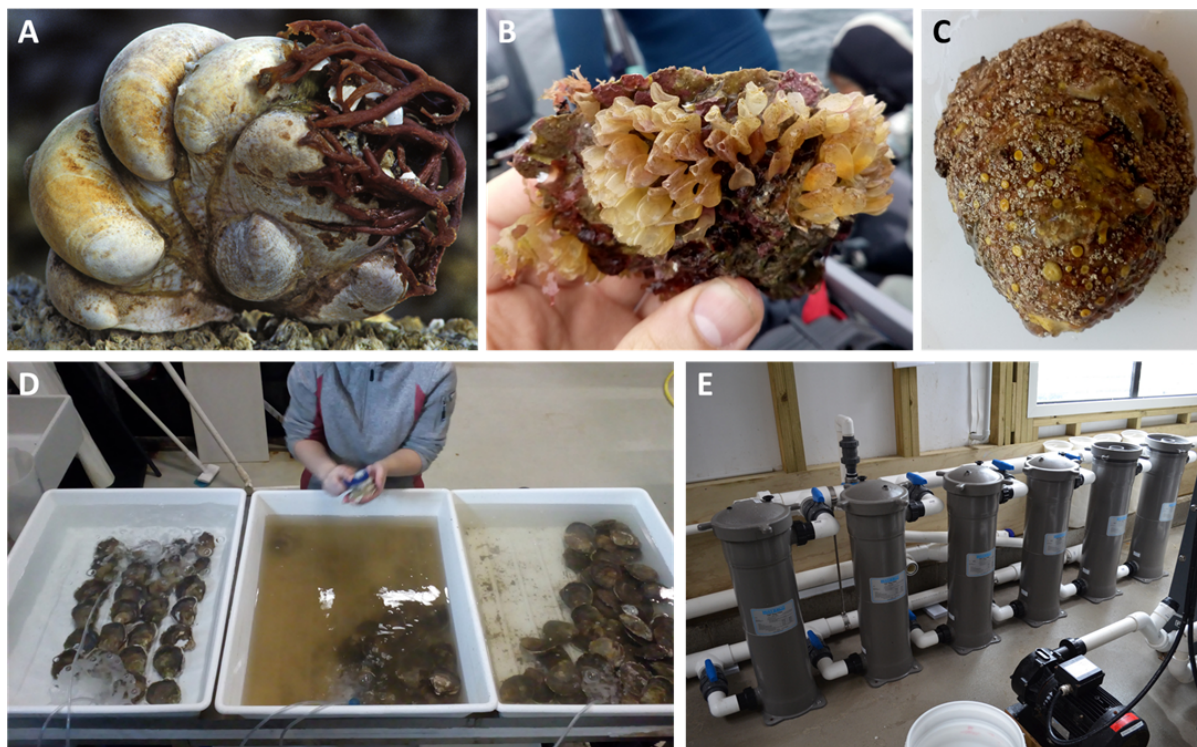

**Figure 10** Examples of organisms that may be translocated when importing *O. edulis* (live or dead shells) and examples of applied biosecurity.

(A) The alien invasive species and predator of *O. edulis* larvae: *Crepidula fornicata* (Decler, 2010); (B) Gastropod eggs *Ocenebra erinaceus* on *O. edulis* shell, (predator of *O. edulis* spat and adults) (©B-Colsoul); (C) Shell-boring sponge *Cliona celata* present on future *O. edulis* broodstock at Helgoland Oyster Hatchery (©B-Colsoul); (D) Manual scraping (before sterilisation) of adult oysters in a hatchery to remove macro-organisms from their shells (©B-Colsoul); (E) Seawater filtration system in a marine bivalve hatchery: here filtering down to 1µm (©B-Colsoul).





# 3

# Core publications

# Chapter I

## KEY FINDINGS

- ❖ Inventory and knowledge synthesis of *O. edulis* reproductive biology applied to seed production.
- ❖ Inventory and synthesis of knowledge on technologies and techniques for *O. edulis* seed production.
- ❖ Synthesis of the history of *O. edulis* seed production.
- ❖ Inventory and synthesis of diseases, pathogens, parasites, shell drillers, predators and pollutants affecting reproduction and/or larval survival and growth.
- ❖ Synthesis on population genetics, genetic selection and polyploidy of *O. edulis*.
- ❖ Existing aquaculture techniques which can be used and/or adapted to meet the needs of ecological restoration.
- ❖ Identification of four main technologies for *O. edulis* seed production.
- ❖ Literature review on seed production of *O. edulis*.
- ❖ Implications and the application of existing knowledge for ecological restoration.
- ❖ Identification of open questions and knowledge gaps.



# Chapter I

## SUSTAINABLE LARGE-SCALE PRODUCTION OF EUROPEAN FLAT OYSTER (*OSTREA EDULIS*) SEED FOR ECOLOGICAL RESTORATION AND AQUACULTURE: A REVIEW

Bérenger Colsoul, Pierre Boudry, Maria Luz Perez-Parallé, Ana Bratos Cetinic, Tristan Hugh-Jones, Isabelle Arzul, Nicolas Merou, Karl Mathias Wegner, Corina Peter, Verena Merk and Bernadette Pogoda

Published in *Reviews in Aquaculture*  
(2021; Open Access) / DOI: <https://doi.org/10.1111/raq.12529>

Supporting Information: Appendix I

# Sustainable large-scale production of European flat oyster (*Ostrea edulis*) seed for ecological restoration and aquaculture: a review

Bérenger Colsoul<sup>1,2</sup> , Pierre Boudry<sup>3</sup> , María Luz Pérez-Parallé<sup>4</sup> , Ana Bratoš Cetinić<sup>5</sup> , Tristan Hugh-Jones<sup>6</sup>, Isabelle Arzul<sup>7</sup> , Nicolas Mérout<sup>7</sup>, Karl Mathias Wegner<sup>8</sup> , Corina Peter<sup>1</sup> , Verena Merk<sup>1</sup>  and Bernadette Pogoda<sup>1,8</sup> 

- 1 Biological Institute Helgoland, Alfred-Wegener-Institut Helmholtz-Zentrum für Polar- und Meeresforschung, Helgoland, Germany
- 2 Faculty of Mathematics and Natural Sciences, Christian-Albrechts-Universität zu Kiel, Kiel, Germany
- 3 LEMAR, Ifremer, CNRS, IRD, Univ. Brest, Plouzané, France
- 4 Instituto de Acuicultura, Universidade de Santiago de Compostela, Santiago de Compostela, Spain
- 5 Department of Aquaculture, University of Dubrovnik, Dubrovnik, Croatia
- 6 Atlantic Shellfish Ltd, Cork, Ireland
- 7 LGPMM, Ifremer, La Tremblade, France
- 8 Wadden Sea Station, Alfred-Wegener-Institut Helmholtz-Zentrum für Polar- und Meeresforschung, List/Sylt, Germany

## Correspondence

Bérenger Colsoul, Alfred-Wegener-Institut Helmholtz-Zentrum für Polar- und Meeresforschung, Am Handelshafen 12, 27570 Bremerhaven, Germany.  
Email: berenger.colsoul@awi.de

Received 20 March 2020; In Revised form 3 December 2020; accepted 17 December 2020.

## Abstract

The conservation and active restoration of European flat oyster (*Ostrea edulis*) populations are a major focus of ecological restoration efforts to take advantage of the wide-ranging ecosystem functions and services this species provides. Accordingly, additional and new demands for seed oysters have arisen. In commercial aquaculture (mariculture), the production of *O. edulis* is still largely based on natural seed collection. Considering the specific requirements, related to ecological restoration, such as the absence of pathogens and the preservation of high genetic diversity, the current supply is insufficient. Despite the development of breeding and controlled reproduction techniques for this species since the late 1930s, seed production today is mainly based on empirical concepts. Several of the issues that producers still face are already subjects of research; many others are still unanswered or even unaddressed. This review provides a summary of all available knowledge and technologies of *O. edulis* seed production. Furthermore, it provides a detailed reflection on implications for restoration, future challenges, open questions and it identifies relevant research topics for sustainable seed supply. The study covers the following aspects on (i) biology of the species, (ii) stressors – including pathogens and pollutants, (iii) genetics, (iv) history of production technologies, (v) seed production in ponds, (vi) seed production in hatcheries. Future research needs on sex determination, gametogenesis, cryopreservation, nutrition, selective breeding, pathogens and disease, and the development of reliable protocols for production are highlighted.

**Key words:** breeding, hatchery, reproduction biology, shellfish, spat, technology.

## Introduction

In Europe, the conservation of the European flat oyster *Ostrea edulis* (Linnaeus 1758) populations is in the focus of ecological restoration efforts to profit from the ecosystem services of this biogenic reef-engineer species. Praised for

its culinary, medicinal and ecological virtues, this oyster species is today at the core of many scientific projects or actions by governmental and non-governmental organizations for its aquaculture, restocking, restoration or reintroduction in its former range all over European coasts (Pogoda *et al.* 2019). *Ostrea edulis* and its beds (referred to

here as ‘reefs’) provide many ecosystem services and functions such as substrate formation and biodiversity enhancement (Haelters & Kerckhof 2009; Todorova *et al.* 2009). It therefore contributes to objectives defined by: the OSPAR Convention for the Protection of the Marine Environment of the North-East Atlantic, the EU Habitats Directive (Directive 92/43/EEC) and the EU Marine Strategy Framework Directive (Directive 2008/56/EC) (Pogoda 2019).

Over the 20th century, European stocks of *O. edulis* have been severely depleted by overfishing, leading to numerous reseeded and restocking projects, mostly based on translocations (Bromley *et al.* 2016a; Pogoda 2019). Those included 19th and 20th century translocations from adult, seed and juveniles of *O. edulis* within Europe and from non-European areas to Europe (Bromley *et al.* 2016a). These shellfish movements, as a consequence, are most likely responsible for the introduction and further dispersal of parasites and pests such as the introduction of bonamiosis into Europe from the USA in 1979, the introduction of gill disease into Wales from the Netherlands in the 1960s and the introduction of Asian rapa whelk into the Black Sea from the Far East in 1949 (Zolotarev & Terentyev 2012; Brenner *et al.* 2014; Bromley *et al.* 2016a). Some of these diseases and pests have drastically reduced or depleted the stocks and beds of *O. edulis* throughout European waters (Zolotarev & Terentyev 2012; Pogoda 2019). As the aquaculture of European flat oyster has also been affected extensively by some diseases, a large part of the oyster industry has turned away from cultivating this species (see Section Bonamiosis). This has had obvious consequences for the development of production technologies when compared to other shellfish species of commercial interest, such as the Pacific oyster (*Crassostrea gigas*).

Today, as Lallias *et al.* (2010) have listed, oyster population restoration can be conducted in three distinct ways: (i) The strategy of releasing larvae into the wild; (ii) The strategy of producing older seeds (spat) and releasing them into the wild; (iii) The strategy of translocating adult oysters. Considering the risks of transferring pathogens and invasives by adults translocations and the potential negative impact on remaining wild beds, the third strategy should not be applied (Bromley *et al.* 2016a; Pogoda *et al.* 2019). Given the fertility rate of *O. edulis*, the low survival rate of larvae in the wild, the availability or the lack of suitable substrates for settlement (Smyth *et al.* 2018; Colsoul *et al.* 2020), as well as the lack of control within a restoration area, the first strategy is certainly not viable unless applying it under specific, risk limiting conditions. Consequently, the second strategy, seeding with juveniles (i.e. seed or ‘spat’), seems to be the best option for *O. edulis* restoration projects.

Currently, both aquaculture and ecological restoration are limited by access to seed as the current production

techniques does not allow for a regular, substantial and sustainable seed production meeting the specific expectations and objectives of the two sectors (i.e. aquaculture and restoration; Pogoda *et al.* 2019). In addition to the previously mentioned shortage of seeds, there are also different objectives in regard to the need in seed quality. The needs of *O. edulis* aquaculture are generally focused on: survival, growth, weight gain, gastronomic aspect (visual and content), tolerance to exoneration or resistance to diseases, whereas for ecological restoration, the needs are mainly high genetic variability and survival and/or disease tolerance (Sas *et al.* 2020).

The higher the genetic diversity within a population, the less vulnerable it is for any disturbance as for example being infected and depleted by a pathogen (Hughes *et al.* 2008). According to this, it seems obvious that any ecological restoration project will aim for the highest possible genetic diversity in order to increase population resilience (e.g. fitness, response to diseases), avoid inbreeding and ensure its long-term adaptability (e.g. changing environment).

Today, a plethora of ways of producing or collecting *O. edulis* seed exists, ranging from traditional methods based on sea-based collection of seed to very modern production in controlled environments, that is land-based hatcheries. Protocols for the production and collection of *O. edulis* seed depend on site conditions, technology and the physiological condition of the spawning broodstock. The knowledge about ecophysiological and environmental drivers is still limited for this species and this limits the development of successful breeding methods. It is essential to define and compare technical achievements, research gaps, advantages and disadvantages of different seed-supply technologies to identify optimal seed quality for the specific goals and settings of ecological restoration.

For this reason, this review focuses on the description of production systems (Chapter 7) and biological knowledge of *O. edulis* (Chapter 3–4).

In addition, in Chapter 6, the history of seed production is reviewed to understand present production systems and future development. Depending on the historical period, technological progress and geographical location, the supply of seed had different goals. The technological progress was always directly related to the goals, which were mainly shaped by the demands of their historical period. From the beginnings of aquaculture to today’s ecological restoration, a short synthesis of the historical development of the supply of seed from *O. edulis* is presented here.

In order to overcome current barriers and limitations of oyster restoration, the Native Oyster Restoration Alliance (NORA), a network of scientists/institutions, nature conservation bodies/organizations and aquaculture producers was founded and seed production was identified as a key limiting factor for restoration and defined as a critical

knowledge gap (Pogoda *et al.* 2019). Against this background, the aim of this review was to collect and integrate all available knowledge to identify useful approaches for successful *O. edulis* seed production, to meet current and future demands of ecological restoration efforts with the European flat oyster.

## Methods

The search for bibliographic data was conducted in four steps. The first was the collection of peer-reviewed literature in the three major bibliographic search engines: Google Scholar, ISI Web of Science and Scopus Document Search (Appendix S1). Keywords used for the literature search were *O. edulis*, European flat oyster and European oyster. These main keywords were then combined in pairs with relevant keywords concerning the prevailing subjects in this review (for a detailed description of the search process see Supporting Information). In addition to the fundamental search of existing literature, an alert for new publications (all keywords) was set up on Google Scholar during the writing phase of the review in order to add the most recent data possible. As the Latin name of *O. edulis* Linnaeus 1758, changed over time, new searches (name alone and paired with second keyword) were carried out with the list of 20 Latin names (Table 1). The resulting literature (Table 1) was then consulted individually to determine its potential value to this review.

Since many peer-reviewed publications were published in other languages, the second step of the bibliographic research included the collection of data in languages other than English. The keywords already used in the first step were translated to Norwegian, German, Dutch, French and Spanish and again searched for in Google Scholar.

In the third step, the data were supplemented by searching for relevant information in the grey literature, as the documentation of European oysters production began very early (4th century BCE) and techniques were often developed without publication in peer-reviewed articles.

The fourth and last step was performed after analysing the relevance of the documents collected in the previous steps. Once the literature was sorted, the references of each of the documents were screened for additional scientific titles and journals. Those were added to the final bibliography on which this review is based on (Appendix S2).

Four limitations to this bibliographic search were identified: (i) Some of the articles, books, chapters, reports and other documents of interest are old, not digitized, printed in a small number of copies or even stored in foreign libraries and therefore difficult or not possible to access; (ii) Patents were excluded and numerous reports, PhD

**Table 1** Synonym Latin names of *Ostrea edulis* (according to Gofas (2004)): List of the number of results by names in the database Google Scholar, ISI Web of Science and Scopus Document Search

Species	Descriptor	Google Scholar	ISI Web of Science	Scopus Document Search
<i>Monoeciostrea europa</i>	Orton, 1928	1	0	0
<i>Ostrea adriatica</i>	Lamarck, 1819	4	1	0
<i>Ostrea corbuloides</i>	Danilo and Sandri, 1855	1	0	0
<i>Ostrea cristata</i>	Born, 1778, (Poli, 1795)	84	1	5
<i>Ostrea cumana</i>	Gregorio, 1883	1	0	0
<i>Ostrea cyrnusii</i>	Payraudeau, 1826	2	0	0
<i>Ostrea depressa</i>	Philippi, 1836	9	1	0
<i>Ostrea exalbida</i>	Gmelin, 1791	1	0	0
<i>Ostrea hippopus</i>	Lamarck, 1819	39	1	2
<i>Ostrea lamellosa</i>	Brocchi, 1814	363	4	4
<i>Ostrea leonica</i>	Fréminville in Taslé, 1870	1	0	0
<i>Ostrea parasita</i>	Turton, 1819	0	0	0
<i>Ostrea parasitica</i>	Turton, 1819	40	3	0
<i>Ostrea rostrata</i>	Gmelin, 1791	9	5	0
<i>Ostrea saxatilis</i>	Turton, 1807	2	0	0
<i>Ostrea scaeva</i>	Monterosato, 1915	2	0	0
<i>Ostrea striatum</i>	da Costa, 1778	1	2	0
<i>Ostrea sublamellosa</i>	Milachewitch, 1916	76	0	0
<i>Ostrea taurica</i>	Krynicky, 1837	58	1	0
<i>Ostrea vulgare</i>	da Costa, 1778	1	1	0

theses and academic studies were not considered until the fourth step cited above; (iii) Language was a major limitation in the database search and the understanding of the documents: English, French, German, Norwegian and Spanish were translated; (iv) The totality of bibliographic research was limited to the Latin alphabet.

After analysing the data collected, it was decided that this review will not cover, or will only cover very partially, the following phases and/or elements of production: site selection, water treatment, substrate/collector production, nursery, food production (i.e. microalgae), technical materials and education.

## Biological background

Relevant biological aspects of *O. edulis* are presented here to understand seed production procedures, and to discuss difficulties in production and needs of technological advances. This chapter does not intend to provide a detailed overview of the biology of *O. edulis* but provides a

review of important elements that affect reproduction, spatfall and other operational phases within the oyster production cycle.

## Genus *Ostrea*

### Taxonomy

According to the World Register of Marine Species (Gofas 2004), 408 species are currently listed within the genus *Ostrea* which was first described by Linnaeus in 1758. After removing uncertain taxonomy, synonyms, misidentifications and extinct species, the genus *Ostrea* today considers 16 living species (Table 2). All these species breed their embryos between the demibranchs in the pallial cavity until swarming, for example the release of larvae (Chaparro *et al.* 2018).

From 1758 onwards, *O. edulis* is described as a species in the genus *Ostrea*. However, the species was described over time and places also by authors other than Linnaeus, using different Latin names; all of them now summarized and reclassified as *O. edulis* (Table 1). A large number of vernacular names in different alphabets and other forms of writing exist, all of which are describing the species *O. edulis* (Anonymous 2008).

### Species identification within the genus *Ostrea*

The morphology of the species within the *Ostrea* genus is in some cases relatively similar, for example *Ostrea stentina*, a sympatric species of *O. edulis* found in the waters of Tunisia, Spain and Portugal (González-Wangüemert *et al.* 2004). Although it is very difficult to morphologically distinguish the two species in the juvenile stages, *O. stentina* remains smaller as adults.

The Australian flat oyster (*Ostrea angasi*) is also very similar to *O. edulis* (Crawford 2016). On the morphological level, the species appears very close already when observing the larval sizes and other reproductive characteristics (Table. 2). In addition, Hurwood *et al.* (2005) even suggests that *O. angasi* is a recent colonizer of Australia or that these two taxa are, in fact, the same species. Morton *et al.* (2003), on the other hand, distinguishes these two species using mitochondrial DNA markers.

Although other species of the genus *Ostrea* were introduced into Europe (e.g. *O. chilensis*, *O. angasi*, *O. puelchana* reported by Grizel *et al.* (1983), Bougrier *et al.* (1986) and Pascual *et al.* (1991) none of these species seems to have proliferated and thus cause identification difficulties within the current European range of *O. edulis*.

## Geographical range

### European range

*Ostrea edulis* is distributed from 65° North in Norway to 30° North at Cape Ghir in Morocco. The species naturally

occurs in the Norwegian Sea, North Sea, English Channel, Celtic Sea, Bay of Biscay and Mediterranean including Adriatic Sea, Black Sea and Azov Sea (Ivanov 1964; Bromley *et al.* 2016a).

The characteristic habitat type of all species within the genus *Ostrea* are waters of relatively high salinity, clear or with low turbidity (Marteil 1976). Found in coastal areas, estuarine and marine habitats, the species thrives in subtidal and sublittoral areas with no or short emergence time (Martin *et al.* 1997).

In 2018, the European countries producing *O. edulis* in aquaculture in the order of volume ( $\geq 1$  ton in live weight per year) produced were: France, Spain, Ireland, Croatia, UK, Norway, Montenegro, Portugal and the Channel Islands (Fig. 1). Together, these countries produced to a total of ca. 1407 tons of oysters (FAO 2020). Despite this, production exists in Sweden, Denmark and the Netherlands.

The total production per catch of the fishery in 2018 (in Europe) was ca. 684 tons. The producing countries in order of volume ( $\geq 1$  ton in live weight per year) were Denmark, Croatia, Spain, Tunisia, France, Portugal, UK, Sweden and Greece.

The considerable decrease in production (aquaculture and fishery catches) observed over the last 5 years highlights the difficulties in obtaining seeds for both the aquaculture and the restoration sector.

### Extended range

*Ostrea edulis* was translocated outside Europe mainly for cultivation purposes (Bromley *et al.* 2016a). It was imported particularly to Australia in the mid-1800s and 1940s, to South Africa in 1894, to the USA in 1947, to Japan in 1952, to Canada in 1957 and in the 2000s, to Mauritius in 1972, to Tonga in 1975, to Israel in 1976, to Fiji in 1977, to Mexico in 1984, to New Zealand in 1985 and to Namibia in 1990 (Funes & Jiménez 1989; Bromley *et al.* 2016a).

The success of these transfers has not been studied here. However, to our knowledge, with the exception of Canada, the USA and Namibia (see below), no recent data have been found in the literature.

Aquaculture records exceeding 1000 tons exist in the USA (from 1984 to 2013), in South Africa (only in 1992) and in Namibia (from 2003 to 2015; FAO 2020). In addition, a natural population of *O. edulis* (as non-native species) has been established in Canada, in the province of Nova Scotia (Vercaemer *et al.* 2006) and in the province of New Brunswick (Burke *et al.* 2008a; Burke *et al.* 2008b).

## Sex change and sex ratio

*Ostrea edulis* is an asynchronous hermaphrodite with a rhythmic consecutive sexuality: several sexual inversions

**Table 2** Life cycle characteristics of the genus *Ostrea* (modified after Castanos et al. (2005) and Gofas (2004))

Species	Descriptor	Maximal no. of brooders (%)	Days of incubation	Days of planktonic life	Size of egg (µm)	Size of larvae (µm)	Larval setting size (µm)	Fertility (larvae × 10 <sup>6</sup> )	References
<i>Ostrea algoensis</i> ‡	Sowerby II, 1871	NA	NA	NA	NA	NA	NA	NA	Jozefowicz and Foighil (1998)‡
<i>Ostrea angasi</i> ‡	Sowerby II, 1871	16	NA	12–20	NA	186–203	300–320	0.03–1.52	Suquet et al. (2018)†, Jozefowicz and Ó Foighil (1998)‡
<i>Ostrea chilensis</i> ‡	Philippi, 1844	2.6–48	21–56	5 min–48 h	220–323	390–556	426§–556	0.05–0.06	Suquet et al. (2018)†, Jozefowicz and Ó Foighil (1998)‡, Buroker (1985)§
<i>Ostrea circumpecta</i> ‡	Pilsbry, 1904	NA	NA	NA	NA	NA	NA	NA	Kang et al. (2004) ‡
<i>Ostrea conchaphila</i> ‡	Carpenter, 1857	NA	NA	NA	NA	NA	NA	NA	Jozefowicz and Ó Foighil (1998)‡
<i>Ostrea denselamellosa</i> ‡	Lischke, 1869	NA	NA	NA	NA	NA	NA	NA	Jozefowicz and Ó Foighil (1998)‡
<i>Ostrea edulis</i> ‡	Linnaeus, 1758	13–20.6	5.5–18§	6–14§	114–150§	160–200§	270–320§	0.09–1.8§	Suquet et al. (2018)†, Jozefowicz and Ó Foighil (1998)‡, Spärck (1925)§, Erdmann (1935), Loosanoff and Davis (1963), Walne (1974), Carbonnier et al. (1990), Martin et al. (1997)
<i>Ostrea lurida</i> §	Carpenter, 1864	55	10	7–23	100–110	165–189	250–325	0.215–0.3	Suquet et al. (2018)†, Castanos et al. (2005)‡
<i>Ostrea permollis</i> ‡	Sowerby II, 1871	NA	7–9	30–33	60–80§	107–127	290	0.221	Jozefowicz and Ó Foighil (1998)‡, Buroker (1985)§
<i>Ostrea puelchana</i> §	d'Orbigny, 1842	20	5–7	17–20	60–90	110–130	284	1.9	Suquet et al. (2018)†, Jozefowicz and Ó Foighil (1998)‡
<i>Ostrea stentina</i> ‡	Payraudeau, 1826	3.1–13.3	NA	10–30	NA	123–140	270–320	NA	Jozefowicz and Ó Foighil (1998)‡

No life cycle data were found for the following species: *Ostrea angelica* Rochebrune, 1895, *Ostrea atherstonei* Newton, 1913, *Ostrea futamiensis* Seki, 1929, *Ostrea libella* Weisbord, 1964, *Ostrea megodon* Hanley, 1846. NA are data not available.

†Existing data on spermcasting.

‡Existing data on brooding.

§Updated data.

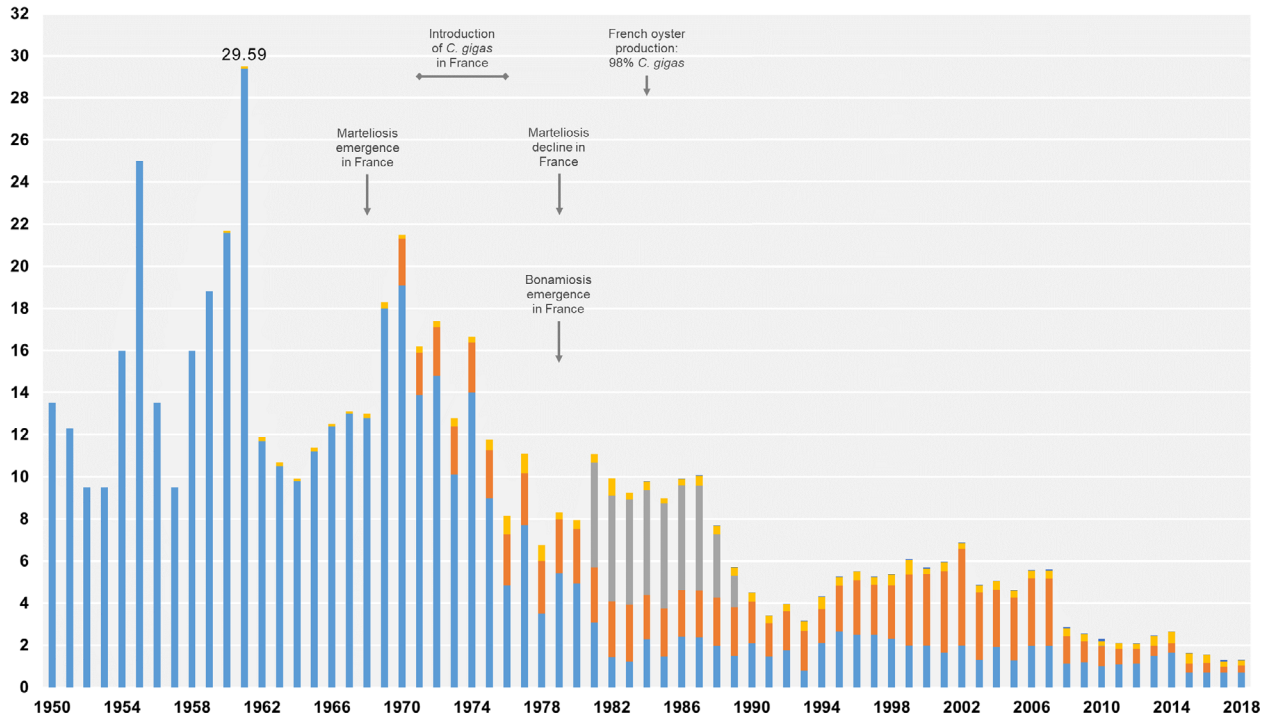

**Figure 1** Histogram of *Ostrea edulis* aquaculture production in Europe from 1950 to 2018 (FAO 2020) with some key French events (Héral 1990; Grizel & Héral 1991). The data include only the values corresponding to the European flat oysters; the volumes are in live weight and cumulated by country, independently of the main FAO production areas. (■) Other European countries: Bosnia-Herzegovina, Channel Islands, Croatia, Greece, Montenegro, Morocco, Norway, Portugal, SFR of Yugoslavia, Sweden, The Netherlands, Tunisia, UK; (■) Ireland; (■) Italy (1981–1989; 2010–2011); (■) Spain and (■) France.

can occur during the same breeding season (Marteil 1976). The tendency to protandria (i.e. the initial adult phase is male) is common and the formation of male gametes occurs in the post-settlement autumn (Davaine 1853; Cole 1942). This phase is not functional, and gametes are often lysed (Martin *et al.* 1997). The oyster then enters the female phase for the beginning of the following season. The occurrence of embryos has been observed already in one-year-old oysters (see Section Fertility). Information on the viability and survival of these embryos is scarce; however, Merk *et al.* (2020) reports a development of veliger larvae in these young oysters.

The sex change is much faster in the female-male direction, performed within days under optimal conditions (Yonge 1960). This rapid change, and gonads not emptying completely when male gametes are released, may result in the presence of both types of gametes within one oyster (Martin *et al.* 1997). Male and female gametes are present in the oyster follicles at the same time but with different stages of maturation (Maneiro *et al.* 2017b).

The occurrence of sexual inversion depends on several factors such as latitude, temperature and nutrition (Marteil 1976; Martin *et al.* 1997; Eagling *et al.* 2018): optimal

nutrition may increase the number of female spawners (Orton 1927).

The number of sex changes can vary between locations: once per season in Scandinavia (Yonge 1960), two to three times in the UK (Walne 1974) and more than three times in France (Martin *et al.* 1997). The determinism of sex change may also be influenced by internal factors such as the action of nerve nodes (Martin *et al.* 1997), but so far, no studies on neuroendocrine reproductive control are available for *O. edulis*.

A balanced sex ratio of the spawning population is relevant for successful reproduction in the field (Kamphausen *et al.* 2011; Zapata-Restrepo *et al.* 2019). Monitoring, and, if possible, management of the sex ratio is essential for the optimization of larval production in the hatchery. *Ostrea edulis* anaesthesia and *in vivo* magnetic resonance imaging, monitoring the sex ratio and gametogenesis, developed by Culloty and Mulcahy (1992), Davenel *et al.* (2010) and Suquet *et al.* (2010) provide non-invasive alternatives.

### Gametogenesis

It is hypothesized that *O. edulis* enters a winter sexual rest period which length can vary with latitudes (e.g. Norway,

the Netherlands, France, Croatia). Temperature and food availability play a predominant role for the initiation and progress of gametogenesis (Martin *et al.* 1997). Cole (1942) in Wales and Marteil (1976) in France define the onset of gametogenesis at around 10°C, while Wilson and Simons (1985) in Ireland observed the beginning of gamete redevelopment at a mean temperature above 7°C, but none of the identified studies report a geographical comparison.

Other parameters such as food, oyster age, size, salinity and the length of the photoperiod also seem to affect gametogenesis (Mann 1979; Cano *et al.* 1997; Joyce *et al.* 2013).

Nutrition and food availability is equally important during the winter phase as it is during the entire gametogenesis process. In winter, energy reserves might be stored and mobilized in springtime for gamete production (Gérard *et al.* 1997). On the other hand, Ruiz *et al.* 1992 report that *O. edulis* is in San Cibrán (Spain) an opportunistic organism that concentrates its breeding efforts on a short period of favourable conditions which depends directly on the availability of nutrients in the environment.

As previously mentioned in 3.3, the physiological state of the oysters (age and size) can vary according to different factors such as latitude and therefore influence the gametogenesis, which has an impact on the fertility rate.

The influence of salinity, however, is still under debate. Problems in resuming gametogenesis for salinities close to 20 have been observed in an estuarine area (Gérard *et al.* 1997) and beyond 20 and up to 36 (under the species' usual living conditions), no influence is assumed (Martin *et al.* 1997).

As daylight has also been shown to have a profound influence on other mollusc species, the positive effect of a prolonged photoperiod on the gonadal development (also called sexual glands, gonadal glands or gonads) of *O. edulis* during autumn and winter conditioning (light intensity reflecting the spring conditions in the environment) was shown in experimental hatchery conditions (Maneiro *et al.* 2016; Maneiro *et al.* 2017b).

An assessment of the maturity of gonadal development can be carried out following macroscopic criteria. A practical scale for the evaluation of the stages within the sexual cycle of *O. edulis* was established by Marteil (1959), see Table 3. As mentioned above in chapter 3.3, other methods (anaesthesia, *in vivo* magnetic resonance imaging, histology) and protocols exist for determining maturation. As an example, Maneiro *et al.* 2016 describe a method for the determination of gonadal development using histology and stereology techniques.

## Spawning and fertility

### Spawning

The minimum gamete emission (i.e. release of eggs into the pallial cavity of females and release of spermatozeugmata

from the male oyster) temperature has been extensively studied and varies according to regions and geographical conditions (Table 4). Depending on latitude, the minimum critical temperature is between 14 and 16°C (Marteil 1976). However, spawning events of the northern population are observed at 25°C in breed polls, while populations in Spain and the Adriatic Sea start spawning (or can spawn) at 12–13°C (Bromley *et al.* 2016a).

Different stimuli induce spawning in mature oysters: presence of gametes (Gendreau 1988; Chapter 7.4.4), sudden changes in temperature and salinity (Marteil 1976) or a change in temperature combined with wave and current actions (Lubet 1991). Lunar cycles have been argued/demonstrated to affect gamete release by Orton (1927), Korringa (1940), Walne (1974) and Martin *et al.* (1997), but may also be an effect of other factors correlated to such cycles, for example tidal ranges/coefficients (Lubet 1991).

The reproductive strategy of *O. edulis* females is internal brooding (Figure 2). By keeping the offspring inside the female's mantle cavity, embryos are protected from external conditions (Mardones-Toledo *et al.* 2015). In the male phase, *O. edulis* performs sperm casting, where functional males release spermatozeugmata, clusters composed of a central nucleus: spermatozoa are fixed by the head and the flagella radiates freely (Hassan *et al.* 2017; Suquet *et al.*

**Table 3** Practical scale for evaluating the stages of the sexual cycle in *Ostrea edulis* modified and translated into English (modified after Marteil (1959) and Martin *et al.* (1997))

Stage	Description	Term
5-0	Empty gonad – corresponds to sexual rest or the end of the expulsion of gametes or larvae	Very thin or thin oysters
1	Beginning of gametogenesis: multiplication of germ cells	Low greasy oysters
2	Gonads well developed but gamete dissociation remains difficult	Greasy oysters
3	Maximum response: gone hypertrophied, a thick white-cream layer envelops the visceral mass, abundant gametes are obtained by very light pressure	Very greasy oysters
4	Gamete emission – incubation in females	Spawning/brooding
4a	The eggs have just been emitted and form a milky white mass in the pallial cavity	Milky (white-sick oysters)
4b	End of incubation: the larval shells give the mass of the embryos a greyish-slate colour	Slate colour (grey/black-sick) oysters (colour evolution: from gray to faint blue, and then black)
5	Completely empty gonad: clearly visible digestive mass, greyish colour of the flesh	Confused with stage 0/spent gonad



**Table 4** Onset spawning temperature of *Ostrea edulis* (modified after Bromley *et al.* (2016a))

Temperature (°C)	Country	Location	Reference
25	Norway	Bergen	Bromley <i>et al.</i> (2016a)
20.5	England	NA	Bayne (2017)
18–22	Israel	Eilat	Shpigel (1989)
20	Denmark	Limfjord	Bromley <i>et al.</i> (2016a)
18	Canada	Lockhart Lake	Bromley <i>et al.</i> (2016a)
16	Wales	Conwy, Conwy	Walne (1974)
15	The Netherlands	Oosterschelde	Bromley <i>et al.</i> (2016a)
15	England	Crouch, Essex	Bromley <i>et al.</i> (2016a)
15	England	Fal, Cornwall	Bromley <i>et al.</i> (2016a)
15	France	Morbihan	Bromley <i>et al.</i> (2016a)
15	France	Arcachon	Bromley <i>et al.</i> (2016a)
15	Italy	Lago Fusaro	Carlucci <i>et al.</i> (2010)
15	Italy	Mare Grande Tarante	Carlucci <i>et al.</i> (2010)
14	Croatia	Mali Ston Bay	Bratoš <i>et al.</i> (2002)
14	Spain	Mar Menor	Cano <i>et al.</i> (1997)
13	South Africa	NA	Bayne (2017)
13	Ireland	Lough Foyle	Bromley <i>et al.</i> (2016a)
13	Italy	Adriatic	Carlucci <i>et al.</i> (2010)
12	Spain	Vigo	Bromley <i>et al.</i> (2016a)

2018). Spermatozeugmata have a mean diameter of  $64 \pm 3 \mu\text{m}$ , and spermatozoa are released in  $21 \pm 3 \text{ min}$ . The mean curvilinear velocity of spermatozoa movement is  $68.5 \pm 8.7 \mu\text{m s}^{-1}$  (Suquet *et al.* 2018).

Male oysters are generally more sensitive to stimulation and emit their gametes first (usually in one event, but possibly incomplete, successive or extended in time). These first spawnings then lead to the spawning of adjacent males and, subsequently, to the spawning of females (His *et al.* 1999). Nelson and Allison (1940) extracted a substance called 'diantline' from oyster sperm which causes, among other things, the relaxation of smooth muscles in female oysters, thus promoting the release of eggs (Martin *et al.* 1997) through the gills into the pallial cavity (Yonge 1960), where they are fertilized by spermatozoa from spermatozeugmata inhaled by the female (His *et al.* 1999).

The number of spawning events per year, the intensity of spawning and the spawning period vary with geographical regions and climatic conditions (Korringa 1940): In Scandinavia, the breeding period is short with only one spawning per year (Yonge 1960). If conditions interfere with the development of gametogenesis and spawning, reproduction will be impaired or natural recruitment will be negligible (Martin *et al.* 1997).

### Fertility

The term fecundity and fertility are often confused in the literature for *O. edulis*. According to the definition of Allee

*et al.* (1949) which Walne (1964) follows, the term fecundity refers to the production of male and female gametes, while the term fertility refers to the production of embryos and larvae.

The fertility rate of *O. edulis* varies between oyster age, studies and authors (Table 5). The different numbers may be explained by different abiotic factors, such as temperature during gametogenesis (Martin *et al.* 1997). As *O. edulis* can live up to 14 years (Richardson *et al.* 1993), data on both fecundity and fertility rate of the 7- to 14-year-old specimens would be of great importance for predicting population dynamics, but so far do not exist in the reviewed literature.

## Incubation and swarming

### Incubation phase

Literature on embryo development and early larval stages is scarce. The bibliographic search revealed only Davaine (1853), Horst, (1884), Fernando and MacBride (1931) and Gendreau (1988). The different stages are schematised in Figure 2. Dantan and Perrier (1913) report that during the developmental phase between embryo and larva, there appears to be little or no mortality. For the purpose of artificial breeding trials, Gendreau (1988) describes the ex vivo development of embryos and larvae, summarized in Box 1 and Figure 2. This information may serve as a basis for the development of artificial reproduction techniques for *O. edulis*.

### Box 1. Kinetics of ex vivo development of embryos and early larval stages at 20°C (Gendreau 1988)

15–20 min after fertilization the oocytes increase in volume. The first polar globules appear around 30 min and the second around 85 min after fertilization. The subsequent development asynchronism is reported to be observable at each stage. The polar lobes appear around 210 min after fertilization and remain observable for 2 h and 30 min. The two-cell stage is observed for 2 h and 40 min, starting from 270 min after fertilization. After 6 h, the four-cell stage is observable for 4 h. Beyond that, the superposition of the increasing number of cells makes it difficult to distinguish the different developmental kinetics. The embryos pass through the stages of morula, blastula and gastrula to become young trochophore larvae within the first 24 h. The trochophore larvae carry a prototroch that allows them to be mobile, however without being able to swim freely. During the next 24 h, the ciliature extends into a crown. On days three and four, the larvae carrying a velum begin to swim.

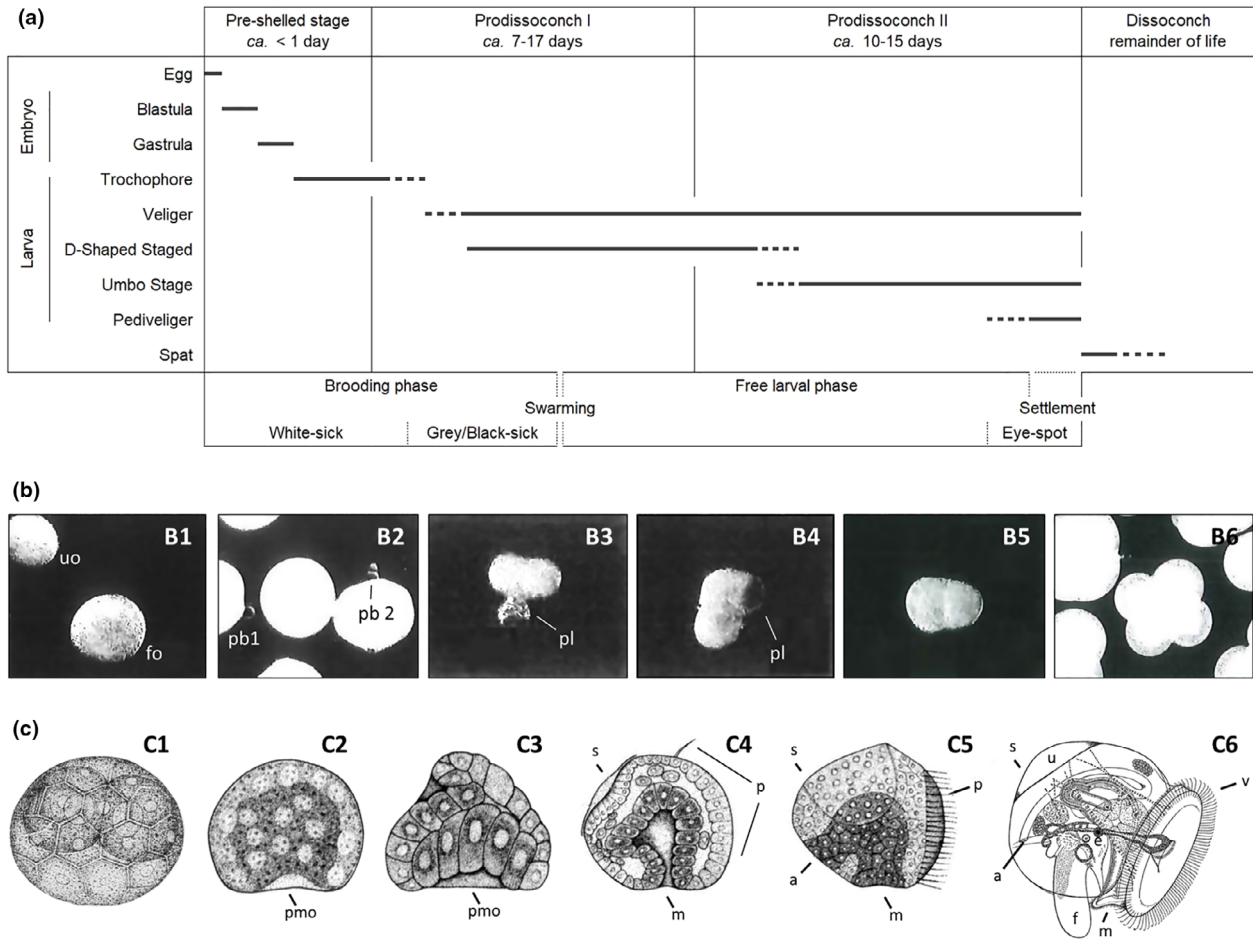

**Figure 2** (a) Development of the prodissoconch in relation to other common terms describing larval shell, body and development stages of *Ostrea edulis*. Dashed lines indicate uncertainty or transition. The duration of stages may be highly variable. Modified after Waller (1981). (b) Embryonic development of *O. edulis*: (b1) Fertilized oocytes (fo), Unfertilized oocytes (uo); (b2) Polar body I (pb1), Polar body II (pb2); (b3) Polar lobe (pl) appearance; (b4) Polar lobe (pl) resorption; (b5) Two-cells stage; (b6) Four-cells stage. Photographs and descriptions modified after Gendreau (1988). (c) Early development schemes of *O. edulis*: (c1) Morula/Blastula stage; (c2) Gastrula stage; (c3) Early trochophore; (c4) Middle trochophore; (c5) Late trochophore; (c6) Fully developed larva. (pmo) Presumptive mouth opening; (m) Mouth; (s) shell; (p) Prototroch; (a) Anus; (v) Velum; (u) Umbo; (e) Eye spot; (f) Foot. (c1–c5) Modified after Horst (1884) and Waller (1981), (c6) Modified after Erdmann (1935) and Yonge (1960). As an additional information, the development stages (b1–c4) correspond to the white-sick stage; the grey-sick stage is only represented here in (c5); the black-sick stage is not represented here.

It is suggested that dead larvae are detected by brooding oysters (*O. chilensis*) and ejected from the pallial cavity with pseudofaeces (Chaparro *et al.* 2018). Females may reject some of their own viable veliger along with dead larvae. This was observed in *O. edulis* (Gray *et al.* 2019) although according to Walne (1974), there is very little or no loss of larvae during the incubation period. The brooding period lasts 7–10 days (Orton 1936). At 15–16°C, the white-sick stage is therefore reached after about 3.25 days of incubation, the grey-sick stage is reached 1.75 days later and the black-sick stage within four more days. Spärck (1925) states a different timeline for the larval

development: the black-sick stage is reached after 3.5 days and, depending on the temperature, it takes 5.5 additional days at 15°C or 2.0 days at 19°C until swarming. At 13.5, 17.5 and 23°C, the length of the incubation period varies among 18, 14 and 7 days, respectively, Erdmann (1935). At low temperatures, Erdmann (1935) observed a delay in swarming and larger dimensions of swarming larvae as well as advanced larval developmental stages.

#### Swarming

After the development of the larvae during internal brooding, swarming (i.e. release of the larvae from the female

**Table 5** The fertility of *Ostrea edulis* related to the age and the size of the brooding oyster: summary of the data found in the literature

Fertility per oyster (embryos-larvae $\times 10^6$ )	Mean diameter of oysters (mm)	Approximative age of oysters (years)	Reference
0.0916	38	1	Cole (1941)
0.1000	34	1	Dantan and Perrier (1913)
0.1000	40	1	Walne (1974)
0.1000	NA	1	Gaarder and Bjerkan (1934)
0.2180	NA	2	Cole (1941)
0.2400	NA	1	Orton (1937)
0.2470	NA	2	Dantan and Perrier (1913)
0.2500	NA	2	Gaarder and Bjerkan (1934)
0.4626	60	3	Cole (1941)
0.5250	NA	3–4	Orton (1937)
0.5400	57	2	Walne (1974)
0.7304	NA	3	Dantan and Perrier (1913)
0.8000	NA	3	Gaarder and Bjerkan (1934)
0.2765–0.8296	NA	NA	Philpots (1890)
0.8400	70	3	Walne (1974)
0.9029	70	4	Cole (1941)
1.0000	NA	>3	Gaarder and Bjerkan (1934)
1.0129	Very large oysters	NA	Möbius (1883)
0.8000–1.1000	75	NA	Utting <i>et al.</i> (1991)
1.1000	79	4	Walne (1974)
1.2600	84	5	Walne (1974)
1.3600	87	6	Walne (1974)
1.5000	90	7	Walne (1974)
1.8000	Very large oysters	NA	Eyton (1858)

oyster in the wild) is induced by strong contractions of the adductor muscle and the opening of the shell resulting in the ejection of the veliger larvae in clouds (Erdmann 1935). This action is repeated several times with short and long intervals, the whole swarming can be completed within a few hours (Korringa 1940).

Regarding the swarming periodicity of *O. edulis*, Korringa (1940) summarized that: (i) temperature is not the only factor in the process of larval release; (ii) slight differences in salinity seem to be irrelevant; (iii) swarming takes place on both clear and rainy days, which indicates that there is no influence of wind; (iv) swarming depends directly on the frequency of spawning and the duration of incubation (as mentioned above).

## Post-swarming larval stages

### Larval development and survival

Larval size during swarming depends on the incubation conditions and therefore indirectly on the latitude and the related environmental parameters, ranging from 160 to 200  $\mu\text{m}$  when released into the water (Table 2).

Erdmann (1935), Yonge (1960) and Waller (1981) offer exhaustive descriptions of larval development of *O. edulis*. A short synthesis of larval sizes and developmental stages is available in Acarli and Lok (2009).

The influence of salinity and temperature on larval survival was examined in the laboratory (Davis & Ansell 1962), Davis & Calabrese 1969): At a salinity of 10, larvae die within days, at 12, larvae do not grow and 10 days post-swarming, mortality rate is > 90%. Larvae reared at salinities between 15 and 17.5 grow, but die before metamorphosis, at 20, growth is moderate without mortality. *Ostrea edulis* larvae show high growth and settlement rates at salinities > 22.5 and are able to settle at salinities as low as 15. Temperature should range between 17.5 and 30°C (growth) or between 12.5 and 27.5°C (survival). Below 10 and above 30°C, survival rates are low.

Another relevant parameter is hydrogen sulphide and its impact on *O. edulis* larvae. However, this does not seem to be described in the literature, despite recurrent problems in the natural environment and in breed polls (Korringa 1940; Yonge 1960). Data are available from Theede *et al.* (1969) on adult *O. edulis* in the Black Sea and states a survival of 5 days at hydrogen sulphide concentrations between 0 and 5.6  $\text{cm}^3 \text{L}^{-1}$  seawater; however, the tolerance to abiotic conditions between adult and larve cannot be compared.

The larval survival rate in the natural environment is related to multiple parameters (Fig. 3) such as food abundance, predation and sediment movements and is not described in full detail here. Diseases, pathogens, contaminants and predators will be discussed in chapters 5.1–5.3.

### Pelagic larval period

The planktrophic pelagic larval life of *O. edulis* in the natural environment appears to be directly related to temperature. According to Korringa (1940), this phase lasts 6–7 days at a temperature of 22°C, or 12 days at 18°C. Further, for Marteil (1976) and Buroker (1985), it can extend from 6 to 14 days for temperatures ranging from 18 to 20°C.

### Larval behaviour

Information on the behaviour of *O. edulis* larvae is available for veliger larvae (Erdmann 1935), for settlement behaviour (Cole & Knight-Jones 1949; Rodriguez-Perez *et al.* 2019), for swimming behaviour and pressure responses (Cragg & Gruffydd 1975), and for free swimming searching

behaviour, crawling behaviour and cementing, including an estimation of the maximum larval swimming speed of 500 mm h<sup>-1</sup> and other locomotion characteristics (Cranfield 1973).

The settlement of *O. edulis* is influenced by many factors such as larval quality, hydrodynamic conditions or the physico-chemical quality of the seawater. The parameters light, temperature, biofilm and collector type or substrate are briefly described here:

According to Cole and Knight-Jones (1949), Bracke and Polk (1969) and Walne (1974), the influence of light changes during the larval cycle. Larvae show negative phototropism at settlement stage (Bracke & Polk 1969) and preferences for dark collectors (Cole & Knight-Jones 1949). Walne (1974) highlights the nycthemeral preference of larvae to settle during daytimes: intense illumination at the end of the larval breeding period could promote both the speed and the intensity of the settlement. Thus, negative phototropism seems to characterize larvae at the beginning of metamorphosis and light could therefore act as a catalyst for settlement (Carbonnier *et al.* 1990).

Marteil (1976) summarizes that warmer temperatures reduce pelagic life span and potentially increase larval survival rate. In addition, an increase in temperature at the time of metamorphosis could favour the fixation of larvae (Carbonnier *et al.* 1990). Furthermore, Nielsen and Petersen (2019) report that the success of spawning and spat fall of flat oysters in the Limfjorden in Denmark is directly related to the summer temperature.

The biological film, which is built up on substrates or collectors, also plays an important role in the settlement of *O. edulis* larvae (Walne 1958). It is indicated that in aquaculture, a 2–3 week soaking of the collectors can increase the settlement rate. The bacterial film produced by *Shewanella colwelliana* induced settlement of *O. edulis* in hatchery (Tritar *et al.* 1992). Further studies highlight the role of biofilm for inducing settlement (Rodriguez-Perez *et al.* 2019), but so far, this subject has been rarely studied.

Within the natural tolerance range of the species, salinity has practically no impact on larval development (Marteil 1976). Variations in salinity nevertheless can induce settlement if they are confined and a gradual return to the initial salinity is ensured (Carbonnier *et al.* 1990).

Other parameters and mechanisms influencing settlement are developed in various studies: pH (Cole & Knight Jones 1949; Carbonnier *et al.* 1990), substrate type and composition (Cole & Knight Jones 1949; Korringa 1976; Guesdon *et al.* 1989), orientation angles and shape of the substrate (Cole & Knight Jones 1949; Korringa 1976; Col-soul *et al.* 2020), colour and transparency of the substrate (Herman 1937; Cole & Knight Jones 1949; Walne 1974), presence of conspecifics or other species (Cole & Knight Jones 1949; Rodriguez-Perez *et al.* 2019).

## Oyster nutrition

Oysters show two strategies of food uptake: either directly absorbing dissolved substances from the seawater or ingesting suspended particles (Héral 1990).

Rice *et al.* (1980) demonstrated the direct absorption of dissolved organic matter by the net uptake of amino acids from seawater by *O. edulis* larvae. Laboratory experiments indicate that lipids in solution can be absorbed rapidly by juveniles and pediveligers of Pacific oysters (*C. gigas*; Fankboner & De Burgh 1978). In addition, Bamford and Gingles (1974) highlighted the absorption of glucose in the gills of adult oysters (*C. gigas*). Furthermore, mussel embryos (*Mytilus edulis*) and larvae are capable of absorbing dissolved organic substances; however, there is no evidence that larvae are able to grow and develop only by feeding on dissolved organic matter (Widdows 1991).

The ingestion of suspended particles by adult *O. edulis* includes both mineral and organic particles which are filtered and retained on the surface of the gills and surrounded by mucus (Héral 1990). The food is then sorted, ingested and partly digested. The remaining material passes through the intestine and is evacuated through the anus as faeces. If particulate matter is too abundant or too large it is directly ejected by the gills and labial palps or bound together by mucus, dropped into the mantle and ejected as pseudofaeces. Particle size ingested by *O. edulis* ranges from micro- and nanoplankton down to picoplankton (ca. 200–0.2 µm; Cole 1937; Cano *et al.* 1997; Marshall *et al.* 2010). Groups of bacteria, fungi and tripton (non-living particulate matter) are also consumed (Martin *et al.* 1997).

According to the bibliographical search, the feeding of adult *O. edulis* and larvae on bacteria has never been tested extensively.

## Stressors

### Oyster diseases and pathogens

Pathogens, such as bacteria, copepods, fungi, microalgae, polychaetes, protozoa, sponges and viruses, can induce diseases, mortalities or significant malformations in *O. edulis*, (Table 6; Chapter 4.1.1–4.1.4). High mortalities occur in the past, and their causes were not always discovered. Orton (1937) reports three examples of high mortality from unknown causes: in 1877 in France (Arcachon), in 1895 in the Netherlands and in 1098 in Norway.

A massive mortality event of (adult) *O. edulis* following establishment of commercial culture in Europe (England, Wales, the Netherlands, France and Italy) appeared in 1920 (Orton 1937; Grizel 1985; Héral 1990). The exact cause of these deaths was unclear, but disease, possibly an infection by a protozoan and unusual temperatures are assumed (Marteil 1976; Grizel 1985).

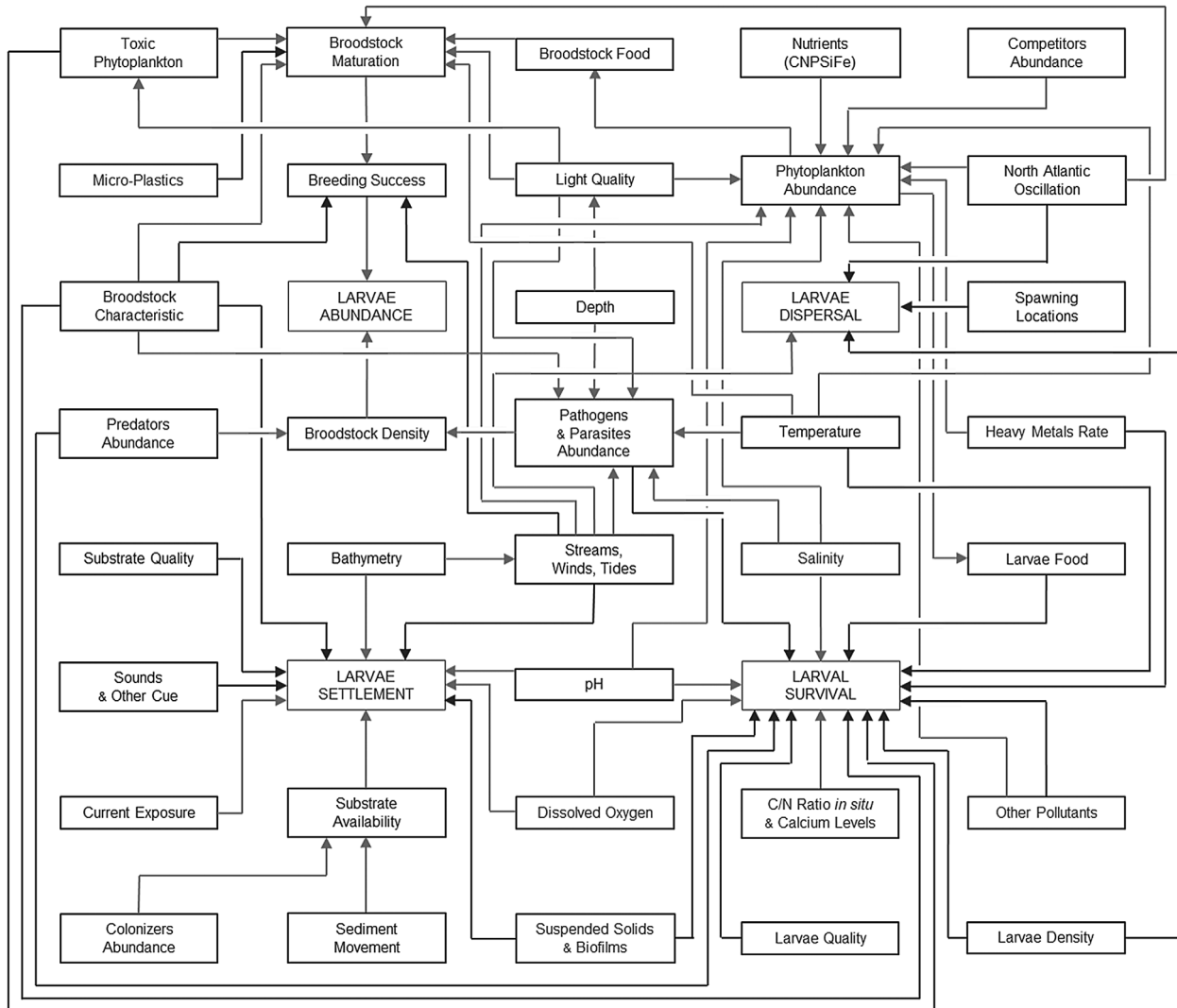

**Figure 3** Drivers of spat recruitment intensity: conceptual diagram of the four main parameters and their associated potential factors (biological, chemical, physical).

The two major known diseases of adult *O. edulis* are Marteliosis and Bonamiosis, and these are described below.

#### Marteliosis

Another massive mortality event in Europe was reported on *O. edulis* as ‘Abers disease’ in the literature and was caused by the protozoan *Marteilia refringens*. From 1968 onwards, this protist spread to the majority of Breton farms (France) and was responsible of the marteliosis disease (Héral 1990). From 1974 onwards, it then further induced massive mortalities at production centres all over France. The spread of the disease across Europe is not documented, but *M. refringens* can be found (either in *O. edulis* or in other bivalves) in Albania, Croatia, France, Greece, Italy, Morocco, Portugal, Slovenia, Spain, Sweden, Tunisia and

the UK among others (Carrasco *et al.* 2015). *Marteilia refringens* was detected in Dutch flat oyster stocks in the period 1974–1977 (van Banning 1979b), but not recorded any more in yearly surveys since 1978 (Haenen & Engelsma 2020). Mortality mostly affects two-year-old oysters and can reach up to 90% mortality among oysters (Carrasco *et al.* 2015; Anonymous 2018). For all characteristics of *O. edulis* diseases, see Table 6.

#### Bonamiosis

Immediately after the decline of marteliosis in France in 1979, bonamiosis appeared. This infection by the haplosporidian *Bonamia ostreae* induced what is commonly referred to as the third wave of large-scale *O. edulis* mortality in Europe. This led to a partial abandonment of the

cultivation of *O. edulis* in favour of other species of commercial interest such as *C. gigas*. The parasite was reportedly introduced into Europe (France and Spain) following movements of oysters from the USA (Friedman & Perkins 1994; Bromley *et al.* 2016a). First detected in France in 1979, bonamiosis rapidly spread all over Europe: the Netherlands, Spain and Denmark in 1980, England in 1982, Ireland in 1987 and since then continued to spread to other European countries including Italy, Wales, Northern Ireland, the Netherlands, but also outside Europe to Canada and Morocco (van Banning 1987; Culloty & Mulcahy 2007). More recently, *B. ostreae* has been detected in New Zealand in *O. chilensis* (Lane *et al.* 2016). This parasite particularly affects the older oysters and causes a mortality of 50–80% of the stock while infection rate is lower in young oysters (Grizel 1985; Héral 1990).

*Ostrea edulis* can be infected by *B. ostreae* from the larval stage onwards (Arzul *et al.* 2011). Prevalence and pathogenic impact on *O. edulis* is eventually affected by water depth (Lama & Montes 1993). Oyster larvae are potentially acquiring the pathogen from the water column during filter feeding or from the pseudofaeces of a brooding adult (Flannery *et al.* 2016). Some populations show increased resistance indicating that genetic advantages against the infection exist and populations can potentially adapt and evolve resistance (Naciri-Graven *et al.* 1998; Lynch *et al.* 2005; Vera *et al.* 2019).

The fast spread and high virulence of these pathogens highlight the need of taking precautions when translocating oysters to cultivation, breeding or ecological restoration sites (Sas *et al.* 2020).

#### Shell drillers

Concerning shell-boring parasites, it is worth mentioning polychaetes and sponges. Within the group of shell-boring polychaetes having *O. edulis* as host, different species of the genus *Polydora* and the genus *Boccardia* exist (Lauckner 1983; Robert *et al.* 1991). For shell-boring sponges with *O. edulis* as host, species of the genus *Cliona* are prevalent, with in particular *Cliona celata* (Hoeksema 1983) and *Cliona viridis* (Rosell *et al.* 1999) in Europe. In the literature selected in this review, no data were found on the impact of the above-mentioned parasites on growth, weight gain or mortality of *O. edulis*.

#### Specific larval diseases

As Orton (1937) quotes, and important to underline, by far the greatest mortality for *O. edulis* occurs in the larval stage, whether in the natural environment, or in production.

The diseases occurring in hatcheries are mostly caused by bacteria and not by protozoans (Helm *et al.* 2004). Bacteria can originate from the non-treated broodstock, the algal

and the larval cultures. Bacteria that cause large-scale mortalities mostly belong to the genus *Vibrio* sp. and can trigger severe epizootics in hatcheries.

*Vibrio* spp. are ubiquitous in the marine environment and their genetic as well as their ecological variability led to the emergence of several diseases in oyster aquaculture (Mardones-Toledo *et al.* 2015; Travers *et al.* 2015). Accordingly, many strains can have pathogenic potential (Wendling *et al.* 2014). Virulence however can vary between host populations and environments (Wendling & Wegner 2015; Wendling *et al.* 2017), making specific predictions and effects on wild populations difficult.

A list of bacteria of the genus *Vibrio* affecting *O. edulis* larvae is presented in Table 6.

#### Pollutants

The term pollutant is applied here in the sense of contaminants. The first pollution problems for bivalve populations appeared in the beginning of the 20th century (His *et al.* 1999). Prytherch (1924) seems to be the first to state that pollution is one of the main factors in the decline of oyster beds. The toxicity of these contaminants can have physiological and morphological impacts on adult oysters but can also affect eggs, embryos and larvae. Heavy metals can affect embryogenesis, larval growth, larval survival, settlement, respiration and in some cases chromosomes (His *et al.* 1999).

Zinc and Chlorine are two components that could be found in a hatchery: the first in the water (inlet), the second in the discharge water (outlet). Zinc concentrations of 100–500  $\mu\text{g L}^{-1}$  cause reduced growth, increased incidence of abnormal development and increased mortality of *O. edulis* larvae (Calabrese *et al.* 1977). Chlorine concentrations up to a level of 10 000  $\mu\text{g L}^{-1}$  do not affect *O. edulis* larvae. At a concentration of 20 000  $\mu\text{g L}^{-1}$ , a significant proportion of larvae is still able to survive and grow. However, for chlorine concentrations between 50 000 and 200 000  $\mu\text{g L}^{-1}$ , larval survival and growth are low (Waugh 1964).

Literature data on the impact of several heavy metals and detergents on growth, mortality and settlement rate of *O. edulis* larvae are provided in Table 7. A relatively new pollutant in the environment is microplastics which adsorbs different pollutants from the environment allowing them to enter the mantle cavity of the filter feeding oysters. However, the effects of microplastics on the respiration rate, the filtration rate and the growth rate of adult *O. edulis* are minimal (Green 2016), whereas no data on the general health status and potential long-term effects exist so far. Further research on nanoplastics is to be expected, as we know for *C. gigas*, nanoplastics can affect

**Table 6** List of internal pathogens and parasites of *Ostrea edulis* having a potential impact on its host and offspring (modified after Anonymous (2018))

Group	Species	Descriptor	Size (µm)	Host impact	Geographical distribution	Infection period	Diagnostic	Transmission	References§
Algae	<i>Gyrodinium aureolum</i> ‡	Hulburt 1957	13–36	Necrosis of the central area of the digestive gland	(Laboratory test)	No specific period	Gross observation‡	NA	Partensky and Vault (1989), Smolowitz and Shumway (1997)
Bacteria	<i>Nocardia crassostreae</i> ‡	Friedman et al. 1998	NA	Adult oyster Mortality (can be present in every tissue)	Canada, Europe (The Netherlands)	Late summer and fall	Tissue imprint Histology PCR	Direct	Engelsma et al. (2008)
Bacteria	<i>Vibrio alginolyticus</i>	Miyamoto et al. 1961	NA	High larval mortality (challenged with pathogen: up to 100%) Larval mortalities	(Laboratory test)	No specific period	ISH PCR	Direct	Tubiash et al. (1965)
Bacteria	<i>Vibrio anguillarum</i> ‡	Bergeman 1909	NA	Larval mortalities	Europe (Spain‡)	No specific period	PCR	Direct	Lodeiros et al. (1987)
Bacteria	<i>Vibrio coralliilyticus</i>	Ben-Haim et al. 2003	NA	Larval Mortalities	USA, New Zealand, Europe (France)	No specific period	PCR	Direct	Dubert et al. (2017)
Bacteria	<i>Vibrio neptunius</i>	Thompson et al. 2003	NA	High larval mortalities (>98%)	Europe (Spain)	No specific period	PCR	Direct	Prado et al. (2005), Dubert et al. (2017)
Bacteria	<i>Vibrio ostreicida</i>	Prado et al. 2014	NA	High larval mortalities (86.4–98.5%)	Europe (Spain)	No specific period	PCR	Direct	Dubert et al. (2017)
Bacteria	<i>Vibrio tubiashii</i> ‡	Hada et al. 1984	NA	Larval mortalities (lethal exotoxins (to larvae), bacillary necrosis)	USA, Europe (Spain‡)	Infect the larvae during the brooding period	PCR	Direct	Lodeiros et al. (1987)
Copepod	<i>Herrmannella duggani</i> ‡	Holmes et al. 1991	490–1560	Reduce gills size (present in the shell cavity)	Europe (Ireland)	Uncertain	Gross observation‡ Histology‡	Direct	Holmes and Minchin (1991)
Copepod	<i>Mytilicola intestinalis</i>	Steuer 1902	>1000	Minimal impact on host (present in the gut lumen)	USA, Japan, Europe	Uncertain	Gross observation Histology	Direct	Hepper (1956)

Table 6 (continued)

Group	Species	Descriptor	Size (µm)	Host impact	Geographical distribution	Infection period	Diagnostic	Transmission	References§
Fungus	<i>Ostracoblabe implexa</i>	Born et al.	1.5–2.5	Shell abnormalities	India, Canada (Nova Scotia), Europe (UK, France, the Netherlands)	Summer (temperature > 22°C)	Gross observation Histology	NA	Dollfus 1921, Orton, 1937, Li et al. (1983), Anonymous (2018)
Protozoan	<i>Bonamia exitiosa</i> †	Hine et al. 2001	3.0 ± 0.3	Oyster mortality in <i>O. chilensis edulis</i> (present in haemocytes; all tissues can be invaded)	Australia, New Zealand, Tasmania, Europe (Croatia, France, Italy, Portugal, Spain, Tunisia, UK)	Throughout the year (with a peak during Australian autumn)	Tissue imprint Histology PCR ISH Electron microscopy	NA	Abollo et al. (2008), Anonymous (2018), Helmer et al. (2020)
Protozoan	<i>Bonamia ostreae</i> †	Pichot et al. 1980	2–5; 2.4 ± 0.5 (mean diameter)	Oyster mortality (present in haemocytes; all tissues can be invaded; larvae can be infected)	USA, Europe (Belgium, Denmark, England, France, Italy, Morocco, Netherland, Northern Ireland, Spain, Wales), New Zealand	Throughout the year (with a peak in late winter-early spring). Incubation period: 3–4 month in infected area	Tissue imprint Histology PCR ISH Electron microscopy	Direct	Abollo et al. (2008), Arzul et al. (2009), Lane et al. (2016)
Protozoan	<i>Haplosporidium armoricanum</i>	Van Banning 1977	Sporont (length: 9.8 ± 2.5; width: 7.9 ± 1.9), Spore (length: 4.1 ± 0.4; width: 2.9 ± 0.3)	Occasional oyster mortality (present in the connective tissue)	Europe (France, Netherland, Spain)	Uncertain	Tissue imprint Histology	NA	van Banning (1977), Azevedo et al. (1999), Hine et al. (2007)
Protozoan	<i>Hexamita inflata</i>	Dujardin 1841	8–18	Shell disease and mortality (present in the blood stream)	USA, Canada, Europe	Uncertain	Gross observation‡	NA	Mackin et al. (1951), Khouw (1965), van Banning (1979a)



Table 6 (continued)

Group	Species	Descriptor	Size (µm)	Host impact	Geographical distribution	Infection period	Diagnostic	Transmission	References§
Protozoan	<i>Marteilia refringens</i> †	Grizel et al. 1974	7–35 (primary cell)	Oyster mortality (extracellular parasite of the digestive gland)	Europe (Albania, Croatia, France, Greece, Italy, Morocco, Portugal, Spain, Sweden, Tunisia, UK) USA, Canadian (west coast)	Spring-summer (temperature >17°C)	Tissue imprint Histology PCR ISH Electron microscopy	Intermediate host: copepod ( <i>Paracartia grani</i> )	Berthe et al. (2004), Virvilis and Angelidis (2006), López-Sanmartín et al. (2015)
Protozoan	<i>Mikrocystos mackini</i> †	Farley et al. 1988	ca. 2	Oyster mortality (intracellular parasite in the connective tissue cells)	USA, Canadian (west coast)	From winter to late spring. Incubation period: 3–4 month in infected area (temperature < 10°C)	Tissue imprint Histology PCR ISH Electron microscopy	Direct	Bower et al. (1997), Gagné et al. (2008)
Protozoan	<i>Perkinsus mediterraneus</i>	Casas et al. 2004	97.4–167	NA	Spain (Balearic Islands)	Late summer and autumn‡	Histology Electron microscopy	NA	Alderman and Gras (1969), Casas et al. (2004), Casas et al. (2008) Tige et al. (1977)
Protozoan	<i>Pseudoklossia</i> ( <i>Genus of</i> )	NA	ca. 10	Parasite present in the kidney‡	France	NA	Histology Electron microscopy	NA	
Unknown	Unknown (haemocytic neoplasia)‡	NA	NA	NA	France (Brittany)	NA	Histology Histocytology	NA	Balouet et al. (1986)

**Table 6 (continued)**

Group	Species	Descriptor	Size (µm)	Host impact	Geographical distribution	Infection period	Diagnostic	Transmission	References§
Virus	<i>Herpesviridae</i> (family of)	NA	Larvae: 0.118 ± 0.008 (herpes-like virus particles; enveloped virions)	Occasional larvae and juvenile mortality (present in the connective tissues)	USA, Australia, New Zealand, Europe	Summer (temperature > 19°C)	Histology PCR ISH Electron microscopy	Direct	Comps and Cochenec (1993), Renault et al. (2000), Renault and Arzul (2001), da Silva et al. (2008)
Virus	<i>Papovaviridae</i> (family of)	NA	NA	(Present in connective tissues; gametocytes)	USA, Australia, Korea, Japan, Europe (France)	NA	Histology Electron microscopy	Direct	Anonymous (2018)

ISH, *in situ* hybridization; NA, data not available; PCR, polymerase chain reaction.

†Exotic and non-exotic diseases to be immediately notified to the national competent authority in Europe by the annex IV, part II of the Council Directive 2006/88/EC of 24 October 2006 (Anonymous 2006a).

‡Assumption to be confirmed.

§Main references found in the literature search.

**Table 7** List of known pollutants and their effects on the mortality, growth and metamorphosis of larvae of *Ostrea edulis* (modified after His *et al.* (1999))

Pollutants	Initial age of exposed larvae	Exposure temperature (°C)	End-point	EC <sub>50</sub> /LC <sub>50</sub> (µg L <sup>-1</sup> )	Reference
Heavy metals					
Copper	48 h	NA	Mortality	1–3	Alzieu <i>et al.</i> (1980)
Mercury	1–3 days	4.2	Mortality	3.3 (µg metal ion L <sup>-1</sup> )	Connor (1972)
Zinc	96 h	NA	Growth (length)	100–500	Walne (1970)
Detergents					
Actusol	NA	NA	NA	20 000–40 000	His <i>et al.</i> (1999)
BP 1002	NA	NA	Growth (2 days)	2500–7500	His <i>et al.</i> (1999)
Corexit	NA	NA	NA	40 000–80 000	His <i>et al.</i> (1999)
Farrells	NA	NA	NA	6000–8000	His <i>et al.</i> (1999)
FO-300-B	NA	NA	NA	4000–8000	His <i>et al.</i> (1999)
Gamlen	1 week	23	Growth (2 days)	ca. 1000	His <i>et al.</i> (1999)
Houghtosol	1 week	23	Growth (2 days)	ca. 1000	His <i>et al.</i> (1999)
Kudos	1 week	23	Growth (2 days)	ca. 5000	His <i>et al.</i> (1999)
Linear alkylate sulphonate	1 day	NA	Mortality (6 h)	1000†	Renzone (1973)
Dodecylbenzene LAS 12C	NA	NA	Growth (1 week)	50‡	
	8–10 days	NA	Settlement (6 h expo.)	1000§	
Polyclens	1 week	23	Growth (2 days)	1000–5000	His <i>et al.</i> (1999)
Slickaway	NA	NA	NA	10 000–20 000	His <i>et al.</i> (1999)
Slik	1 week	23	Growth (2 days)	ca. 1000	His <i>et al.</i> (1999)
Sorbent-C	NA	NA	NA	ca. 100 000	His <i>et al.</i> (1999)
Teepol	1 week	23	Growth (2 days)	5000–10 000	His <i>et al.</i> (1999)
Tetrapropylene benzene	1 day	NA	Mortality (6 h)	2000†	Renzone (1973)
Sulphonate	NA	NA	Growth (1 week)	50‡	
	8–10 days	NANA	Settlement (6 h expo.)	1000§	
Tri-butyltin TBT	48 h	NA	Mortality	3.4	Thain and Waldock (1986)

EC<sub>50</sub>, toxicant concentration causing 50% reduction in the end-point; LC<sub>50</sub>, toxicant concentration causing 50% mortality; NA, data not available.

Several detergents were assayed as mixtures: in these cases, only the active components are mentioned and their percentages in the assayed mixture provided. Concentrations are expressed as µg L<sup>-1</sup> of active components.

†Referred to as 'lethal concentration'.

‡Mentioned as 'seriously affecting' growth.

§Mentioned as 'significantly reducing' settling and metamorphosis.

their early life stages, that is from the gametogenesis to larvae (Tallec *et al.* 2018).

As the list of pollutants in this review is not exhaustive, the emerging pollutants, notably PAHs, are not mentioned here.

### Oyster predators

Predation on adult and juvenile *O. edulis* can be multi-trophic and induce high mortalities. The main predators are invertebrates such as crustaceans, echinoderms and gastropods. In the class of gastropods, potential predators are for example the Atlantic dogwinkle *Nucella lapillus*, European sting winkle *Ocenebra erinaceus*, the Japanese oyster drill *Ocenebrellus inornatus*, the Asian rapa whelk *Rapana venosa* and the Atlantic oyster drill *Urosalpinx cinerea* (Philpots 1890; Hancock 1954; Garcia-Meunier *et al.* 2002; Zolotarev & Terentyev 2012). Examples for *O. edulis* preying echinoderms are the

common starfish *Asterias rubens* (Whilde 1985). For crustaceans, the brown crab *Cancer pagurus* and the shore crab *Carcinus maenas* (Mascaró & Seed 2001a; Mascaró & Seed 2001b) can be named. On a higher trophic level, there are also fish and birds preying on flat oysters. Predation on adult *O. edulis* by fish is noted in France and in the Adriatic Sea (Spencer 2008; Glamuzina *et al.* 2014). The fish species named there are the sea-bream *Sparus aurata*, the common stingray *Dasyatis pastinaca* and the common eagle ray *Myliobatis aquila*. The main diving avian predators of marine bivalves in Europe are the common eider *Somateria mollissima* and the common scoter *Melanitta nigra* (Fox *et al.* 2003; Spencer 2008); however, no data on the impact of these on *O. edulis* were found in the literature considered in this review.

The larvae of *O. edulis* are also subject to predation; known predators on these early stages are provided in Table 8.

**Table 8** List of known and presumed predators of *Ostrea edulis* larvae in the literature. NA is data not available

Name	Descriptor	Reference
<i>Aurelia aurita</i>	Linnaeus, 1758	Aase <i>et al.</i> (1986)
<i>Chaetognatha</i> † (larval stage zoea of the phylum)	NA	Auby and Maurer (2004)
<i>Cladocera</i> † (Superorder)	Latreille, 1829	Auby and Maurer (2004)
<i>Crepidula fornicata</i>	Linnaeus, 1758	Korringa (1951a)
<i>Decapoda</i> † (larval stage zoea of the order)	Latreille, 1802	Auby and Maurer (2004)
<i>Noctiluca scintillans</i>	(Macartney) Kofoid and Swezy, 1921	Dodgson (1922)

†Assumption to be confirmed.

## Genetics

### Population genetics

Lapègue *et al.* (2007) provides a valuable summary of research efforts conducted on nuclear genetic diversity and the geographical structure of *O. edulis* populations in Europe. Studies using enzymatic markers (Saavedra *et al.* 1995), microsatellites (Launey *et al.* 2002; Sobolewska & Beaumont 2005) and mitochondrial DNA (Diaz-Almela *et al.* 2004) have shown moderate differentiation between Atlantic and Mediterranean *O. edulis* populations. A significant correlation between geographical and genetic distances was found (Launey *et al.* 2002), supporting the distance-by-isolation model; excluding the case of populations at the limit of geographical distribution, such as the populations sampled in Norway and the Black Sea in the study of Diaz-Almela *et al.* (2004).

*Ostrea edulis* stocks have been subject to numerous transfers – as mentioned earlier in the introduction – for various reasons, although mainly for commercial interests (Bromley *et al.* 2016a). These movements of animals from different stocks have potentially diluted the structure and genetic diversity of naturally occurring populations. A minority of ancestors succeeds in replacing an entire population while the majority fails to procreate. Partial inbreeding may occur temporarily (Hedgecock *et al.* 2007) but gene flow resulting from larval dispersal ensures the connectivity between populations.

### Selective breeding

The selection of certain genetic characteristics in oyster aquaculture appears to have gained momentum since the late 1960s (Newkirk 1980). Genetic improvement through selective breeding since then focused on growth, weight gain, survival rate, disease resistance/tolerance, shell shape, shell colour or, more recently, intertidal tolerance of flat oysters. In some cases, growth may induce a better survival rate because oysters grow to their commercial size before diseases hit.

### Selection to improve growth

The earliest reported selection for growth in *O. edulis* was carried out in Nova Scotia, Canada (Newkirk & Haley 1982). Encouraging results on individual (mass) selection of growth rate and weight gain were obtained between 1977 and 1990. However, a profound influence of the environmental parameters rather than an influence of the selection on the results is discussed (Newkirk & Haley 1982). Nevertheless, Toro and Newkirk (1990) show differences between two groups of oysters where the selection has a significant influence on growth rate, but no influence on survival rates.

### Selection to improve resistance to bonamiosis

Genetic selection as a tool against mass mortality, for example caused by bonamiosis (see 5.1.1), was first discussed in France in 1985 (Baud *et al.* 1997), in Ireland in 1988 (Lynch *et al.* 2014) and in Spain in 2001 (da Silva *et al.* 2005) resulting in experimental breeding programmes for improving resistance. A significant increase in survival and a lower prevalence of the parasite in some oyster stocks was achieved. Mass selection can increase the resistance to a disease (Naciri-Graven *et al.* 1998) but also resulted in significant losses of genetic diversity and subsequent inbreeding, leading to the development of family-based selection. Despite these encouraging results, the low proportion of *O. edulis* produced in hatcheries, the biological specificities of the species and the technical difficulties of breeding have slowed down or even stopped the progress of breeding programmes.

So far, no large-scale breeding programme has been launched for *O. edulis* (Lapègue *et al.* 2007). Apart from the approach at Rossmore Breeding Ponds, where the seventh generation survivors of oysters that are surviving bonamiosis are breeding. In most years since the bonamiosis reached the site of Rossmore in 1987, between 10 000 and 20 000 oysters has been used every year, to breed another generation (Lynch *et al.* 2014).

The search for quantitative trait locus (QTL) for bonamiosis resistance in *O. edulis* is a promising approach (Lallias *et al.* 2009), and the recent development of a SNP

array (Gutierrez *et al.* 2017; Vera *et al.* 2019) opens up new perspectives such as genomic selection.

### Crossbreeding and hybridization

The production of crossbred animals resulting from a crossing between different oyster stocks/origins in order to obtain a better performance is a method to improve production developed in agriculture and aquaculture. This increase in performance can be explained by the process of heterosis (Newkirk 1980).

Interspecific hybridization and crossbreeding have been tested for *O. edulis* without notable success. Cross-breeding experiments by Newkirk (1986) showed little evidence of a better vigour of hybrids from two different broodstock origins. An interspecific hybridization of *O. edulis* and *C. gigas* did not produce conclusive results: a low rate of oocyte evolution and replications without cell divisions after fertilization are reported (Gendreau 1988).

### Polyploidy

Research on the modification of chromosome numbers in bivalve aquaculture appeared in the 1980s to prevent the spawning phase but also as a potential pathway for obtaining resistant animals (Gendreau 1988; Nell 2002). So far, two types of polyploid oysters, triploids and tetraploids, were developed. Tetraploids oysters are produced for further crossing diploid oysters, resulting in the production of triploids oysters (Yang *et al.* 2018).

Triploid oysters may increase (in some cases and species) the growth rate (Guo *et al.* 1996), may allow the protection of the hatchery product and may decrease the genetic impact of hatched oysters and natural populations (Hedgecock 2011). However, differences in survival rates between diploids and triploids are not clear due to interactions with diseases or other stressors and the difference of ploidy level for each situation and oyster species (Nell 2002).

The first induction of polyploidy applied to oysters, in this case triploidy, was described for *C. virginica* (Stanley *et al.* 1981). In 1988, a method for artificial fertilization of *O. edulis* and extra-pallial larval breeding (triploids, tetraploids, allotriploids) was described and allowed experiments with different methods of polyploidy induction (Gendreau 1988; Gendreau & Grizel 1990). Later triploidy was induced by meiosis I blockage (instead of meiosis II blockage) and resulted in increased growth rates (Hawkins *et al.* 1994).

Gendreau (1988) tested two methods of inducing triploidy: induction by chemical treatment and induction by hyperbaric treatment. The first method consists of treating fertilized eggs during their preliminary phase with the

expulsion of one of the two polar globules of cytochalasin B. A standard protocol was adapted to *O. edulis* based on the standard method of Downing and Allen (1987) with a treatment temperature of 20°C and an increased duration of the treatments up to 20 min. The second method, the hyperbaric treatment, consists of applying a pressure shock at the time of expulsion of the polar globules and the first mitotic cleavage. 10 and 120 min after fertilization, a pressure of 48.2633 MPa is applied every 10 min for a period of 5 min. This hyperbaric treatment is a viable method but the time of application has a significant influence on the frequency of induced polyploidy: ranging between 48% and 73% of triploids (Gendreau 1988).

Results obtained with the chemical induction of triploidy by cytochalasin B (treatment of 1 mg L<sup>-1</sup>) are ca. 69% of triploid oysters larvae (Gendreau 1988; Gendreau & Grizel 1990). The triploidization method used by Hawkins *et al.* (1994) is almost identical.

The production of tetraploids of *O. edulis* was described and tested by Gendreau (1988) and Gendreau and Grizel (1990) applying the same methods: cytochalasin B (chemical) and hyperbaric treatment. Results for hyperbaric treatment are identical to triploidy induction, but only a 16% tetraploidy level was obtained (Gendreau 1988). Induction by chemical treatment induced a rate in the range of 40–53% tetraploidy (Gendreau & Grizel 1990).

As mentioned above, triploid oyster production is uniquely dedicated to aquaculture and has no direct application in ecological restoration.

Spawning induction and artificial fertilization will be discussed in chapter 7.4.

## Seed exploitation

### Growing demands and the development of oyster aquaculture

#### *Early days: the ancient world*

For thousands of years, oysters have been fished and harvested as a relevant food source, but also for other usages. The use of oysters for healing wounds for example was already mentioned by Hippocrates of Kos in his time (Voultsiadou *et al.* 2010). Only little is known about the cultivation of oysters in the Mediterranean antique (Yonge 1960). However, some Roman production methods and the first Greek trials are documented. These methods still persist today, although they were not developed based on scientific knowledge.

During the 4th century BCE, Aristotle initiated the scientific approach of oyster reproduction in his 'Treatise on animal generation' in Greece and documented the history of seed breeding and production testing (Barthélemy-Saint Hilaire 1887). According to his writings, oysters were found by sailors landing in Rhodes, growing on broken clay pots

and other shards thrown into the water. These are the first references of oyster seed collection. Furthermore, Aristotle describes first attempts of breeding trials: adult oysters were transplanted from the island of Lesbos into a nearby sea. There, they grew rapidly but did not seem to reproduce.

This precious documentation was undoubtedly the inspiration for a Roman named Caius Sergius Orata. Gaius Plinius Secundus reports that this Sergius Orata successfully established oyster beds in the area of Baiae or Puteoli for the first time in the 1st century BCE. The methods of cultivation he used and how the supply of juveniles was organized is unknown. It is likely that at that time young oysters were collected at sea and placed in the salt waters of Lucrin or Fusaro lakes for refining and reproduction (Coste 1861; Locard 1900). Since then, Italy was the European leader in inventing and using advanced marine mollusc farming methods until the 19th century (Corlay 2001).

#### *New momentum: seed collection and production in the modern age*

In the 17th century, oyster culture in France began in salt marsh pools of the Atlantic coast, followed by culturing stocks in constructed ponds (Héral 1990). Seed oysters were collected or dredged and placed in these ponds until they grew to a size where they could be sold (Héral 1990; Buestel *et al.* 2009). From the 18th century on, natural beds of *O. edulis* were overexploited on the French Atlantic coast due to high demands. Accordingly, decrees were issued which forbid the harvesting of *O. edulis* during the breeding season (Héral 1990).

The decline in natural oyster stocks all around Europe raised the concerns of public authorities at that time. Research and experimentation programmes were set up in France as well as in other European countries. All this scientific and administrative expense had one objective: the regeneration of natural oyster beds, mainly driven by commercial demands (Roché 1898).

Modern oyster culture, defined as the culture of oysters from captured seed, began in the 1850s (Héral 1990). Simultaneously, several different techniques for seed capture were developed around Europe.

In 1852, de Bon and Coste were commissioned by Napoleon III to restore the French oyster stocks. They initiated a repletion and reseedling programme mainly based on using wooden seed collectors similar to those used in Italy at that time. This project marked the beginning of French oyster culture with the control of seed supply (Gouilletquer & Héral 1997).

In 1878, the Norwegian Government also investigated the possibilities of restoring the depleted Norwegian oyster beds (Strand & Vølstad 1997) and discovered the remains of natural beds in so-called polls: shallow, well-sheltered

salt-water pools where the water temperature did rise sufficiently high in summer to allow larval development (Korringa 1976). These polls (breed polls) were used for oyster farming, and a system hanging collectors for collecting seed was developed. These cultures were intended to restore the depleted oyster beds for a re-establishment of the commercial fishery (Strand & Vølstad 1997).

From 1868 on, the oyster species *C. angulata* was accidentally introduced from Portugal, leading to the colonization of the French Atlantic coasts (Buestel *et al.* 2009). It was produced in parallel with *O. edulis* and replaced the flat oyster at the main culture sites after the mortality events in the 1920's (Buestel *et al.* 2009, see also chapter 5.1). Thereafter, the development of production technologies for the European flat oyster was less relevant and stagnated.

An overview of seed production systems in different European countries (restricted to Belgium, England, Germany, Italy, the Netherlands, Portugal and Spain) is presented in Dean (1891). It identified three categories: (i) Countries with no seed production (Belgium); (ii) Countries allowing stocks to develop and then exploit the biomass surplus of these oyster beds (Germany, Portugal and Spain, Denmark and Ireland; Kristensen 1997; Culloty & Mulcahy 2007); (iii) Countries using seed collectors for the settlement of oyster larvae at sea or in breeding ponds (Italy, France, England and the Netherlands).

The European flat oyster was and still is of interest also in the eastern Mediterranean. In Croatia, oyster farming was regulated by the law already in 16th century, and the wild seed has been collecting on tree branches or later on clay roofing tiles set on the seabed by the 1980-ties, but bunches of plastic nets and series of plastic discs hanged on suspended longlines are widely used today (Korringa 1976; Skaramuca *et al.* 1997; Benovic 1997; Tomšić & Lovrić 2004; Bratoš *et al.* 2004). Turkey and Bulgaria established seed production or collection only since the end of the 20th century (Alpbaz & Temelli 1997). For all other countries along the Black and Mediterranean Seas, no information on *O. edulis* production methods was available in the reviewed literature.

#### *Further progress with controlled breeding: controlled fertilization and hatcheries*

So far, the extensive culture of *O. edulis* was not always economically viable. In the 20th century, processes to stabilize this industry were developed, which were directly related to the development of production techniques for hollow oyster seed, the flagship product of the shellfish industry.

In 1849, controlled fertilization of oysters and reseedling of depleted oyster grounds with these larvae was suggested for the first time in France (Roché 1898). However, it was not until 1879 that the first artificial reproduction tests

were carried out on American oysters (*C. virginica*) in the laboratory (Brooks 1879). In order to meet the rising demands, artificial reproduction techniques were further promoted. In the United Kingdom, artificial breeding of *O. edulis* was developed mainly by the work of Cole (1937), who successfully reared a high number of larvae to metamorphosis in large outdoor tanks (Alagarswami 1982). Bruce *et al.* (1940) were probably the first to develop laboratory methods for rearing larvae of *O. edulis*. In the following decades, a considerable effort was made to identify and cultivate phytoplankton species for feeding flat oysters (Loosanoff & Davis 1963; Walne 1965; Mann 1984).

Since then, the production of oyster seed on land has developed and evolved considerably: from experimental laboratory production to large-scale hatcheries. Between the 1960s and 1980s, significant advances were achieved in broodstock conditioning, larval culture and survival, larval energetics, composition of algal feeding and cultchless seed production (Mann 1984). The first true and complete manual for hatchery bivalve culture was provided by Dupuy *et al.* (1977) for *C. virginica*.

By comparing the first manual from Dupuy *et al.* (1977) to the current general manual (not specialized on a given species) on marine bivalve hatchery of Helm *et al.* (2004), many evolutions in hatchery design, breeding operations and production success have been achieved (Mann 1984; Helm *et al.* 2004; Goulden *et al.* 2013). Nevertheless, although knowledge of seed production in *O. edulis* hatcheries is substantial, seed exploitation is still mainly based on the collection of seed from natural stocks.

### New demands: oyster reef restoration in the context of ecological restoration

The restoration of oyster habitats in the context of ecological restoration is a new development. It can be clearly distinguished from reseeded and restocking attempts that aim at the stabilization of commercial exploitation and at the satisfaction of market demands via aquaculture or fishery.

The beginning of ecological restoration as a discipline dates back to the 1860s. It was founded in southern Europe for forest environments and reforestation (Vallauri *et al.* 2002) and constantly increased in relevance over a number of different environments and scales, such as terrestrial, freshwater and marine ecosystems (Clewel & Aronson 2013). Today, it is defined as the process of assisting the recovery of an ecosystem that has been degraded, damaged, or destroyed and is recognized as a critical tool for mitigation and active conservation (Gann *et al.* 2019).

Oyster habitat restoration desires the restoration of ecological functions of oyster reefs, which are manifold and diverse. They include biodiversity enhancement, increase in

water quality (by clearance of the water column), nutrient removal, sediment fixation, benthic-pelagic coupling and coastal stabilization (Coen & Luckenbach 2000; Pogoda 2019).

In Europe, the restoration of *O. edulis* has gained momentum and presents a new stakeholder in seed oyster exploitation with specific demands regarding quality and quantity. The topic is of interest for governmental or non-governmental nature conservation organizations, for researchers and resource managers, focusing on habitat restoration and biodiversity enhancement, as well as for commercial producers (Laing *et al.* 2006; Kerckhof *et al.* 2018; Pogoda 2019).

### Seed production

Different production approaches and techniques exist for the production of seed oysters. An overview, including detailed descriptions and application ranges is presented here.

### Seed collection

In Europe, today, the majority of *O. edulis* seeds for aquaculture production come from wild collection, also called sea-based collection (Anonymous 2006b).

The two main collection techniques that exist today are as follows: (i) the placement of cultch/collectors such as bivalve shells on the seabed as in the case of in the Netherlands (Lake Grevelingen), in England (Blackwater estuary and the Fal river), in Scotland (Loch Ryan) and in Ireland (Lough Foyle, Galway Bay and Tralee Bay), (Fig. 4) (Engelsma *et al.* 2010; Bromley *et al.* 2016b; Eu-Commission 2018; McGonigle *et al.* 2020; Anonymous 2020a; Anonymous 2020b; Anonymous 2020c; Anonymous 2020d); (ii) the suspension of collectors or even the placement of collector on bottom bound structures such as tube nets (Fig. 5b) filled with bivalve shells (mainly *M. edulis* shells) over oyster beds or limed conical discs made of plastic (Fig. 5d) in cages as in Quiberon Bay and Brest Bay in France (Arzul *et al.* 2006). The second technique is also used in Mali Ston Bay and the West Coast of Istria in Croatia (Zrnčić *et al.* 2007), and in Kotor Bay in Montenegro (Peraš *et al.* 2018) using plastic discs or empty plastic nets suspended between two metal rods (Bratoš Cetinić & Bolutin 2016).

In both techniques, collectors are placed in the time window of the swarming (see Section Swarming) of *O. edulis* larvae. Long after the collection period, when the spat size reaches 5–6 mm, the collectors can be transferred to grow-out areas or the spat removed (Anonymous 2006b).

Seed collection has several advantages: the low investment and operating costs (preparation, deployment and

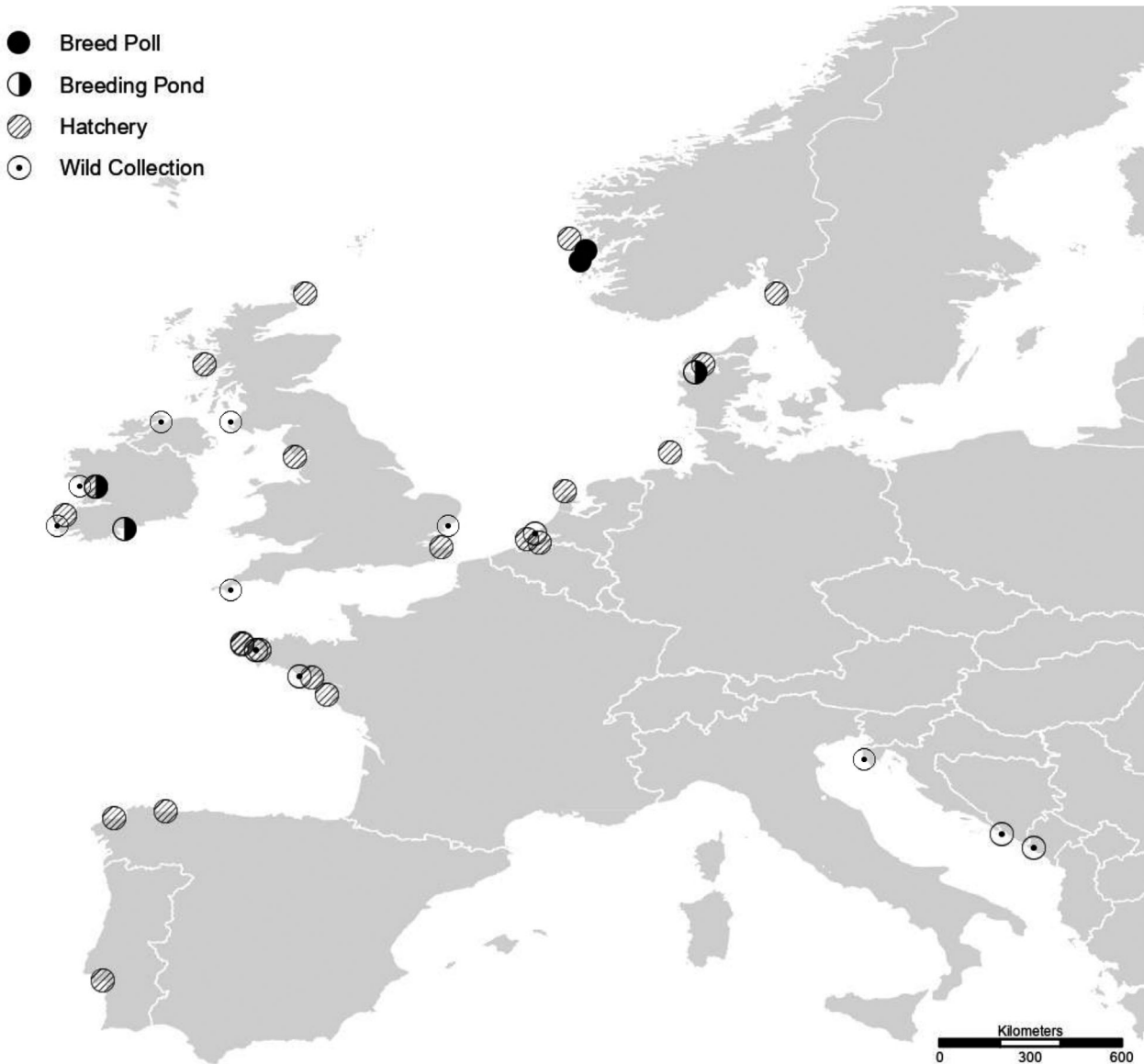

**Figure 4** Map of distribution of seed suppliers of *Ostrea edulis* in Europe: production (see Table 9) and collection sites (see chapter 7). (●) breed poll; (◐) breeding pond; (◑) hatchery and (◒) wild collection.

harvesting), compared with a hatchery for example; the number of broodstock can potentially (under optimal biological and hydrological conditions) induce a high genetic variability (Diaz-Almela *et al.* 2004; Lallias *et al.* 2010); the number of collectors and oysters breeding (under optimal biological and hydrological conditions) can allow a very high productivity (see chapter 6.1 and Fig. 1).

Seed collection has however major disadvantages: this technique is not possible everywhere in Europe, the production is seasonal, does not allow genetic selection, is not recommended for translocation scenarios in ecological restoration (zu Ermgassen *et al.* 2020b) and the settlement

rate is dependent on environmental conditions. Regarding this last aspect, as mentioned in chapter 3.7.1, the settlement of *O. edulis* may be affected by numerous factors (see chapter 3, 4 and Fig. 3), and therefore, the production is dependent on the environment. Major fluctuations can be observed from year to year (Tardiveau 2020), which affect the production and its stability considerably in some years.

The collection of *O. edulis* larvae in the wild is an appropriate and sustainable approach in areas where reproductive flat oyster populations remain. Accordingly, a renewed interest from science and production perspectives to improve and increase and/or stabilize the production to



meet new demands from restoration measures can be expected.

Nevertheless, the variety, efficiency and long-term effects of wild seed collection techniques are not included here as the literature on the subject is very large and existing results of the performance are stated non-comparably. Furthermore, this complex aspect involves a wide number of factors to be considered and would qualify for a full review itself.

An example of seed collection (non-sea-based) techniques from the past: the Fusaro lake in Italy (Box 2).

### Box 2. Lake Fusaro

Seed collection of oyster from the past inevitably includes the example of the salt lake of Fusaro in Italy. Located between Lake Lucrin and Cape Misene, it was considered and described by Coste (1861) and Dean (1891). This example, which includes a temporary closure of the salt lake, is at the boundary between collection and production techniques. Coste (1861) reported in his report on oyster farms in Italy that at Lake Fusaro he observed from distance to distance the most ordinarily circular spaces occupied by stones that would have been transported there. These stones are piled up in a pyramidal manner simulating rocks. These stones are then covered by oysters that were imported for example from Taranto. These dummy rocks or artificial beds of oysters with a diameter of between two and three metres are surrounded by piles planted at regular intervals close enough to each other to circumvent (Figure 5a). These circumferential piles protrude slightly above the surface of the water so that they can be grasped and removed when necessary. Next to these artificial benches, other piles, linked together by a rope from which bundles of wood are hung for seed collection, are aligned in a straight line (Figure 5c).

The characteristics of Lake Fusaro are more broadly described by Dean (1891). At that time, the lake was crescent-shaped with a circumference of 4.8 km. At each end, canals would have allowed communication with the sea. The depth of the lake would have been 1.5 m on average, with deeper areas of up to two meters. This shallow depth allowed its temperature to grow quite easily and temperature regulation was possible by admitting new seawater.

At the end of the 1960s, the Lake Fusaro industry was destroyed by volcanic causes and poor management and maintenance of the breeding sites (Dean

1891). However, oyster farming was re-established in the 1880s, abandoning the pyramid-shaped collectors described by Coste (1861). It seems that the management of Lake Fusaro as a closed lake was largely a failure. These failures to have been due to a strong rise in temperature, forcing the producers to frequently renew the seawater and consequently let the larvae escape from the lake, but it is also reported that the settlement was very irregular from year to year in Fusaro.

We found no trace in the literature of the fate of seed production methods in Fusaro since then (Dean 1891).

## Breed polls

### Definitions

The traditional Norwegian breeding system of *O. edulis* is the Østerspoll (here suggested as 'breed poll'), for which many synonyms exist: Norwegian oyster pond, salt-water pond, salt lake, poll, landlocked heliothermic marine basin, Norwegian oyster bassin, Norwegian oyster-poll, small oyster lagoon, landlocked fjord, heliothermic poll or even solar pond. It should not be confused with what is called 'spat-poll', basseng or Norwegian spitting pond, which are larger, shallower basins not closed and exposed to tidal exchanges within the fjords. 'Spat-polls' are generally used for the *O. edulis* spat grow-out whereas the 'breed polls' is solely reserved for breeding. Other types and names of basins are described in the literature as 'Bukt' and 'Kil' (Gaarder & Bjerkan 1934; Bøhle 1984) but do not seem to meet the requirements necessary for reproduction.

The poll is a natural biotope, distinct from a fjord and is suggested as a specific geographical feature (Matthews & Heimdal 1980): Polls are enclosed systems, a few kilometres long and 5–12 (metres) deep (Friele 1899). The sill depth is less than the depth of the pycnocline (few metre depths, e.g. 4–8 m). For the cultivation of *O. edulis*, polls can be closed temporarily.

Kirkland *et al.* (1980) describes heliothermic processes for these polls: Solar radiation is absorbed and converted into heat by the dark, muddy bottom of the poll. Conditions required for the development of heliothermal energy are density differences between the upper layer (mixolimnion), intermediate layer (chemocline) and lower layer (monimolimnion). The upper layer of water can be relatively fresh (e.g. salinity of 5.5 at Espevick, Norway) and floats on a brine. Salinity passively affects the density by evaporation, eventually out balanced by soluted salt. A salinity difference of one per cent between upper and lower layer will obtain a temperature of up to 25–30°C within the chemocline for a short period in summer (Gaarder & Bjerkan 1934; Korrington 1940).

The fresh top layer prevents vertical heat exchange because the warm salt water remains heavier than the

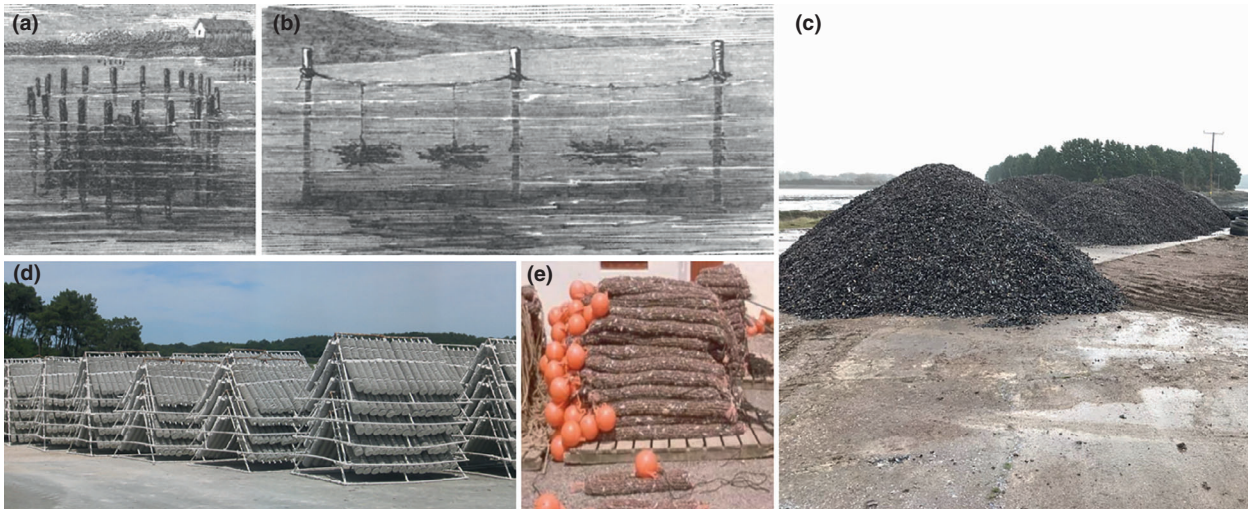

**Figure 5** Seed collection: examples of oyster spat collectors from the past and present. (a) Artificial oyster beds surrounded by wooden piles used in the salt lake of Fusaro in Italy; (b) wood piles placed in a straight line and joined by a rope that suspends bundles of branches piles used in the Fusaro lake in Italy and today in Croatia; (c) pile of cultch (*Mytilus edulis* shells) in deposit before placement on the seabed of the Loch Ryan, UK; (d) Another example of a collector used nowadays in Brittany, France: the plastic lined disc, here on a cage for future immersion in a lime bath and then in the sea; (e) tubular nets filled with mussel shells, here attached on floating buoy for longlines. Modified after Coste (1861) (a,b) and photographs from Tristan Hugh-Jones (c), H el ene Cochet (d), Anonymous (2006b) (e).

cooler top layer. During the day, the upper layer transmits most of the solar rays, at night it serves as a cover (Gaarder & Bjerkan 1934; Korringa 1940). Due to these very specific hydrographic conditions, water temperatures stay constantly high enough for the oysters to reproduce successfully – even in these high latitudes.

Breed polls sustain and contribute to *O. edulis* production in Norway (Fig. 6). Information on breed polls used for *O. edulis* aquaculture is available in Strand and V olstad (1997).

#### Breeding protocol

Breeding operations begin with the supply of broodstock within the breed poll (Korringa 1976). Although adult oysters are present inside the breed polls, a significant production of larvae will require the addition of several thousand 3- to 4-year-old oysters. Broodstock is suspended in the warm water layer that provides a sufficient oxygen level as the muddy soil eventually lacks oxygen during mid-summer and leads to the formation of hydrogen sulphide (Korringa 1940; Yonge 1960). A



**Figure 6** Breed polls schematics and illustrations of a breed poll: (a) view from above of a breed poll and connectivity to the Fjord, (d) drain that can be closed, (f) inlet of freshwater; (b) profile view of a breed poll and connectivity to the fjord, (d) drain that can be closed; (c) schematic of the method for hanging seed collectors, (sc) suspended seed collectors; (d) view of the dam of the Inner oy Poll in Norway; (e) aerial view of the Inner oy Poll. Modified after Gaarder and Bjerkan (1934) and photographs from KVB and Anonymous (2017).

prominent suspension method is longlines with broodstock baskets.

The second step of a breeding operation is the preparation and installation of the collectors. In Friele (1899) and Korringa (1976), two types of collectors are described: (i) collectors made of dried branches of birch (*Betula* spp.) or common juniper (*Juniperus communis*) without their thorns and (ii) collectors consisting of square mesh pieces made of galvanized wire. The first collector type is suspended from a longline with a ground weight. As for the second type of collector, two square pieces are superposed and often intertwined with twigs of juniper, hazelnut (*Corylus* spp.) or birch (never with Alder *Alnus* spp). Eventually, these collectors are coated with cement. Details of current practices were not found in the literature.

Shortly before the larvae are ready for settlement, regular water sampling determines optimal timing for collector installation. At a density of about four to five larvae per litre and a good larval development, the exposure period can be estimated. Since larval concentration is not equal throughout the whole depth of the breed poll, empirical observations, which may take a few years, are necessary. Accordingly, the installation depth of the collectors can be estimated (Korringa 1976). As collectors are affected by biofouling, they are removed from the water, landed for a drying period and then returned back for collection (Korringa 1976).

Finally, the last operation is harvesting the seed. After the settlement of larvae is completed, the breed poll will be reopened for water exchange with the fjord. The seed overwinters on the collectors within the breed poll. During spring, the producers harvest the juveniles by boat and special detaching tools.

#### Food supply

Natural food supply in the breed polls is highly efficient: oysters grow quickly and are marketable with 3 years (Yonge 1960). However, in less sunny summers, phytoplankton is less abundant, which leads to lower growth rates and significant harvest losses (Korringa 1976). Klaveness (1990) has shown how, among other factors such as temperature and salinity, fluctuations in *O. edulis* production can be explained by a total or partial lack of food and subsequent malnutrition of larvae. Various experiments and measurements were carried out to understand and optimize algal production and thus optimize the production of *O. edulis* in breed polls (Klaveness & Johansen 1990; Klaveness 1990; Klaveness 1992; Ulvestad & Strand 1997).

#### Risks and diseases

The first systematic monitoring of the health status of *O. edulis* in Norwegian breed polls was carried out in 1989 (Mortensen 1992). Until 2016, none of the parasites

*B. ostreae*, *B. exitiosa* and *M. refringens* were detected. The protist *B. ostreae* was initially detected in Western Norway in 2009 (Engelsma *et al.* 2014) where also *M. refringens* occurred for the first time in 2016 (Mortensen *et al.* 2018). However, they did not occur in breed polls so far.

A known risk is the potential mixture of water layers within a breed poll: (i) mixed bottom and middle waters may cause hydrogen sulphide mortality in broodstock and seed (Yonge 1960); (ii) mixed layer of freshwater with the seawater underneath may result in the inability of the heliothermal process (cited above) to warm seawater (Korringa 1976). In addition, Korringa (1976) reports that oysters reproducing at high temperatures in the breed polls appear to be sensitive to low winter temperatures that, combined with low salinities due to high rainfall, result in elevated mortalities. In general, mortality as well as predation pressure is low in the suspended culture systems (Korringa 1976).

#### Performance and further development

During the bibliographic search and analysis of this production technique, very little data were found on the output numbers of annual seed harvested. According to Strand and Vølstad (1997), between 1903 and 1988 an estimated average of 3.2 million *O. edulis* seed were produced per year in breed polls. Production peaked in 1989 with 12 million spat, but fell back to only one million in 1990. No comparable data regarding collector type, production in breed poll or seed size were available.

In the 1880s, a number of production companies were created with high investments in breed polls. However, it seems that this effort was only temporary. Only two companies were identified a century later (Strand & Vølstad 1997): Ostravigpoll and Espevikpoll. There is no recent reference to the production and the current state of this technique. But obviously, breed polls are also used as nurseries for hatchery seed (Anonymous 2011).

The unpredictability and limited capacity of the traditional production of *O. edulis* in breed polls have resulted in newly developed production technologies (Strand & Vølstad 1997).

Breed polls maintain a high genetic diversity (Lallias *et al.* 2010), which supports ecological restoration of *O. edulis*; although this system is specific to Norway. A renewed interest from science and production perspectives to improve and increase breed poll production to meet new demands from restoration measures could be expected.

#### Floating breeding bags in breed poll

Inspired by the large-scale production of juvenile flatfish in underwater plastic bags, these techniques were successfully adapted for the production of *O. edulis* larvae (Naas *et al.* 1986; Naas 1991).

In the initial experiments, this technique consisted of semi-transparent plastic bags with conical bottoms that are filled with seawater filtered at 200 µm at a salinity of 30. These polyethylene semi-floating bags had a depth of 2.7 m and a volume of five cubic metres. Between three and six broodstock oysters were placed inside them. During the pelagic phase of the larvae, no water renewal was carried out and for the settlement phase, PVC sheets were inserted into the bags to settle onto.

This system is estimated to produce 130 000 *O. edulis* spat per plastic bag, containing three broodstock oysters and achieving an average settlement rate of 7.9%. Although this seems to be a low-cost method that requires very little expertise on seed production, this method does not seem to be used or is at least no longer cited in the literature today.

## Breeding ponds

### Definitions

The 'breeding ponds' (suggested name here) production technique, also known as 'spatting ponds', is carried out in entirely man-made ponds. Many projects, trial reports, production protocols, book chapters or even scientific articles refer to them as 'oyster ponds'. This vague term can be confusing. Thus, it is necessary here to clearly distinguish oyster storage ponds (before marketing or merely in winter), refining and greening ponds typical of the Marennes-Oleron region (France), reparking or grow-out ponds or even purification ponds, which do not contribute to seed production itself.

The development of this technique for the production of oysters in Europe dates back to the 1860s (Spencer 2008). Examples regularly cited in the literature are as follows: the Beaulieu river breeding ponds (Hampshire, UK), the Hayling island breeding ponds (Hampshire, UK), the Breneguy breeding ponds (Locmariaquer, France), the Conway breeding ponds (Conwy, UK), the River Yealm breeding ponds (England, UK), the Port Erin breeding ponds (Isle of Man, UK), the Tholen breeding ponds (Tholen, the Netherlands) and the Rossmore breeding ponds (Cork, Ireland) (Beaulieu 1890; Dean 1890; Orton 1937; Hughes 1940; Korringa 1951b; Walne 1974; Hugh Jones 1999; Spencer 2008).

### Examples

As reported, the Hayling Island Breeding Ponds were enormously successful in 1868, when 80 million spat were produced from 32 ha (Spencer 2008). Seed was collected from bundles of twigs, wooden hedges, shells, slates or even stones.

Following this resounding success, productions in breeding ponds were also developed elsewhere but only with

temporary success as in the case of most of the French attempts. But despite these irregularities, the Breneguy Breeding Ponds operations in France were fruitful and promising and followed a general routine (Dean 1890): (i) During winter, the pond dries out for at least 2 months, which allows the basin to purify itself deeply by crumbling and mixing muddy dried areas with gravel and clay, but also by removing plants and animals (e.g. potential predators, competitors); (ii) Shortly after early spring, water is gradually admitted into the breeding ponds; (iii) After a period of about a week, spawning oysters are introduced and dispersed (across about 40 m<sup>2</sup>) to deeper waters; (iv) The exchange of water by tide occurs at least once a day until the first observation of larvae when the breeding ponds subsequently are closed – this is also the signal for the placement of the collectors; (v) The breeding ponds stay closed until autumn, resulting in larval retention and optimized settlement. Water renewal is only necessary a case of massive evaporation; (vi) Collectors with oyster seed can be collected.

Furthermore, it is important to have a large surface area of the pond in order to secure good air absorption and good water circulation through the wind, to have a minimal but continuous supply of new seawater to compensate for evaporation and to ensure a sufficient water depth to protect against sudden changes in temperature or salinity.

However, in 1979, new breeding ponds were built in Cork, Ireland (Fig. 7). The problem of production variability over consecutive years was addressed and successfully solved by building many ponds: 22 in total. These shore based man-made ponds are 20 × 20 m by 2 m deep and contain 1000 m<sup>3</sup> of seawater during production. A single pump conveys the water, and no filter or sterilization of seawater is carried out. Underground drains, allowing the transfer of water and ensuring better management control, connect the breeding ponds. The drains are lined with butyl rubber but can be made of hard rubber as well. The breeding protocol, although similar to that of Breneguy, provides more specific information: (i) Breeding ponds are filled with seawater only once a year in summer; (ii) No food is added. Food is provided by the pond ecosystem including microalgae blooms (Rogan & Cross 1996); (iii) Temperature, pH, pond colour, weather conditions and reproduction stage of oysters (Table 3) are constantly monitored. The collectors used here are mainly mussel shells (*M. edulis*) scattered one by one at the bottom of the tanks for manual harvesting. In other breeding ponds such as in Ireland and Denmark (Fig. 4 and Table 9), other collector types are used such as flat plastic collectors or plastic 'couples' with or without slaked lime.

Although there are a multitude of possible designs for the creation and operation of breeding ponds, three practical handbook/manuals exist today in the literature: the



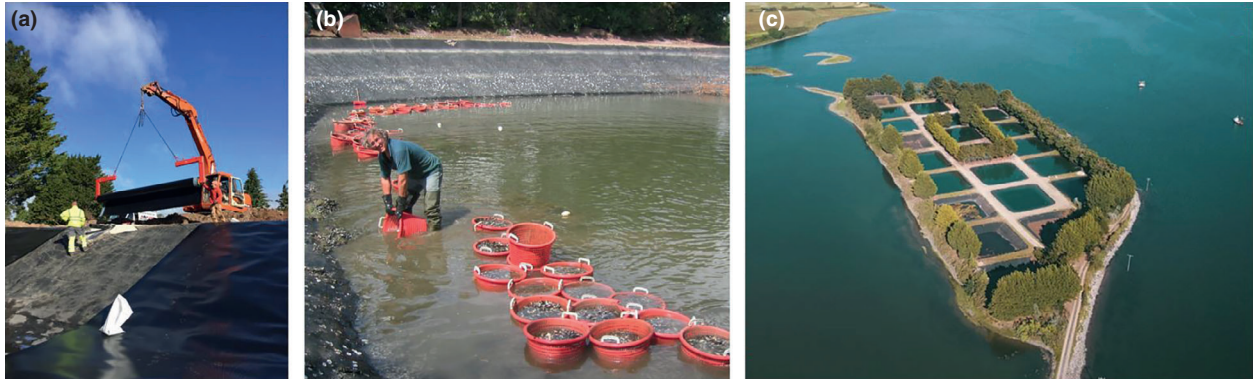

**Figure 7** Rossmore Breeding Ponds (Cork, Ireland): (a) repair/construction of breeding ponds in 2019: installation of the liner; (b) harvesting of seed on shell and placement in baskets for transport to the grow-out site; (c) aerial view of the 21 breeding ponds. Photographs from Tristan Hugh-Jones.

manual of Connellan (1995), the report of Syvret *et al.* (2017) and the manual of Strand *et al.* (2018).

#### Performance

The bibliographical search identified only scarce information on the production of oysters in breeding ponds and even less on their performance. However, at Rossmore Breeding Ponds, when 75% of the breeding ponds are productive, the expected yield is in the range of 2 million five-millimetre size seed per pond (Spencer 2008). The actual production from the breeding ponds of Rossmore for the years 1993–2003, in years after the development of bonamiosis (since 1987 in Cork) are shown in Appendix S3.

In general, breeding ponds maintain a high genetic diversity (Lallias *et al.* 2010), which supports ecological restoration of *O. edulis*. Accordingly, a renewed interest from science and production perspectives to improve and increase breeding pond production to meet new demands from restoration measures can be expected.

#### Hatcheries

Hatchery production of *O. edulis* was investigated by applied scientific approaches as irregular and insufficient supply of wild seed had increased the importance of hatcheries in the production of oyster seed. The EU-funded projects SETTLE (FRP/2007–2013 Grant 222043), OYSTERECOVER (FP7-SME-2008-2 Grant 243583) and LARVDEOPTI (FP7-PEOPLE Grant 273851), focused on several critical aspects of flat oyster production both in hatcheries and in the field. However, the state of the art in hatchery production of *O. edulis* is still incomplete and does not provide a reliable protocol for flat oyster conditioning and larval production in hatcheries throughout the year.

Several critical and challenging steps in hatchery production have to be addressed to generate a constant supply of healthy oyster seed: (i) Broodstock has to be conditioned to accelerate gonad development to increase the number of produced larvae. Successful broodstock conditioning will also allow maturing and spawning outside the natural season; (ii) High, synchronized and reliable settlement success and metamorphosis have to be established to secure successful post-settlement growth and survival.

The further development and application of specific techniques, such as artificial fertilization, cryopreservation, remote setting, polyploid production support the respective steps in hatchery production or have the potential to do so in the future.

#### Biosecurity

Biosecurity in bivalve hatcheries can be summarized in three levels (Spark *et al.* 2018): (i) Identification and control of biological and non-organic inputs (e.g. water, air, feed, animals, pathogens and employees); (ii) Internal biological and non-organic control; (iii) Control of production products and effluents (e.g. water, live animals, faeces and dead animals). This broad field will not be covered here in its entirety, but references on some points will be given below.

The water treatment of *O. edulis* hatchery is carried out today by different methods: chlorination, ultraviolet radiation, pasteurization or ozonation (Prado *et al.* 2010). The storage of untreated water may increase the risks (Jones 2006).

The treatment of broodstock and their fouling before entering the hatchery is a crucial phase (Coatanea *et al.* 1996). The elimination of fouling and epibionte for *O. edulis* can be carried out in different ways, which can be summarized as follows (van den Brink & Magnesen 2018): manual scrapping, brine bath, chlorine bath or in a cement mixer.

**Table 9** List of seed suppliers of *Ostrea edulis*

Country	Name	Addresses	Production technology	Status and aim	<i>Bonamia</i> sp. free spat
Canada	Dalhousie University Aquaculture Center	Truro, Nova Scotia, B2N 5E3 1-902-893-6600 – www.dal.ca	Hatchery	Active? Research	NA
Denmark	Dansk Skaldyrcenter	Øroddevej 80 7900 Nykøbing Mors – www.skaldyrcenter.dk	Hatchery	Active Research	NA
Denmark	Venø Fish Farm AS – Aquamind AS	Sønderskovvej 9 Venø 7600 Struer – www.venoe.dk	Breeding Ponds	Active? Commercial	NA
England, UK	Colchester Oyster Fishery Ltd	Pyefleet Quay, East Road, East Mersea, Colchester, Essex, CO5 8UN – www.colchesteroysterfishery.com	Breeding Ponds†	Active? Commercial	NA
England, UK	Seasalter (Walney) Ltd	Old Gravel Works, South Walney Island, LA14 3YQ Cumbria, England – www.morecambebayoysters.co.uk	Hatchery	Active Commercial	Yes
England, UK	Seasalter Shellfish (Whitstable) Ltd	Old Roman Oyster Beds, Reculver, Herne Bay, CT6 6SX Kent – www.oysterhatchery.co.uk	Hatchery and Breeding Ponds	Active? Commercial	NA
France	CRC Bretagne Nord Shellfish Technical Centre of Porscav	Rue de l'Aber 29810 Lampaul-Plouarzel – www.cnc-france.com	Hatchery	Active Restocking	NA
France	Ferme Marine de l'île d'Arun EARL	Chemin de la pointe du Glugeau 29460 Hanvec	Hatchery	Active Commercial	NA
France	IFREMER Experimental site of Argenton	Presqu'île du Vivier 29840 Argenton – www.ifremer.fr/argenton	Hatchery	Active Research	NA
France	Novostrea Bretagne SAS	Banastère 56370 Sarzeau – www.novostrea.net	Hatchery	Active Commercial	NA
France	Ostrea Marinove SCEA	Le Terrain Neuf 85740 L'Epine – www.marinove.fr	Hatchery	Active Commercial	Yes
Germany	AWI Biological Institute Helgoland	Ostkaje 1118 27498 Helgoland – www.awi.de	Hatchery	Active Research	NA
Ireland	Atlantic Shellfish Ltd	Rossmore, Carrigtwohill, Co. Cork – www.oysters.co.uk	Breeding Ponds	Active Commercial	NA
Ireland	Cartron Point Shellfish Ltd	New Quay, Burren, Co. Clare	Hatchery and breeding ponds	Active Commercial	NA
Ireland	Tralee Bay Hatchery Co Ltd	The Ponds, Kilshannig Castlegregory, Tralee, Co Kerry – www.traleebayhatchery.com	Hatchery	Active Commercial	NA
The Netherlands	NIOZ Experimental Hatchery	Zuiderhaaks 18 1797 SH 't Horntje, Texel – www.nioz.nl	Hatchery	Active Research	Yes
The Netherlands	Roem van Yerseke BV	Postbus 25 4400AA Yerseke – www.roemhatchery.nl	Hatchery	Active? Commercial	NA
The Netherlands	Stichting Zeeschelp	Jacobahaven 1 4493ML Kamperland – www.zeeschelp.nl	Hatchery	Inactive Commercial	NA
Norway	Bømlo Skjell AS	Agapollen Fv22, 5420 Rubbestadneset	Breed Poll	Active Commercial	Yes
Norway	Scalpro AS	Svartevikvegen 5 Oygarden 5337 Rong	Hatchery	Active? Commercial	Yes
Norway	Storestraumen Østers AS	Innerpollen 5200 Os	Breed Poll	Active Commercial	Yes
Norway	Sunnhordland Havbruk	Mølstrevåg 5550 Sveio	Breed Poll	Active Commercial	Yes
Portugal	Marvellous Wave SA – Aquanostra®	Estrada Nacional N10, Pavilhão D22. 2910-130 Setúbal – www.aquanostra.pt	Hatchery	Active Commercial	NA

**Table 9** (continued)

Country	Name	Addresses	Production technology	Status and aim	<i>Bonamia</i> sp. free spat
Scotland, UK	FAI Farms Ardtoe Marine Research Facility	Ardtoe, Acharacle PH364LD Argyll – www.faifarms.com	Hatchery	Active? Commercial	NA
Scotland, UK	Orkney Shellfish Hatchery Ltd	Lobster Ponds, Lambholm, Orkney KW17 2RR – www.orkneyshellfishhatchery.co.uk	Hatchery	Active Commercial	NA
Spain	A Ostreira SL	Lugar del Porto de Barizo 15113 Malpica de Bergantiños La Coruña	Hatchery	Active Commercial	Yes
Spain	Centro de Cultivos Marinos de Ribadeo	Peirao de Porcillán, s/n 27700 Ribadeo Lugo	Hatchery	Active?	NA
Sweden	Ostrea Aquaculture	Hamnevägen 38 45205 Sydskoster – www.aquaculture.se	Hatchery	Active Commercial	Yes

The wild seed collection areas are not listed here. The status and production objectives are for information purposes only (last update: 11.2018). The last update of the URL links is 02.2020. NA are data not available.

†Assumption to be confirmed.

For the identification of internal parasites and pathogens, it is possible to perform a screening by sampling and destroying a few individuals for analysis (e.g. histological, PCR) or by non-destructive screening (Kamermans P, Blanco A, van Dalen P, Peene F, Engelsma M. unpublished data).

Bacterial control in *O. edulis* rearing facilities is achieved both by treatment of the water upstream using the systems mentioned above, by prophylactic management of employees, and with antibiotics or probiotics.

The most common antimicrobial agents registered in the literature of this review for water treatment of *O. edulis* were the following: Chloramphenicol (Tubiash *et al.* 1965; Jeffries 1982), Penicillin (Jeffries 1982) and Streptomycin (Tubiash *et al.* 1965). Although curative use of such agents is not prohibited, their regular preventive use is highly detrimental in hatcheries for two main reasons: the first being the risk of long-term resistance of the bacteria to the treatments, and the second being the risk of dissemination of these agents or resistant bacteria in the natural environment (Dubert *et al.* 2017).

The large-scale use of probiotics in bivalve hatcheries is recent (Prado *et al.* 2010; Goulden *et al.* 2013; Dubert *et al.* 2017). As an example, Kesarcodi-Watson *et al.* (2012) demonstrates that three strains of probiotics (*Alteromonas macleodii* 0444, *Neptunomonas* sp. 0536, *Phaeobacter gallaeciensis*) have provided significant protection against different pathogens of the genus *Vibrio*.

#### Food production

Food production in bivalve hatcheries is still mainly dependent on microalgae culture (Helm *et al.* 2004). Robert and Gérard (1999) summarizes that the quantity and quality of food varies according to the animal stages and production

must meet nutritional requirements. They indicate as follows: for larval rearing, the quantity of microalgae required is less than for other stages of production (ca. 15–20 L of microalgae at a concentration of  $6 \times 10^6$  cell mL<sup>-1</sup> per day per 10<sup>6</sup> larvae according to Muller-Feuga 1997); however, the nutritional and biological quality must be high. For broodstock conditioning, the quantity of microalgae is high (ca. 0.5–2 L of microalgae at a concentration of  $6 \times 10^6$  cell mL<sup>-1</sup> per day per oyster according to Muller-Feuga 1997) and the quality can highly influence gametogenesis.

Alternatives to microalgae are being investigated through various studies. Alternatives such as bacteria and thraustochytrids, yeasts, preserved microalgae (concentrated, refrigerated, frozen), dried or powdered microalgae, microalgal pastes, microcapsule, lipid microspheres and lipid emulsions are described in Robert and Trintignac (1997), Knauer and Southgate (1999), Brown and McCausland (2000), and Rikard and Walton (2012). These alternatives, complements or partial replacements of diet are still in an experimental stage and require optimization before large-scale use.

#### Broodstock conditioning

Broodstock conditioning of *O. edulis* is especially difficult outside the natural season, with the gonadal development being in a resting period. Thus, the time needed to obtain mature gametes is linked to the initial gonadal maturation state of the oysters. However, broodstock conditioning can be improved by regulating external factors such as temperature, photoperiod, diet quality and ration. Only a few studies have addressed the effects of these factors on flat oyster gametogenesis and conditioning. Early studies report that the duration of gametogenesis depends on water temperature (Korringa 1940; Mann 1979; Wilson & Simons 1985).

Millican and Helm (1994) showed that microalgae supplements accelerate spawning in *O. edulis* and increase the number of released larvae. More recently, the positive effect of increased photoperiod and increased temperature on gonadal development, cultch and larval production of the flat oyster during autumn and winter conditioning was reported (Maneiro *et al.* 2016; Maneiro *et al.* 2017b). Using a gradient of daylight (8–16 h) and 4 weeks of conditioning in winter at a temperature gradient of 14–18°C, a successful conditioning of *O. edulis* oysters was achieved in autumn after 10 weeks (Maneiro *et al.* 2017b) and in winter after 4 weeks (Maneiro *et al.* 2016). Total larval production was two to three times higher, while oysters under other conditioning regimes displayed a delay in the spawning process (Maneiro *et al.* 2016; Maneiro *et al.* 2017b). In contrast, Joyce *et al.* 2013 did not find any effect of photoperiod, uncoupled from temperature, on the rate or timing of gametogenesis in *O. edulis*. However, the light intensity used in these experiments was ca. 20 times lower.

Food availability but also nutritional value, size and digestibility of microalgae affect broodstock conditioning and the reproductive performance of flat oysters (Millican & Helm 1994; Maneiro *et al.* 2017a; Maneiro *et al.* 2020). A food ration equal to 6% (dry weight algae/dry weight oyster per day and per oyster) of a mixed diet of microalgae (10% *Isochrysis nuda*, 10% *Tisochrysis lutea*, 10% *Tetraselmis suecica*, 10% *Diacronema lutheri*, 25% *Skeletonema* spp., 10% *Phaeodactylum tricornerutum* and 25% *Chaetoceros* spp.) was confirmed to be effective for *O. edulis* conditioning in both autumn and winter. In addition, mortality of the broodstock remained low (Maneiro *et al.* 2017b). The value and positive effects of a mixed diet for flat oyster conditioning are reported by several authors (González-Araya *et al.* 2011; González-Araya *et al.* 2012b; Nielsen *et al.* 2016), also after analysing the physiological and biochemical performance of the larvae. A mixed diet of *Chaetoceros neogracile* and *Rhodomonas salina* also promoted a better and faster gonadal development and improved larval development (González-Araya *et al.* 2012a; González-Araya *et al.* 2013).

#### Spawning induction

In 1988, different techniques for spawning stimulation were compared for the first time, with the aim to allow the induction of triploidy: induction by chemical, thermal and biological stimuli (Gendreau 1988). Gendreau reports that induction by chemical (serotonin) stimuli caused an emission of a few dozen non-viable oocytes, induction by thermal stimuli only triggered the emission of male gametes and the induction by biological stimuli induced the laying of mature female oysters. The resulting protocol therefore is divided into two parts in order to obtain all gametes, male and female, necessary for fertilization. Thermal stimuli are implemented by successive variations in seawater temperature

between 16 and 25°C in which oysters are immersed during a 1-h period. Biological stimuli consist of the addition of male/female gametes of marine bivalves (e.g. *O. edulis*, *C. gigas*), which were previously destroyed by ultrasound, into the water of the broodstock tank. Also, for polyploidy induction purposes, a similar thermal shock was performed for the induction of spawning (Hawkins *et al.* 1994).

#### First attempts of artificial fertilization

The bibliographic search identified two descriptions of artificial fertilization methods in the work of Gendreau (1988) and Hawkins *et al.* (1994).

After the induction of the female spawning, the emissions of some oocytes from the valves are carefully observed and as soon as they are detected the designated oyster is sacrificed, opened and the oocytes are collected immediately with the use of a pipette (Gendreau 1988). The oocytes are then pooled and sieved in order to remove faeces and other miscellaneous debris. Afterwards, they are counted and fertilized with spermatozeugmata present in the dissociation phase. A ratio of spermatozoa to oocytes between 5 and 10 should be applied to avoid the phenomenon of polyspermy. The survival rate of the larvae between fertilization and the day before metamorphosis was 10%.

Hawkins *et al.* (1994) sacrifices all broodstock immediately after spawning induction in order to remove male and female gametes. The ratio of spermatozoa to oocytes applied here is 50:1 at a fertilization temperature of 20°C. The survival rate is not reported in this study.

#### Cryopreservation

Cryopreservation of oyster gametes, embryos and larvae is of high relevance and of future interest for aquaculture and for restoration as it provides several advantages: saving time and space for broodstock conditioning operations including food production, possibly influencing genetic diversity via cryopreserved gametes during controlled breeding, developing genetic selection programmes or protecting endangered species strains.

The bibliographic search identified two studies in this relatively new field, conducting cryopreservation research on sperm and larvae of *O. edulis* (Vitiello *et al.* 2011; Horváth *et al.* 2012). The chronological cryopreservation operations are described in Appendix S4.

Horváth *et al.* (2012) stated that although the motility results are poor, sperm survival rates were relatively high and suggested further fertilization tests to confirm the effectiveness and performance of male gamete cryopreservation.

Additionally, Horváth *et al.* (2012) investigated the cryopreservation of trochophore and veliger larvae. After concentrating the larvae to a density of 800 larvae mL<sup>-1</sup> in



filtered water and adding 5–20% dimethyl sulfoxide, freezing and thawing were carried out with a similar method. Two conclusions seem evident: More advanced stages of larvae appear more resistant to the cryoprotective toxicity and cryopreservation survival than earlier stages. As larval survival 24 h after thawing was zero, further research is required to establish this technique.

#### Larvae collection and larval rearing

Although the above-mentioned trials are at the experimental stage, today, hatchery production of *O. edulis* is carried out by natural swarming and collection of larvae by overflowing the rearing water into a second tank equipped with a sieve (ca. 90–150 µm) that retains the larvae (Fig. 8; Helm *et al.* 2004).

Hatchery larval density varies in the literature of this review between one and nine larvae per millilitre in the water of rearing tanks (flow-through systems and static water systems; Walne 1974; Helm *et al.* 2004; González-Araya *et al.* 2012b). However, in the same flow-through structures as González-Araya *et al.* 2012b, rearing of *C. gigas* larvae at a concentration of 150 larvae per millilitre was successfully tested (Asmani *et al.* 2017), suggesting that increasing larval densities may be possible.

Within Anonymous (2014), monitoring of *Vibrionaceae* bacterial load is conducted during the broodstock conditioning period, the spawning and brooding period, as well as during the larval phase. The maximum thresholds recommended in the water of the rearing tanks during these three phases are, respectively: 500 bacteria per millilitre, 500 bacteria per millilitre and 3 bacteria per *O. edulis* larvae.

The influence of aeration rate in rearing tanks on *O. edulis* embryos and larvae was investigated in Helm and Spencer (1972).

The influence of the ration, regime and diet of *O. edulis* larvae was investigated by Lane (1989), Millican and Helm (1994), Marshall *et al.* (2010), Acarli (2011), González-Araya (2012), Robert *et al.* (2017) and González-Araya and Robert (2018).

#### Metamorphosis

Settlement and metamorphosis are essential steps in hatchery production, which are regulated by external chemical factors and physical cues (Hadfield *et al.* 2001).

Larval mortalities occurring during settlement can be related to contamination, for example by bacteria (González-Araya *et al.* 2012b). *O. edulis* is susceptible to *B. ostreae* infection prior to metamorphosis. Larval survival of these early stages increases with reduced exposure of oyster larvae to external, contaminated environments and with usage of uninfected broodstock (Flannery *et al.* 2014; Flannery *et al.* 2016). As an alternative to the use of antibiotics in hatchery, new approaches to control bacterial infections were developed using probiotics (Prado *et al.* 2009). A low pH was also found to reduce bacterial growth and therefore increase the survival of veliger and pediveliger larvae (Prado *et al.* 2016).

The regulation of external factors allows high levels of competence and settlement. Robert *et al.* (2017) recommended a temperature of 25°C and a bispecific microalgal diet (*C. neogracile* and *T. lutea*) for survival rates of up to 99% and high settlement rates (68%).

Competent larvae can be induced to settle and metamorphose by functional analogues of the natural inducers. Several studies have been carried out testing these chemical analogues on flat oysters. GABA (Gamma aminobutyric acid) and epinephrine have been reported to improve larval settlement and metamorphosis under laboratory and hatchery conditions without affecting the survival of the

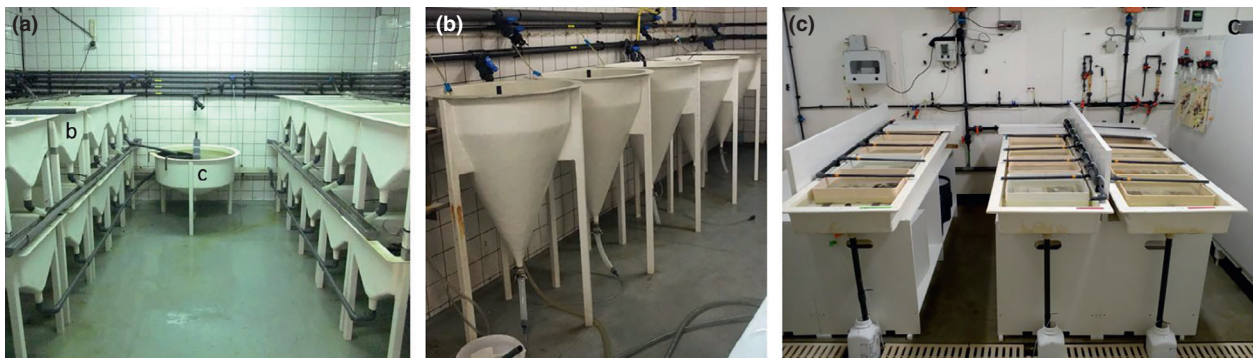

**Figure 8** Yerseke Hatchery (a,b) and Argenton Hatchery (c): pictures of three phases of hatchery production. (a) Broodstock conditioning room with (b) the broodstock tanks and (c) the larval collection tank by overflow of water from the tanks (b). (b) Larval culture rooms with cylindrical-conical basins. (c) Larval settlement room with flat-bottomed sieves in three rearing tanks. Photographs from Bérenger Colsoul.

larvae (García-Lavandeira *et al.* 2005; Mesías-Gansbiller *et al.* 2013).

In aquaculture, for marketing reasons such as the appearance and shape of the shell (Mizuta & Wikfors 2018), mechanization, reduction of transport and operating costs; the production of cultchless spat was developed. Aside from the settlement of *O. edulis* larvae on micro-cultch, Hidu *et al.* (1975) have also investigated the use of polished marble in hatchery. Although Hidu reports that the substrate is very attractive for the larvae, a persistent problem of this technique is the survival of spat after their removal from the substrate and the damage the removal technique inflicts.

#### Remote setting

The marketing of eyed oyster larvae for subsequent settlement, also called remote setting, is a technique developed in the late 1970s on cupped oysters by American commercial hatcheries and introduced to Europe (France) in 1987. In 1989, 90% of oyster production on the west coast of the USA and in Canada came from seed produced by this technique (Guesdon *et al.* 1989). In Europe, remote setting was relevant for *C. gigas* production in the past; today, this technique is almost abandoned.

In France, Guesdon *et al.* (1989

), Carbonnier *et al.* (1990) and Coatanea *et al.* (1992) tested remote setting on flat oysters. Remote setting is a seed collection technique, controlled and carried out by producers in their facilities using eye larvae ready to settle that are provisioned by hatcheries. The principle of the method is therefore to split the work of hatcheries and producers, leaving hatcheries with the sole task of producing larvae.

The major potential interest in aquaculture is to obtain seed at a lower cost than from a hatchery by pre-growing the seed in a land-based structure. For restoration, the main interest here is the non-dependence on owning and operating a hatchery and the potential of growing larvae as early as possible in the water body of the respective restoration operation.

There are advantages and disadvantages of hatchery seed over wild seed. Here are some arguments in favour of hatchery seed: control of collection density per collector, control of breeding cycles (shift or shorten: season independence), control of homogeneity in size and distribution of seed on collectors, choice of collector or settlement substrate, selection of broodstock (e.g. allowing genetic selection or diversity) and potential control of pathogens and predators. The limitation of detaching operations for aquaculture purposes should also be considered: detaching can be mechanized on certain collector types and the use of cultch eliminates detaching.

The three studies indicate that remote setting is feasible but requires numerous optimizations, notably in larval transport and survival before obtaining a transferable protocol for seed producers. To this end, it is important to note that the influence of starvation on *O. edulis* larvae was investigated in the four following studies: Millar and Scott (1967), Holland and Spencer (1973), Robert *et al.* (1988) and Labarta *et al.* (1999). In addition, Millar and Scott (1967) reported that no mortality was observed in recently swarmed larvae for a period of several days.

A summary of these remote setting operations for *O. edulis* found in the above cited trials is provided in Appendix S5.

#### Conclusions

Ecological restoration of the European flat oyster has great potential in the frame of large-scale marine nature conservation initiatives. Restoration projects and programmes are being established in a number of European countries. Currently, the production of seed oysters (details on the terminology used are provided in Appendix S6) in both, high quality and quantity, presents a limiting factor (Pogoda *et al.* 2019). The existing knowledge on the biological background and current production technologies, relevant for successful production and tailored to the specific needs of restoration, are integrated here to provide implications for restoration, further challenges and open questions.

#### Implications for restoration and further challenges

As commercial production of *O. edulis* was driven by aquaculture demands so far, and has clearly shifted to *C. gigas* production in general, revived traditional techniques and modern approaches of sustainable production need to be synchronized, tested and developed to meet the demands of ecological restoration.

One notable example is the consideration of *O. edulis* seed production in breed polls in order to better understand the performance and potential future developments of this technique, both for ecological restoration and aquaculture. This particular technique, used only in Norway so far, should also be assessed in other regions. Next to breed polls, custom-built breeding ponds have many advantages and are gaining interest due to the new demands by restoration initiatives. The mechanization of livestock operations in accordance with the production-cost ratio as well as the monitoring and automated management of zootechnical parameters such as temperature will optimize and promote the application of breeding ponds. However, although their size is usually limited, the development of breed polls and breeding ponds may encounter limitations from environmental restrictions, limited appropriate sites

and constrained access to coastal areas. The variable success in seed production as well as the current intense work routine going along with these facilities also limits the interest in these systems by new producers. Breeding pond technique, although being successful and the focus of scientific research for 40 years, for example at the Conwy Fisheries Laboratory, was neglected in favour of hatchery production (Walne 1974; Spencer 2008). A comeback of this approach seems ecologically reasonable and should be encouraged.

Current hatchery production techniques still encounter knowledge gaps and challenges in broodstock management and the setting of optimum conditioning parameters. Further challenges include the choice of adult broodstock oysters. The implementation of selection programmes focusing on strains tolerant to specific diseases and adapted to site-specific environments on the one hand, and preserving a high genetic diversity of restored *O. edulis* populations on the other hand is of major importance (Pogoda *et al.* 2020; zu Ermgassen *et al.* 2020a).

In the past, declining oyster stocks were substituted by translocation or introduction of new stocks for fishery and aquaculture (Roché 1898; Korringa 1946; Bromley *et al.* 2016a). Ecological restoration of *O. edulis* is relatively recent and aims at ecosystem function and recovery. Major challenges related to genetic aspects are to avoid transfers of pathogens and diseases, to achieve sustainable survival rates and to retain a high genetic diversity (Hughes *et al.* 2008; Lallias *et al.* 2010).

Maintaining genetic diversity within the natural population, genetic improvement of a population facing low genetic diversity and the creation of a genetically diverse pool in the event of a reintroduction of the species are important aspects that have to be considered for seed oyster production (Gaffney 2006; Pogoda *et al.* 2019), for example via the joint development and implementation of best practice, involving research, conservation policy and industry. Seed production methods make a difference for the genetic diversity as described by Lallias *et al.* (2010) and resumed here: (i) Large-scale production techniques in breed polls and breeding ponds achieve an increased genetic diversity compared with hatcheries; (ii) In *Bonamia*-free areas, large-scale productions in breed polls and breeding ponds are therefore relevant technologies; (iii) In areas where bonamiosis is present, the use of resistant or tolerant strains is an important alternative.

In summary, the adaptation and improvement of hatchery and breeding pond techniques could increase genetic diversity in produced seed oysters (Saavedra 1997).

#### Open questions and proposed research topics

A number of open research questions remain to be addressed, both on the fundamental aspects of

ecophysiology, as well as on the basic biology of oysters, focusing on the development of new applications for seed production:

- (1) The sex determinism and the understanding of factors leading to sex change are still poorly understood. No research projects investigated the regulation or control of this reproduction phase. However, managing the sex ratio of broodstock is a relevant tool to increase *O. edulis* seed production.
- (2) A deeper understanding of the mechanisms of gametogenesis would allow controlling or synchronizing the onset of gametogenesis. This would facilitate production planning in hatcheries, as well as the management of spawning and swarming periods in semi-controlled environments such as breeding ponds. In addition, a reliable protocol for induction of settlement, synchronization and successful metamorphosis should be provided.
- (3) Cryopreservation of gametes and embryos is a promising technique for the development of oyster aquaculture and conservation of genetic resources in the near future, but the method needs to be investigated and established thoroughly. The use of cryopreserved gametes would require to develop artificial fertilization larval rearing methods.
- (4) Further research on the role of alternative nutrition will clarify and define the impact of nanoplankton and picoplankton such as bacteria, detritus or dissolved organic matter, which seems to influence oyster growth, but has not been investigated in *O. edulis* so far.
- (5) No commercial-scale selective breeding programme currently exists despite the possibility to select certain strains resistant to known pathogens, such as *B. ostreae*. Investigating the impact of different production systems of selected strains on the genetic variability of natural populations will be needed for the long-term success of oyster restoration in the future.
- (6) Pathogens and diseases affecting *O. edulis* are numerous, and their ranges may shift in the future. Although many governmental and international regulations exist, transfers of marine invertebrates across Europe and the world as well as the transfer of substrate and seawater (ballast) still exist. Different climatic conditions will affect the spread and intensity of diseases. Respective consequences for *O. edulis* production need to be investigated.
- (7) As sea-based seed collection is an important seed production technique, the effects of climate change on reproductive patterns and potential of wild populations should be evaluated further.

- (8) Many aspect related to breeding pond production must be (re)investigated, for example why production in some ponds fail when adjacent ponds are successful.

## Acknowledgements

We thank the German Federal Agency for Nature Conservation (BfN) for funding and implementing the projects RESTORE (FKZ 3516892001) and PROCEED (FKZ 3517685013 supported by the Federal Agency for Nature Conservation with funds from the Federal Ministry for the Environment, Nature Conservation and Nuclear Safety within the Federal Program for Biological Diversity) in close cooperation. We thank the staff of the AWI library for their constant support and the following colleagues for their help throughout the supervision of this study, the analysis and the writing stages: Karen Wiltshire, Maarten Boersma, Henning von Nordheim. We would also like to thank all those who have helped in any way by providing bibliographic material, comments, suggestions and corrections. Open access funding enabled and organized by ProjektDEAL.

## References

- Aase H, Misund OA, Pedersen T (1986) Predation of oyster larvae by *Aurelia aurita* in a Norwegian oyster pond. Anonymous, In: *ICES CM Document F:21*, pp. 1–16. International Council for the Exploration of the Sea, Copenhagen.
- Abollo E, Ramilo A, Casas SM, Comesaña P, Cao A, Carballal MJ *et al.* (2008) First detection of the protozoan parasite *Bonamia exitiosa* (Haplosporidia) infecting flat oyster *Ostrea edulis* grown in European waters. *Aquaculture* **274**: 201–207.
- Acarli S (2011) Comparison of *Isochrysis galbana* and *Chlorella sp.* microalgae on growth and survival rate of European flat oyster (*Ostrea edulis*, Linnaeus 1758) larvae. *Indian Journal of Geo-Marine Sciences* **40**: 55–58.
- Acarli S, Lok A (2009) Larvae development stages of the European flat oyster (*Ostrea edulis*). *Israeli Journal of Aquaculture-Bamidgeh* **61**: 114–120.
- Alagarwami K (1982) Review on controlled breeding of bivalves of aquaculture importance. In: Subramoniam T, Varadarajan S (eds) *Progress in Invertebrate Reproduction and Aquaculture: Proceedings of the 1st All-India Symposium on Invertebrate Reproduction*, pp. 194–202. Indian Society of Invertebrate Reproduction, Madras.
- Alderman DJ, Gras P (1969) “Gill disease” of Portuguese oysters. *Nature* **224**: 616.
- Allee WC, Emerson AE, Park O, Park T, Schmidt KP (1949) *Principles of Animal Ecology*. Saunders Co., Philadelphia, PA.
- Alpbaz A, Temelli B (1997) A review of the molluscan fisheries of Turkey. In: MacKenzie CL, Burrell VG, Rosenfield A, Hobart WL (eds) *The History, Present Condition, and Future of the Molluscan Fisheries of North and Central America and Europe*, pp. 227–232. Scientific Publications Office, NMFS, NOAA, Seattle, WA.
- Alzieu C, Thibaud Y, Héral M, Boutier B (1980) Evaluation des risques dus à l’emploi des peintures anti-salissures dans les zones conchylicoles [Estimation of the dangers caused by the use of antifouling paints in the growing oyster areas]. *Revue des Travaux de l’Institut des Pêches Maritimes* **44**: 305–348.
- Anonymous (2006a) Council Directive 2006/88/EC of 24 October 2006 on animal health requirements for aquaculture animals and products thereof, and on the prevention and control of certain diseases in aquatic animals. [Cited 01 Mar 2019.] Available from URL: <http://data.europa.eu/eli/dir/2006/88/oj>
- Anonymous (2006b) *Cultured aquatic species information programme: Ostrea edulis (Linnaeus, 1758)*. [Cited 01 Dec 2019.] Available from URL: [http://www.fao.org/fishery/culturedspecies/Ostrea\\_edulis/en](http://www.fao.org/fishery/culturedspecies/Ostrea_edulis/en).
- Anonymous (2008) *SeaLifeBase*. [Cited 01 May 2008.] Available from URL: [www.sealifebase.org](http://www.sealifebase.org).
- Anonymous (2011) Vågstrandapollen – Norways best oyster poll. Anonymous, In: *RO Commercial Brochure*, pp. 1–20. Royal Oyster AS, Blomsterdalen.
- Anonymous (2014) Programme d’expérimentation et de recherche sur l’huitre plate *Ostrea edulis*. Rapport final de l’ensemble du projet 2011–2014 [Program of experimentation and research on the flat oyster *Ostrea edulis*. Final Report 2011–2014]. PERLE, pp. 1–207. Comité Régional Conchyliculture Bretagne Nord, Morlaix, France.
- Anonymous (2018) *IFREMER genetic and pathology laboratory*. Important pathogens and parasites of molluscs. [Cited 01 Aug 2018.] Available from URL: [www.eurl-mollusc.eu](http://www.eurl-mollusc.eu).
- Anonymous (2020a) *CuanBeo Newsletter: native oyster restoration in full swing in Galway Bay*. [Cited 01 Nov 2020.] Available from URL: [www.cuanbeo.com](http://www.cuanbeo.com).
- Anonymous (2020b) *ENORI essex native oyster restoration initiative*. [Cited 01 Nov 2020.] Available from URL: [www.essexnativeoyster.com](http://www.essexnativeoyster.com).
- Anonymous (2020c) *Fal fishery cooperative CIC/cornish native oysters*. [Cited 01 Nov 2020.] Available from URL: [www.savingester.co.uk](http://www.savingester.co.uk).
- Anonymous (2020d) *Loch Ryan native oysters*. [Cited 01 Nov 2020.] Available from URL: [www.oysters.co.uk](http://www.oysters.co.uk).
- Arzul I, Gagnaire B, Bond C, Chollet B, Morga B, Ferrand S *et al.* (2009) Effects of temperature and salinity on the survival of *Bonamia ostreae*, a parasite infecting flat oysters *Ostrea edulis*. *Diseases of Aquatic Organisms* **85**: 67–75.
- Arzul I, Langlade A, Chollet B, Robert M, Ferrand S, Omnes E *et al.* (2011) Can the protozoan parasite *Bonamia ostreae* infect larvae of flat oysters *Ostrea edulis*? *Veterinary Parasitology* **179**: 69–76.
- Arzul I, Miossec L, Blanchet E, Garcia C, François C, Joly JP (2006) *Bonamia ostreae* and *Ostrea edulis*: a stable host-parasite system in France? Proceedings of the 11th International Symposium for Veterinary Epidemiology and Economics, pp. 1–5. Cairns, Australia.

- Asmani K, Petton B, Le Grand J, Mounier J, Robert R, Nicolas JL (2017) Determination of stocking density limits for *Crassostrea gigas* larvae reared in flow-through and recirculating aquaculture systems and interaction between larval density and biofilm formation. *Aquatic Living Resources* **30**: 1–13.
- Auby I, Maurer D (2004) Etude de la reproduction de l'huître creuse dans le Bassin d'Arcachon [Study of the reproduction of oysters in the Arcachon Basin]. *IFREMER Report R.INT.DEL/AR 04-05*, pp. 1–203. French Research Institute for Exploitation of the Sea, Arcachon, France.
- Azevedo C, Montes J, Corral L (1999) A revised description of *Haplosporidium armoricum*, parasite of *Ostrea edulis* L. from Galicia, northwestern Spain, with special reference to the spore-wall filaments. *Parasitology Research* **85**: 977–983.
- Balouet G, Poder M, Cahour A, Auffret M (1986) Proliferative hemocytic condition in European flat oysters (*Ostrea edulis*) from Breton coasts: a 6-year survey. *Journal of Invertebrate Pathology* **48**: 208–215.
- Bamford DR, Gingles R (1974) Absorption of sugars in the gill of the Japanese oyster, *Crassostrea gigas*. *Comparative Biochemistry and Physiology* **49A**: 637–646.
- van Banning P (1977) *Minchinia armoricana* sp. nov. (Haplosporida), a parasite of the European flat oyster, *Ostrea edulis*. *Journal of Invertebrate Pathology* **30**: 199–206.
- van Banning P (1979a) Haplosporidian diseases of imported oysters, *Ostrea edulis*, in Dutch estuaries. *Marine Fisheries Review* **41**: 8–18.
- van Banning P (1979b) Protistan parasites observed in the European flat oyster (*Ostrea edulis*) and the cockle (*Cerastoderma edule*) from some coastal areas of the Netherlands. *Haliotis* **8**: 33–37.
- van Banning P (1987) Further results of the *Bonamia ostreae* challenge tests in Dutch oyster culture. *Aquaculture* **67**: 191–194.
- Barthélemy-Saint Hilaire J (1887) *Traité de la Génération des Animaux, Volume 1, Oeuvres d'Aristote*. Hachette et Cie, Paris.
- Baud JP, Gérard A, Naciri-Graven Y (1997) Comparative growth and mortality of *Bonamia ostreae*-resistant and wild flat oysters, *Ostrea edulis*, in an intensive system. I. First year of experiment. *Marine Biology* **130**: 71–79.
- Bayne BL (2017) *Biology of Oysters. Developments in Aquaculture and Fisheries Science*, Vol. **41**. Elsevier Science, Academic Press, London.
- Beaulieu M (1890) Letter on oyster culture. *Journal of the Marine Biological Association of the United Kingdom* **1**: 282–285.
- Benovic A (1997) The history, present condition, and future of the molluscan fisheries of Croatia. In: MacKenzie CL, Burrell VG, Rosenfield A, Hobart WL (eds) *The History, Present Condition, and Future of the Molluscan Fisheries of North and Central America and Europe*, pp. 217–226. Scientific Publications Office, NMFS, NOAA, Seattle, WA.
- Berthe FCJ, Le Roux F, Adlard RD, Figueras A (2004) Marteiliosis in molluscs: a review. *Aquatic Living Resources* **17**: 433–448.
- Bøhle B (1984) Østers og østerskultur i Norge. Utnyttning av østerspoller på Skagerrakkysten [Oysters and oyster culture in Norway. Exploitation of oyster polls on the Skagerrak Coast]. Anonymous, In: *Flødevigen Meldinger* **6**, pp. 1–23. Institute of Marine Research, Arendal.
- Bougrier S, Tige G, Bachere E, Grizel H (1986) *Ostrea angasi* acclimatization to French coasts. *Aquaculture* **58**: 151–154.
- Bower SM, Hervio D, Meyer GR (1997) Infectivity of *Mikrocytos mackini*, the causative agent of Denman Island disease in Pacific oysters *Crassostrea gigas*, to various species of oysters. *Diseases of Aquatic Organisms* **29**: 111–116.
- Bracke E, Polk P (1969) Contribution à la connaissance de la faune marine de la côte belge [Contribution to the knowledge of the marine fauna of the Belgian coast]. *Hydrobiologia* **34**: 100–125.
- Bratoš A, Bolotin J, Peharda M, Njire J (2002) Seasonal distribution of the oyster *Ostrea edulis* (Linnaeus, 1758) larvae in the bay of Mali Ston, Adriatic Sea. *Journal of Shellfish Research* **21**: 763–767.
- Bratoš A, Glamuzina B, Benović A (2004) Croatian shellfisheries aquaculture - advantages and disadvantages. *Naše More* **51**: 59–62.
- Bratoš Cetinić A, Bolotin J (2016) Uzgoj školjkaša u Malostonskom zaljevu [Shellfish farming in the Bay of Mali Ston]. In: Radić Z (ed.) *More Hrvatsko Blago*, pp. 888–899. Zagreb, Croatia.
- Brenner M, Fraser D, Van Nieuwenhove K, O'Beirn F, Buck BH, Mazurie J et al. (2014) Bivalve aquaculture transfers in Atlantic Europe. Part B: Environmental impacts of transfer activities. *Ocean & Coastal Management* **89**: 139–146.
- van den Brink A, Magnesen T (2018) Treatment protocol flat oysters with Norwegian oysters. *Wageningen University and Research (Report in Mimeo)*, pp. 1–9.
- Bromley C, McGonigle C, Ashton EC, Roberts D (2016a) Bad moves: Pros and cons of moving oysters – a case study of global translocations of *Ostrea edulis* Linnaeus, 1758 (Mollusca: Bivalvia). *Ocean & Coastal Management* **122**: 103–115.
- Bromley C, McGonigle C, Ashton EC, Roberts D (2016b) Restoring degraded European native oyster, *Ostrea edulis*, habitat: is there a case for harrowing? *Hydrobiologia* **768**: 151–165.
- Brooks WK (1879) Abstract of observations upon the artificial fertilization of oyster eggs, and on the embryology of the American oyster. *American Journal of Science* **18**: 425–427.
- Brown MR, McCausland MA (2000) Increasing the growth of juvenile Pacific oysters *Crassostrea gigas* by supplementary feeding with microalgal and dried diets. *Aquaculture Research* **31**: 671–682.
- Bruce JR, Knight M, Parke MW (1940) The rearing of oyster larvae on an algal diet. *Journal of the Marine Biological Association of the United Kingdom* **24**: 337–374.
- Buestel D, Ropert M, Prou J, Gouilletquer P (2009) History, status, and future of oyster culture in France. *Journal of Shellfish Research* **28**: 813–820.
- Burke K, Bataller É, Miron G (2008a) Spat collection of a non-native bivalve species (European oyster, *Ostrea edulis*) off the

- eastern Canadian coast. *Journal of Shellfish Research* **27**: 345–353.
- Burke K, Battaller É, Miron G, Ouellette M, Tremblay R (2008b) Larval quality of a nonnative bivalve species (European oyster, *Ostrea edulis*) off the east Canadian coast. *Journal of Shellfish Research* **27**: 701–710.
- Buroker NE (1985) Evolutionary patterns in the family Ostreidae: Larviparity vs. oviparity. *Journal of Experimental Marine Biology and Ecology* **90**: 233–247.
- Calabrese A, MacInnes JR, Nelson DA, Miller JE (1977) Survival and growth of bivalve larvae under heavy-metal stress. *Marine Biology* **41**: 179–184.
- Cano J, Rosique MJ, Rocamora J (1997) Influence of environmental parameters on reproduction of the European flat oyster (*Ostrea edulis* L.) in a coastal lagoon (Mar Menor, southeastern Spain). *Journal of Molluscan Studies* **63**: 187–196.
- Carbonnier N, Martin AG, Mazurie J, Barthelemy G, Le Mouroux G, Martin AG *et al.* (1990) Télécaptage de l'huître plate : travaux réalisés en 1990 [Remote setting of the flat oyster: work carried out in 1990]. Anonymous, In: *Section Régionale de Bretagne Sud: Plan de Relance de l'Huître Plate 1990*, pp. 1–97. CIC-IFREMER, Auray.
- Carlucci R, Sassanelli G, Matarrese A, Giove A, D'Onghia G (2010) Experimental data on growth, mortality and reproduction of *Ostrea edulis* (L., 1758) in a semi-enclosed basin of the Mediterranean Sea. *Aquaculture* **306**: 167–176.
- Carrasco N, Green T, Itoh N (2015) *Marteilia* spp. parasites in bivalves: a revision of recent studies. *Journal of Invertebrate Pathology* **131**: 43–57.
- Casas SM, Grau A, Reece KS, Apakupakul K, Azevedo C, Villalba A (2004) *Perkinsus mediterraneus* n. sp., a protistan parasite of the European flat oyster *Ostrea edulis* from the Balearic Islands, Mediterranean Sea. *Diseases of Aquatic Organisms* **58**: 231–244.
- Casas SM, Reece KS, Li Y, Moss JA, Villalba A, La Peyre JF (2008) Continuous culture of *Perkinsus mediterraneus*, a parasite of the European flat oyster *Ostrea edulis*, and characterization of its morphology, propagation, and extracellular proteins in vitro. *Journal of Eukaryotic Microbiology* **55**: 34–43.
- Castanos C, Pascual MS, Agulleiro I, Zampatti E, Elvira M (2005) Brooding pattern and larval production in wild stocks of the puelche oyster, *Ostrea puelchana* d'Orbigny. *Journal of Shellfish Research* **24**: 191–196.
- Chaparro OR, Mardones-Toledo DA, Gray MW, Cubillos VM, Navarro JM, Salas-Yanquin LP (2018) Female–embryo relationships in *Ostrea chilensis*: brooding, embryo recognition, and larval hatching. *Marine Biology* **166**: 10.
- Clewell AF, Aronson J (2013) *Ecological Restoration: Principles, Values, and Structure of an Emerging Profession*. Island Press, Washington, DC.
- Coatanea D, Oheix J, Mazzara L, Hamon PY (1992) Essais de télécaptage de l'huître plate *Ostrea edulis* en Méditerranée: Bilan 1991 [Remote setting trials of the flat oyster *Ostrea edulis* in the Mediterranean: Review 1991]. *IFREMER Report RIDRV-92.021 RA*, pp. 1–63. French Research Institute for Exploitation of the Sea, Palavas-les-Flots, France.
- Coatanea D, Vercelli C, Chabirand JM, Oheix J, Pichot Y, Hirata T (1996) Contrôle de la maturation et du calendrier d'émission larvaire d'un stock de géniteurs d'huîtres plates *Ostrea edulis* méditerranéennes. Rapport final [Control of the maturation and larval release schedule of a broodstock of Mediterranean flat oyster *Ostrea edulis*. Final report]. *IFREMER Report LR Nr. 94.3.522.0011F*, pp. 1–125. French Research Institute for Exploitation of the Sea, Palavas-les-Flots, France.
- Coen LD, Luckenbach MW (2000) Developing success criteria and goals for evaluating oyster reef restoration: ecological function or resource exploitation? *Ecological Engineering* **15**: 323–343.
- Cole HA (1937) Experiments in the breeding of oysters (*Ostrea edulis*) in tanks, with special reference to the food of the larva and spat. Anonymous, In: *Fishery Investigations Series II*, pp. 1–18. Her Majesty's Stationery Office, London.
- Cole HA (1941) The fecundity of *Ostrea edulis*. *Journal of the Marine Biological Association of the United Kingdom* **25**: 243–260.
- Cole HA (1942) Primary sex-phases in *Ostrea edulis*. *Journal of Cell Science* **83**: 317–356.
- Cole HA, Knight Jones EW (1949) The setting behaviour of larvae of the European flat oyster *Ostrea edulis* L., and its influence on methods of cultivation and spat collection. Anonymous, In: *Fishery Investigations Series II*, pp. 1–39. Her Majesty's Stationery Office, London.
- Colsoul B, Pouvreau S, Di Poi C, Pouil P, Merk V, Peter C *et al.* (2020) Addressing critical limitations of oyster (*Ostrea edulis*) restoration: identification of nature-based substrates for hatchery production and recruitment in the field. *Aquatic Conservation: Marine and Freshwater Ecosystems* **30**: 2101–2115.
- Comps M, Cochennec N (1993) A herpes-like virus from the European oyster *Ostrea edulis* L. *Journal of Invertebrate Pathology* **62**: 201–203.
- Connellan I (1995) *Shellfish Hatchery Design with Notes on Spating Ponds for Aquaculture Students*. Galway-Mayo Institute of Technology, Galway, Ireland.
- Connor PM (1972) Acute toxicity of heavy metals to some marine larvae. *Marine Pollution Bulletin* **3**: 190–192.
- Corlay JP (2001) Voyage d'exploration sur le littoral de la France et de l'Italie (Victor Coste, 1861), ou Prométhée au pays d'*Ostrea* [A voyage of exploration on the coasts of France and Italy (Victor Coste, 1861), or Prometheus in the Land of *Ostrea*]. *Les Cahiers Nantais* **55**: 289–307.
- Coste JMCV (1861) Industrie du lac Fusaro - Bancs artificiels d'huîtres [Industry of the Fusaro Lake – Artificial oyster banks]. In: Coste JMCV (ed.) *Voyage d'Exploration sur le Littoral de la France et de l'Italie*, pp. 89–106. Imprimerie Impériale, Paris.
- Cragg SM, Gruffydd LLD (1975) The swimming behaviour and the pressure responses of the veliconcha larvae of *Ostrea edulis* (L.). In: Barnes HB (ed.) *Proceedings of the 9th European Marine Biology Symposium*, pp. 43–57. Aberdeen University Press, Aberdeen.

- Cranfield HJ (1973) Observations on the behaviour of the pediveliger of *Ostrea edulis* during attachment and cementing. *Marine Biology* **22**: 203–209.
- Crawford C (2016) National review of *Ostrea angasi* aquaculture: historical culture, current methods and future priorities. *Contract Report of the University of Tasmania*, pp. 1–44. Institute for Marine and Antarctic Studies, University of Tasmania, Hobart, TAS.
- Culloty SC, Mulcahy MF (1992) An evaluation of anaesthetics for *Ostrea edulis* (L.). *Aquaculture* **107**: 249–252.
- Culloty SC, Mulcahy MF (2007) *Bonamia ostreae* in the native oyster *Ostrea edulis*. A review. Anonymous, In: *Marine Environment and Health Series No. 29*, pp. 1–40. Marine Institute, Ireland.
- Dantan JL, Perrier E (1913) La fécondité de l'*Ostrea edulis* (L.). [The fecundity of the *Ostrea edulis* (L.)]. *Comptes Rendus Hebdomadaires des Séances de l'Académie des Sciences* **157**: 871–873.
- Davaine C (1853) *Recherches sur la Génération des Huîtres*. E. Thunot et Cie, Paris.
- Davenel A, González R, Suquet M, Quellec S, Robert R (2010) Individual monitoring of gonad development in the European flat oyster *Ostrea edulis* by *in vivo* magnetic resonance imaging. *Aquaculture* **307**: 165–169.
- Davis HC, Ansell AD (1962) Survival and growth of larvae of the European oyster, *O. edulis*, at lowered salinities. *The Biological Bulletin* **122**: 33–39.
- Davis HC, Calabrese A (1969) Survival and growth of larvae of the European oyster (*Ostrea edulis* L.) at different temperatures. *The Biological Bulletin* **136**: 193–199.
- Dean B (1890) The present methods of oyster-culture in France. *Bulletin of the United States Fish Commission* **10**: 363–398.
- Dean B (1891) Report on the European methods of oyster-culture. *Bulletin of the United States Fish Commission* **11**: 357–406.
- Diaz-Almela E, Boudry P, Launey S, Bonhomme F, Lapègue S (2004) Reduced female gene flow in the European flat oyster *Ostrea edulis*. *Journal of Heredity* **95**: 510–516.
- Dodgson RW (1922) Noctiluca as an enemy of the oyster. *Nature* **110**: 343–344.
- Dollfus RP (1921) Résumé de nos principales connaissances pratiques sur les maladies et les ennemis de l'huître [Summary of our main practical knowledge on oyster diseases and enemies]. *Notes et Mémoires* **7**: 1–51.
- Downing SL, Allen SK (1987) Induced triploidy in the Pacific oyster, *Crassostrea gigas*: optimal treatments with cytochalasin B depend on temperature. *Aquaculture* **61**: 1–15.
- Dubert J, Barja JL, Romalde JL (2017) New insights into pathogenic vibrios affecting bivalves in hatcheries: present and future prospects. *Frontiers in Microbiology* **8**: 1–16.
- Dupuy JL, Windsor NT, Sutton CE (1977) Manual for design and operation of an oyster seed hatchery for the American oyster *Crassostrea Virginica*. Special Report No. 142 in Applied Marine Science and Ocean Engineering, pp. Virginia Institute of Marine Science, Gloucester Point, Virginia, USA.
- Eagling LE, Ashton EC, Jensen AC, Sigwart JD, Murray D, Roberts D (2018) Spatial and temporal differences in gonad development, sex ratios and reproductive output, influence the sustainability of exploited populations of the European oyster, *Ostrea edulis*. *Aquatic Conservation: Marine and Freshwater Ecosystems* **28**: 1–12.
- Engelsma MY, Culloty SC, Lynch SA, Arzul I, Carnegie RB (2014) *Bonamia* parasites: a rapidly changing perspective on a genus of important mollusc pathogens. *Diseases of Aquatic Organisms* **110**: 5–23.
- Engelsma MY, Kerkhoff S, Roozenburg I, Haenen OLM, van Gool A, Sijm W *et al.* (2010) Epidemiology of *Bonamia ostreae* infecting European flat oysters *Ostrea edulis* from Lake Grevelingen, The Netherlands. *Marine Ecology Progress Series* **409**: 131–142.
- Engelsma MY, Roozenburg I, Joly JP (2008) First isolation of *Nocardia crassostreae* from Pacific oyster *Crassostrea gigas* in Europe. *Diseases of Aquatic Organisms* **80**: 229–234.
- Erdmann W (1935) Untersuchungen über die Lebensgeschichte der Auster. Nr. 5. Über die Entwicklung und die Anatomie der ansatzreifen Larve von *Ostrea edulis* mit Bemerkungen über die Lebensgeschichte der Auster [Studies on the life history of the oyster. On the development and Anatomy of the approach-mature larva of *Ostrea edulis* with comments about the life history of the oyster]. *Wissenschaftliche Meeresuntersuchungen. Abt. Helgoland* **XIX**: 1–33.
- EU-Commission (2018) Enhancing native oyster stocks in Tralee Bay. FARNET Good Practice Project, pp. 1–3. Fisheries Areas Network, Ireland.
- Eyton TC (1858) *A History of the Oyster and the Oyster Fisheries*. J. Van Voorst, London.
- Fankboner PV, De Burgh ME (1978) Comparative rates of dissolved organic carbon accumulation by juveniles and pediveligers of the Japanese oyster *Crassostrea gigas* Thunberg. *Aquaculture* **13**: 205–212.
- FAO (2020) Fishery and aquaculture statistics, global production by production source 1950–2018 (Fishstat). *FAO Fisheries Division Online, Updated 2020*. Food and Agriculture Organization of the United Nations, Rome, Italy.
- Fernando W, MacBride EW (1931) The origin and development of the pericardium and kidneys in *Ostrea*. *Proceedings of the Royal Society of London. Series B, Containing Papers of a Biological Character* **107**: 391–397.
- Flannery G, Lynch SA, Carlsson J, Cross TF, Culloty SC (2014) Assessment of the impact of a pathogen, *Bonamia ostreae*, on *Ostrea edulis* oyster stocks with different histories of exposure to the parasite in Ireland. *Aquaculture* **432**: 243–251.
- Flannery G, Lynch SA, Culloty SC (2016) Investigating the significance of the role of *Ostrea edulis* larvae in the transmission and transfer of *Bonamia ostreae*. *Journal of Invertebrate Pathology* **136**: 7–9.

- Fox AD, Petersen Æ, Frederiksen M (2003) Annual survival and site-fidelity of breeding female Common Scoter *Melanitta nigra* at Mývatn, Iceland, 1925–58. *Ibis* **145**: E94–E96.
- Friedman CS, Perkins FO (1994) Range extension of *Bonamia ostreae* to Maine, U.S.A. *Journal of Invertebrate Pathology* **64**: 179–181.
- Friele H (1899) The oyster ponds on the west coast of Norway. In: Brunchorst J (ed.) *Proceedings of the International Congress of Fisheries Bergen*, pp. 188–200. John Griegs Boktrykkeri AS, Bergen.
- Funes VG, Jiménez RA (1989) Histological identification of the gonadal phases of the European oyster (*Ostrea edulis*), introduced experimentally into the Northwestern Coast of Baja California, Mexico. *Ciencias Marinas* **15**: 41–54.
- Gaarder T, Bjerkan P (1934) *Østers og Østerskultur i Norge*. A.s John Griegs Boktrykkeri, Bergen.
- Gaffney PM (2006) The role of genetics in shellfish restoration. *Aquatic Living Resources* **19**: 277–282.
- Gagné N, Cochennec N, Stephenson M, McGladdery S, Meyer GR, Bower SM (2008) First report of a Mikrocycytos-like parasite in European oysters *Ostrea edulis* from Canada after transport and quarantine in France. *Diseases of Aquatic Organisms* **80**: 27–35.
- Gann GD, McDonald T, Walder B, Aronson J, Nelson CR, Jonson J *et al.* (2019) International principles and standards for the practice of ecological restoration. Second edition. *Restoration Ecology* **27**: S1–S46.
- García-Lavandeira M, Silva A, Abad M, Pazos AJ, Sánchez JL, Pérez-Parallé ML (2005) Effects of GABA and epinephrine on the settlement and metamorphosis of the larvae of four species of bivalve molluscs. *Journal of Experimental Marine Biology and Ecology* **316**: 149–156.
- García-Meunier P, Martel C, Pigeot J, Chevalier G, Blanchard G, Gouletquer P *et al.* (2002) Recent invasion of the Japanese oyster drill along the French Atlantic coast: identification of specific molecular markers that differentiate Japanese, *Ocenebrellus inornatus*, and European, *Ocenebra erinacea*, oyster drills. *Aquatic Living Resources* **15**: 67–71.
- Gendreau S (1988) Fécondation in vitro et induction de la polyploidie chez l'huitre plate larvipare, *Ostrea edulis* L. [In vitro fertilization and induction of polyploidy in larviparous flat oyster *Ostrea edulis* L.], Publisher, PhD/DEA Thesis. University of Western Brittany, France.
- Gendreau S, Grizel H (1990) Induced triploidy and tetraploidy in the European flat oyster, *Ostrea edulis* L. *Aquaculture* **90**: 229–238.
- Gérard A, Naciri-Graven Y, Boudry P, Launay S, Heurtebise S, Ledu C *et al.* (1997) Contrôle de la gamétogenèse des huîtres creuses et plates: relations "reproduction" et "génétique" [Gametogenesis control of hollow and flat oysters: reproductive and genetic relationships]. In: Devauchelle N, Barret J, Salaun G (eds) *The Natural and Controlled Reproduction of Cultivated Bivalves in France: Symposium Report*, pp. 99–111. IFREMER, Nantes.
- Glamuzina B, Pešić A, Joksimović A, Glamuzina L, Matic-Skoko S, Conides A *et al.* (2014) Observations on the increase of wild gilthead seabream, *Sparus aurata* abundance, in the eastern Adriatic Sea: problems and opportunities. *International Aquatic Research* **6**: 127–134.
- Gofas S (2004) *WoRMS Taxon Details (Ostrea edulis Linnaeus, 1758)*. [Cited 01 Nov 2018.] Available from URL: [www.marinespecies.org](http://www.marinespecies.org).
- González-Araya R (2012) Incidence de la nutrition sur la reproduction et le développement larvaire d'*Ostrea edulis* [Impact of nutrition on reproduction and larval development of *Ostrea edulis*], Publisher, PhD/Dr Thesis. University of Brest, France.
- González-Araya R, Lebrun L, Quéré C, Robert R (2012a) The selection of an ideal diet for *Ostrea edulis* (L.) broodstock conditioning (Part B). *Aquaculture* **362**: 55–66.
- González-Araya R, Mingant C, Petton B, Robert R (2012b) Influence of diet assemblage on *Ostrea edulis* broodstock conditioning and subsequent larval development. *Aquaculture* **364**: 272–280.
- González-Araya R, Quéau I, Quéré C, Moal J, Robert R (2011) A physiological and biochemical approach to selecting the ideal diet for *Ostrea edulis* (L.) broodstock conditioning (Part A). *Aquaculture Research* **42**: 710–726.
- González-Araya R, Quillien V, Robert R (2013) The effects of eight single microalgal diets on sex-ratio and gonad development throughout European flat oyster (*Ostrea edulis* L.) conditioning. *Aquaculture* **400**: 1–5.
- González-Araya R, Robert R (2018) Larval development and fatty acid composition of *Ostrea edulis* (L.) fed four different single diets from conditioning to pre-settlement. *Aquaculture Research* **49**: 1–14.
- González-Wangüemert M, Pérez-Ruzafa A, Rosique MJ, Ortiz A (2004) Genetic differentiation in two cryptic species of *Ostreidae*, *Ostrea edulis* (Linnaeus, 1758) and *Ostreola stentina* (Payraudeau, 1826) in Mar Menor Lagoon, southwestern Mediterranean Sea. *The Nautilus* **118**: 103–111.
- Goulden EF, Høj L, Hall MR (2013) Microbial management for bacterial pathogen control in invertebrate aquaculture hatcheries. In: Allan G, Burnell G (eds) *Advances in Aquaculture Hatchery Technology*, pp. 246–285. Woodhead Publishing Limited, Cambridge.
- Gouletquer P, Héral M (1997) Marine molluscan production trends in France: from fisheries to aquaculture. In: MacKenzie CL, Burrell VG, Rosenfield A, Hobart WL (eds) *The History, Present Condition, and Future of the Molluscan Fisheries of North and Central America and Europe*, pp. 137–164. Scientific Publications Office, NMFS, NOAA, Seattle, WA.
- Gray MW, Chaparro O, Huebert KB, O'Neill SP, Couture T, Moreira A *et al.* (2019) Life history traits conferring larval resistance against ocean acidification: the case of brooding oysters of the genus *Ostrea*. *Journal of Shellfish Research* **38**: 751–761.



- Green DS (2016) Effects of microplastics on European flat oysters, *Ostrea edulis* and their associated benthic communities. *Environmental Pollution* **216**: 95–103.
- Grizel H (1985) Etude des récentes épizooties de l'huitre plate *Ostrea edulis* Linne et de leur impact sur l'ostréiculture bretonne [Study of recent epizootics of the flat oyster *Ostrea edulis* Linne and their impact on oyster farming in Brittany], Publisher, PhD/Dr Thesis. University of Montpellier, France.
- Grizel H, Comps M, Raguene D, Le Borgne Y, Tigé G, Martin AG (1983) Bilan des essais d'acclimatation d'*Ostrea chilensis* sur les côtes de Bretagne [Results of the acclimatization experiments of *Ostrea chilensis* on the Brittany Coasts]. *Revue des Travaux de l'Institut des Pêches Maritimes* **46**: 209–225.
- Grizel H, Héral M (1991) Introduction into France of the Japanese oyster (*Crassostrea gigas*). *ICES Journal of Marine Science* **47**: 399–403.
- Guesdon K, Le Bec C, Mazurie J, Lassale E (1989) Essais de télécapage: huitre plate [Remote setting trials: flat oyster]. Anonymous, In: *Section Régionale de Bretagne Sud : Plan de Relance de l'Huitre Plate 1989*, pp. 1–87. CIC-IFREMER, Auray.
- Guo X, DeBrosse GA, Allen SK (1996) All-triploid Pacific oysters (*Crassostrea gigas* Thunberg) produced by mating tetraploids and diploids. *Aquaculture* **142**: 149–161.
- Gutierrez AP, Turner F, Gharbi K, Talbot R, Lowe NR, Peñaloza C et al. (2017) Development of a medium density combined-species SNP array for Pacific and European oysters (*Crassostrea gigas* and *Ostrea edulis*). *G3: Genes, Genomes, Genetics* **7**: 2209–2218.
- Hadfield MG, Carpizo-Ituarte EJ, del Carmen K, Nedved BT (2001) Metamorphic competence, a major adaptive convergence in marine invertebrate larvae. *American Zoologist* **41**: 1123–1131.
- Haelters J, Kerckhof F (2009) Background document for *Ostrea edulis* and *Ostrea edulis* beds. In: *OSPAR Commission – Biodiversity Series*, pp. 1–22. Anonymous, London.
- Haenen OLM, Engelsma MY (2020) Jaarverslag schelpdierziekten 2019. *WBVR Report 2010660*, The Netherlands.
- Hancock DA (1954) The destruction of oyster spat by *Urosalpinx cinerea* (Say) on Essex oyster beds. *ICES Journal of Marine Science* **20**: 186–196.
- Hassan MM, Qin JG, Li XX (2017) Gametogenesis, sex ratio and energy metabolism in *Ostrea angasi*: implications for the reproductive strategy of spermcasting marine bivalves. *Journal of Molluscan Studies* **84**: 1–8.
- Hawkins AJS, Day AJ, Gerard A, Naciri Y, Ledu C, Bayne BL et al. (1994) A genetic and metabolic basis for faster growth among triploids induced by blocking meiosis I but not meiosis II in the larviparous European flat oyster, *Ostrea edulis* L. *Journal of Experimental Marine Biology and Ecology* **184**: 21–40.
- Hedgecock D (2011) Genetics of shellfish on a human-dominated planet. In: Shumway SE (ed) *Shellfish Aquaculture and the Environment*, pp. 339–357. John Wiley & Sons Inc, Oxford.
- Hedgecock D, Launey S, Pudovkin AI, Naciri Y, Lapegue S, Bonhomme F (2007) Small effective number of parents (Nb) inferred for a naturally spawned cohort of juvenile European flat oysters *Ostrea edulis*. *Marine Biology* **150**: 1173–1182.
- Helm MM, Bourne N, Lovatelli A (2004) Hatchery culture of bivalves: a practical manual. (ed.) *FAO Fisheries Technical Paper 471*, pp. 1–203. Food and Agriculture Organization of the United Nations, Rome, Italy.
- Helm MM, Spencer BE (1972) The importance of the rate of aeration in hatchery cultures of the larvae of *Ostrea edulis* L. *ICES Journal of Marine Science* **34**: 244–255.
- Helmer L, Hauton C, Bean T, Bass D, Hendy I, Harris-Scott E et al. (2020) Ephemeral detection of *Bonamia exitiosa* (Haplosporida) in adult and larval European flat oysters *Ostrea edulis* in the Solent, United Kingdom. *Journal of Invertebrate Pathology* **174**: 107421.
- Hepper BT (1956) The European flat oyster, *Ostrea edulis* L., as a host for *Mytilicola intestinalis* Steuer. *Journal of Animal Ecology* **25**: 144–147.
- Héral M (1990) Traditional oyster culture in France. In: Barnabé G, de IB Solbe JF (eds) *Aquaculture*, pp. 342–387. Ellis Horwood, Chichester.
- Herman A (1937) La reproduction des huîtres indigènes dans le Morbihan et le Finistère en 1936 [Reproduction of indigenous oysters in Morbihan and Finistère in 1936]. *Revue des Travaux de l'Institut des Pêches Maritimes* **10**: 61–66.
- Hidu H, Chapman S, Soule PW (1975) Cultchless setting of European oysters, *Ostrea edulis*, using polished marble. *Proceedings of the National Shellfisheries Association* **65**: 13–14.
- Hine PM, Engelsma MY, Wakefield SJ (2007) Ultrastructure of sporulation in *Haplosporidium armoricum*. *Diseases of Aquatic Organisms* **77**: 225–233.
- His E, Beiras R, Seaman MNL (1999) The assessment of marine pollution – bioassays with bivalve embryos and larvae. In: Southward AJ, Tyler PA, Young CM (eds) *Advances in Marine Biology*, pp. 1–178. Academic Press, London.
- Hoeksema BW (1983) Excavation patterns and spiculae dimensions of the boring sponge *Cliona celata* from the SW Netherlands. *Senckenbergiana Maritima* **15**: 55–85.
- Holland DL, Spencer BE (1973) Biochemical changes in fed and starved oysters, *Ostrea edulis* L. during larval development, metamorphosis and early spat growth. *Journal of the Marine Biological Association of the United Kingdom* **53**: 287–298.
- Holmes JMC, Minchin D (1991) A new species of Herrmannella (Copepoda, Poecilostomatoida, Sabelliphilidae) associated with the oyster *Ostrea edulis* L. *Crustaceana* **60**: 258–269.
- Horst R (1884). The development of the oyster (*Ostrea edulis* L.). *Report of the Commissioner for 1884* **12**: 891–911.
- Horváth Á, Bubalo A, Čučević A, Bartulović V, Kotrik L, Urbányi B et al. (2012) Cryopreservation of sperm and larvae of the European flat oyster (*Ostrea edulis*). *Journal of Applied Ichthyology* **28**: 948–951.
- Hugh Jones D (1999) Breeding ponds as a basis for flat oyster (*Ostrea edulis*) culture and their use to develop resistance to

- the disease *Bonamia ostreae*. *Journal of Shellfish Research* **18**: 718.
- Hughes AR, Inouye BD, Johnson MTJ, Underwood N, Vellend M (2008) Ecological consequences of genetic diversity. *Ecology Letters* **11**: 609–623.
- Hughes E (1940) The breeding of oysters in tanks. *Journal of the Marine Biological Association of the United Kingdom* **24**: 543–547.
- Hurwood DA, Heasman MP, Mather PB (2005) Gene flow, colonisation and demographic history of the flat oyster *Ostrea angasi*. *Marine and Freshwater Research* **56**: 1099–1106.
- Ivanov AI (1964) Размножение, рост и распределение черноморских устриц [Breeding, growth and distribution of Black Sea oysters]. Anonymous, In: *Sbornik Nauchno-Tekhnicheskoy Informatsii VNIRO* 3, pp. 3–13. Russian Research Institute of Fisheries and Oceanography, Moscow.
- Jeffries VE (1982) Three vibrio strains pathogenic to larvae of *Crassostrea gigas* and *Ostrea edulis*. *Aquaculture* **29**: 201–226.
- Jones JB (2006) Why won't they grow? – Inhibitory substances and mollusc hatcheries. *Aquaculture International* **14**: 395–403.
- Joyce A, Holthuis TD, Charrier G, Lindegarth S (2013) Experimental effects of temperature and photoperiod on synchrony of gametogenesis and sex ratio in the European oyster *Ostrea edulis* (Linnaeus). *Journal of Shellfish Research* **32**: 447–458.
- Jozefowicz CJ, Foighil DÓ (1998) Phylogenetic analysis of southern hemisphere flat oysters based on partial mitochondrial 16S rDNA gene sequences. *Molecular Phylogenetics and Evolution* **10**: 426–435.
- Kamphausen L, Jensen A, Hawkins L (2011) Unusually high proportion of males in a collapsing population of commercially fished oysters (*Ostrea edulis*) in the Solent, United Kingdom. *Journal of Shellfish Research* **30**: 217–222.
- Kang DH, Kim SJ, Choi KS (2004) Microscopic observations of larval *Ostrea circumpicta* (Bivalve: Ostreidae) in brood chambers. *Journal of Shellfish Research* **23**: 411–415.
- Kerckhof F, Coolen JWP, Rumes B, Degraer S (2018) Recent findings of wild European flat oysters *Ostrea edulis* (Linnaeus, 1758) in Belgian and Dutch offshore waters: new perspectives for offshore oyster reef restoration in the southern North Sea. *Belgian Journal of Zoology* **148**: 13–24.
- Kesarcodi-Watson A, Miner P, Nicolas JL, Robert R (2012) Protective effect of four potential probiotics against pathogen-challenge of the larvae of three bivalves: Pacific oyster (*Crassostrea gigas*), flat oyster (*Ostrea edulis*) and scallop (*Pecten maximus*). *Aquaculture* **344–349**: 29–34.
- Khouw BT (1965) Some studies on the biology of a species of *Hexamita* derived from the oyster, *Crassostrea virginica* (Gmelin), Publisher, MSc Thesis. University of Windsor, Canada.
- Kirkland DW, Bradbury JP, Dean WE (1980) The heliothermic lake: a direct method of collecting and storing solar energy. *Open-File Report 80–807*, pp. 1–133. US Geological Survey, USA.
- Klaveness D (1990) Size structure and potential food value of the plankton community to *Ostrea edulis* L. in a traditional Norwegian “Østerspoll”. *Aquaculture* **86**: 231–247.
- Klaveness D. (1992) Augmentation of the food supply for oyster larvae via bacterivorous flagellates: possible implications for larval breeding and oyster pond management. *Aquaculture Research* **23**: 591–597.
- Klaveness D, Johansen SW (1990) The oyster ponds at the Norwegian coast: remarkable biotopes for marine algae. *Blyttia* **48**: 27–31.
- Knauer J, Southgate PC (1999) A Review of the nutritional requirements of bivalves and the development of alternative and artificial diets for bivalve aquaculture. *Reviews in Fisheries Science* **7**: 241–280.
- Korringa P (1940) Experiments and observations on swarming, pelagic life and setting in the European flat oyster, *Ostrea edulis* L., Publisher, PhD/Dr Thesis. University of Amsterdam, The Netherlands.
- Korringa P (1946) A revival of natural oyster beds? *Nature* **158**: 586–587.
- Korringa P (1951a) *Crepidula fornicata* as an oyster-pest. *ICES Marine Science Symposia. Volume 128*, pp. 55–59. International Council for the Exploration of the Sea, Copenhagen, Denmark.
- Korringa P (1951b) Difficulties encountered in tank-breeding of oysters (*Ostrea edulis*). *ICES Marine Science Symposia. Volume 128-2*, pp. 35–38. International Council for the Exploration of the Sea, Copenhagen, Denmark.
- Korringa P. (1976) *Farming the Flat Oysters of the Genus Ostrea. Developments in Aquaculture and Fisheries Science*. Elsevier Scientific Publishing Company, Amsterdam.
- Kristensen PS (1997) Oyster and mussel fisheries in Denmark. In: MacKenzie CL, Burrell VG, Rosenfield A, Hobart WL (eds) *The History, Present Condition, and Future of the Molluscan Fisheries of North and Central America and Europe*, pp. 25–38. Scientific Publications Office, NMFS, NOAA, Seattle, WA.
- KVB, Anonymous (2017) Denne 100 mål store pøylø har ideelle forhold for dyrking av flatøsters. [Cited 01 Aug 2017.] Available from URL: <https://www.midtsiden.no/over-100-ar-med-flatosters-fra-os>.
- Labarta U, Fernández-Reiriz MJ, Pérez-Camacho A (1999) Larvae of *Ostrea edulis* (L.) during starvation: growth, energy and biochemical substrates. *Hydrobiologia* **405**: 125–131.
- Laing I, Walker P, Areal F (2006) Return of the native – is European oyster (*Ostrea edulis*) stock restoration in the UK feasible? *Aquatic Living Resources* **19**: 283–287.
- Lallias D, Boudry P, Lapègue S, King JW, Beaumont AR (2010) Strategies for the retention of high genetic variability in European flat oyster (*Ostrea edulis*) restoration programmes. *Conservation Genetics* **11**: 1899–1910.
- Lallias D, Gomez-Raya L, Haley CS, Arzul I, Heurtebise S, Beaumont AR *et al.* (2009) Combining two-stage testing and interval mapping strategies to detect QTL for resistance to Bonamiosis in the European flat oyster *Ostrea edulis*. *Marine Biotechnology* **11**: 570.
- Lama A, Montes J (1993) Influence of depth of culture in the infection of the European flat oyster (*Ostrea edulis* L.) by

- Bonamia ostreae*. *Bulletin of the European Association of Fish Pathologists* **13**: 17–20.
- Lane A (1989) The effect of a microencapsulated fatty acid diet on larval production in the European flat oyster *Ostrea edulis* L. In: De Pauw N, Jaspers E, Ackefors H, Wilkins N (eds) *Aquaculture: A Biotechnology in Progress: Proceedings of the International Conference Aquaculture Europe*, pp. 657–664. European Aquaculture Society, Bredene.
- Lane HS, Webb SC, Duncan J (2016) *Bonamia ostreae* in the New Zealand oyster *Ostrea chilensis*: a new host and geographic record for this haplosporidian parasite. *Diseases of Aquatic Organisms* **118**: 55–63.
- Lapègue S, Beaumont A, Boudry P, Gouletquer P (2007) Genetic effects of domestication, culture and breeding of fish and shellfish, and their impacts on wild populations. European flat oyster – *Ostrea edulis*. In: Svåsand T, Crosetti D, García-Vázquez E, Verspoor E (eds) *Genetic impact of aquaculture activities on native populations. Gen-impact final scientific report (EU contract n. RICA-CT2005-022802)*, pp. 70–75. EU, Online.
- Lauckner G (1983) Diseases of mollusca: bivalvia. In: Kinne O (ed.) *Diseases of Marine Animals*, pp. 477–961. Biologische Anstalt Helgoland, Hamburg.
- Launey S, Ledu C, Boudry P, Bonhomme F, Naciri-Graven Y (2002) Geographic structure in the European Flat Oyster (*Ostrea edulis* L.) as revealed by microsatellite polymorphism. *Journal of Heredity* **93**: 331–351.
- Li MF, Drinnan RE, Drebot M, Newkirk G (1983) Studies of shell disease of the European flat oyster *Ostrea edulis* Linne in Nova Scotia. *Journal of Shellfish Research* **3**: 135–140.
- Locard A (1900) *Manuel Pratique d'Ostréiculture*. JB Baillière & Fils, Paris.
- Lodeiros C, Bolinches J, Dopazo CP, Toranzo AE (1987) Bacterial necrosis in hatcheries of *Ostrea edulis* in Spain. *Aquaculture* **65**: 15–29.
- Loosanoff VL, Davis HC (1963) Rearing of bivalve mollusks. In: Russell FS (ed.) *Advances in Marine Biology*, pp. 1–136. Academic Press Inc, London.
- López-Sanmartín M, Batista FM, del Carmen MM, Garrido I, Quintero D, Grade A et al. (2015) Detection of *Marteilia refringens* infecting the European flat oyster *Ostrea edulis* and the dwarf oyster *Ostrea stentina* in southern Portugal and Spain. *Journal of Invertebrate Pathology* **130**: 52–55.
- Lubet P. (1991) Reproduction des mollusques [Reproduction of molluscs]. In: Barnabé G (ed.) *Bases Biologiques et Écologiques de l'Aquaculture*, pp. 168–204. Tec & Doc, Lavoisier, Paris.
- Lynch SA, Armitage DV, Wyld S, Mulcahy MF, Culloty SC (2005) The susceptibility of young prespawning oysters, *Ostrea edulis*, to *Bonamia ostreae*. *Journal of Shellfish Research* **24**: 1019–1025.
- Lynch SA, Flannery G, Hugh-Jones T, Hugh-Jones D, Culloty SC (2014) Thirty-year history of Irish (Rossmore) *Ostrea edulis* selectively bred for disease resistance to *Bonamia ostreae*. *Diseases of Aquatic Organisms* **110**: 113–121.
- Mackin JG, Korringa P, Hopkins SH (1951) Hexamitiasis of *Ostrea edulis* L. and *Crassostrea virginica* (Gmelin). *Bulletin of Marine Science* **1**: 266–277.
- Maneiro V, Pérez-Parallé ML, Pazos AJ, Silva A, Sánchez JL (2016) Combined effects of temperature and photoperiod on the conditioning of the flat oyster (*Ostrea edulis* [Linnaeus, 1758]) in winter. *Journal of Shellfish Research* **35**: 137–141.
- Maneiro V, Pérez-Parallé ML, Silva A, Sánchez JL, Pazos AJ (2017a) Conditioning of the European flat oyster (*Ostrea edulis*, Linnaeus 1758): effect of food ration. *Aquaculture Research* **48**: 4363–4370.
- Maneiro V, Santos Y, Pazos AJ, Silva A, Torres-Corral Y, Sánchez JL et al. (2020) Effects of food ration, water flow rate and bacteriological levels of broodstock on the reproductive conditioning of the European flat oyster (*Ostrea edulis*, Linnaeus 1758). *Aquaculture Reports* **18**: 100412.
- Maneiro V, Silva A, Pazos AJ, Sánchez JL, Pérez-Parallé ML (2017b) Effects of temperature and photoperiod on the conditioning of the flat oyster (*Ostrea edulis* L.) in autumn. *Aquaculture Research* **48**: 4554–4562.
- Mann R (1979) Some biochemical and physiological aspects of growth and gametogenesis in *Crassostrea gigas* and *Ostrea edulis* grown at sustained elevated temperatures. *Journal of the Marine Biological Association of the United Kingdom* **59**: 95–110.
- Mann R (1984) Bivalve mollusc hatcheries: a critical appraisal of their development and a review of their potential value in enhancing the fisheries of developing nations. In: Winter JE, Clasing E, Gutierrez A (eds) *Memorias de la Asociación Latinoamericana de Acuicultura*, pp. 97–105. Universidad Austral de Chile, Valdivia.
- Mardones-Toledo DA, Montory JA, Joyce A, Thompson RJ, Diederich CM, Pechenik JA et al. (2015) Brooding in the Chilean oyster *Ostrea chilensis*: unexpected complexity in the movements of brooded offspring within the mantle cavity. *PLoS One* **10**: 1–18.
- Marshall R, McKinley S, Pearce CM (2010) Effects of nutrition on larval growth and survival in bivalves. *Reviews in Aquaculture* **2**: 33–55.
- Marteil L (1959) Les bancs naturels et la reproduction de l'huître plate en Morbihan [Natural banks and reproduction of flat oyster in Morbihan]. *Revue des Travaux de l'Institut des Pêches Maritimes* **23**: 287–295.
- Marteil L (1976) La conchyliculture française. Partie 2: biologie de l'huître et de la moule [Shellfish culture in France. Part 2: oyster and mussel biology]. *Revue des Travaux de l'Institut des Pêches Maritimes* **40**: 149–346.
- Martin AG, Littaye-Mariette A, Langlade A, Allenou JP (1997) Cycle de reproduction naturelle de l'huître plate *Ostrea edulis* [Natural reproductive cycle of the flat oyster *Ostrea edulis*]. In: Devauchelle N, Barret J, Salaun G (eds) *The Natural and Controlled Reproduction of Cultivated Bivalves in France: Symposium Report*, pp. 21–33. IFREMER, Nantes.

- Mascaró M, Seed R (2001a) Choice of prey size and species in *Carcinus maenas* (L.) feeding on four bivalves of contrasting shell morphology. *Hydrobiologia* **449**: 159–170.
- Mascaró M, Seed R (2001b) Foraging behavior of juvenile *Carcinus maenas* (L.) and *Cancer pagurus* L. *Marine Biology* **139**: 1135–1145.
- Matthews JBL, Heimdal BR (1980) Pelagic productivity and food chains in fjord systems. In: Freeland HJ, Farmer DM, Levings CD (eds) *Fjord Oceanography*, pp. 377–398. Plenum Press, New-York.
- McGonigle C, O'Donnell R, Aine T, Tom Sheerin T (2020) Native oyster spawning assessment. Anonymous, In: *Lough Foyle Summer 2019*, pp. 1–46. Loughs Agency, Scotland.
- Merk V, Colsoul B, Pogoda B (2020) Return of the native: survival, growth and condition of European oysters reintroduced to German offshore waters. *Aquatic Conservation: Marine and Freshwater Ecosystems* **30**: 2180–2190.
- Mesías-Gansbiller C, Silva A, Maneiro V, Pazos A, Sánchez JL, Pérez-Parallé ML (2013) Effects of chemical cues on larval settlement of the flat oyster (*Ostrea edulis* L.): a hatchery approach. *Aquaculture* **376**: 85–89.
- Millar RH, Scott JM (1967) The larva of the oyster *Ostrea edulis* during starvation. *Journal of the Marine Biological Association of the United Kingdom* **47**: 475–484.
- Millican PF, Helm MM (1994) Effects of nutrition on larvae production in the European flat oyster, *Ostrea edulis*. *Aquaculture* **123**: 83–94.
- Mizuta DD, Wikfors GH (2018) Seeking the perfect oyster shell: a brief review of current knowledge. *Reviews in Aquaculture* **11**: 1–17.
- Möbius K (1883) The oyster and oyster culture. *Report of the Commissioner for 1880* **8**: 683–751.
- Mortensen SH (1992) The health status of commercially exploited native flat oysters (*Ostrea edulis*) in Norway. Anonymous, In: *ICES CM Document K:44*, pp. 1–10. International Council for the Exploration of the Sea, Copenhagen.
- Mortensen S, Sælemyr L, Skår CK, Jelmert A (2018) The surveillance and control programme for bonamiosis and marteiliosis in European flat oysters, *Ostrea edulis*, and blue mussels, *Mytilus* sp. in Norway in 2017. *IMR Project Report Nr. 17-2018*, pp. 1–12. Institute of Marine Research, Bergen, Norway.
- Morton B, Lam K, Slack-Smith S (2003) First report of the European flat oyster *Ostrea edulis*, identified genetically, from Oyster Harbour, Albany, South-Western Australia. *Molluscan Research* **23**: 199–208.
- Muller-Feuga A. (1997) Microalgues marines, les enjeux de la recherche [Marine microalgae, the research stakes]. Anonymous, In: *Ifremer: Bilans et Prospectives*, pp. 1–37. French Research Institute for Exploitation of the Sea, Plouzané.
- Naas KE (1991) A semi-intensive method for spat production of the European flat oyster (*Ostrea edulis* L.). *Aquacultural Engineering* **9**: 447–451.
- Naas KE, Berg L, Øiestad V (1986) Effect of turbulence and different types of fertilizers on phytoplankton and oyster larvae (*Ostrea edulis*) in mesocosms. Anonymous, In: *ICES CM Document K:41*, pp. 1–12. International Council for the Exploration of the Sea, Copenhagen.
- Naciri-Graven Y, Martin AG, Baud JP, Renault T, Gerard A (1998) Selecting the flat oyster *Ostrea edulis* (L.) for survival when infected with the parasite *Bonamia ostreae*. *Journal of experimental marine Biology and Ecology* **224**: 91–107.
- Nell JA (2002) Farming triploid oysters. *Aquaculture* **210**: 69–88.
- Nelson TC, Allison JB (1940) On the nature and action of diantlin; a new hormone-like substance carried by the spermatozoa of the oyster. *Journal of Experimental Zoology* **85**: 299–338.
- Newkirk GF (1980) Review of the genetics and the potential for selective breeding of commercially important bivalves. *Aquaculture* **19**: 209–228.
- Newkirk GF (1986) Controlled mating of the European oyster, *Ostrea edulis*. *Aquaculture* **57**: 111–116.
- Newkirk GF, Haley LE (1982) Progress in selection for growth rate in the European oyster *Ostrea edulis*. *Marine Ecology Progress Series* **10**: 77–79.
- Nielsen M, Hansen BW, Vismann B (2016) Feeding traits of the European flat oyster, *Ostrea edulis*, and the invasive Pacific oyster, *Crassostrea gigas*. *Marine Biology* **164**: 6.
- Nielsen P, Petersen JK (2019) Flat oyster fishery management during a time with fluctuating population size. *Aquatic Living Resources* **32**: 22.
- Orton JH (1927) Observation and experiments on sex-change in the European Oyster (*O. edulis*): Part I. The change from female to male. *Journal of the Marine Biological Association of the United Kingdom* **14**: 967–1045.
- Orton JH (1936) Observation and experiments on sex-change in the European Oyster (*O. edulis*): Part V. A simultaneous study of spawning in 1927 in two distinct geographical localities. Anonymous, In: *Mémoires du Musée Royal d'Histoire Naturelle de Belgique*. Musée Royal d'Histoire Naturelle de Belgique, pp. 997–1056. Bruxelles.
- Orton JH (1937) *Oyster Biology and Oyster Culture: Being the Buckland Lectures for 1935*. Edward Arnold & Company, London.
- Partensky F, Vault D (1989) Cell size differentiation in the bloom-forming dinoflagellate *Gymnodinium* CF. nagasakiense. *Journal of Phycology* **25**: 741–750.
- Pascual M, Martin AG, Zampatti E, Coatanea D, Defosse J, Robert R (1991) Testing of the Argentina oyster, *Ostrea puelchana*, in several French oyster farming sites. Anonymous, In: *ICES CM Document K:30*, pp. 1–17. International Council for the Exploration of the Sea, Copenhagen.
- Peraš I, Gvozdenović S, Petović S, Mandić M (2018) Comparative analysis of bivalves diversity on experimental spat collectors. *Water Research and Management* **8**: 25–31.
- Philpots JR (1890) *Oysters, and all about them*. J. Richardson, London.
- Pogoda B (2019) Current status of European oyster decline and restoration in Germany. *Humanities* **8**: 9.
- Pogoda B, Boudry P, Bromley C, Cameron TC, Colsoul B, Donnan D *et al.* (2020) NORA moving forward: developing an oyster restoration network in Europe to support the Berlin

- Oyster Recommendation. *Aquatic Conservation: Marine and Freshwater Ecosystems* **30**: 2031–2037.
- Pogoda B, Brown J, Hancock B, Preston J, Pouvreau S, Kamermans P et al. (2019) The Native Oyster Restoration Alliance (NORA) and the Berlin Oyster Recommendation: bringing back a key ecosystem engineer by developing and supporting best practice in Europe. *Aquatic Living Resources* **32**: 13.
- Prado P, Roque A, Pérez J, Ibáñez C, Alcaraz C, Casals F et al. (2016) Warming and acidification-mediated resilience to bacterial infection determine mortality of early *Ostrea edulis* life stages. *Marine Ecology Progress Series* **545**: 189–202.
- Prado S, Montes J, Romalde JL, Barja JL (2009) Inhibitory activity of *Phaeobacter* strains against aquaculture pathogenic bacteria. *International Microbiology* **12**: 107–114.
- Prado S, Romalde JL, Montes J, Barja JL (2005) Pathogenic bacteria isolated from disease outbreaks in shellfish hatcheries. First description of *Vibrio neptunius* as an oyster pathogen. *Diseases of Aquatic Organisms* **67**: 209–215.
- Prado S, Romalde JL, Barja JL (2010) Review of probiotics for use in bivalve hatcheries. *Veterinary Microbiology* **145**: 187–197.
- Prytherch HF (1924) Experiments in the artificial propagation of oysters. In: O'Malley H. (ed.) *Report of the United States Commissioner of Fisheries for the Fiscal Year 1923*, pp. 1–14. United States Commissioner of Fisheries, Washington, DC.
- Renault T, Arzul I (2001) Herpes-like virus infections in hatchery-reared bivalve larvae in Europe: specific viral DNA detection by PCR. *Journal of Fish Diseases* **24**: 161–167.
- Renault T, Le Deuff RM, Chollet B, Cochenne N, Gérard A (2000) Concomitant herpes-like virus infections in hatchery-reared larvae and nursery-cultured spat *Crassostrea gigas* and *Ostrea edulis*. *Diseases of Aquatic Organisms* **42**: 173–183.
- Renzoni A (1973) The influence of some detergents on the larval life of marine bivalve larvae. In: Genovese S (ed.) *Proceedings of the 5th International Colloquium of Medical Oceanography*, pp. 101–104. University of Messina, Messina.
- Rice MA, Wallis K, Stephens GC (1980) Influx and net flux of amino acids into larval and juvenile European flat oysters, *Ostrea edulis* (L.). *Journal of Experimental Marine Biology and Ecology* **48**: 51–59.
- Richardson CA, Collis SA, Ekaratne K, Dare P, Key D (1993) The age determination and growth rate of the European flat oyster, *Ostrea edulis*, in British waters determined from acetate peels of umbo growth lines. *ICES Journal of Marine Science* **50**: 493–500.
- Rikard FS, Walton WC (2012) Use of microalgae concentrates for rearing oyster larvae, *Crassostrea virginica*. Mississippi-Alabama Sea Grant Publication: MASGP-12-048.
- Robert R, Borel M, Pichot Y, Trut G (1991) Growth and mortality of the European oyster *Ostrea edulis* in the Bay of Arcachon (France). *Aquatic Living Resources* **4**: 265–274.
- Robert R, Gérard A (1999) Bivalve hatchery technology: the current situation for the Pacific oyster *Crassostrea gigas* and the scallop *Pecten maximus* in France. *Aquatic Living Resources* **12**: 121–130.
- Robert R, His E, Dinét A (1988) Combined effects of temperature and salinity on fed and starved larvae of the European flat oyster *Ostrea edulis*. *Marine Biology* **97**: 95–100.
- Robert R, Trintignac P (1997) Substitutes for live microalgae in mariculture: a review. *Aquatic Living Resources* **10**: 315–327.
- Robert R, Vignier J, Petton B (2017) Influence of feeding regime and temperature on development and settlement of oyster *Ostrea edulis* (Linnaeus, 1758) larvae. *Aquaculture Research* **48**: 1–18.
- Roché G (1898) *La Culture des Mers en Europe: Pisciculture – Pisciculture – Ostréiculture*. Félix Alcan, Editeur, Paris, France.
- Rodriguez-Perez A, James M, Donnan DW, Henry TB, Møller LF, Sanderson WG (2019) Conservation and restoration of a keystone species: understanding the settlement preferences of the European oyster (*Ostrea edulis*). *Marine Pollution Bulletin* **138**: 312–321.
- Rogan E, Cross TF (1996) Nutrient dynamics and plankton cycles in artificial ponds used in the production of oyster *Ostrea edulis* L. spat. *Aquaculture Research* **27**: 9–23.
- Rosell D, Uriz MJ, Martin D (1999) Infestation by excavating sponges on the oyster (*Ostrea edulis*) populations of the Blanes littoral zone (north-western Mediterranean Sea). *Journal of the Marine Biological Association of the United Kingdom* **79**: 409–413.
- Ruiz C, Martinez D, Mosquera G, Abad M, Sánchez JL (1992) Seasonal variations in condition, reproductive activity and biochemical composition of the flat oyster, *Ostrea edulis*, from San Cibrao (Galicia, Spain). *Marine Biology* **112**: 67–74.
- Saavedra C (1997) Low effective sizes in hatchery populations of the European oyster (*Ostrea edulis*): implications for the management of genetic resources. *Journal of Shellfish Research* **16**: 441–446.
- Saavedra C, Zapata C, Alvarez G (1995) Geographical patterns of variability at allozyme loci in the European oyster *Ostrea edulis*. *Marine Biology* **122**: 95–104.
- Sas H, Deden B, Kamermans P, zu Ermgassen P, Pogoda B, Preston J et al. (2020) Bonamia infection in flat oysters (*Ostrea edulis*) in relation to European restoration projects. *Aquatic Conservation: Marine and Freshwater Ecosystems* **30**: 2150–2162.
- Shpigel M (1989) Gametogenesis of the European flat oyster (*Ostrea edulis*) and Pacific oyster (*Crassostrea gigas*) in warm water in Israel. *Aquaculture* **80**: 343–349.
- da Silva PM, Fuentes J, Villalba A (2005) Growth, mortality and disease susceptibility of oyster *Ostrea edulis* families obtained from brood stocks of different geographical origins, through on-growing in the Ría de Arousa (Galicia, NW Spain). *Marine Biology* **147**: 965–977.
- da Silva P, Renault T, Fuentes J, Villalba A (2008) Herpesvirus infection in European flat oysters *Ostrea edulis* obtained from brood stocks of various geographic origins and grown in Galicia (NW Spain). *Diseases of Aquatic Organisms* **78**: 181–188.
- Skaramuca B, Teskeredžić E, Teskeredžić Z (1997) Mariculture in Croatia, history and perspectives. *Ribarstvo* **55**: 19–26.

- Smolowitz R, Shumway SE (1997) Possible cytotoxic effects of the dinoflagellate, *Gyrodinium aureolum*, on juvenile bivalve molluscs. *Aquaculture International* **5**: 291–300.
- Smyth D, Mahon AM, Roberts D, Kregting L (2018) Settlement of *Ostrea edulis* is determined by the availability of hard substrata rather than by its nature: implications for stock recovery and restoration of the European oyster. *Aquatic Conservation: Marine and Freshwater Ecosystems* **28**: 1–10.
- Sobolewska H, Beaumont AR (2005) Genetic variation at microsatellite loci in northern populations of the European flat oyster (*Ostrea edulis*). *Journal of the Marine Biological Association of the United Kingdom* **85**: 955–960.
- Spärck R (1925) Studies on the biology of oyster (*Ostrea edulis*) in the Limfjord, with special reference to the influence of temperature on the sex change. In: Petersen CGJ (ed.) *Report of the Danish Biological Station to the Board of Agriculture*, pp. 1–84. Danish Biological Station, Copenhagen.
- Spark E, Roberts S, Deveney M, Bradley T, Dang C, Wronski E et al. (2018) National biosecurity plan guidelines for Australian oyster hatcheries. Anonymous, In: *PIRSA Fisheries and Aquaculture 2018*, pp. 1–66. Australian Government Department of Agriculture and Water Resources, Canberra, ACT.
- Spencer B.E. (2008) *Molluscan Shellfish Farming*. Fishing News Books, Blackwell Publishing, Oxford.
- Stanley JG, Allen SK, Hidu H (1981) Polyploidy induced in the American oyster, *Crassostrea virginica*, with cytochalasin B. *Aquaculture* **23**: 1–10.
- Strand Å, Wrange AL, Hogström P, Nielsen JW, Persson P, Persson K (2018) Produktion av ostronyngel (*Ostrea edulis*) i havsbaserade tankar. Biologisk och teknisk förstudie [Production of oyster larvae (*Ostrea edulis*) in offshore tanks. Biological and technical feasibility study]. *IVL Report C 380*, pp. 1–70. IVL Svenska Miljöinstitutet, Stockholm, Sweden.
- Strand Ø, Vølstad JH (1997) The molluscan fisheries and culture of Norway. In: MacKenzie CL, Burrell VG, Rosenfield A, Hobart WL (eds) *The History, Present Condition, and Future of the Molluscan Fisheries of North and Central America and Europe*, pp. 7–24. Scientific Publications Office, NMFS, NOAA, Seattle, WA.
- Suquet M, González-Araya R, Lebrun L, Queau I, Mingant C, Robert R (2010) Anaesthesia and gonad sampling in the European flat oyster (*Ostrea edulis*). *Aquaculture* **308**: 196–198.
- Suquet M, Pouvreau S, Queau I, Boulais M, Le Grand J, Ratiskol D et al. (2018) Biological characteristics of sperm in European flat oyster (*Ostrea edulis*). *Aquatic Living Resources* **31**: 1–7.
- Syvret M, James J, Bayes J, Woolmer A (2017) Closing the circle report II: development of a generic shellfish hatchery design with associated spatting ponds. *Seafish Report No. SR705*, pp. 1–54. Mumbles Oyster Company Ltd., UK.
- Tallec K, Huvet A, Di Poi C, González-Fernández C, Lambert C, Petton B et al. (2018) Nanoplastics impaired oyster free living stages, gametes and embryos. *Environmental Pollution* **242**: 1226–1235.
- Tardiveau B (2020) Quiberon: les plates recouvrent les coupelles [Quiberon: flat oysters covers the collectors]. *Cultures Marines* **335**: 32.
- Thain JE, Waldo MJ (1986) The impact of tributyl tin (TBT) antifouling paints on molluscan fisheries. *Water Science and Technology* **18**: 193–202.
- Theede H, Ponat A, Hiroki K, Schlieper C (1969) Studies on the resistance of marine bottom invertebrates to oxygen-deficiency and hydrogen sulphide. *Marine Biology* **2**: 325–337.
- Tige G, Comps M, Grizel H (1977) Présence d'une coccidie parasite du rein chez *Ostrea edulis* L. [Presence of a Coccidia parasite of the kidney in *Ostrea edulis* L.]. *Revue des Travaux de l'Institut des Pêches Maritimes* **41**: 223–225.
- Todorova V, Micu D, Klisurov L (2009) Unique oyster reefs discovered in the Bulgarian Black Sea. *Proceedings of the Bulgarian Academy of Sciences* **62**: 871–874.
- Tomšić S, Lovrić J (2004) Historical overview of oyster culture in Mali Ston Bay. *Naše More* **51**: 17–23.
- Toro JE, Newkirk GF (1990) Divergent selection for growth rate in the European oyster *Ostrea edulis*: response to selection and estimation of genetic parameters. *Marine Ecology Progress Series* **62**: 219–227.
- Travers MA, Boettcher Miller K, Roque A, Friedman CS (2015) Bacterial diseases in marine bivalves. *Journal of Invertebrate Pathology* **131**: 11–31.
- Tritar S, Prieur D, Weiner R (1992) Effects of bacterial films on the settlement of oysters, *Crassostrea gigas* (Thunberg, 1793) and *Ostrea edulis* Linnaeus, 1750, and the scallop, *Pecten maximus* (Linnaeus, 1758). *Journal of Shellfish Research* **11**: 325–330.
- Tubiash HS, Chanley PE, Leifson E (1965) Bacillary necrosis, a disease of larval and juvenile bivalve mollusks. I. Etiology and epizootiology. *Journal of Bacteriology* **90**: 1036–1044.
- Ulvestad KB, Strand Ø (1997) Modelling hydrography and algal production in a poll in western Norway. *Ecological Modelling* **101**: 285–301.
- Utting SD, Helm MM, Millican PF (1991) Recent studies on the fecundity of European flat oyster (*Ostrea edulis*) spawning stock in the solent. *Journal of the Marine Biological Association of the United Kingdom* **71**: 909–911. <https://doi.org/10.1017/S002531540005356x>
- Utting SD, Spencer BE (1991) The hatchery culture of bivalve mollusc larvae and juveniles. Anonymous, In: *MAFF Laboratory Leaflet 68*, pp. 1–32. Ministry of Agriculture, Fisheries and Food, Directorate of Fisheries Research, Lowestoft.
- Vallauri DR, Aronson J, Barbero M (2002) An analysis of forest restoration 120 years after reforestation on Badlands in the Southwestern Alps. *Restoration Ecology* **10**: 16–26.
- Vera M, Pardo BG, Cao A, Vilas R, Fernández C, Blanco A et al. (2019) Signatures of selection for bonamiosis resistance in European flat oyster (*Ostrea edulis*): new genomic tools for breeding programs and management of natural resources. *Evolutionary Applications* **12**: 1781–1796.
- Vercaemer B, Spence KR, Herbinger CM, Lapègue S, Kenchington EL (2006) Genetic diversity of the European oyster

- (*Ostrea edulis* L.) in Nova Scotia: comparison with other parts of Canada, Maine and Europe and implications for brood-stock management. *Journal of Shellfish Research* **25**: 543–551.
- Virvilis C, Angelidis P (2006) Presence of the parasite *Marteilia* sp. in the flat oyster (*Ostrea edulis* L.) in Greece. *Aquaculture* **259**: 1–5.
- Vitiello V, Carlino PA, Del Prete F, Langellotti AL, Sansone G (2011) Effects of cooling and freezing on the motility of *Ostrea edulis* (L., 1758) spermatozoa after thawing. *Cryobiology* **63**: 118–124.
- Voultsiadou E, Koutsoubas D, Achparaki M (2010) Bivalve mollusc exploitation in Mediterranean coastal communities: an historical approach. *Journal of Biological Research-Thessaloniki* **13**: 35–45.
- Waller TR (1981) Functional morphology and development of veliger larvae of the European oyster, *Ostrea edulis* Linné. In: Waller TR (ed.) *Smithsonian Contribution to Zoology* 328, pp. 1–80. Smithsonian Institution Press, Washington, DC.
- Walne PR (1958) The importance of bacteria in laboratory experiments on rearing the larvae of *Ostrea edulis* (L.). *Journal of the Marine Biological Association of the United Kingdom* **37**: 415–425.
- Walne PR (1964) Observations on the fertility of the oyster (*Ostrea edulis*). *Journal of the Marine Biological Association of the United Kingdom* **44**: 293–310.
- Walne PR (1965) Observations on the influence of food supply and temperature on the feeding and growth of the larvae of *Ostrea edulis* L.. Anonymous, In: *Fishery Investigations Series II*, pp. 1–47. Her Majesty's Stationery Office, London.
- Walne PR (1970) Present problems in the culture of the larvae of *Ostrea edulis*. *Helgoländer Wissenschaftliche Meeresuntersuchungen* **20**: 514–525.
- Walne PR (1974) *Culture of Bivalve Molluscs: 50 Years Experience at Conwy*. Fishing News Books Limited, Surrey.
- Waugh GD (1964) Observations on the effects of chlorine on the larvae of oysters (*Ostrea edulis* (L.)) and barnacles (*Elminius modestus* (Darwin)). *Annals of Applied Biology* **54**: 423–440.
- Wendling CC, Batista FM, Wegner KM (2014) Persistence, seasonal dynamics and pathogenic potential of *Vibrio* communities from Pacific oyster hemolymph. *PLoS One* **9**: e94256.
- Wendling CC, Fabritzek AG, Wegner KM (2017) Population-specific genotype × genotype × environment interactions in bacterial disease of early life stages of Pacific oyster larvae. *Evolutionary Applications* **10**: 338–347.
- Wendling CC, Wegner KM (2015) Adaptation to enemy shifts: rapid resistance evolution to local *Vibrio* spp. in invasive Pacific oysters. *Proceedings of the Royal Society B: Biological Sciences* **282**: 20142244.
- Wilde A (1985) The food of starfish *Asterias rubens* L. on cultivated and derelict oyster fisheries. *Irish Naturalists' Journal* **21**: 528–532.
- Widdows J (1991) Physiological ecology of mussel larvae. *Aquaculture* **94**: 147–163.
- Wilson JH, Simons J (1985) Gametogenesis and breeding of *Ostrea edulis* on the west coast of Ireland. *Aquaculture* **46**: 307–321.
- Yang H, Simon N, Sturmer L (2018) Production and performance of triploid oysters for aquaculture. Anonymous, In: *UF/IFAS Extension FA208*, pp. 1–9. Institute of Food and Agricultural Sciences, University of Florida, Gainesville, FL.
- Yonge CM (1960) *Oysters. The New Naturalist*. Collins, London.
- Zapata-Restrepo LM, Hauton C, Williams ID, Jensen AC, Hudson MD (2019) Effects of the interaction between temperature and steroid hormones on gametogenesis and sex ratio in the European flat oyster (*Ostrea edulis*). *Comparative Biochemistry and Physiology Part A: Molecular & Integrative Physiology* **236**: 110523.
- Zolotarev PN, Terentyev AS (2012) Changes in the macrobenthic communities of the Gudauta oyster bank. *Oceanology* **52**: 231–237.
- Zrnčić S, Oraić D, Mihaljević Ž, Zanella D (2007) Impact of varying cultivation depths on growth rate and survival of the European flat oyster *Ostrea edulis*, L. *Aquaculture Research* **38**: 1305–1310.
- zu Ermgassen PSE, Bonačić K, Boudry P, Bromley CA, Cameron TC, Colsoul B et al. (2020a) Forty questions of importance to the policy and practice of native oyster reef restoration in Europe. *Aquatic Conservation: Marine and Freshwater Ecosystems* **30**: 2038–2049.
- zu Ermgassen P, van den Brink A, Bromley C, Brown J, Colsoul B, Fabra M et al. (2020b) Understanding biosecurity in native oyster restoration. In: zu Ermgassen P, Gamble C, Debney A, Colsoul B, Fabra M, Sanderson WG, Strand Å, Preston J (eds) *European Guidelines on Biosecurity in Native Oyster Restoration*, pp. 1–18. The Zoological Society of London, London.

## Supporting Information

Additional supporting information may be found online in the Supporting Information section at the end of the article.

**Appendix S1.** Detailed methods for data search.

**Appendix S2.** List of the 602 publications selected and analysed (update 12.2019).

**Appendix S3.** Table of the breeding programme and production records from 1987 at Rossmore Breeding Ponds.

**Appendix S4.** Synthesis of chronological cryopreservation operations of *Ostrea edulis* sperm (spermatozeugmata) from Vitiello et al. (2011) and Horváth et al. (2012).

**Appendix S5.** Summary of remote setting operations for *Ostrea edulis* according (and translated in English) to Guesdon et al. (1989), Carbonnier et al. (1990) and Coatanea et al. (1992).

**Appendix S6.** Glossary of some terms used in this review.

# Chapter II

## KEY FINDINGS

- ❖ *O. edulis* larvae have a preference for the substrate to which they attach, unlike other bivalve and oyster species.
- ❖ *Mytilus edulis* and *O. edulis* shells are the most preferred substrate types to produce *O. edulis* spat oysters in hatchery settings.
- ❖ Lime and clay are ideal inorganic materials to use for *O. edulis* spat production in hatchery settings (as an alternative to the use of shells).
- ❖ *O. edulis* larvae settle preferably on shell fragments in sandy sediments (not on stone fragments).
- ❖ Innovative 3D-sandstone reef structures show high a settlement response of *O. edulis* larvae.
- ❖ Clay, limed materials/substrates and bivalve shells are suitable substrate types to enhance recruitment in the field.
- ❖ Limed materials are attractive for larvae regardless of which shell material is coated.
- ❖ No significant differences in settlement preferences were observed within the categories of bivalve shells or inorganic materials (types of substrate) in the environment.
- ❖ *O. edulis* larvae do not successfully settle on (tested) wood materials.
- ❖ Differences in settlement preferences regarding substrate orientation were significant in hatchery experiments, but not in the field.
- ❖ Effects of inner and outer surface only apply for the settlement of *O. edulis* larvae on *M. edulis* shells.



# Chapter II

## ADDRESSING CRITICAL LIMITATIONS OF OYSTER (*OSTREA EDULIS*) RESTORATION: IDENTIFICATION OF NATURE-BASED SUBSTRATES FOR HATCHERY PRODUCTION AND RECRUITMENT IN THE FIELD

Bérenger Colsoul, Stéphane Pouvreau, Carole Di Poi, Simon Pouil, Verena Merk, Corina  
Peter, Maarten Boersma and Bernadette Pogoda

Published in *Aquatic Conservation: Marine and Freshwater Ecosystems*  
(2020; Open Access) / DOI: <https://doi.org/10.1002/aqc.3454>

Supplementary Material: Appendix II

**SPECIAL ISSUE ARTICLE**

# Addressing critical limitations of oyster (*Ostrea edulis*) restoration: Identification of nature-based substrates for hatchery production and recruitment in the field

Bérenger Colsoul<sup>1,2</sup> | Stéphane Pouvreau<sup>3</sup> | Carole Di Poi<sup>3</sup> |  
Simon Pouil<sup>4</sup> | Verena Merk<sup>1</sup> | Corina Peter<sup>1</sup> | Maarten Boersma<sup>1</sup> |  
Bernadette Pogoda<sup>1</sup>

<sup>1</sup>Biological Institute Helgoland, Alfred-Wegener-Institut Helmholtz-Zentrum für Polar- und Meeresforschung, Helgoland, Germany

<sup>2</sup>Faculty of Mathematics and Natural Sciences, Christian-Albrechts-Universität zu Kiel, Kiel, Germany

<sup>3</sup>UMR LEMAR 6539, IFREMER, Argenton, France

<sup>4</sup>Agence de Recherche pour la Biodiversité de La Réunion, La Réunion, France

**Correspondence**

Bérenger Colsoul, Biological Institute Helgoland, Alfred-Wegener-Institut Helmholtz-Zentrum für Polar- und Meeresforschung, Am Handelshafen 12, 27570 Helgoland, Germany.  
Email: berenger.colsoul@awi.de

**Funding information**

German Federal Agency for Nature Conservation, Grant/Award Number: FKZ 3516892001

**Abstract**

1. The European flat oyster (*Ostrea edulis*) is an ecosystem engineer that provides important biogenic reef habitat with associated ecosystem functions and services. Most stocks have been commercially exploited and degraded; some are functionally extinct. Ecological restoration now aims to recover these degraded, damaged or destroyed ecosystems.
2. Availability of seed oysters and substrate for successful larval recruitment has been identified as a major limiting factor for restoration projects in Europe. In substrate-limited areas, restoration approaches have to involve the restoration of suitable substrates.
3. The present study provides an evaluation of such potential substrate types. Various categories were investigated through hatchery and/or field experiments: (1) marine bivalve shells; (2) inorganic materials; (3) sandy sediment; (4) 3D sandstone reefs; (5) wood materials; and (6) limed materials. The respective settlement rates (settled larvae per cm<sup>2</sup>) indicate settlement preferences.
4. Hatchery experiments showed significant preferences for bivalve shells and inorganic materials. Best settlement rates were observed on *Mytilus edulis* shells, followed by *O. edulis* shells as well as on slaked lime and on baked clay. Settlement was significantly higher on bottom-oriented areas of bivalve shells and 3D reefs in laboratory experiments; however, this was not substantiated in the field experiments.
5. Field experiments showed significant settlement preferences between substrate categories (bivalve shells, inorganic materials and wood materials). Best settlement rates were observed on baked clay, followed by slaked lime and bivalve shells. Wooden materials did not perform.
6. Settlement rates and substrate preferences of larvae in controlled environments (laboratory, hatchery) differed from rates in the natural environment (field). This

This is an open access article under the terms of the Creative Commons Attribution-NonCommercial-NoDerivs License, which permits use and distribution in any medium, provided the original work is properly cited, the use is non-commercial and no modifications or adaptations are made.

© 2020 The Authors. Aquatic Conservation: Marine and Freshwater Ecosystems published by John Wiley & Sons Ltd

study provides a list of substrate types considering these specific environments. The relevance of these results for ecological restoration in the field and potential applications in seed oyster production are discussed.

#### KEYWORDS

coastal, invertebrates, restoration, settlement, substrates

## 1 | INTRODUCTION

The European flat oyster (*Ostrea edulis*) is an ecosystem engineer, forming biogenic reef habitats and thus providing various ecosystem functions and services (Pogoda et al., 2019). Its natural distribution ranges from Norway to Morocco, where it was once abundant not only along the coast, but also in sublittoral waters (Kerckhof, Coolen, Rumes, & Degraer, 2018). The species has been used as a food source for more than 3,000 years and has been exploited extensively since the eighteenth century all over Europe, resulting in severe population declines in many European regions (Thurstan, Hawkins, Raby, & Roberts, 2013; Voultsiadou, Koutsoubas, & Achparaki, 2010). In Germany, the species is listed as functionally extinct since the 1950s. With the extirpation of this habitat builder, the ecological key-functions of a living species-rich oyster habitat were also lost (Pogoda, 2019).

Today, the ecological restoration of *O. edulis* habitats is being addressed by a number of projects in Europe (Pogoda et al., 2019). The restoration of this species and of both oyster habitats and biogenic reefs contributes to the achievement of objectives defined under the OSPAR Convention for the Protection of the Marine Environment of the North-East Atlantic, under the EU Habitats Directive (Directive 92/43/EEC) and under the EU Marine Strategy Framework Directive (Directive 2008/56/EC); (Pogoda, Merk, et al., 2020). It is also part of a more general approach to the conservation and restoration of biodiversity as such in response to the current global crisis (Vogel, 2017).

Restoration areas can be either recruitment limited or substrate limited, or both (Westby, Geselbracht, & Pogoda, 2019). The number of larvae ready for settlement and the availability of appropriate substrates are among the main factors determining recruitment success in oyster populations (Abbe, 1988; Korringa, 1946a; MacKenzie, 1970). Accordingly, successful restoration of biogenic oyster reefs will clearly depend on detailed knowledge of larval settlement mechanisms and preferences, and on the availability of suitable substrates (Cole & Knight Jones, 1939; Korringa, 1946b; Rodriguez-Perez et al., 2019; Smyth, Mahon, Roberts, & Kregting, 2018). *Ostrea edulis* larvae are pelagic for a period of 6–14 days (depending mainly on water temperature), after which settlement occurs with larvae selecting and attaching to a solid substratum and consequently metamorphosing into spat (Bayne, 2017).

The settlement mechanism of *O. edulis* larvae is influenced by a number of physiological and environmental (abiotic and biotic) factors. Several relevant factors according to the literature are listed here in

no particular order of importance: (1) general physiological status of larvae (Cranfield, 1973; Robert, Vignier, & Petton, 2017); (2) temperature (Davis & Calabrese, 1969; Marteil, 1976); (3) pH (Carbonnier et al., 1990; Cole & Knight Jones, 1949); (4) light (Bayne, 1969; Bracke & Polk, 1969; Walne, 1974); (5) hydrodynamics (Helm & Spencer, 1972; Korringa, 1940); (6) substrate type and composition (Cole & Knight Jones, 1949; Guesdon, Le Bec, Mazurie, & Lassale, 1989; Korringa, 1976); (7) orientation angles and shape of the substrate (Carbonnier et al., 1990; Cole & Knight Jones, 1949; Guesdon et al., 1989; Korringa, 1976); (8) colour and transparency of substrates (Cole & Knight Jones, 1949; Herman, 1937; Walne, 1974); (9) biofilm and fouling (Carbonnier et al., 1990; Cole & Knight Jones, 1949; Korringa, 1940; Walne, 1958); and (10) presence of conspecifics (Cole & Knight Jones, 1949; Rodriguez-Perez et al., 2019).

Substrate characteristics are in the focus of this study as they play an important role in practical ecological restoration (Fitzsimons et al., 2020). Abiotic factors are usually considered within the process of restoration site selection (Kamermans et al., 2018; Pogoda, Merk, et al., 2020). Substrate-limited areas lack natural reef structure to which oyster larvae can attach and restoration will include the selection and supply of optimal substrates (Westby et al., 2019). Focusing on the quality and suitability of substrate for ecological restoration, this study addresses open questions related to factors (6) substrate types and composition and (7) orientation angles and shape of substrate. Biotic factors, e.g. biofilm, fouling and conspecifics, were not addressed in this study.

Previous studies, focusing on substrate suitability, were carried out under different conditions (laboratory vs. field), at different locations, scales and times (Cole & Knight Jones, 1949; Coste, 1861; Smyth et al., 2018), which limits comparison between them. Additionally, these studies mainly addressed the needs of aquaculture production (spat collection) and investigated traditional local substrates such as bivalve shells or plant-based substrates (Benovic, 1997; Gaarder & Bjerkan, 1934; Korringa, 1976) and easy-to-use settlement supports such as artificial collectors (Coatanea, Oheix, Mazzara, & Hamon, 1992; Guesdon et al., 1989; Hidu, Chapman, & Soule, 1975; Korringa, 1976; Locard, 1900; Naas, 1991) instead of nature-based materials appropriate for restoration.

In the new context of ecological restoration, the suitability of different substrate types for *O. edulis* settlement needs to be re-evaluated altogether, under both laboratory and field conditions. Furthermore, substrates used in the past did not take into account relevant modern sustainability criteria such as the prevention of spread of invasive species, diseases or pathogens via substrate

transfer, or the environmentally responsible sourcing of substrates. Accordingly, within this study, these additional criteria were considered to address the needs of sustainable and large-scale restoration efforts. The objective of this study was to investigate the settlement preferences of *O. edulis* larvae through combined laboratory (hatchery) and field approaches. Six substrate categories comprising 20 substrate types were examined, from historically used wood and abundantly available shell material to highly innovative 3D-printed sandstone structures. The results provide practical information for the selection of substrate for (1) ecological restoration of *O. edulis* in substrate-limited areas and (2) systematic hatchery-based seed oyster production for ecological restoration of *O. edulis* in recruitment-limited areas.

## 2 | METHODS

Assessments of substrate preferences for the settlement of *O. edulis* larvae were conducted through three separate experiments. The first two were performed in a hatchery under controlled experimental conditions and aimed at comparing settlement preferences among three categories of substrates (empty marine bivalve shells, inorganic materials and sandy sediments) and assessing the applicability of innovative 3D-printed structures as a settlement substrate under similar conditions. The third experiment consisted of deploying potential settlement substrates at suitable field sites during the natural swarming season of *O. edulis* larvae.

Substrate types were selected based on the following criteria, reflecting the focus of ecological restoration against the background of nature conservation measures:

1. Natural materials – artificial materials, e.g. plastics or concrete, with potential negative effects on the environment (marine litter, microplastic, chemical pollution) were not considered and not tested in the study. Only natural or nature-based materials were selected (shells, lime, clay, stone). Furthermore, existing substrates at designated restoration sites were tested (sandy sediments, granite).
2. Sustainably sourced – abundant bivalve shells, available from aquaculture or fisheries and industrially processed in many areas in Europe, were selected, allowing for sustainable sourcing of substrates without negative impacts on natural substrates. Furthermore, comparing settlement preferences between the shells of *O. edulis* and other bivalve species may provide information supporting the possible spread of *O. edulis* reefs. Inorganic materials (lime and clay) also offer a quantitative (stable and substantial supply) and qualitative alternative without negative impacts on natural substrates.
3. Knowledge transfer and common sense – different collector types successfully used in aquaculture production for seed collection were selected (bivalve shells, lime). Furthermore, wood was tested as historical records document successful settlement (Coste, 1861; Gaarder & Bjerkan, 1934; Korringa, 1976).
4. Technical innovation potential – 3D-ReefVival-Experimental-Reefs<sup>®</sup> made from sandstone (dolomite) were selected to test

environmentally friendly reef ball structures, avoiding the further input of concrete (i.e. containing adjuvants) structures into the marine environment. At offshore sites, e.g. the designated oyster restoration area Borkum Reef Ground, sediment movements, including silt and sand waves, may affect future spat recruitment (Cole & Knight Jones, 1949; Kamermans et al., 2018; Pogoda, Merk, et al., 2020). Elevated massive 3D-structures would decrease the potential negative effects of sediment dynamics (Sawusdee, Jensen, Collins, & Hauton, 2015). Electrolytic mineral accretion (EMA) was selected as an additional innovative substrate type, already successfully implemented in coral reef restoration (Goreau, 2012; Goreau & Trench, 2012; van Treeck & Schuhmacher, 1997). The deposition of natural  $\text{CaCO}_3$  on steel structures allows the formation of complex 3D structures as settlement surfaces.

### 2.1 | Experiment 1 (hatchery)

#### 2.1.1 | Larval origin

Eye-spotted larvae (7 days post-swarming with mean size of  $264.60 \pm 13.43 \mu\text{m}$ ) of *O. edulis* were purchased in July 2017 from a commercial hatchery (Ferme Marine de l'île d'Arun EARL, Hanvec, France) and transferred to the research hatchery of Ifremer, Argenton en Landunvez (France) for experiments.

#### 2.1.2 | Substrate types

Three categories of substrates were investigated: empty marine bivalve shells, inorganic materials and sandy sediment. The first category c-shells included shells of four species: *Crassostrea gigas*, *Mytilus edulis*, *O. edulis* and *Pecten maximus*. Prior to experimentation, shells were cleaned and sterilized in a chlorine bath in order to study the effects of the substrate and not of the potential biofilms growing on them. The second category c-inorganics included four inorganic substrates: EMA as commonly used in coral reef restoration; baked clay and slaked lime as natural products commonly used in mariculture; and granite as an abundant natural stone material in the marine environment. Electro-mineral accretion grid plates were manufactured according to the process described by Taylor (2011). Baked clay was produced by Korallenwelt<sup>®</sup>, Germany (composition detailed in Table S1). Slaked lime produced from magnesium–calcite hydrated lime powder (Figure S1) supplied by Lhoist France Ouest SASU (Neau, France) and seawater was applied to a tile surface. Granite pieces were collected on the Argenton en Landunvez foreshore. The third category c-sediments included sandy sediments of three different size classes (International scale ISO 14688-1:2002): fine and medium sand ( $>0.063$  to  $\leq 0.63$  mm), coarse sand ( $>0.63$  to  $\leq 2.0$  mm) and fine gravel ( $>2.0$  to  $\leq 6.3$  mm), collected from the marine protected area Borkum Reef Ground ( $53^\circ 52' 59''\text{N}$   $6^\circ 25' 08''\text{E}$ ), an important target area for European flat oyster restoration pilots in the German Bight (Pogoda et al., 2019; Pogoda, Merk, et al., 2020). These sandy sediments were dried and glued to PVC sheets.

### 2.1.3 | Experimental setup

For each category, all substrate types were placed in sieves (44 × 35 × 14 cm, mesh size 150 μm). Sieves from each category were placed in rectangular tanks (depth 20 cm, Figure 1) with a flow-through system (down-welling), and supplied with natural seawater taken directly from the sea (filtered to 1 μm and UV sterilized) at a rate of  $8.60 \pm 0.85 \text{ L h}^{-1}$ . Experiments were run in triplicate in three individual tanks. All substrates were positioned and trimmed to cover a surface area of 212 cm<sup>2</sup> each. For shells, upper-surface (all outer-shells here) and bottom-side (all inner-shells here) were examined. In c-shells and c-inorganics,  $N = 35,000$  larvae (from the same batch of larvae) were placed all at once and randomly in each sieve at a density of  $\sim 2,273$  larvae L<sup>-1</sup>. In c-sediments,  $N = 10,500$  larvae (from the same batch) were applied at a lower density of  $\sim 682$  larvae L<sup>-1</sup> (owing to a logistical issue in larval supply). Larvae were added immediately after their arrival and fed continuously by peristaltic pumps that mixed the algae with filtered seawater at the inlet of each tank, with a bispecific diet (1:1) consisting of *Tisochrysis lutea* and *Chaetoceros muelleri* with a food density of  $1,000 \mu\text{m}^3 \mu\text{l}^{-1}$ . Seawater at the inlet and outlet of each experimental tank was sampled twice a day (morning and afternoon) and microalgae counts were performed using an electronic particle counter (Multisizer™3 equipped with a 100 μm aperture). Adjustments were then made to the feeding rate to keep the algal cell density constant. Temperature ( $20.87 \pm 0.07^\circ\text{C}$ ), pH ( $8.40 \pm 0.06$ ), salinity ( $35.75 \pm 0.08$ ) and dissolved oxygen ( $89.88 \pm 11.51 \%$ ) were monitored and adjusted to optimal conditions twice a day. The experiment was ended after a

settlement period of one week by carefully removing the substrates from the water, gently cleaning with fresh water, drying and storing them (in independent plastic bags between air bubble films at 18°C) for the counting of settled larvae.

## 2.2 | Experiment 2 (hatchery)

### 2.2.1 | Larval origin

Eye-spotted larvae (6 days post-swarming) of *O. edulis* were produced in the period from July to August 2018 in a commercial hatchery (Novostrea Bretagne SAS, Sarzeau, France) from local broodstock.

### 2.2.2 | Substrate type

The 3D-sandstone reefs (3D-ReefVival-Experimental-Reefs® designed by Reef Design Lab®) were printed by Boskalis Nederland BV using the following ingredients: dolomite sand, trass flour (Tubag™), white cement (Standard EN 197-1:2011, CEM I/II) and fresh tap water (Table S2). The reefs consisted of four round and horizontal platforms supported by pillars (Figure 2). The dimensions of the reefs were 50 cm in height and 50 cm in diameter.

### 2.2.3 | Experimental setup

Settlement experiments were carried out using two structurally identical reefs. Each reef was placed in a cylindrical tank (400 L)

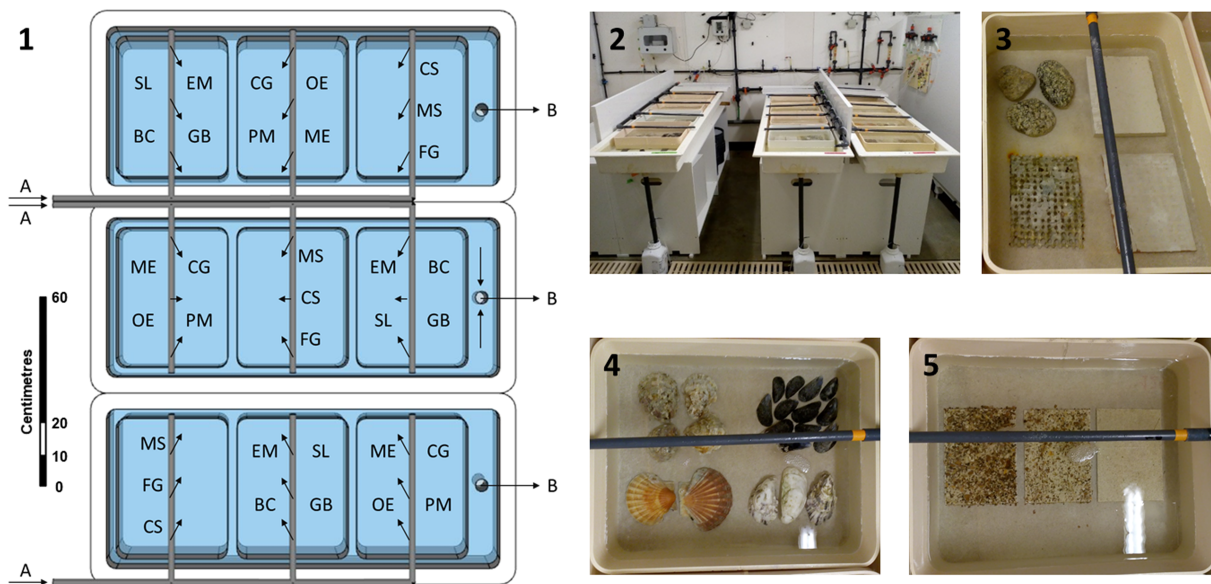

**FIGURE 1** Experimental design and set up of settlement experiments for *Ostrea edulis* larvae in the hatchery. (1) Schematic view of the basins and sieves from above, including the layout of the substrate types; (2) profile photograph of the experimental basins and sieves; sieves with (3) inorganic substrates; (4) bivalve shells; and (5) sandy sediments. Abbreviations: A = Inlet of water and feed; B = water outlet by overflow; BC = baked clay; CG = *Crassostrea gigas* shells; CS = coarse sand; EM = electrolytic mineral accretion; FG = fine gravel; GB = granite; ME = *Mytilus edulis* shells; MS = medium/fine sand; OE = *O. edulis* shells; PM = *Pecten maximus* shells; SL = slaked lime on tile. See Section 2.1.3 for more details regarding the dimensions of the setup

**FIGURE 2** Schematic views of 3D-ReefVival-Experimental-Reefs<sup>®</sup> tested as settlement substrate for *O. edulis* in hatchery experiment 2: (1) horizontal section of one tray and (2) a profile view of the whole reef. Dark areas represent examined substrate surface (only in this scheme); tested reefs were all white. Abbreviations: A = Data acquisition area; BO = bottom-oriented area (bottom-side); C = hollow centre of the reef; P = pillars located between the different strata; SO = surface-oriented area (upper-surface)

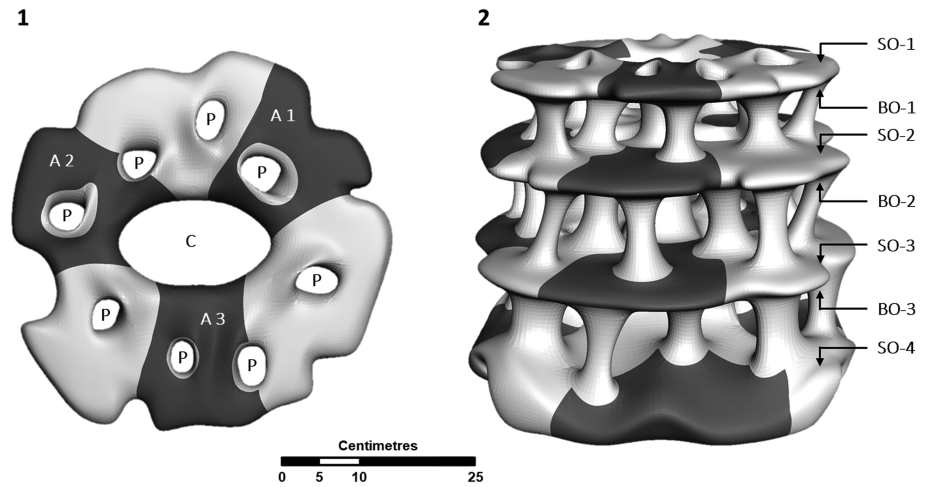

with flow-through systems. In each tank  $N = 500,000$  larvae were placed at a density of  $\sim 1,250$  larvae  $L^{-1}$ . Food composition, food concentration and settlement duration were consistent with experiment 1. Temperature, pH and salinity were monitored daily and were in the ranges 21–23°C, 7.5–8.5 and 34–36, respectively. Dissolved oxygen was not monitored. The flow-through system (downwelling) was supplied with natural seawater filtered to 1  $\mu m$  and UV sterilized at a rate of 5  $L h^{-1}$ .

## 2.3 | Experiment 3 (field)

As the field study was carried out after the hatchery experiments, the selection of substrates was adapted accordingly. The low settlement response of *O. edulis* larvae on *P. maximus* shells, EMA and granite in the laboratory led to their exclusion from the third experiment. Sandy sediments and 3D-sandstone reefs were not included for logistical reasons. Nevertheless, considering historical information, wood materials were tested in the field (Coste, 1861; Gaarder & Bjerkan, 1934; Korringa, 1976). Additionally, and in order to determine whether substrate shape affects settlement response, five different substrate types were coated with slaked lime.

### 2.3.1 | Study area and larval origin

*In situ* tests were carried out at Roz Bank, Daoulas Cove (48°19'29" N 4°19'26" W), a natural *O. edulis* bed in the Bay of Brest, France. The experimental structures were installed at 5.8 m water depth. Larval abundance at Roz Bank has been monitored since 2012 using the protocol presented by Pouvreau (2015). Based on results and observations of previous years, the maximum larval abundance and recruitment period were estimated for mid-July 2018, and settlement substrates were deployed in that period. Chlorophyll concentration, salinity, temperature and turbidity were monitored daily.

### 2.3.2 | Substrate types

Four substrate categories were tested: c-shells (*C. gigas*, *M. edulis*, and *O. edulis*), c-inorganics (slaked lime on tile, baked clay), c-woods (*Juniperus communis*, *Picea abies* and *Phyllostachys edulis*) and c-limed, shells (*C. gigas*, *M. edulis* and *O. edulis*) and woods (*P. edulis* and *P. abies*) coated with slaked lime.

### 2.3.3 | Experimental setup

Field experiments were started at the larval peak and were carried out in three supports (50 × 50 cm) moored 10 cm above the seafloor. Each support had 13 horizontal experimental positions (9.5 × 9.5 cm) for attaching different substrate types (Figure 3). Triplicates were prepared for each substrate type and placed randomly in each support. Shells were glued on tiles (9.5 × 9.5 cm): upper-surface and bottom-side settlement preferences of larvae were investigated by attaching shells to both sides of the tiles (Figure 4). For *C. gigas* and *O. edulis*, two shell valves were attached on each tile side. For *M. edulis*, six shell valves were used with three placed with the convex side facing the tile (outer surface of the shell) and three facing up (inner surface of the shell) on each side of the tiles. Inorganic substrates and wood (*P. abies* and *J. communis*) were cut to size (9.5 × 9.5 cm). Tiles were coated with slaked lime and dried prior to deployment. *Phyllostachys edulis* was vertically cut in half and four halves were fitted into each of the designated experimental positions, two facing with the convex side up and two facing down. Limed materials were positioned in the same way as the non-limed material, but coated with slaked lime and dried prior to deployment.

After the experimental period of 14 days, corresponding to the maximum swarm peak period in July 2018 (Pouvreau, Cochet, Gachelin, Chaudemanche, & Fabien, 2019), substrates were brought to the surface, gently cleaned with fresh water, dried and stored (in independent plastic bags between air bubble films at 18°C) for the counting of settled larvae.



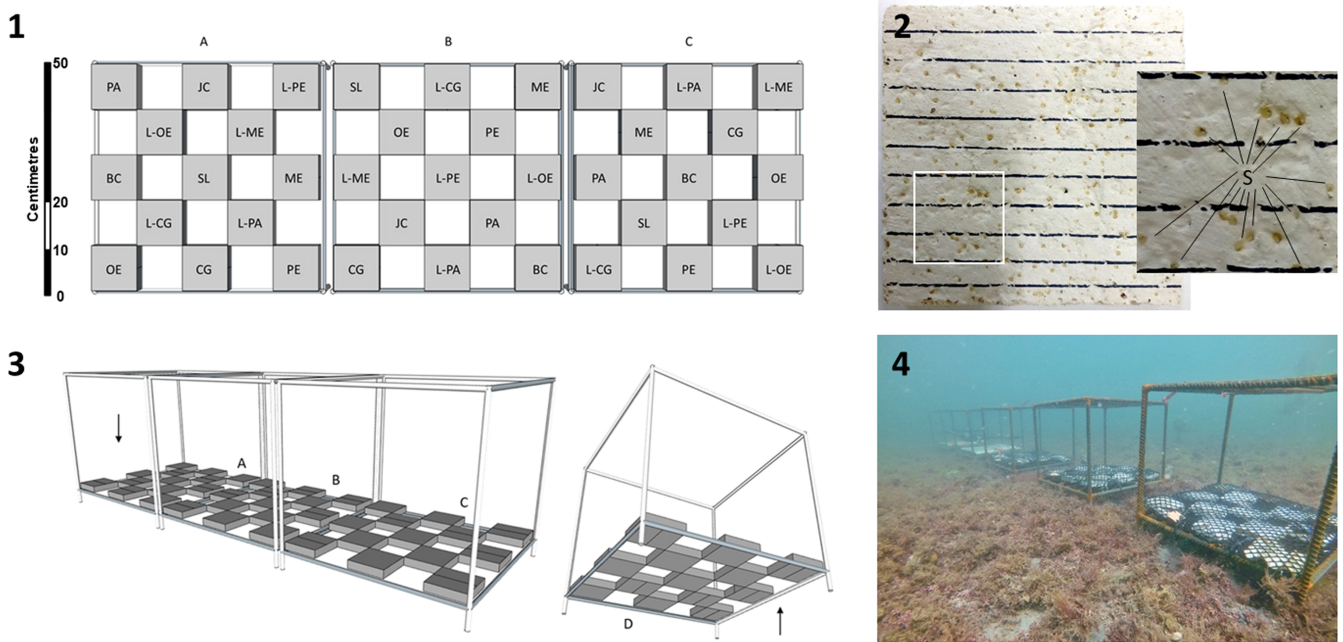

**FIGURE 3** Experimental design and set up of settlement experiments for *O. edulis* larvae in the field. (1) Schematic view of the layout of the substrates tested in supports. (2) Picture illustrating an example of one substrate (here baked clay) tested with an enlargement highlighting several larvae (in yellow) settled on a white background (baked clay) between black lines added after the test for counting. (3) Two schematic profile views of the supports used, including the substrates, highlighting the two orientations (i.e. surface and bottom) of each substrate. (4) Underwater photography of experimental structures. Abbreviations: A–C = surface-oriented areas of the three replicates; BC = baked clay; CG = *C. gigas* shells; D = bottom-oriented areas of one of the replicates; JC = *Juniperus communis*; L-CG = coated *C. gigas* shells with slaked lime; L-ME = coated *M. edulis* shells with slaked lime; L-OE = coated *O. edulis* shells with slaked lime; L-PA = coated *Picea abies* with slaked lime; L-PE = coated *Phyllostachys edulis* with slaked lime; ME = *M. edulis* shells; OE = *O. edulis* shells; PA = *P. abies*; PE = *P. edulis*; S = settled larvae; SL = slaked lime. See Section 2.3.3 for more details regarding the dimensions of the setup

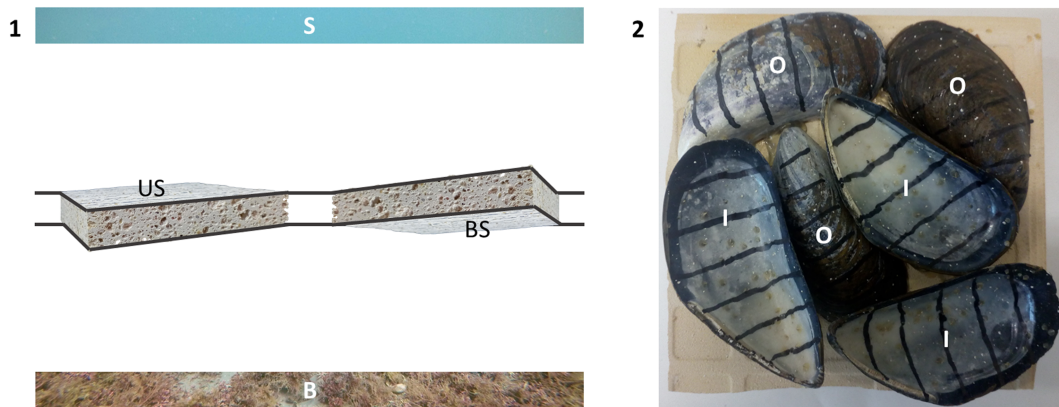

**FIGURE 4** Illustrations of the different orientations and surfaces tested. (1) Schematic view of the two orientations on an example substrate (here baked clay). (2) Schematic view of the two types of shell surfaces (here *M. edulis*). Abbreviations: B = bottom; BS = bottom-side/bottom-oriented; I = inner-shell/inside of the valve; O = outer-shell/outside of the valve; S = water surface; US = upper-surface/surface oriented

## 2.4 | Data collection and treatment

### 2.4.1 | Counting of settled larvae

For experiments 1 and 3, the total number of settled larvae on the tested substrates was counted using a stereomicroscope (Zeiss™

Stemi™ DV4) with a magnification of 32× (Figure 3(2)). For experiment 2, photographs were taken with an ultra-high definition (4K) camera (Nikon™ Coolpix™ W300), with a positioned scale bar. Owing to the specific shape of 3D-ReefVival-Experimental-Reefs®, 780 ± 4.97 cm<sup>2</sup> of each replicate reef, corresponding to 40% of each horizontal settlement area (Figure 2), was counted. All data

from each of the experiments are reported in larvae per cm<sup>2</sup> (Table 1). Larval losses during experiments 1 and 2 were determined by subtracting the total number of settled larvae from the initial number of seeded larvae.

## 2.4.2 | Statistical analysis

For experiment 1, the differences between the total numbers of settled larvae on all of the tested substrates were determined within each category. Each substrate category was studied in a separate tank and statistical comparisons were only done within each substrate category. For each substrate category (e.g. c-shells, c-inorganics and c-sediments), count data were analysed using negative binomial generalized linear models (Poirier et al., 2019). Negative binomial generalized linear models (selected based on the lowest AIC values) were fitted for each substrate category. For all substrate categories, model structure included substrate type as a fixed effect, and the inclusion of the shell orientation (bottom-side or upper-surface) was added as an additional fixed effect for c-shells. All statistical analyses were performed using R version 3.5.2 (R-Development-Core-Team, 2018) using the 'lme4' package and *post-hoc* tests were completed using the 'emmeans' package (Bates, Mächler, Bolker, & Walker, 2015; Lenth et al., 2018; Lüdtke, 2018). *Post-hoc* test results were fitted with the log scale.

For experiment 3 (field study), independent data were tested for normality (Shapiro's test) and homogeneity of variances (Levene's test). One-way ANOVAs followed by Tukey's tests were then used to determine significant differences among the different substrate types. Effects of substrate orientation (upper-surface or bottom-side orientation) were tested using a one-way ANOVA (c-shells and c-woods) and a Student's t-test (c-inorganics). In c-shells, the effects of shell surface (inner or outer) were tested using a one-way ANOVA followed by Tukey's tests. The level of significance for statistical analyses was always set at  $\alpha = 0.05$ .

**TABLE 1** Results of the second hatchery experiment on settlement preference of *Ostrea edulis* larvae on 3D-ReefVival-Experimental-Reefs®

Orientation and layers (see Figure 2)	Reef 1 (settled larvae per cm <sup>2</sup> )	Reef 2 (settled larvae per cm <sup>2</sup> )
SO-1	1.54 ± 0.48	1.59 ± 0.61
BO-1	7.63 ± 2.41	4.53 ± 1.70
SO-2	1.28 ± 0.46	1.14 ± 0.71
BO-2	5.10 ± 2.13	5.51 ± 2.55
SO-3	1.04 ± 0.59	1.51 ± 0.97
BO-3	2.91 ± 1.03	9.21 ± 2.38
SO-4	1.30 ± 0.50	0.41 ± 0.08

Abbreviations: BO = bottom oriented (bottom-side); SO = surface oriented (upper-surface).

## 3 | RESULTS

### 3.1 | Hatchery experiments

Settlement preferences differed significantly for the tested substrate types within c-shells and c-inorganics (Table 2 and Figure 5). In c-shells, *M. edulis* shells (29.1 ± 3.3 larvae per cm<sup>2</sup>; mean ± SD) and, to a lesser extent, *O. edulis* shells (17.7 ± 3.6 larvae per cm<sup>2</sup>) were significantly preferred by *O. edulis* larvae while lower settlement was observed on *C. gigas* shells (10.0 ± 3.0 larvae per cm<sup>2</sup>) and on *P. maximus* shells (9.5 ± 3.3 larvae per cm<sup>2</sup>) (Figure 5). In c-inorganics, the highest settlement was observed on slaked lime (30.3 ± 10.7 larvae per cm<sup>2</sup>) and baked clay (15.3 ± 6.3 larvae per cm<sup>2</sup>), with no significant differences between those two substrate types ( $z$  value = -2.485,  $P = 0.062$ ). Settlement was very low on EMA (3.4 ± 2.9 larvae per cm<sup>2</sup>) and on granite (0.5 ± 0.4 larvae per cm<sup>2</sup>). In c-sediments, the mean number of settled larvae per cm<sup>2</sup> was lower than for inorganic and bivalve shell substrates (Figure 5). Furthermore, no significant difference was observed for the different grain size classes (Table 2 and Figure 5) within this category. The larvae mainly settled on the shell fragments, whereas sand and gravel grains were less attractive for settlement (Figure S2). The average number of settled larvae in c-sediments (i.e. initial larvae density of ~682 larvae L<sup>-1</sup>) ranged from 3.4 ± 0.8 to 6.3 ± 6.3 larvae per cm<sup>2</sup>, while the settlement ranged from 9.5 ± 3.3 to 29.1 ± 3.3 larvae per cm<sup>2</sup> and from 0.5 ± 0.4 to 30.3 ± 10.7 larvae per cm<sup>2</sup> in c-shells and c-inorganics (i.e. initial larvae density of ~2,273 larvae L<sup>-1</sup>), respectively. The proportions of non-settled larvae in experiment 1 were 59.7 ± 5.5% (mean ± SD) in c-shells, 70.0 ± 6.2%, in c-inorganics and 70.9 ± 18.7% in c-sediments, respectively.

In addition to the effects of substrate types on settlement preference of larvae, the effects of shell orientation were also assessed within c-shells (upper-surface vs. bottom-side orientation, irrespective of inner or outer surface of the valves) (Table 2). A significant preference for bottom-oriented shells ( $z$  value = -9.098,  $P < 0.0001$ ) was observed for all shell types (*C. gigas*, *M. edulis*, *O. edulis* and *P. maximus*). This effect was particularly pronounced for *M. edulis* shells, where 28.1 ± 2.8 larvae per cm<sup>2</sup> settled on bottom-oriented shells, while only 1.0 ± 0.6 larvae per cm<sup>2</sup> settled on the upper-surface of the shells (Figure 6).

In experiment 2, the average settlement on the reefs ranged from 0.41 ± 0.08 to 9.22 ± 2.38 larvae per cm<sup>2</sup> (Table 1). Only 40% of the horizontal reef surface was examined and as no swimming larvae and no settlement were observed on the experimental tanks (visual observations), larvae were obviously attracted by this type of substrate. Furthermore, the positions of the settled larvae (upper-surface vs. bottom-side) clearly indicate the preference for bottom orientation (5.7 ± 2.4 larvae per cm<sup>2</sup>) compared with the upper surface (1.2 ± 0.4 larvae per cm<sup>2</sup>). As experiment 2 was conducted in duplicate, no statistical analysis was performed on the data gathered from artificial reefs.



**TABLE 2** Results of negative binomial generalized linear models for counts of *O. edulis* spat for the first laboratory experiment assessing the settlement substrate preferences

Response: Counts	Estimate	SE	z Value	P-Value
<i>Substrate category: shells</i>				
Intercept	2.1746	0.1842	11.807	<0.0001
<i>M. edulis</i>	1.0660	0.2113	5.045	<0.0001
<i>O. edulis</i>	0.5683	0.2281	2.492	0.0127
<i>P. maximus</i>	-0.0582	0.2616	-0.223	0.8239
Shell faces	-1.9600	0.2154	-9.098	<0.0001
<i>Contrasts</i>				
<i>C. gigas</i> - <i>M. edulis</i>	-1.0660	0.211	-5.045	<0.0001
<i>C. gigas</i> - <i>O. edulis</i>	-0.5683	0.228	-2.492	0.0612
<i>C. gigas</i> - <i>P. maximus</i>	0.0582	0.262	0.223	0.9961
<i>M. edulis</i> - <i>O. edulis</i>	0.4976	0.174	2.861	0.0220
<i>M. edulis</i> - <i>P. maximus</i>	1.1242	0.216	5.205	<0.0001
<i>O. edulis</i> - <i>P. maximus</i>	0.6265	0.232	2.696	0.0354
<i>Substrate category: inorganic</i>				
Intercept	2.7270	0.2082	13.098	<0.0001
EMA	-1.5090	0.4043	-3.732	0.0002
Granite	-3.4942	0.8848	-3.949	<0.0001
Slaked lime	0.6845	0.2755	2.485	0.0130
<i>Contrasts</i>				
Baked clay-EMA	1.509	0.404	3.372	0.0011
Baked clay-granite	3.494	0.885	3.949	0.0005
Baked clay-slaked lime	-0.685	0.275	-2.485	0.0623
EMA-granite	1.985	0.927	2.141	0.1402
EMA-slaked lime	-2.194	0.391	-5.614	<0.0001
Granite-slaked lime	-4.179	0.879	-4.756	<0.0001
<i>Substrate category: sediments</i>				
Intercept	1.8377	0.3502	5.247	<0.0001
Fine gravel	-0.3037	0.5139	-0.591	0.555
Medium/fine sand	-0.6018	0.5377	-1.119	0.263
<i>Contrasts</i>				
Coarse sand-fine gravel	0.304	0.514	0.591	0.8250
Coarse sand-medium/fine sand	0.602	0.538	1.119	0.5021
Fine gravel-medium/fine sand	0.298	0.555	0.537	0.8530

Note: The reference (intercept) category/substrates are *Crassostrea gigas*/bottom, baked clay, coarse sand for bivalve shells, inorganic substrates and sedimentary substrates, respectively. Marginal contrasts are provided. Results are given on the log scale.

### 3.2 | Field experiment

In the field, salinity and temperature were stable over the entire period, with mean values of  $34.40 \pm 0.14$  and  $19.93 \pm 0.12^\circ\text{C}$ ,

respectively. The chlorophyll concentration was on average  $1.24 \pm 0.07 \mu\text{g L}^{-1}$  and turbidity was  $0.62 \pm 0.07$  NTU. As all substrate types were tested in one experimental setup at the same time, a direct comparison of settlement response of all respective substrate types was possible (Figure 7). Wild *O. edulis* larvae preferred substrates from c-inorganics. A significant effect of substrate type was found ( $F = 48.44$ ,  $P < 0.0001$ ) for all inorganic substrates, especially baked clay ( $4.1 \pm 0.5$  larvae per  $\text{cm}^2$ ), compared with c-shells ( $2.4 \pm 0.5$  larvae per  $\text{cm}^2$ ) and c-woods ( $0.2 \pm 0.1$  larvae per  $\text{cm}^2$ ) (Figure 7). Within all three substrate categories, Tukey's test revealed no significant difference among the substrate types within the category tested (Figure 7). c-Woods shows by far the lowest rate of larval settlement with differences of ~12- and ~20-fold lower than c-shells and c-inorganics, respectively.

In contrast to the laboratory experiments, no significant effect of substrate orientation (upper-surface and bottom-side) was observed in the field ( $F = 1.872$ ,  $P = 0.173$  for bivalve shells;  $F = 2.626$ ,  $P = 0.126$  for inorganic materials and  $F = 1.619$ ,  $P = 0.229$  for wooden substrates; Figure 8). Settlement preference may also be related (irrespective of upper-surface and bottom-side orientation) to inner and outer shell surface ( $F = 5.14$ ,  $P = 0.002$ , Figure 9): *O. edulis* settling on *M. edulis* shells showed a significantly higher settlement on the inner surface ( $P < 0.0001$ ). Nevertheless, no difference was observed for *C. gigas* shells ( $P = 0.919$ ) and *O. edulis* shells ( $P = 0.952$ ) (Figure 9).

Settlement results of *O. edulis* on wooden substrates coated with slaked lime were not reliable enough to be analysed. The slaked lime did not attach itself sufficiently to the material. However, no significant differences in settled larvae rates were observed between the other substrate types within c-limed, nor with the slaked lime on tile for c-inorganics (Figure S3).

## 4 | DISCUSSION

In 2017, the Native Oyster Restoration Alliance was founded to support and facilitate the ecological restoration of biogenic oyster reefs throughout Europe. The network identified several critical issues which currently limit sustainable large-scale restoration operations and outlined recommendations for ecological oyster restoration (Pogoda et al., 2019), e.g. to provide suitable substrates for successful recruitment (recommendation 3), as adding or introducing suitable substrates in restoration sites will increase recruitment success. Accordingly, this study focused on the identification of suitable substrate types, either for practical restoration in the field or to produce sufficient oysters for restoration of oyster reefs (recommendation 1).

For the first time, an experimental setup was created to observe settlement preferences of *O. edulis* in both controlled and natural environments with different substrate types. The results confirm that *O. edulis* larvae show settlement preferences depending on the type of substrate, and unexpectedly, these preferences differ between controlled and natural conditions.

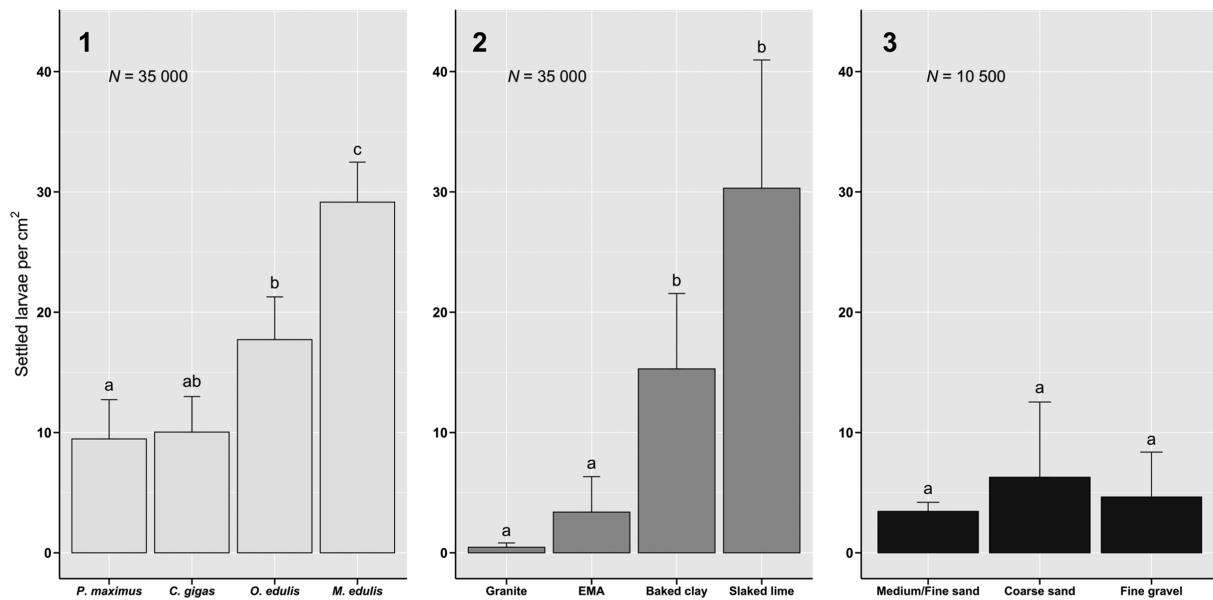

**FIGURE 5** Settlement preference of *O. edulis* larvae on different substrate types in experiment 1 (hatchery): 1 = category of bivalve shells; 2 = category of inorganic materials; 3 = category of sandy sediments. Homogenous groups are marked with similar letter (Table 2 for details). Different larval densities ( $N$ ) were used between the categories 1–2 and category 3 (see Section 2.1.3) and no statistical comparisons were done between categories

**FIGURE 6** Effect of bivalve shell orientation (upper-surface and bottom-side) on larval settlement of *O. edulis* in experiment 1 (hatchery). Letters indicate significant differences between upper-surface and bottom side for each shell species

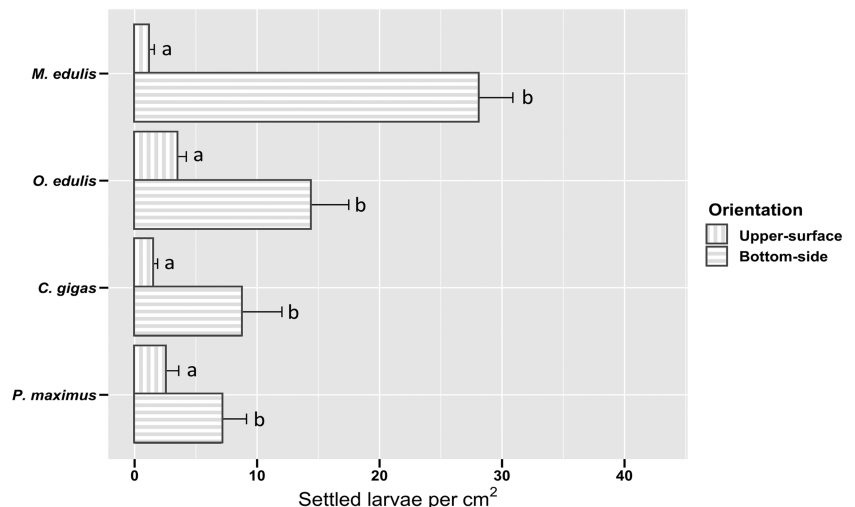

#### 4.1 | Settlement preferences of hatched *Ostrea edulis* pediveligers

High larval concentrations were chosen for the hatchery experiments based on their relevance for commercial aquaculture production. This was designed to compensate for the potential loss of larvae owing to the high mortality of early life stages in hatchery production, but it also facilitated the identification of settlement preferences in controlled environments.

Key finding 1: *M. edulis* and *O. edulis* shells are the most preferred substrate types to produce *O. edulis* seed oysters in hatcheries.

In this study, a direct comparison of the larval settlement response to different shell substrates of species harvested in large volumes (hundreds of tonnes per year worldwide) was evaluated in a hatchery setting. Interestingly, settlement on *M. edulis* shells, and to a lesser extent on *O. edulis* shells, was significantly higher than on other shells. Recent laboratory experiments indicate a high settlement preference of *O. edulis* larvae on shells of life conspecifics in comparison with *C. gigas* shells (Rodriguez-Perez et al., 2019), which is consistent with the results here. However, further investigations on the settlement preference of *O. edulis* larvae between different substrates in the presence of live individuals should be carried out in order to dissociate substrate preferences and settlement cues. As an example, habitat-associated underwater sounds are a cue for *Crassostrea*

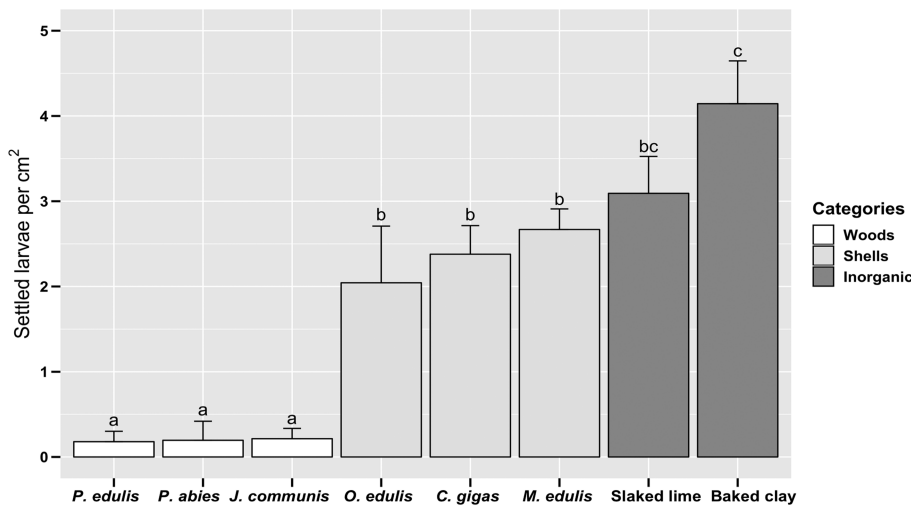

**FIGURE 7** Results of field experiment on settlement preferences of *O. edulis* larvae on different substrate categories and types (orientations combined): wood materials (white), bivalve shells (light grey) and inorganic substrates (dark grey). All results presented exclude the limed substrate category; the comparison between hydrated lime and limed shells is provided in Figure S1. Homogenous groups are marked with the same letters

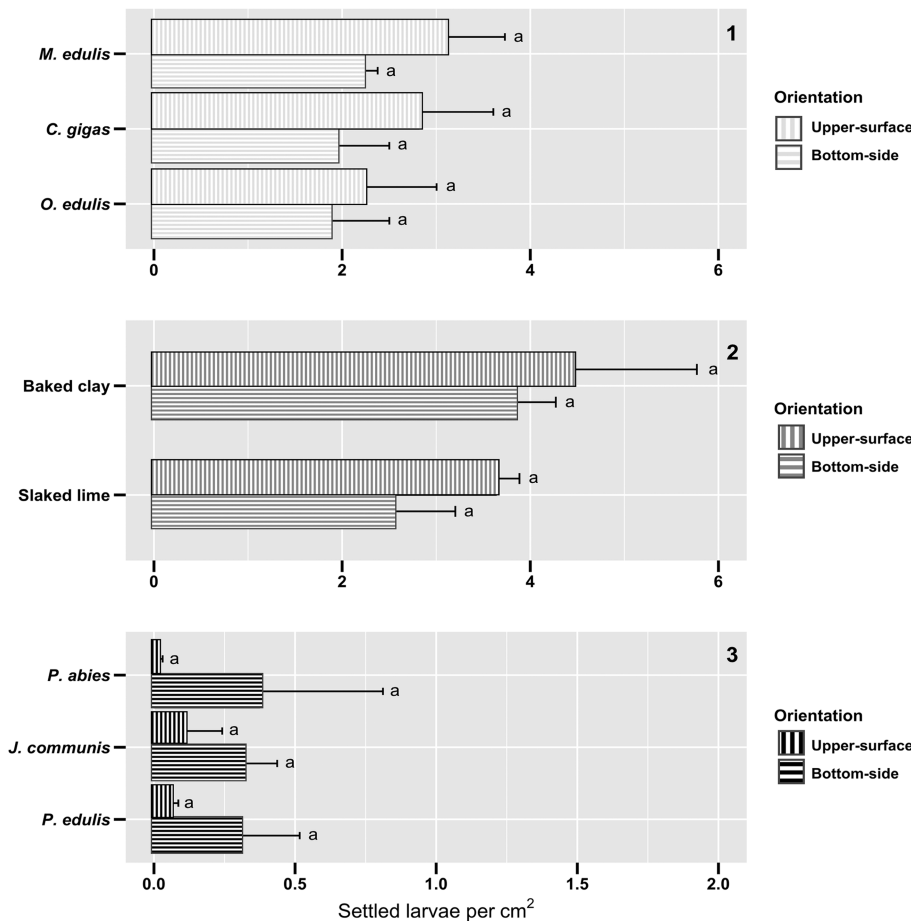

**FIGURE 8** Effect of substrate orientation (upper-surface and bottom-side; irrespective of inner or outer surface of the valves) on the settlement of *O. edulis* larvae in the field: 1 = category of bivalve shells; 2 = category of inorganic materials; 3 = substrate category of wood materials. Homogenous groups are marked with the same letters

*virginica* (Lillis, Eggleston, & Bohnenstiehl, 2013). The significant attraction of *O. edulis* larvae to *M. edulis* shells may be related to shell colour and composition. According to Cole and Knight Jones (1949), the eventual blackening of oyster shells influences the settlement rate of *O. edulis* larvae and dark faces of the substrates seem to increase the settlement rate (Walne, 1974), possibly related to negative

phototropism of the late larval stages at the time of settlement (Bracke & Polk, 1969), which merits further investigation. No direct comparison is possible between c-shells and c-inorganics in experiment 1 owing to the isolation of categories within the experimental design. However, we can conclude that the shell of recently bleached *M. edulis* is a very attractive substrate for the hatchery production of

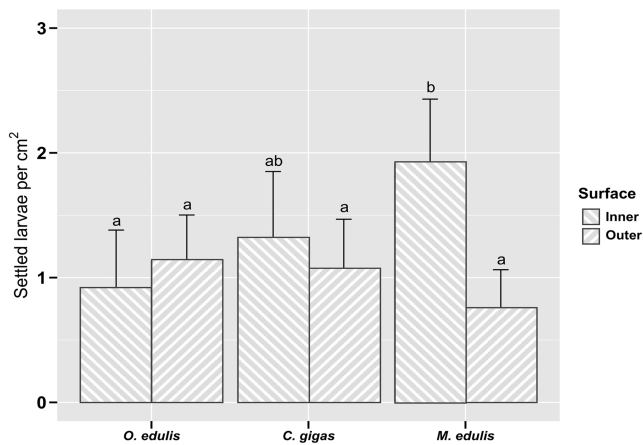

**FIGURE 9** Settlement preferences of *O. edulis* larvae in the field between inner and outer shell surface (irrespective of upper-surface and bottom-side orientation). Inner surface of the shells here corresponds to their concave surface. Homogenous groups are marked with the same letters

spat-on-shell. The greater attractiveness of a substrate limits the loss of larvae by their settlement on tank walls or mortality during the search for an appropriate substrate.

**Key finding 2:** Lime and clay are ideal inorganic materials to use for *O. edulis* seed production in hatcheries. EMA was not identified as successful.

The significant preference for slaked lime and baked clay over EMA and granite is possibly related to its respective composition and/or surface texture, as the colours of all of these substrate types were similar: bright and whitish. The compositions of slaked lime, baked clay and granite are known (Figure S1 and Table S1); no analysis was performed for EMA. Slaked lime is calcium based and may resemble the composition of oyster shells. The clay has high silicate as well as high calcium and magnesium contents, again, similar to oyster shells (Medaković, Traverso, Bottino, & Popović, 2006; Yonge, 1960). Granite is made from quartz and feldspar and has a much coarser structure than clay and lime. In summary, clay and lime, whose composition is close to that of oyster shells, are adequate as components of nature-based reef structures used in hatchery production of oyster spat for ecological restoration.

**Key finding 3:** *O. edulis* larvae settle on shell fragments of sandy sediments.

No settlement preference was observed among the different size classes of the tested sediment types. The aim was to determine whether an increased settlement of *O. edulis* larvae could be expected on sediment, as a function of a grain size gradient. However, we did observe that larvae were fixed on the small shell pieces rather than the stone grains (Figure S2). These findings confirm the poor settlement rate of *O. edulis* larvae on granite and, furthermore, that high

proportions of shell detritus in soft sediments may contribute to high substrate suitability for European flat oyster restoration in the field.

**Key finding 4:** Innovative 3D-sandstone reef structures show high settlement response of *O. edulis* larvae.

Three-dimensional-sandstone reefs (3D-ReefVival-Experimental-Reefs<sup>®</sup>) were produced specifically for the ecological restoration of *O. edulis* in the North Sea sublittoral. Producing spat on artificial reefs in a hatchery for recruitment-limited and substrate-limited areas is a promising approach to introduce certified disease-free young oysters on structures that are massive enough to potentially withstand the prevailing sediment dynamics. The settlement response on 3D-sandstone reefs was investigated for the first time and clearly showed successful results: settlement rates of *O. edulis* larvae on examined areas were confirmed while no settlement was observed on the tank walls, which indicates that larvae clearly preferred the substrate provided by the sandstone reefs. Living reefs were kept in tanks and will be used for further field studies. The counting of settled larvae was limited to accessible areas for visual inspection. In a next step, the applicability of 3D-sandstone reefs for *O. edulis* statement needs to be tested in the field.

## 4.2 | Settlement preferences of *Ostrea edulis* larvae in the field

**Key finding 5:** Clay, lime and bivalve shells are suitable substrate types to enhance recruitment in the field. Limed materials are attractive for larvae regardless of which shell material is coated.

**Key finding 6:** No significant differences in settlement preference were observed within the categories of bivalve shells or inorganic materials in the environment.

This finding clearly differs from results obtained in controlled conditions and confirms the importance of natural biofilms (Korringa, 1940; Rodriguez-Perez et al., 2019). It is possible that the formation of biofilms on the substrates in the field would successfully mask the differences in the original settlement response of the respective substrate types. Smyth et al. (2018) also found no difference in settlement rates on different shell types tested in field conditions. We assumed that marine biofilm development on these substrates may override the differences in *O. edulis* larvae settlement observed in the hatchery experiment and may play a major role in settlement response.

**Key finding 7:** *Ostrea edulis* larvae do not settle successfully on the tested wood materials.

Friele (1899) and Korringa (1976) described dried branches of common juniper as very good collectors for *O. edulis* larvae in breeding polls (Norway, Colsoul et al., submitted). In this study, cut and

dried *J. communis* wood was used, which showed only a poor settlement response. This is assumed to be unrelated to the flat surface of the wooden substrates, as it is similar to inorganic substrates that showed the highest settlement rates. However, the structure of the surface may delay the development of a biofilm owing to the less pronounced roughness. Coating the wood materials with slaked lime failed, as it did not adhere to these materials: the smooth surfaces of *P. edulis* and *P. abies* are not suitable for retaining slaked lime.

#### 4.3 | Orientation and surface

Following up on different settlement responses of upper-surface and of bottom-side shell areas obtained in the hatchery, both orientations were investigated in the field, including the potential effects of inner and outer shell surfaces.

**Key finding 8:** Differences in settlement preference regarding substrate orientation were significant in hatchery experiments, but not in the field.

In experiments 1 and 2, the majority of the larvae settled on the bottom-oriented surfaces of bivalve shells and of the 3D-sandstone reefs. Cole and Knight Jones (1939, 1949) also observed a significant number of settled larvae on bottom-oriented surfaces, which can be connected to the shadow that the bottom-sides provide and the negative phototropism identified for oyster larvae in their late stages by Bracke and Polk (1969) and Walne (1974). The larvae of *O. edulis* are active swimmers until their final settlement and move through the water column, driven by food availability and ideal stream layers for dispersal and settlement (Cranfield, 1973; Waller, 1981). In experiment 2 (Table 1) settlement occurred not only near the bottom, but over the entire reef height and with significantly greater settlement preference for the bottom-oriented areas in each layer. In contrast, no significant differences were observed between upper-surface and bottom-side surfaces in the field (experiment 3), where Korrington (1940) observed higher numbers of settled *O. edulis* larvae on upper- than bottom-side substrate surfaces. This could be related to potential effects of turbulent hydrodynamic conditions, in particular under laboratory conditions (down-welling systems) and should be included in future studies, especially in high-energy environments of designated oyster restoration sites in the open North Sea.

**Key finding 9:** Effects of inner and outer surface only apply for *M. edulis*.

*Ostrea edulis* larvae showed no significant settlement preferences for inner or outer shell surfaces of substrates, except for the concave surface of *M. edulis*. The preference for the inner shell surface of *M. edulis* may further indicate the influence of the surrounding hydrodynamics, as other tested shell types did not have the same hump shape.

#### 4.4 | Implications and applications

Considering the requirements for ecological restoration of the European flat oyster, this study provides suggestions for the selection of sustainable, environmentally friendly and nature-based substrates, both for hatchery production and for implementation in the field. Existing studies have so far not addressed the direct comparison of similar substrates, nature, texture, composition, orientation and shape under hatchery and field conditions. Different settlement preferences of *O. edulis* larvae assessed in this study, in both hatchery experiments and in the field, provide some explanations for the contrasting results from the literature, which indicate that substrate factors influencing larval behaviour are still not well understood (Cole & Knight Jones, 1949; Korrington, 1940; Rodriguez-Perez et al., 2019; Smyth et al., 2018; Walne, 1974).

A clear and extremely relevant outcome of this study is the scientific confirmation that natural and native substrate types (*M. edulis* shells, *O. edulis* shells) as well as commonly used nature-based (lime) and innovative nature-based (clay, 3D printed sandstone) materials are useful for the ecological restoration of *O. edulis*. Accordingly, the implementation of artificial (e.g. concrete, plastics) substrate types can be avoided. This will minimize potential negative side-effects of active restoration measures and decrease biosecurity risks at the same time, as the introduction or translocation of non-native shell material (if not sterilized) may bring hitch-hiking, invasive species or diseases (Jeffs, 1999).

The high settlement response in *M. edulis* found in hatchery experiments is a key finding for hatchery production of seed oysters. Accordingly, hatchery production of single seeds could consider a similar composition of micro-cultch to increase larval settlement. *M. edulis* shells and *O. edulis* shells are appropriate substrates for the production of spat-on-shell in Europe. Furthermore, the high settlement response of bottom-side surfaces can be relevant for the production of spat-on-shell and spat-on-reef. For ecological restoration of *O. edulis*, it may be relevant that *M. edulis* shell disintegrates relatively quickly – less quickly than the slaked lime but faster than the shells of *O. edulis* and *C. gigas* (Korrington, 1976). Slaked lime also showed a high settlement response and can be applied to many substrates to increase larval settlement in hatcheries. However, high concentrations of slaked lime in recirculation systems can increase pH values, which may cause malformations of the larvae (Carbonnier et al., 1990). Baked clay also showed a high settlement response. As it can be produced in any 3D structure, its application as a reef structure, to be seeded with young oysters in the hatchery, is a relevant approach for future implementation of nature-based oyster reefs in the field.

As baked clay was proven to be the most attractive substrate in the field, a Europe-wide monitoring system of settlement rates could be established with clay plates. The need for common monitoring protocols to assess the success and ecological effects of oyster restoration is formulated in recommendation 5 of the Berlin Oyster Recommendation (Pogoda et al., 2019; Pogoda, Boudry, et al., 2020). Slaked lime and *M. edulis*, *O. edulis* and *C. gigas* shells all showed similar good settlement responses and are appropriate substrate types for









enhancing recruitment in the field. With reference to the results of this study, substrates of wooden materials are not recommended for ecological restoration.

In conclusion, these results provide a comprehensive list and a scientifically established comparison of suitable substrates. The use of sustainable, environmentally friendly and nature-based substrates for the ecological restoration of *O. edulis*, which are presented here, is key to future developments in hatcheries and for restoration practitioners in the field. The identified substrates will on the one hand increase a sustainable and successful hatchery production of spat-on-shell and of three-dimensional reef structures for recruitment-limited areas, and on the other hand enhance the recruitment of spat in substrate-limited areas.

## ACKNOWLEDGEMENTS

We thank the German Federal Agency for Nature Conservation for funding and supporting this project in close cooperation. We thank the Invertebrate Physiology Laboratory of Ifremer (France), the Centre for Aquaculture Research of AWI (Germany), Novostrea Bretagne SAS (France), Ferme Marine de l'île d'Arun EARL (France), Roland Krone/Reefauna (Germany), Boskalis Nederland BV (Netherlands) and Reef Design Lab (Australia) for their support. We thank the captain and crew of FS *Heincke* for supporting the sampling and especially the following colleagues for their help throughout the supervision of this study, the experimentation, the analysis and the writing stages: Karen Wiltshire, Henning von Nordheim, Thomas Rouault, Massoud Qayomi, Laurie Hofmann, Nick Mackay-Roberts, Kerstin von Twistern and Henrike Hohnholz. We would also like to thank all those who have helped in any way by providing bibliographic material, comments, suggestions and corrections. 2016–2019 RESTORE Project: Funded by the German Federal Agency for Nature Conservation, grant number FKZ 3516892001. Open access funding enabled and organized by Projekt DEAL.

## ORCID

Bérenger Colsoul  <https://orcid.org/0000-0002-7891-8036>  
 Stéphane Pouvreau  <https://orcid.org/0000-0003-2402-7366>  
 Carole Di Poi  <https://orcid.org/0000-0001-7846-5287>  
 Simon Pouil  <https://orcid.org/0000-0003-1531-0362>  
 Verena Merk  <https://orcid.org/0000-0002-9034-3431>  
 Corina Peter  <https://orcid.org/0000-0003-1342-2686>  
 Maarten Boersma  <https://orcid.org/0000-0003-1010-026X>  
 Bernadette Pogoda  <https://orcid.org/0000-0003-3997-426X>

## REFERENCES

- Abbe, G. R. (1988). Population structure of the American oyster, *Crassostrea virginica*, on an oyster bar in central Chesapeake Bay: Changes associated with shell planting and increased recruitment. *Journal of Shellfish Research*, 7, 33–40.
- Bates, D., Mächler, M., Bolker, B., & Walker, S. (2015). Fitting linear mixed-effects models using lme4. *Journal of Statistical Software*, 67, 1–48. <https://doi.org/10.18637/jss.v067.i01>
- Bayne, B. L. (1969). The gregarious behaviour of the larvae of *Ostrea edulis* L. at settlement. *Journal of the Marine Biological Association of the United Kingdom*, 49, 327–356. <https://doi.org/10.1017/S0025315400035943>
- Bayne, B. L. (2017). *Biology of oysters* (Vol. 41). Developments in Aquaculture and Fisheries Science. London: Elsevier Science/Academic Press.
- Benovic, A. (1997). The history, present condition, and future of the molluscan fisheries of Croatia. In C. L. MacKenzie, V. G. Burrell, A. Rosenfield, & W. L. Hobart (Eds.), *The history, present condition, and future of the molluscan fisheries of north and Central America and Europe* (Vol. 3, pp. 217–226). Seattle, WA: Scientific Publications Office, NMFS, NOAA.
- Bracke, E., & Polk, P. (1969). Contribution à la connaissance de la faune marine de la côte belge. [Contribution to the knowledge of the marine fauna of the Belgian coast.]. *Hydrobiologia*, 34, 100–125. <https://doi.org/10.1007/bf00040327>
- Carbonnier, N., Martin, A. G., Mazurie, J., Barthelemy, G., Le Mouroux, G., Martin, A. G., ... Miners, P. (1990). Télécaptage de l'huître plate: travaux réalisés en 1990. [Remote setting of the flat oyster: work carried out in 1990]. In *Section Régionale de Bretagne Sud: Plan de Relance de l'Huître Plate 1990* (pp. 1–97). Auray, France: CIC-IFREMER.
- Coatanea, D., Oheix, J., Mazzara, L., & Hamon, P. Y. (1992). Essais de télécaptage de l'huître plate *Ostrea edulis* en Méditerranée: Bilan 1991. [Remote setting trials of the flat oyster *Ostrea edulis* in the Mediterranean: Review 1991.] In *IFREMER Report: RIDRV-92.021 RA* (pp. 1–63). Palavas-les-Flots, France: French Research Institute for Exploitation of the Sea.
- Cole, H. A., & Knight Jones, E. W. (1939). Some observations and experiments on the setting behaviour of larvae of *Ostrea edulis*. *ICES Journal of Marine Science*, 14, 86–105. <https://doi.org/10.1093/icesjms/14.1.86>
- Cole, H. A., & Knight Jones, E. W. (1949). The setting behaviour of larvae of the European flat oyster *Ostrea edulis* L., and its influence on methods of cultivation and spat collection. In *Fishery investigations Series II* (Vol. 17, pp. 1–39). London: Her Majesty's Stationery Office.
- Colsoul, B., Boudry, P., Pérez-Parallé, M. L., Bratoš Cetinić, A., Hugh-Jones, T., Arzul, I., ... Pogoda, B. (submitted). Sustainable large-scale production of European flat oyster (*Ostrea edulis*) seed for ecological restoration and aquaculture: A review. *Reviews in Aquaculture*.
- Coste, J. M. C. V. (1861). *Voyage d'Exploration sur le Littoral de la France et de l'Italie*. Paris: Imprimerie Impériale.
- Cranfield, H. J. (1973). Observations on the behaviour of the pediveliger of *Ostrea edulis* during attachment and cementing. *Marine Biology*, 22, 203–209. <https://doi.org/10.1007/bf00389174>
- Davis, H. C., & Calabrese, A. (1969). Survival and growth of larvae of the European oyster (*Ostrea edulis* L.) at different temperatures. *The Biological Bulletin*, 136, 193–199. <https://doi.org/10.2307/1539813>
- Fitzsimons, J. A., Branigan, S., Gillies, C. L., Brumbaugh, R. D., Cheng, J., DeAngelis, B. M., ... Ermgassen, P. S. E. (2020). Restoring shellfish reefs: Global guidelines for practitioners and scientists. *Conservation Science and Practice*, 2, e198. <https://doi.org/10.1111/csp2.198>
- Friele, H. (1899). The oyster ponds on the west coast of Norway. In J. Brunchorst (Ed.), *Proceedings of the international congress of fisheries, Bergen* (pp. 188–200). Bergen, Norway: John Griegs Boktrykkeri AS.
- Gaarder, T., & Bjerkan, P. (1934). *Østers og Østerskultur i Norge*. Bergen, Norway: A.S John Griegs Boktrykkeri.
- Goreau, T. J. (2012). Marine electrolysis for building materials and environmental restoration. In V. Linkov & J. Kleperis (Eds.), *Electrolysis* (pp. 273–290). Rijeka, Croatia: InTech.
- Goreau, T. J., & Trench, R. K. (2012). *Innovative methods of marine ecosystem restoration*. Boca Raton, FL: CRC Press.
- Guesdon, K., Le Bec, C., Mazurie, J., & Lassale, E. (1989). Essais de télécaptage: huître plate. [Remote setting trials: flat oyster.]. In *Section Régionale de Bretagne Sud: Plan de Relance de l'Huître Plate 1989* (pp. 1–87). Auray, France: CIC-IFREMER.
- Helm, M. M., & Spencer, B. E. (1972). The importance of the rate of aeration in hatchery cultures of the larvae of *Ostrea edulis* L. *ICES Journal of Marine Science*, 34, 244–255. <https://doi.org/10.1093/icesjms/34.2.244>



- Herman, A. (1937). Reproduction of indigenous oysters in Morbihan and Finistère (Brittany) in 1936. *Revue des Travaux de l'Institut des Pêches Maritimes*, 10, 61–66.
- Hidu, H., Chapman, S., & Soule, P. W. (1975). Cultchless setting of European oysters, *Ostrea edulis*, using polished marble. *Proceedings of the National Shellfisheries Association*, 65, 13–14.
- Jeffs, A. G. (1999). The potential for developing controlled breeding in the Chilean oyster. *Aquaculture International*, 7, 189–199. <https://doi.org/10.1023/a:1009276329463>
- Kamermans, P., Walles, B., Kraan, M., van Duren, L., Kleissen, F., van der Have, T., ... Poelman, M. (2018). Offshore wind farms as potential locations for flat oyster (*Ostrea edulis*) restoration in the Dutch North Sea. *Sustainability*, 10, 1–24. <https://doi.org/10.3390/su10113942>
- Kerckhof, F., Coolen, J. W. P., Rumes, B., & Degraer, S. (2018). Recent findings of wild European flat oysters *Ostrea edulis* (Linnaeus, 1758) in Belgian and Dutch offshore waters: New perspectives for offshore oyster reef restoration in the southern North Sea. *Belgian Journal of Zoology*, 148, 13–24. <https://doi.org/10.26496/bjz.2018.16>
- Korringa, P. (1940). Experiments and observations on swarming, pelagic life and setting in the European flat oyster, *Ostrea edulis* L. PhD/Dr Thesis. University of Amsterdam, Netherlands.
- Korringa, P. (1946a). The decline of natural oyster beds. *Basteria*, 10, 36–41.
- Korringa, P. (1946b). A revival of natural oyster beds? *Nature*, 158, 586–587. <https://doi.org/10.1038/158586d0>
- Korringa, P. (1976). *Farming the flat oysters of the genus Ostrea. Developments in aquaculture and fisheries science*. Amsterdam: Elsevier Scientific.
- Lenth, R., Buerkner, P., Herve, M., Love, J., Riebl, H., & Singmann, H. (2018). Emmeans: Estimated marginal means. Aka Least-squares Means, (R) v.1.5.0.
- Lillis, A., Eggleston, D. B., & Bohnenstiehl, D. R. (2013). Oyster larvae settle in response to habitat-associated underwater sounds. *PLoS ONE*, 8, e79337. <https://doi.org/10.1371/journal.pone.0079337>
- Locard, A. (1900). *Manuel pratique d'ostréiculture*. Paris: JB Baillière & Fils.
- Lüdecke, D. (2018). ggffects: Tidy data frames of marginal effects from regression models. *Journal of Open Source Software*, 3, 772–1–772–5. <https://doi.org/10.21105/joss.00772>
- MacKenzie, C. L. (1970). Causes of oyster spat mortality, conditions of oyster setting beds, and recommendations for oyster bed management. *Proceedings of the National Shellfisheries Association*, 60, 59–67.
- Marteil, L. (1976). Shellfish culture in France. Part 2. Oyster and mussel biology. *Revue des Travaux de l'Institut des Pêches Maritimes*, 40, 149–346.
- Medaković, D., Traverso, P., Bottino, C., & Popović, S. (2006). Shell layers of *Ostrea edulis* as an environmental indicator of TBT pollution: The contribution of surface techniques. *Surface and Interface Analysis*, 38, 313–316. <https://doi.org/10.1002/sia.2183>
- Naas, K. E. (1991). A semi-intensive method for spat production of the European flat oyster (*Ostrea edulis* L.). *Aquacultural Engineering*, 9, 447–451. [https://doi.org/10.1016/0144-8609\(90\)90032-U](https://doi.org/10.1016/0144-8609(90)90032-U)
- Pogoda, B. (2019). Current status of European oyster decline and restoration in Germany. *Humanities*, 8, 9–1–9–12. <https://doi.org/10.3390/h8010009>
- Pogoda, B., Boudry, P., Bromley, C., Cameron, T. C., Colsoul, B., Donnan, D., ... Sas, H. (2020). NORA moving forward: Developing an oyster restoration network in Europe to support the Berlin oyster recommendation. *Aquatic Conservation: Marine and Freshwater Ecosystems*, 30, 2031–2037. <https://doi.org/10.1002/aqc.3447>
- Pogoda, B., Brown, J., Hancock, B., Preston, J., Pouvreau, S., Kamermans, P., ... von Nordheim, H. (2019). The Native Oyster Restoration Alliance (NORA) and the Berlin Oyster Recommendation: Bringing back a key ecosystem engineer by developing and supporting best practice in Europe. *Aquatic Living Resources*, 32, 13–1–13–9. <https://doi.org/10.1051/alr/2019012>
- Pogoda, B., Merk, V., Colsoul, B., Hausen, T., Peter, C., Pesch, R., ... zu Ermgassen, P. (2020). Site selection for biogenic reef restoration in offshore environments: The Natura 2000 site Borkum Reefground as a case study for native oyster restoration. *Aquatic Conservation: Marine and Freshwater Ecosystems*, 30, 2163–2179. <https://doi.org/10.1002/aqc.3405>
- Poirier, L. A., Clements, J. C., Davidson, J. D. P., Miron, G., Davidson, J., & Comeau, L. A. (2019). Sink before you settle: Settlement behaviour of Eastern oyster (*Crassostrea virginica*) larvae on artificial spat collectors and natural substrate. *Aquaculture Reports*, 13, 100181–1–100181–16. <https://doi.org/10.1016/j.aqrep.2019.100181>
- Pouvreau, S. (2015). Observer, analyser et gérer la variabilité de la reproduction et du recrutement de l'huître creuse en France: Le réseau Velyger. Rapport annuel 2014 [Observe, analyze and manage the variability of reproduction and recruitment of Pacific oysters in France: The Velyger network. Annual report 2014]. In IFREMER report: RBE/PFOM/PI 2015–1 (pp. 1–58). France: French Research Institute for Exploitation of the Sea.
- Pouvreau, S., Cochet, H., Gachelin, S., Chaudemanche, S., & Fabien, A. (2019). Flat oyster conservation program in France: Ecology, inventory and recovery of the last native oysters beds in Brittany (the FOREVER project). In IFREMER report: RBE/PFOM/PI 2019–3 (pp. 1–59). France: French Research Institute for Exploitation of the Sea.
- R-Development-Core-Team. (2018). *R: A language and environment for statistical computing*. Vienna: R Foundation for Statistical Computing.
- Robert, R., Vignier, J., & Petton, B. (2017). Influence of feeding regime and temperature on development and settlement of oyster *Ostrea edulis* (Linnaeus, 1758) larvae. *Aquaculture Research*, 48, 1–18. <https://doi.org/10.1111/are.13297>
- Rodriguez-Perez, A., James, M., Donnan, D. W., Henry, T. B., Møller, L. F., & Sanderson, W. G. (2019). Conservation and restoration of a keystone species: Understanding the settlement preferences of the European oyster (*Ostrea edulis*). *Marine Pollution Bulletin*, 138, 312–321. <https://doi.org/10.1016/j.marpolbul.2018.11.032>
- Sawusdee, A., Jensen, A. C., Collins, K. J., & Hauton, C. (2015). Improvements in the physiological performance of European flat oysters *Ostrea edulis* (Linnaeus, 1758) cultured on elevated reef structures: Implications for oyster restoration. *Aquaculture*, 444, 41–48. <https://doi.org/10.1016/j.aquaculture.2015.03.022>
- Smyth, D., Mahon, A. M., Roberts, D., & Kregting, L. (2018). Settlement of *Ostrea edulis* is determined by the availability of hard substrata rather than by its nature: Implications for stock recovery and restoration of the European oyster. *Aquatic Conservation: Marine and Freshwater Ecosystems*, 28, 1–10. <https://doi.org/10.1002/aqc.2876>
- Taylor, A. C. F. (2011). Electro mineral accretion. In D. Hopley (Ed.), *Encyclopedia of Modern Coral Reefs: Structure, Form and Process* (pp. 368–368). Springer Netherlands: Dordrecht.
- Thurstan, R. H., Hawkins, J. P., Raby, L., & Roberts, C. M. (2013). Oyster (*Ostrea edulis*) extirpation and ecosystem transformation in the Firth of Forth, Scotland. *Journal for Nature Conservation*, 21, 253–261. <https://doi.org/10.1016/j.jnc.2013.01.004>
- van Treeck, P., & Schuhmacher, H. (1997). Initial survival of coral nubbins transplanted by a new coral transplantation technology-options for reef rehabilitation. *Marine Ecology Progress Series*, 150, 287–292. <https://doi.org/10.3354/meps150287>
- Vogel, G. (2017). Where have all the insects gone? *Science*, 356, 576–579. <https://doi.org/10.1126/science.356.6338.576>
- Voultsiadou, E., Koutsoubas, D., & Achparaki, M. (2010). Bivalve mollusc exploitation in Mediterranean coastal communities: An historical approach. *Journal of Biological Research-Thessaloniki*, 13, 35–45.
- Waller, T. R. (1981). Functional morphology and development of veliger larvae of the European oyster, *Ostrea edulis* Linné. In T. R. Waller (Ed.),

- Smithsonian Contribution to Zoology* 328 (pp. 1–80). Washington, DC: Smithsonian Institution Press.
- Walne, P. R. (1958). The importance of bacteria in laboratory experiments on rearing the larvae of *Ostrea edulis* (L.). *Journal of the Marine Biological Association of the United Kingdom*, 37, 415–425. <https://doi.org/10.1017/S002531540002378X>
- Walne, P. R. (1974). *Culture of bivalve molluscs: 50 years experience at Conwy*. Surrey: Fishing News Books Limited.
- Westby, S., Geselbracht, L., & Pogoda, B. (2019). Shellfish reef restoration in practice. In L. Fitzsimons, S. Branigan, R. D. Brumbaugh, T. McDonald, & P. S. E. zu Ermgassen (Eds.), *Restoration guidelines for shellfish reefs* (pp. 36–48). Arlington, VA: The Nature Conservancy.
- Yonge, C. M. (1960). *Oysters. The new naturalist*. London: Collins.

## SUPPORTING INFORMATION

Additional supporting information may be found online in the Supporting Information section at the end of this article.

**How to cite this article:** Colsooul B, Pouvreau S, Di Poi C, et al. Addressing critical limitations of oyster (*Ostrea edulis*) restoration: Identification of nature-based substrates for hatchery production and recruitment in the field. *Aquatic Conserv: Mar Freshw Ecosyst*. 2020;30:2101–2115. <https://doi.org/10.1002/aqc.3454>





# Chapter III

## KEY FINDINGS

- ❖ Development of a treatment method for bivalve shells, for applications in small, medium and large-scale restoration projects.
- ❖ Development of a method for the import, sorting and sterilization of bivalves shells for restoration of *O. edulis*.
- ❖ Observation and identification of knowledge gaps and further research topics.
- ❖ Implementing new data into restoration practices and biosecurity guidelines.

# Chapter III

## SHELLS FROM MARICULTURE AND FISHERIES FOR OYSTER (*OSTREA EDULIS*) RESTORATION: OBSERVATIONS AND IMPLICATIONS

Bérenger Colsoul, Corina Peter, Maarten Boersma, Tanja Hausen, Simon Pouil, Verena Merk, Karen Wiltshire, Henning von Nordheim and Bernadette Pogoda

*In prep.* for submission

Figure and table numbers in this manuscript begin with (M)

# **Shells from mariculture and fisheries for oyster (*Ostrea edulis*) restoration: observations and implications**

Bérenger Colsoul, Corina Peter, Maarten Boersma, Tanja Hausen, Simon Pouil, Verena Merk, Karen Wiltshire, Henning von Nordheim and Bernadette Pogoda

## **Abstract**

Moving oyster shells in the context of restoration and mariculture to provide appropriate settlement substrate and enhance natural recruitment is a common practice. While it is common sense that the transfer of living oysters poses the risk of transferring associated, potentially invasive species, pests or pathogens, the role of shell transfers is not so clear. In this study, we describe the practice and paths of shell transfer for European flat oyster restoration (including shell usage for seed oyster production in hatcheries). We sorted and identified different species groups and tested different treatments to avoid such unwanted hitchhikers. The experimental treatments of fished shell material compared effects of freshwater, chlorine and brine baths, autoclaving, ozonation and nine months of weathering and resulted in: (1) Identification of the shell species from the sorting demonstrates the presence within the imported shells of: exotic and/or invasive species, predatory species of oysters, and sympatric associated species; (2) Treatments including freshwater, autoclaving, ozonation and chlorination appear to eradicate all macroscopic shell-related organisms.

## **Key words**

Aquaculture, Biosecurity, Ecology, European flat oyster, Marine habitat, Spat-on-shell

## Introduction

Marine ecosystems undergo severe changes due to numerous anthropogenic impacts (Duarte *et al.*, 2020). The loss of biogenic reef systems is a well-described consequence with critical ecological effects (e.g. Beck *et al.*, 2011). In order to counteract this trend, ecological restoration is considered as an appropriate tool for conservation management with the aim to contribute to the protection and/or improvement of natural ecosystems and important ecosystem goods and services (Gann *et al.*, 2019). Along different environments, also in marine ecosystems, the relevance of protecting or increasing biodiversity via ecological restoration measures has grown steadily over the last decades (Clewel & Aronson, 2013; Gann *et al.*, 2019). Worldwide, more than 85% of oyster reef habitats have been lost (e.g. Beck *et al.*, 2011). Following examples from the USA and Australia, restoration of degraded biogenic reefs has become a focus of ecological restoration in Europe. Today, restoration of the European flat oyster, *Ostrea edulis*, is in the centre of many actions and projects of marine conservation and protection (Pogoda *et al.*, 2019) with about twenty *O. edulis* restoration projects running in Europe to date (Pogoda *et al.*, 2020). Since the 17<sup>th</sup> century, oyster beds of the European flat oyster have been declining and, in some areas, like the German North Sea, *O. edulis* is considered as functionally extinct today (Gercken & Schmidt, 2014; Pogoda, 2019). Overexploitation of once large oyster stocks due to intensive fishing activities are considered as one of the main factors for the disappearance of the ecological important species (Bennema *et al.*, 2020). As oyster fisheries extracted vast amounts of oysters, hence biogenic structures, today, the North Sea floor is considered as a substrate-limited area (absence of oyster shell material for a successful recolonization by *O. edulis* larvae today) as well as a recruitment-limited area (absence of broodstock producing larvae).

In the context of European flat oyster restoration, key prerequisites are the availability of suitable substrate and the availability of suitable seed oysters (Pogoda *et al.* 2019). Both aspects are connected to shell material, either for the deployment of shell material in substrate-limited areas to provide and enhance sufficient settlement surfaces for oyster spat recruitment, or for the production of spat-on-shell produced in hatcheries for which shell material is the settlement base during production. Moreover, both aspects are a key focus and major challenge for all restoration projects in Europe (Colsoul *et al.*, 2020; zu Ermgassen *et al.*, 2020a; Potet *et al.*, 2021).

Traditionally, bivalve shells are used for spat collection for aquaculture purposes. They are placed into the water in the time window of larval swarming (Cole & Knight Jones, 1939; Colsoul *et al.*, 2021). In restoration measures, bivalve shells are also the preferred substrate due to the biological adequateness for oyster settlement, recruitment, and sustainability (Branigan *et al.*, 2020; Diggles, 2021). Bivalve, and in the case of *O. edulis* restoration measures, especially European flat oyster shells are collected in different ways: collection from restaurants, collection from fisheries and/or dredging of buried shells (Jovic *et al.*, 2019; Morris *et al.*, 2019; Anonymous, 2020; Hanke *et al.*, 2021). Studies on the latter however showed significantly lower larval settlement of eastern oyster (*Crassostrea virginica*) larvae on previously buried, relic shells from anoxic sediments than on sun-cured white shells (Hanke *et al.*, 2021). “Fresh” shells on the other side need to be carefully prepared prior to use, in order to prevent the translocation of associated organisms (Bushek *et al.*, 2004; Cohen &

Zabin, 2009) and minimize biosecurity risks (Branigan *et al.*, 2020; Diggles, 2021). Common treatment methods include desiccation of shells over long time periods (Bushek *et al.*, 2004; Brumbaugh & Coen, 2009), bathing in hot water (Diggles, 2021), bathing in freshwater or vinegar (Diggles, 2021) or the chemical treatment of shells using e.g. chlorine (zu Ermgassen *et al.*, 2020b). Most of these methods were tested and optimized by restoration efforts in USA and Australia, restoring and using shells of the once European flat oysters to these areas like *Crassostrea virginica*, *Saccostrea glomerata* and *Ostrea angasi* (Diggles, 2021, Brumbaugh *et al.* 2006). Pathogens, marine pests and associated organisms however are adapted to their specific ecosystem (temperature, etc.), therefore translocation risks connected to the transfer of *O. edulis* shells in Europe need to be examined in detail before transferring methodologies and results from studies conducted in other areas and with other species. Within Europe, where the collection of *O. edulis* shells is only possible in some areas due to the species' narrow expansion area today. Shells will be supplied from these areas to restoration areas, potentially in different water bodies, and an applicable cleaning protocol needs to be established before translocating the shells to avoid transferring harmful, non-native organisms along with them (Cohen & Zabin, 2009; zu Ermgassen *et al.*, 2020b).

In a first step of developing this protocol, this study aims to examine the survival of associated organisms on *O. edulis* shells after different cleaning treatments. Further, this study compares the experimental results to diseases and parasites known from literature, possibly being transported within European marine waters by oyster shell translocation.

## **Materials and Methods**

This study applied an experimental approach with different treatments to oyster shell material. Shell materials were collected from France and Germany. Two types of observations were carried out: (A) inventory of organisms found inside the big-bags in which shell material was transported and stored; (B) assessment of sterilisation methods of the shell material in order to establish and apply an optimal biosecurity for a re-use at sea.

### **Shell collection, import and storage**

European flat oyster shells from France were collected as shellfish waste from an oyster farm using deep-water cultivation techniques. The primary origin of the shells is the bay of Mont-Saint-Michel within the shellfish production area known as "du large" (code 35.01; 48°46.564'N 1°50.252'W). Dredging and sorting was carried out in September 2019 (import I) and in June 2020 (import III). During mechanised sorting operations of European flat oysters for marketing and human consumption, the shell/waste were separated and sorted into big-bags (size of 90x90x110 cm: 1m<sup>3</sup> capacity; no liner; 160 g/m<sup>2</sup> mesh size; Figure M1) on pallets. European flat oyster shells from Germany were collected during a research cruise at Helgoland (Tiefe-Rinne 54°8.6'N 7°53.4'E; Caspers, 1939) in the North Sea (Buck, 2019). Dredging and sorting was carried out in October 2019 (import II) with a grapple bucket. Contents (ca. 31 kg dry biomass) were stored in a non-watertight basin.

All shell material (from France and from Germany) was transported to AWI Bremerhaven within 48 hours. Big-bags were stored outside at AWI Bremerhaven for a period of five to nine months (import I), four months (import II) or only two weeks (import III) prior to experiments (see Table M1).

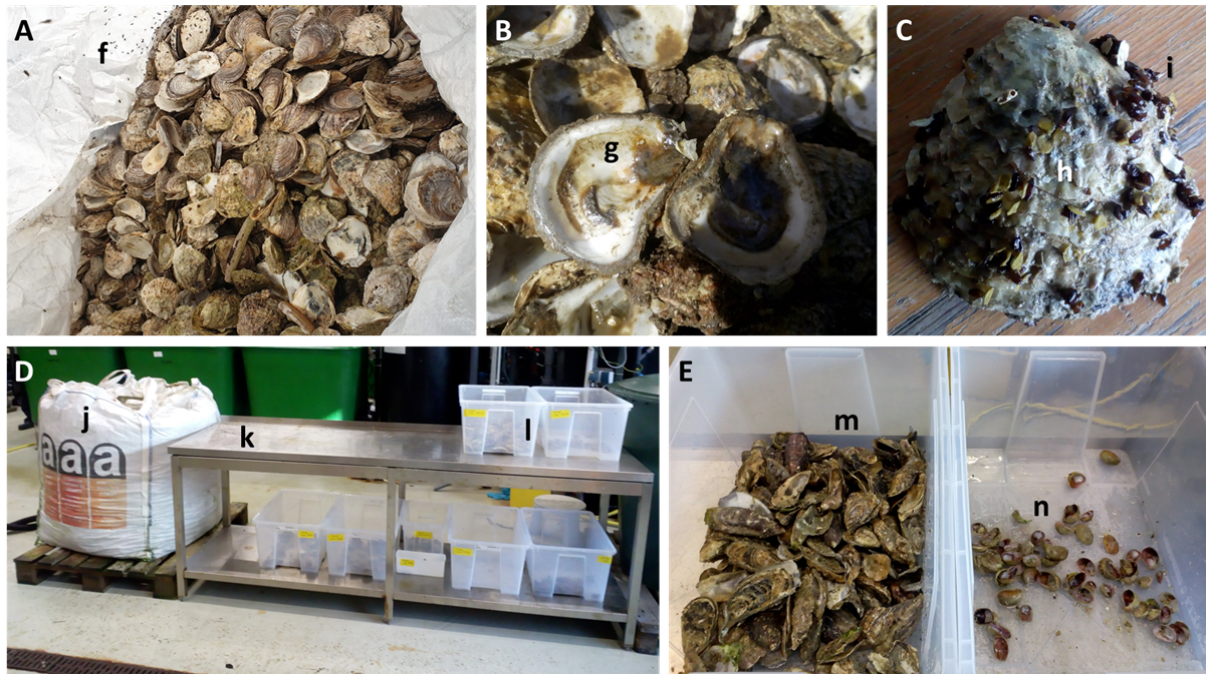

**Figure M1** Storage of shells in big-bags, sorting room and example of sorted shells. (A) Overhead view of a storage big-bag; (f) Diptera in adult and pupal stage. (B) View of the inside of a freshly opened *O. edulis* shell; (g) Remaining hydrated flesh. (C) *O. edulis* shell with medium fouling; (h) Attached gastropod eggs, (i) Diptera pupae. (D) Inner sorting bin; (j) Big-bag, (k) Sorting table, (l) Sorting boxes. (E) Two examples of shell categories; (m) *C. gigas* shells, (n) *C. fornicata* shells.

**Table M1** Origin of shells, storage duration and observation phases.

Import	Source	Dry biomass [kg]	Transport	Storage	Identification of hitchhikers	Treatment experiments
I	France	2000	48 hours	5 (sorting) & 9 (treatment) months	Yes	Yes
II	Germany	31	48 hours	4 months	Yes	No
III	France	369	48 hours	2 weeks	No	Yes

## **Shell sorting and identification of hitchhiking organisms (A)**

For the inventory of organisms found inside the shell material, subsamples of the shells/waste from import I (France) and import II (Germany) were sorted by hand to identify hitchhiking organisms and the amount of non-oyster shell material. All items were categorised, stored and weighed (by categories) at the end of the sorting process (Figure M1). Samples were taken from each category, including shells of different (mollusc) species and measured with a calliper. All items were photographed, before and after opening the valves of bivalves. Species identification was done by visual observation (Le Neuthiec, 2013; Gouilletquer, 2016) before discarding the subsamples.

## **Shell treatments and rewatering (B)**

For the assessment of sterilisation methods of the shell material, different shell sterilisation treatment experiments were conducted with randomly taken unsorted shells import I and III.

### *Shell treatments*

In order to determine the most effective method or to find out whether differences exist between their ways of eradicating living organisms from the shells, a total of six treatments was developed and tested for *O. edulis* (OS) shells (Table M2): 1) a 9-month weathering (OS-W); 2) a freshwater bath (OS-F); 3) a brine bath (OS-B); 4) autoclaving (OS-A); 5) ozonation (OS-O); 6) chlorination (OS-C). In addition, there were two positive controls: one comprising totally untreated shells (including other items) (U-OS), and a second one comprising a selection of only *O. edulis* shells (unscraped) (OS). The control category (U-OS) included all shells of different species but predominantly *O. edulis* (see section Shell sorting and identification) with associated epibiont and residues. All other categories (OS) comprised a selection of *O. edulis* shells, including associated epibionts, and some residues. Treatments (except OS-W) were carried out simultaneously so that the end of the treatments coincided with the beginning of the rewatering phase.

**Table M2** Description of six different shell treatments. Abbreviations: FW, fresh water; SW, seawater.

<b>Treatment</b>	<b>Treatment description</b>	<b>Amount of shells</b>	<b>Import (France)</b>
OS-W (1)	Weathering [9 months] Simple process of storing the shells in close big-bags outdoors for a period of nine months.	1000 kg	I



OS-F (2)	Freshwater bath [48 hours] <i>O. edulis</i> shells were immersed in 40l (tap) FW. Salinity was controlled around 5.1.	10 kg	III
OS-B (3)	Brine bath [48 hours] <i>O. edulis</i> shells were immersed in 40l (tap) FW + synthetic salt (Instant Ocean®). Salt was added until a salinity of 100 was reached.	10 kg	III
OS-A (4)	Autoclaving [15 minutes] <i>O. edulis</i> shells were autoclaved (Systec VX-150®) on a dry basis process. Autoclaving lasted for a period of fifteen minutes at 121°C. This treatment was considered as a negative control.	10 kg	III
OS-O (5)	Ozonation [6 hours] <i>O. edulis</i> shells were immersed in 40l SW (salinity of 35) filtered at 1µm to which an ozone inlet was added (bubbling). The ozone generator (S1000mg Sander®) produced a stable drop in redox level at 238.2 mv over six hours.	10 kg	III
OS-C (6)	Chlorination [1 hour] <i>O. edulis</i> shells were immersed in 40l SW (salinity of 35) filtered at 1µm with a concentration of 220 mg.l <sup>-1</sup> NaCl (11x 20g chlorine tablet; SwimCare® Steinbach), followed by a drying period (24 hours) prior to the rewatering phase.	10 kg	III

### Rewatering

Following the treatments, 24 glass aquaria with a total volume of 40l, including a bubbler for 0.2 µm filtered air, were mobilised in a temperature-controlled chamber at 20°C. The aquaria and air inlet tubes were washed, rinsed, dried, sprayed with 70% ethanol, and dried again before being placed in water. These aquaria were then half-filled (20l) with deionised water to which synthetic sea salt (see section Shell treatments) was added to a salinity of 35. Watering took place 24 hours before shell immersion so that the water temperature was constant at 20°C. The 24 aquaria correspond to the eight categories of shells to be immersed (six treatments and two controls) in triplicates (Figure M2). All aquaria were placed under neon lights with a photoperiod of 24:24. Following the immersion of 2.5 kg of shells of each category per aquarium, they were closed with a plastic film and left to incubate for fourteen days before the experiment was ended and final observations documented.

### Observation method

Following the rewatering phase, a visual observation was carried out for each aquarium. The observation took place in two steps: 1) an observation in the aquarium (movement of living organisms, development of epibionts); 2) an observation of six shells per aquarium taken randomly (if no epibionts were found) for visual inspection under a stereomicroscope (Zeiss™ Stemi™ DV4) with a magnification of x32.



**Figure M2** Experimental design and set up of the rewatering experiments. (A) Diagram of the 24 aquaria distributed on four shelves including triplicates (R1, R2, R3) corresponding to the controls (U-OS, OS) and pre-treatments (OS-W, OS-F, OS-B, OS-A, OS-O, OS-C) of the shells (see section Shell treatments and Table M2). (B) Example of a shelf with six aquaria at the start of the experiment (bubbling inactive).

## Results

### Shell identifications

### Helgoland-Tiefe-Rinne

The ca. 31 kg of shells were sorted into ten categories in order of prevalence of weight (Table M3): *O. edulis* shells, residue (sand, broken shells and stones), Pacific oyster shells (*Crassostrea gigas*), Variegated scallop shells (*Mimachlamys varia*), Waved whelk shells (*Buccinum undatum*), Northern horse-mussel shells (*Modiolus modiolus*), Common saddle oyster (*Anomia ephippium*), Hiatellidae (family of) shells, Slipper limpet shells (*Crepidula fornicata*), and Oval venus shells (*Timoclea ovata*). In the first three categories, shell lengths and widths were measured (mm): (*O. edulis*)  $82.61 \pm 8.62$ ,  $68.29 \pm 10.39$ ; (*C. gigas*)  $71.68 \pm 15.21$ ,  $49.18 \pm 12.45$ ; (*M. varia*)  $34.66 \pm 8.91$ ,  $29.76 \pm 8.25$ .

**Table M3** Details in weight and number of valves/shells of the different categories of the Helgoland-Tiefe-Rinne shell sorting. NA: not applicable.

Categories	Weight [g]	Number of valves/shells
<i>O. edulis</i>	27,860.00	864 valves
<i>C. gigas</i>	433.23	44 valves
<i>M. varia</i>	210.25	212 valves
<i>B. undatum</i>	86.63	2 shells
<i>M. modiolus</i>	54.36	3 valves
<i>A. ephippium</i>	34.42	45 valves
Hiatellidae (family of)	29.07	11 valves
<i>C. fornicata</i>	9.91	2 shells
<i>T. ovata</i>	4.33	32 valves
Residue	2,040.00	NA

These shells appear to be old shells and no living fouling organisms (e.g. tunicates, algae, sponges) were observed. Shells of *O. edulis* were perforated over large areas from boring sponges of the genus *Cliona* (Sander *et al.*, 2021). In addition, hollow tubes produced by tube worms were ubiquitous.

### Mont-Saint-Michel Bay

The ca. 375 kg sub-sample of shells were sorted into nineteen categories in order of prevalence of weight: *O. edulis* shells, *C. gigas* shells, *C. fornicata* shells, *M. varia* shells, *A. ephippium* shells, Atlantic scallop shells (*Pecten maximus*), European sting winkle shells (*Ocenebra erinaceus*) and Netted dog-whelk shells (*Tritia reticulata*), residue (sand, broken shells and stones), Solid surf clam shells (*Spisula solida*), Gibulla (genus of) shells, *B. undatum* shells, *Tellimya ferruginosa* shells, Common European bittersweet shells (*Glycymeris glycymeris*), Norwegian egg cockle shells (*Laevicardium crassum*), Warty venus

shells (*Venus verrucosa*), Blue mussel shells (*Mytilus edulis*), Chinese hat shells (*Calyptraea chinensis*), Arched razor shells (*Ensis magnus*), Common keyhole limpet (*Diodora graeca*). In the first four categories, shell lengths and widths were measured (mm): (*O. edulis*)  $70.18 \pm 7.23$ ,  $57.97 \pm 7.86$ ; (*C. gigas*)  $79.93 \pm 12.33$ ,  $43.05 \pm 7.37$ ; (*C. fornicata*)  $32.22 \pm 6.42$ ,  $21.71 \pm 4.08$ ; (*M. varia*)  $40.12 \pm 7.36$ ,  $35.06 \pm 7.62$ .

**Table M4** Details in weight and number of valves/shells of the different categories of the Mont-Saint-Michel Bay shell sorting. NA: not applicable.

Categories	Weight [g]	Number of valves/shells
<i>O. edulis</i>	310,434.49	16,143 valves
<i>C. gigas</i>	56,860.38	8,415 valves
<i>C. fornicata</i>	2,374.02	480 shells
<i>M. varia</i>	3,106.18	1,560 valves
<i>A. ehippium</i>	298.59	566 valves
<i>P. maximus</i>	290.25	20 valves
<i>T. reticulata</i>	140.23	99 shells
<i>S. solida</i>	139.78	98 valves
<i>O. erinaceus</i>	102.01	42 shells
<i>Gibulla</i> (genus of)	77.67	53 shells
<i>B. undatum</i>	57.69	3 shells
<i>T. ferruginosa</i>	34.91	4 valves
<i>G. glycymeris</i>	29.13	7 valves
<i>L. crassum</i>	27.90	2 valves
<i>V. verrucosa</i>	25.92	2 valves
<i>M. edulis</i>	24.23	36 valves
<i>C. chinensis</i>	21.53	188 shells
<i>E. magnus</i>	10.06	6 valves
<i>D. graeca</i>	9.74	12 shells
Residue	207.56	NA

During the period prior to identification, i.e. the sorting period, five shell types were observed and identified for *O. edulis* shells: 1) single valves, 2) wide open shells, 3) semi-open or very slightly open shells, 4) totally closed shells, 5) shells with an abundance of fouling/epibiont. According to shell type, the amount of associated organisms (epifauna and/or fouling) varied

substantially. Single *O. edulis* valves showed clear signs of an older age (appearance of abraded, smooth shell surface or broken shells) than shells with still attached valves (appearance of intact ligaments). Single valves and open *O. edulis* shells (shell types 1 and 2) were easy to inspect and sort.

Regarding the slightly open/semi-open shells, three observations were made:

- 1) Some shells were dying oysters, or oysters that had recently died (yawning, and/or strong smell of decomposition; Figure M1), with decaying soft tissue inside the shell, including respective associated fauna (e.g. amphipod and isopod species);
- 2) In 358 *O. edulis* shells, one whole and intact (intact ligament) recent *M. varia* shell was found and identified (representing 46% of the sorted *M. varia* shells) with dimensions larger than the opening size of the *O. edulis* shell (Figure M3);
- 3) In 133 *O. edulis* shells *A. ehippium* were found attached (with a maximum of seven specimen found) to the inner shell (representing 31% of the sorted *A. ehippium* shells), their size not exceeding the opening size of the *O. edulis* shell (Figure M3).

In closed shells, the following observations were made after opening: oysters were either alive or dying, or they were already dead in the closed position (probably under the pressure generated by the stacking of the shells) and the ligaments had closed the two valves when they dried (they had to be unsticked). Alternatively, the valves were closed because they were filled with sand and/or mud, including respective infauna (e.g. polychaete species). For shells with an abundance of fouling/epibiont, only few algae or other aquatic plants were found (insignificant volume and weight), probably due to regular sorting procedure at the oyster farm (see section Shell collection, import and storage). Nevertheless, ca. 20% of *O. edulis* shells were scattered with gastropod eggs, ascidians and encrusting sponges (Figure M1). On most *O. edulis* shells, at least one (and in some cases several) drilling marks of predatory gastropods were observed. On several *O. edulis* shells bearing conspecific juveniles, similar drilling marks were also observed (Figure M3). A strong presence of flies in pupal and/or adult stage (Figure M1), as well as a strong odour of decay or rotting was noted. In general, additional taxonomic groups have been identified throughout the different sorting steps for shell material from both sources (Germany and France), with smaller amounts of biomass: e.g. Ophiurida, Asteroidea, Brachyura, Copepoda.

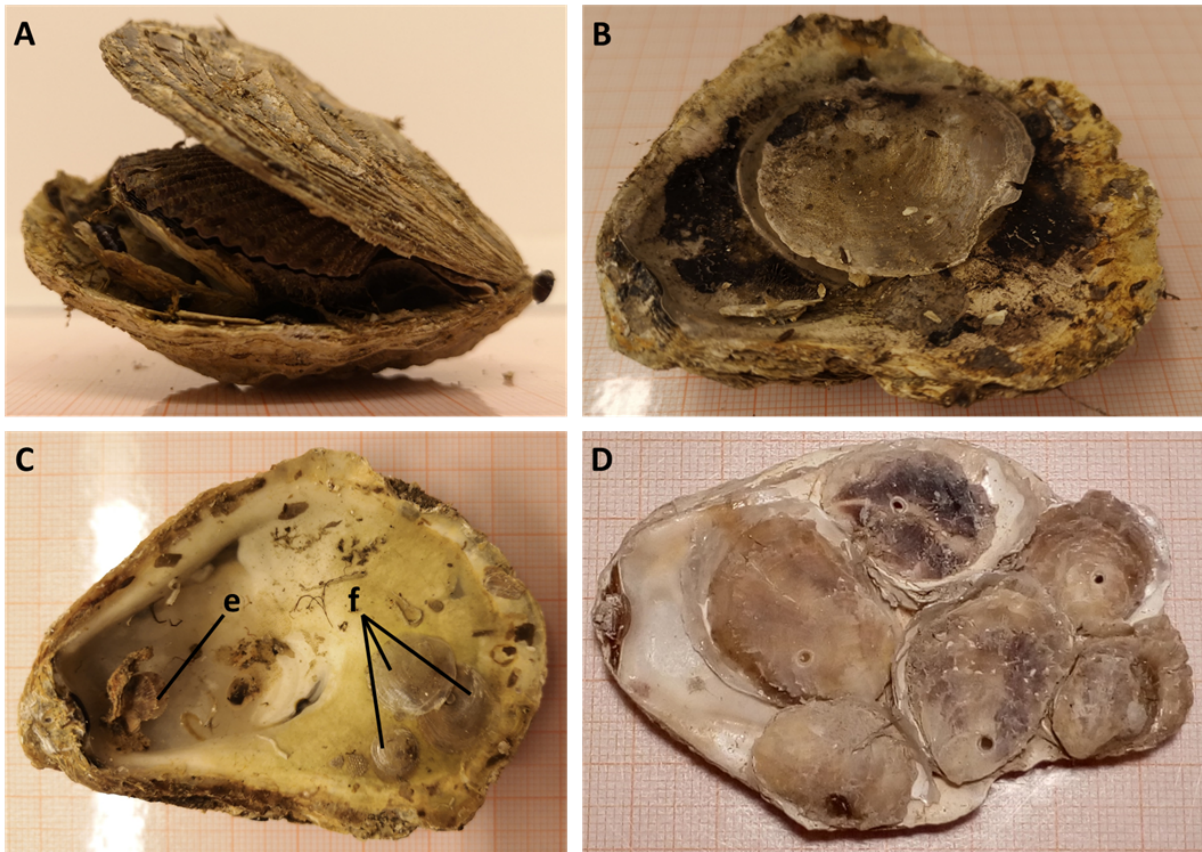

**Figure M3** Observations made during the shell-sorting phase (Import I; France). (A) Half-opened shell of *O. edulis* containing *M. varia* (attached to the valve hinge by a byssus) and a settled juvenile of *O. edulis*. (B) Interior of an *O. edulis* shell containing a large settled *A. ephippium*. (C) Interior of an *O. edulis* shell containing a juvenile of *M. varia* (e) and three juveniles of *A. ephippium* (f). (D) Six *O. edulis* juveniles settled on an *O. edulis* valve, four of which are perforated by piercing gastropods.

### Treatments and rewatering observations

Three visual observations were conducted in three steps: 1) observations during shell treatment (for treated shells); 2) observations during rewatering; 3) observations at the end of the incubation period (rewatering). During scraping or chlorine treatment of (live) oyster epibionts, whether for commercial or for research purposes, it is common to observe associated organisms escaping from the shells or small refuge cavities (e.g. worms emerging from their tubes).

With regard to weathering (OS-W), apart from the odour and flies from inside the big-bags, nothing was observed. Due to the method, no visual observations were conducted for the autoclave treatment (OS-A). For the freshwater, brine, chlorination and ozonation treatments, visual observations were possible, but no visually accessible and mobile/leaky organisms were detected (except for escaping adult flies). Barnacles, ascidians, gastropod eggs,

bryozoans and worm tubes were observed but without any movement, even no retraction. When shells (including the untreated shells) were returned to the water, the same overall observations were made: no actively moving organisms were detected. Although ascidians and (semi)floating objects were detected, these did not show signs of life. During the incubation period, no observations of mobile organisms were made either. The salinity and temperature of the aquariums were stable at  $36.51 \pm 2.57$  and  $19.86 \pm 0.23$  °C throughout the rewatering period.

The first visual observations at the end of the rewatering focused on the environment of the shells (i.e. present in the water of the aquariums and the visual status of the aquarium itself): nothing seemed to be mobile and alive except for several items in U-OS, OS, OS-W and OS-B (Table M5 and Figure M4). Additional observations: The water in the weathering treatment (OS-W) was the dirtiest, and differences in clarity were observed between the untreated shells (OS and U-OS (cleaner)). Shell bleaching and transparency of gastropod eggs were observed in aquariums with shells from the chlorination treatment. Substantial amounts of foam were observed on the surface of these aquaria (corresponding to OS-C; Figure M4). Dead flies (pupal and adult stage), as well as empty eggs of gastropods, and some dead crustaceans' parts were observed at the water surface of the aquaria (Figure M4). No worms or other organisms emerging from cavities were observed.

**Table M5** Observations made at the end of the rewatering experiment.

Controls & Treatments	Visual assessment:	Taxonomic group of visible epifauna	Individuals per tank [% of shells]	Organism status
U-OS (Control)	in water	Crustacea (parts)	Few	Dead
		Diptera (larvae)	Several	Dead
	on shell	Bryozoa	5.5	Dead
		Gastropoda (eggs)	66.7	
		Polychaeta (tubes)	11.1	Dead
OS (Control)	in water	Diptera (larvae)	Several	Dead
		Barnacles	16.7	Dead
	on shell	Gastropoda (eggs)	72.2	Dead
		Polychaeta (tubes)	16.7	Dead
		Tunicata	5.5	Alive?



OS-W (1)	in water	Diptera (larvae)	Several	Dead
	on shell	Algae	27.8	
		Barnacles	11.1	Dead
		Bryozoa	5.5	Dead
		Polychaeta (tubes)	38.9	Dead
OS-F (2)	in water	Diptera (larvae)	Several	Dead
		Gastropoda (eggs)	Several	Dead
	on shell	Barnacles	11.1	Dead
		Bryozoa	11.1	Dead
		Cnidaria	11.1	Dead
		Gastropoda (eggs)	33.3	Dead
		Polychaeta (tubes)	11.1	Dead
OS-B (3)	in water	Diptera (larvae)	Several	Dead
		Gastropod (eggs)	Several	Dead
	on shell	Bryozoa	16.7	Dead
		Cnidaria	5.5	Dead
		Gastropoda (eggs)	55.6	Dead
		Polychaeta (tubes)	22.2	Dead
		Tunicata	5.5	Alive
OS-A (4)	in water	Diptera (larvae)	Several	Dead
		Gastropoda (eggs)	Several	Dead
	on shell	Barnacles	11.1	Dead
		Bryozoa	16.7	Dead
		Cnidaria	5.5	Dead
		Gastropoda (eggs)	83.3	Dead
		Polychaeta (tubes)	33.3	Dead



OS-O (5)	in water	Diptera (larvae)	Several	Dead
		Gastropod (eggs)	Several	Dead
	on shell	Barnacles	27.8	Dead
		Bryozoa	5.5	Dead
		Cnidaria	5.5	Dead
		Gastropoda (eggs)	50.0	Dead
		Polychaeta (tubes)	50.0	Dead
OS-C (6)	in water	Diptera (larvae)	Several	Dead
		Gastropod (eggs)	Several	Dead
	on shell	Barnacles	11.1	Dead
		Cnidaria	11.1	Dead
		Gastropoda (eggs)	38.9	Dead
		Polychaeta (tubes)	38.9	Dead

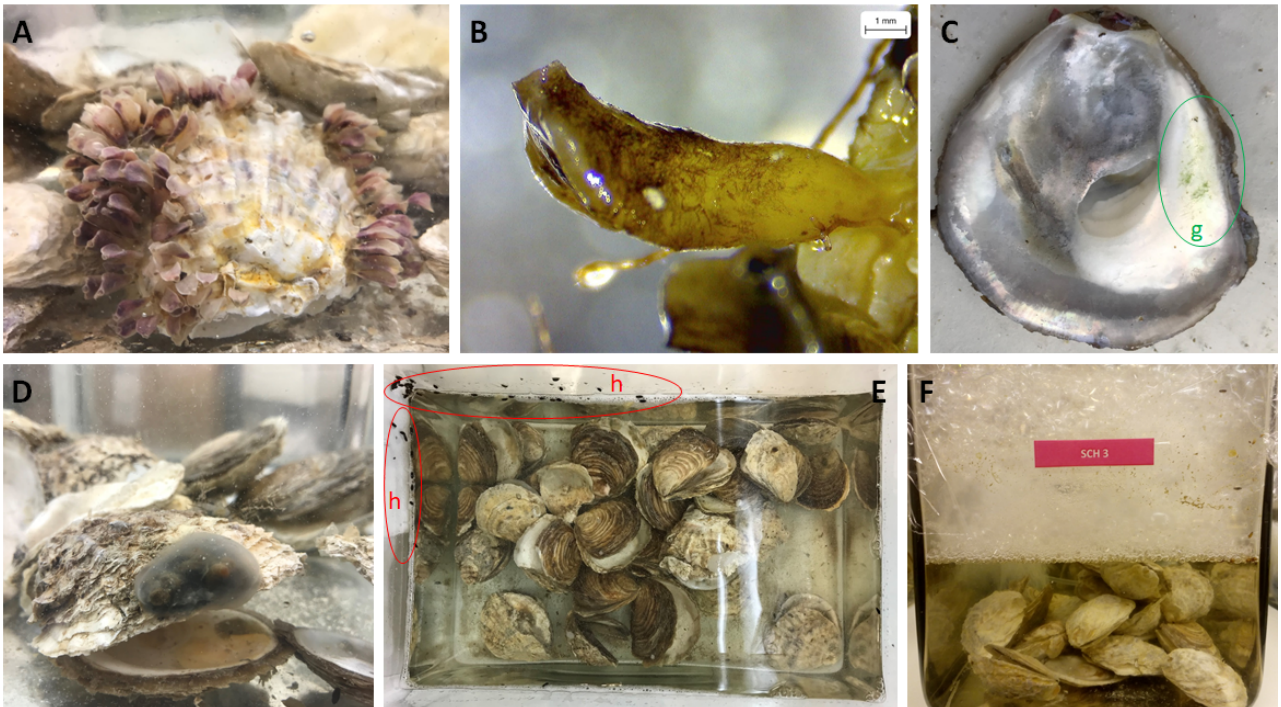

**Figure M4** Observations made at the end of the rewatering experiment. (A) Gastropod eggs on the shell of *O. edulis* (U-OS, see Table M5): status undefined (alive or dead). (B) Tunicate with the base attached to an *O. edulis* shell (OS, see Table M5): status undefined. (C) Green algae growing on an inner valve of *O. edulis* (OS-W, see Table M5): status undefined/alive;

(g) predominant area. (D) Alive tunicate on a shell of *O. edulis* (OS-B, see Table M5). (E) Presence of numerous Diptera pupae on the surface of aquaria (here an example): (h) two predominant areas. (F) Example of one of the aquaria that received shells from the chlorine treatment (OS-C): abundant foam is observed.

## Discussion

In Europe, shell material is and will be used in oyster restoration for two applications: as additional substrate to enhance recruitment in substrate-limited areas (where natural population of *O. edulis* still occurs), and as substrate for spat-on-shell production (e.g. in hatcheries) (Cohen & Zabin, 2009; Colsoul *et al.*, 2021). In the USA and Australia, various approaches have been used or are recommended to reduce the risk of translocating exotic species, pests and pathogens when translocating shell material. The most common treatment and biosecurity procedure is air-drying (weathering, curing) of the shell materials (Branigan *et al.*, 2020; Cohen & Zabin, 2009), which is strictly correlated to ambient air temperatures, precipitation and humidity. Hence, successful treatments in one environment cannot be transferred to another (Diggles, 2021). For Europe, the results of this study provide the first experimental data for shell treatments in the context of oyster restoration in temperate European environments. They underline the demand for specific protocols, as undesired species, such as the oyster drill *O. erinaceus* have been detected among the shell material.

### **The sorting: unwanted hitchhikers vs. associated fauna**

#### *Hitchhiking organisms*

In the sorted shell categories (Table M3 and Table M4), endemic species are identified for each import area (I and II), but also invasive alien species (IAS) such as *C. gigas* and *C. fornicata* found in the two shell collection areas. In the first import (France), *C. chinensis* and some species of the genus *Gibulla* should be added to the list of IAS. Despite the fact that all four species of molluscs are present in the North Sea (Gollasch & Nehring, 2006), their live translocation is prohibited. Furthermore, for historical ecology purposes, these shells should be minimised as much as possible so as not to cause misinterpretation in future malacological research. Furthermore, three other species endemic in Europe/France but recorded so far at a maximum latitude of the Belgian economic zone (according to Documented Distribution available on [marinespecies.org](http://marinespecies.org)) should be added to the shells to be minimised in transfer: *O. erinaceus*, *T. ferruginosa* and *D. graeca*. In particular, the species *O. erinaceus* is a carnivorous gastropod that predates *O. edulis* oysters. A biologically possible live transfer could have devastating consequences for the restoration of *O. edulis*: Figure M3(D) and the description by Hancock (1954) for Essex in UK shows that boring gastropods can prey on both adult and juvenile *O. edulis*. In this case, no live (estimated) *O. erinaceus* were found during the sorting process, however, the survival of marine gastropods out of water (or exposed to treatments e.g. brine bath, fresh water, ozonation, or chlorination) may vary: further research on these aspects would be important to consider, even if hand sorting is carried out.

This highlights the importance of the sorting process (and its efficiency/quality) in the case of international translocation of shells, whether freshly collected or not.

#### *Associated species and observations*

A comparison of the shell categories and epifauna found in Imports I and II is not directly possible due to the facts that, the two collection sites are located in different water bodies and regions and at different depths (Import I: littoral; Import II: sublittoral), and that the collection period and methods differ (benthic sampling vs. dredging). However, it is ecologically interesting (i.e. it gives food for thought) to find the following four shell categories at both sites: *C. gigas*, *C. fornicata*, *M. varia* and *A. ephippium*. As much as *C. gigas* and *C. fornicata* are known to be found in the collection area of import I, for these two species found in import II, the sublittoral area is generally not the area of prevalence. Furthermore, the shells appear to be relatively old, which would warrant further investigation as to the age and provenance of these shells, given that *C. gigas* was theoretically translocated to Germany in the 1960s (Neudecker, 1990) and *C. fornicata* in 1934 (Thieltges, 2003).

Concerning *M. varia* found at the German site, Caspers (1939) already describes its abundance of dead shells found in this area (Helgoland Tiefe Rinne). He even concludes that a co-community ("Austern-Chlamys-Bank") of *M. varia* and *O. edulis* existed in an earlier period (without giving dates but previous 1890s) because all shells found were dead shells. It seems that this is, according to our knowledge, the first and only one (in the accessible texts) to have developed this association of populations until today. The fact is that in France, it is only very recently that this association (*M. varia* and *O. edulis*) is found through photographic monitoring in situ on *O. edulis* beds (Pouvreau, 2017). This association is clearly observed and confirmed in this study (e.g. Table M4, Figure M3 and the section Mont-Saint-Michel-Bay) where *M. varia* uses the half-open and dead shells of *O. edulis* for settlement and growth (this cavity seems to offer additional protection to predators?). It should be noted that no specimens of *M. varia* (which were mostly recently dead and with both valves still held/intact ligaments) were found inside other shells (e.g. *C. gigas*). Given that the last recorded living specimen from Helgoland Tiefe Rinne was around the end of the 1890s (Heincke, 1896) and that data on *O. edulis* were more elaborate due to its commercial interest, an ecological question arises: did populations of *M. varia* decline (Germany) and are declining today (France) simultaneously with the decline of *O. edulis* beds?

Concerning *A. ephippium*, this species is commonly found in the German North Sea (including the area around Helgoland) and in the whole of the French west coast. However, the (living) species appears to be found in the area nearby Helgoland (personal communication) only attached to old shells of *O. edulis*. Moreover, from the sorting observations made on import I, the species seems to particularly appreciate *O. edulis* shells as a settlement support. No settled specimens were found on shells belonging to the other identified species/categories. This exclusivity is surprising here as the species is also found on other substrates notably in England, e.g. on scallop shells. Its common name (Saddle oyster) also seems to indicate that the species is associated with oysters. Here again, the question arises: is the species sufficiently associated with *O. edulis* to decline simultaneously to extinction or is this association only due to substrate availability?

## **The curing: chances and limits of eradication methods**

The presence or suspicion of life signs on *O. edulis* shells after treatment and rewatering clearly in both controls (US-O and OS) indicates that a direct use of shells, without any treatment, must be avoided in ecological restoration. As described above, the potential translocation of gastropod eggs and living gastropods represents a major hazard. For organisms settling on *O. edulis* shells, such as *A. ehippium*, their ability to resist exondation period must be determined for risk assessment purposes -although no *A. ehippium* was found alive in either Import I or III. This underlines the fact that shells must not only be sorted but also treated, even if they are dried for two weeks after collection. Two further conclusions can be taken from this experiment: (1) the brine treatment may not work e.g. for tunicates; this implies further research on the resilience of tunicates and their capacity as reservoirs for pathogens (e.g. *Bonamia ostreae*; Costello *et al.*, 2020); (2) the weathering treatment (with the method developed here, i.e. in big-bags) raised new questions: to what extent may moisture inside the big-bags (due to the containment but also to rain and seawater possibly stuck in the shells) lead to the growth of algae/bacteria? To what extent can algal spores survive over a long dry period?

Three elements that are not evaluated in this study are (1) the costs involved in each eradication method: indeed, the use of shells in restoration is also linked to the very low or even zero costs in most cases (no purchase of raw material, minimal costs residing in transport and storage); (2) the impact of the treatment time into the ecological restoration process (and project management): apart from weathering which lasts nine months, the other treatments are of a maximum duration of 48 hours; (3) the danger of using certain treatments on restoration practitioners and/or the environment (issue of effluent treatment, notably biological in the case of proximity to the coastline during a weathering treatment). These three elements are not dealt with, but we can outline that weathering treatments require relatively large storage space, can cause significant visual nuisance (flies in tourism areas, e.g. beaches in France), can cause significant odour nuisance, and can also cause a biosecurity risk if their location is close to the sea (Branigan *et al.*, 2020). The use of fresh water brings an additional cost, even if this is not quantified, as the immersion of large volumes of shells will only be achieved with many volumes of freshwater. Treatment with brine is even more expensive, and raises the question of disposal: in some cities (e.g. Bremerhaven, Germany) it is not allowed (except by special dispensation) to dispose of large quantities of seawater or brine solutions) into the city sewer. Large-scale use of autoclaves is possible using industrial autoclaves as used in the food industry (some *O. edulis* ecological restoration projects envisage this radical option; Kamermans, pers.com. 2021), however costs are high and availability/proximity of such facilities is required. Ozonation requires trained practitioners but can be done within outdoor closed tanks. Chlorination can be a problem as brine on wastewater treatment: in some cases (i.e. Helgoland, Germany), its neutralisation with thiosulphate will be requested/imposed (thus leading to additional costs: longer storage of shells in treatment tanks, control of chlorine level in water, etc.).

To our knowledge, only four articles in the scientific literature address biosecurity in relation to the use of shells in mariculture or ecological restoration: Bushek *et al.* (2004), Cohen & Zabin

(2009), Branigan *et al.* (2020) and Diggles (2021). Bushek *et al.* (2004) states that his research on reducing the risk of spreading a dinoflagellate pathogen from oysters would involve placing the shells in quarantine for 1-3 months. Cohen & Zabin (2009) reviews the state of the art to highlight other risks such as that posed by boring gastropods. He indicates that some states recommend cooking the shells as a sanitary treatment and that there is no consensus on how long weathering should take (if the method is adopted) although a minimum of 90 days is recommended. Branigan *et al.* (2020) states that the method used in Australia for shell treatment is a six-month weathering period where the oysters are stacked outdoors or the shells would be sterilised by UV sunlight. Diggles (2021) reviews the methods and risks of shell recycling in Australia for ecological restoration. He reports that different methods are used such as exposing shells to hot water, outdoor weathering, immersion in fresh water or in vinegar. He added that these methods represent high risks and that environmental factors play an important role in the effectiveness of these methods. As an example, he said that weathering in these latitudes should be extended to at least six months with a shell turnover. This underlines the importance for ecological restoration projects in Europe to develop appropriate protocols and regulations and this study is a first attempt.

### **Observation frontiers**

This study does not provide information on full eradication (100%) of the shells as the microbiological level has not been addressed: further research in microbiota culture needs to be conducted. Furthermore, for the use of shells in hatcheries (e.g. spat-on-shell production) it is essential to evaluate the potential risks posed by these shells with respect to European notifiable diseases (deployment of non-disease free oysters is not recommended in disease-free areas (e.g. Bonamiosis and Marteilliosis; zu Ermgassen *et al.*, 2020a). To do so, a literature search was carried out within this study to determine, in particular for the imports from France, how long a protozoan parasite (i.e. *Bonamia ostreae*, *Bonamia exitiosa* and *Martelia refringens*) can survive in the soft tissue of a dead/dying oyster, But to our knowledge, no such studies are available on this subject. The survival of protozoa varies according to type and species. In Wesche *et al.* (1999), the survival of *Martelia sydneyi* spores in artificial seawater reaches a maximum longevity of 35 days at 15°C and a salinity of 34. Wesche *et al.* (1999) also demonstrate that a chlorination treatment at 200 mg.l<sup>-1</sup> for four hours eradicates the protozoa spores (in seawater). Concerning *B. ostreae*, Mérou *et al.* (2020) showed that after two days, 90% of the shed parasites were no longer detected in seawater. No reference has been found for *M. refringens*.

### **Conclusions: applications and implications for oyster restoration**

The use of shells collected from mariculture or fisheries for ecological restoration of *O. edulis* undoubtedly should involve a sorting and a cleaning (curing) phase prior to further use at restoration sites or in hatcheries. The sorting or screening phase should be as exhaustive as possible, discarding closed shells, shells with rich epifauna (e.g. gastropod eggs, algae, tunicates) and any other types of shells, residues or other living organisms. A shell washing

with water (fresh or sea water) could be an intermediate step in order to deal with possible organisms in the form of spores or cysts, to eliminate at the same time the pupae of diptera, but also to deal with the problem of olfactory nuisance. For the curing phase, different treatments showed promising results: Among the tested curing treatments, weathering of shells seems to be the most interesting approach for pathogen control, epifauna eradication effluent (waste) management. However, specific research is needed, e.g. to define a weathering protocol for different European environments ((temperature dependent) time periods, shell turning intervals, heights of shell stack). Brine treatment is ineffective and its development (e.g. shell retention time in immersion) seems inadequate. Despite the described limitations, the experiments demonstrated that autoclaving, ozonation and chlorination are the most effective treatments, although also for these curing methods, large-scale experiments and the development of tailor-made protocols are needed.

## Acknowledgements

We thank the team of the centre for aquaculture research (ZAF) of AWI (Germany), for their constant and technical support. We thank Lennard Klingforth, Ute Marx, Marie Koch, Bela Buck, Kristina Kunz, and Sabine Strieben for supporting the sampling and especially, colleagues for their help throughout the supervision of this study, the experimentation, the analysis, and the writing stages. We would also like to thank all those who have helped in any way by providing bibliographic material, comments, suggestions and corrections.

## References

- Anonymous (2020) ENORI Essex Native Oyster Restoration Initiative. [www.essexnativeoyster.com](http://www.essexnativeoyster.com) update 11.2020.
- Beck MW, Brumbaugh RD, Airoidi L, Carranza A, Coen LD, Crawford C, Defeo O, Edgar GJ, Hancock B, Kay MC, Lenihan HS, Luckenbach MW, Toropova CL, Zhang G, Guo X (2011) Oyster reefs at risk and recommendations for conservation, restoration, and management. *Bioscience* **61**, 107-116. <https://doi.org/10.1525/bio.2011.61.2.5>
- Bennema FP, Engelhard GH, Lindeboom H (2020) *Ostrea edulis* beds in the central North Sea: delineation, ecology, and restoration. *ICES Journal of Marine Science*, 1-12. <https://doi.org/10.1093/icesjms/fsaa134>
- Branigan S, Fitzsimons J, Gillies CL (2020) Modern middens: shell recycling for restoring an endangered marine ecosystem in Victoria, Australia. *Ecological Management & Restoration* **21**, 1-7. <https://doi.org/10.1111/emr.12425>
- Brumbaugh RD, Coen LD (2009) Contemporary approaches for small-scale oyster reef restoration to address substrate *versus* recruitment limitation: a review and comments relevant for the Olympia oyster, *Ostrea lurida* Carpenter 1864. *Journal of Shellfish Research* **28**, 147-161. <https://doi.org/10.2983/035.028.0105>
- Buck BH (2019) Station list and links to master tracks in different resolutions of HEINCKE cruise HE542, Bremerhaven - Bremerhaven, 2019-09-30 - 2019-10-03. PANGAEA, AWI & MARUM. <https://doi.org/10.1594/PANGAEA.908148>
- Bushek D, Richardson D, Bobo MY, Coen LD (2004) Quarantine of oyster shell cultch reduces the abundance of *Perkinsus marinus*. *Journal of Shellfish Research* **23**, 369-374.
- Caspers H (1939) Die Bodenfauna der Helgoländer Tiefen Rinne [The bottom fauna of the Helgoland Tiefe Rinne]. *Helgoländer wissenschaftliche Meeresuntersuchungen* **2**, 1-112. <https://doi.org/10.1007/BF02253515>

- Clewell AF, Aronson J (2013) *Ecological Restoration: Principles, Values, and Structure of an Emerging Profession*, Island Press, Washington, USA.
- Cohen AN, Zabin CJ (2009) Oyster shells as vectors for exotic organisms. *Journal of Shellfish Research* **28**, 163-167. <https://doi.org/10.2983/035.028.0106>
- Cole HA, Knight Jones EW (1939) Some observations and experiments on the setting behaviour of larvae of *Ostrea edulis*. *ICES Journal of Marine Science* **14**, 86-105. <https://doi.org/10.1093/icesjms/14.1.86>
- Colsoul B, Boudry P, Pérez-Parallé ML, Bratoš Cetinić A, Hugh-Jones T, Arzul I, Merou N, Wegner KM, Peter C, Merk V, Pogoda B (2021) Sustainable large-scale production of European flat oyster (*Ostrea edulis*) seed for ecological restoration and aquaculture: a review. *Reviews in Aquaculture* **13**, 1423-1468. <https://doi.org/10.1111/raq.12529>
- Colsoul B, Pouvreau S, Di Poi C, Pouil P, Merk V, Peter C, Boersma M, Pogoda B (2020) Addressing critical limitations of oyster (*Ostrea edulis*) restoration: identification of nature-based substrates for hatchery production and recruitment in the field. *Aquatic Conservation: Marine and Freshwater Ecosystems* **30**, 2101–2115. <https://doi.org/10.1002/aqc.3454>
- Costello KE, Lynch SA, McAllen R, O’Riordan RM, Culloity SC (2020) The role of invasive tunicates as reservoirs of molluscan pathogens. *Biological Invasions* **23**, 641-655. <https://doi.org/10.1007/s10530-020-02392-5>
- Diggles BK (2021) Biosecurity risks related to recycling of mollusc shell waste for shellfish reef restoration in Australia. *Ecological Management & Restoration* **22**, 145-159. <https://doi.org/10.1111/emr.12472>
- Duarte CM, Agusti S, Barbier E, Britten GL, Castilla JC, Gattuso JP, Fulweiler RW, Hughes TP, Knowlton N, Lovelock CE, Lotze HK, Predragovic M, Poloczanska E, Roberts C, Worm B (2020) Rebuilding marine life. *Nature* **580**, 39-51. <https://doi.org/10.1038/s41586-020-2146-7>
- Gann GD, McDonald T, Walder B, Aronson J, Nelson CR, Jonson J, Hallett JG, Eisenberg C, Guariguata MR, Liu J, Hua F, Echeverría C, Gonzales E, Shaw N, Decler K, Dixon KW (2019) International principles and standards for the practice of ecological restoration. Second edition. *Restoration Ecology* **27**, 1-46. <https://doi.org/10.1111/rec.13035>
- Gercken J, Schmidt A (2014) Current status of the European oyster (*Ostrea edulis*) and possibilities for restoration in the German North Sea. (ed.) *BfN Skripten* 379, pp. 1-96. Federal Agency for Nature Conservation, Germany.
- Gollasch S, Nehring S (2006) National checklist for aquatic alien species in Germany. *Aquatic Invasions* **1**, 245-269. <https://doi.org/10.3391/ai.2006.1.4.8>
- Gouletquer P (2016) *Guide des organismes exotiques marins [Guide to exotic marine organisms]*, Editions Belin, France.
- Hancock DA (1954) The destruction of oyster spat by *Urosalpinx cinerea* (Say) on Essex oyster beds. *ICES Journal of Marine Science* **20**, 186-196. <https://doi.org/10.1093/icesjms/20.2.186>
- Hanke MH, Bobby N, Sanchez R (2021) Can relic shells be an effective settlement substrate for oyster reef restoration? *Restoration Ecology* **29**, e13371. <https://doi.org/10.1111/rec.13371>
- Heincke (1896) Die Mollusken Helgolands [The Molluscs of Helgoland]. *Wissenschaftliche Meeresuntersuchungen* **1**, 121-153.
- Jovic M, Mandic M, Šljivic-Ivanovic M, Smiciklas I (2019) Recent trends in application of shell waste from mariculture. *Studia Marina* **32**, 47-62. <https://doi.org/10.5281/zenodo.3274471>
- Le Neuthiec R (2013) *Les coquillages de nos rivages*, Editions Quae, Versailles, France.
- Lenth R, Buerkner P, Herve M, Love J, Riebl H, Singmann H (2018) Emmeans: Estimated Marginal Means, aka Least-Squares Means (R) v.1.5.0.
- Mérou N, Lecadet C, Pouvreau S, Arzul I (2020) An eDNA/eRNA-based approach to investigate the life cycle of non-cultivable shellfish micro-parasites: the case of *Bonamia ostreae*, a parasite of the European flat oyster *Ostrea edulis*. *Microbial Biotechnology* **13**, 1-12. <https://doi.org/10.1111/1751-7915.13617>
- Morris JP, Backeljau T, Chapelle G (2019) Shells from aquaculture: a valuable biomaterial, not a nuisance waste product. *Reviews in Aquaculture* **11**, 42-57. <https://doi.org/10.1111/raq.12225>
- Neudecker T (1990) The history of the former German oyster fishery and mariculture: 400 years of crown law on oyster (4.2.1587). *Deutsche Hydrographische Zeitschrift* **22**, 518-525.
- Pogoda B (2019) Current status of European oyster decline and restoration in Germany. *Humanities* **8**, 9. <https://doi.org/10.3390/h8010009>
- Pogoda B, Boudry P, Bromley C, Cameron TC, Colsoul B, Donnan D, Hancock B, Hugh-Jones T, Preston J, Sanderson W, Sas H, Brown J, Bonacic K, von Nordheim H, zu Ermgassen P (2020) NORA moving forward: developing an oyster restoration network in Europe to support the Berlin

- Oyster Recommendation. *Aquatic Conservation: Marine and Freshwater Ecosystems* **30**, 2031–2037. <https://doi.org/10.1002/aqc.3447>
- Pogoda B, Brown J, Hancock B, Preston J, Pouvreau S, Kamermans P, Sanderson W, von Nordheim H (2019) The Native Oyster Restoration Alliance (NORA) and the Berlin Oyster Recommendation: bringing back a key ecosystem engineer by developing and supporting best practice in Europe. *Aquatic Living Resources* **32**, 13. <https://doi.org/10.1051/alr/2019012>
- Potet M, Fabien A, Chaudemanche S, Sebaibi N, Guillet T, Gachelin S, Cochet H, Boutouil M, Pouvreau S (2021) Which concrete substrate suits you? *Ostrea edulis* larval preferences and implications for shellfish restoration in Europe. *Ecological Engineering* **162**, 106159. <https://doi.org/10.1016/j.ecoleng.2021.106159>
- Pouvreau S (2017) Underwater images of the last native oysters beds in Brittany (France). IFREMER French Research Institute for Exploitation of the Sea. <https://doi.org/10.24351/48842>
- R-Development-Core-Team (2018) R: a language and environment for statistical computing. R Foundation for Statistical Computing, Vienna, Austria.
- Sander L, Hass HC, Michaelis R, Groß C, Hausen T, Pogoda B (2021) The late Holocene demise of a sublittoral oyster bed in the North Sea. *PloS one* **16**, e0242208. <https://doi.org/10.1371/journal.pone.0242208>
- Thieltges DW (2003) Erfolgreiche Einwanderin aus Übersee – Die Amerikanische Pantoffelschnecke *Crepidula fornicata* im Wattenmeer [Successful immigrant from overseas - The American slipper snail *Crepidula fornicata* in the Wadden Sea]. *Natur und Museum* **133**, 110-114.
- Wesche SJ, Adlard RD, Lester RJG (1999) Survival of spores of the oyster pathogen *Marteilia sydneyi* (Protozoa, Paramyxea) as assessed using fluorogenic dyes. *Diseases of Aquatic Organisms* **36**, 221-226. <https://doi.org/10.3354/dao036221>
- zu Ermgassen P, Bonacic K, Boudry P, Bromley CA, Cameron TC, Colsoul B, Coolen JWP, Frankić A, Hancock B, van der Have TM, Holbrook Z, Kamermans P, Laugen AT, Nevejan N, Pogoda B, Pouvreau S, Preston J, Ranger CJ, Sanderson WG, Sas H, Strand Å, Sutherland WJ (2020a) Forty questions of importance to the policy and practice of native oyster reef restoration in Europe. *Aquatic Conservation: Marine and Freshwater Ecosystems* **30**, 2038–2049. <https://doi.org/10.1002/aqc.3462>
- zu Ermgassen P, Gamble C, Debney A, Colsoul B, Fabra M, Sanderson WG, Strand Å, Preston J (2020b) *European Guidelines on Biosecurity in Native Oyster Restoration*, The Zoological Society of London, London, UK.
- Zuur AF, Ieno EN, Walker NJ, Saveliev AA, Smith GM (2009) GLM and GAM for count data. (ed.) *Mixed effects models and extensions in ecology with R*, pp. 209-243. Springer New York, New York, USA.







# Chapter IV

## BIOSECURITY GUIDELINES FOR EUROPEAN NATIVE OYSTER HATCHERIES

Bérenger Colsoul, Monica Fabra, Daniel Cowing, Chris Hauton, Bernadette Pogoda, William Sanderson, Åsa Strand, Kelsey Thompson, Raimund Weber and Joanne Preston

Published in *European Guidelines on Biosecurity in Native Oyster Restoration* (2020)  
ISBN: 978-0-900881-82-4 / URL: <https://nora europe.eu/nora-publications>

# EUROPEAN GUIDELINES ON BIOSECURITY IN NATIVE OYSTER RESTORATION

---

NOVEMBER 2020

**Editors: Philine zu Ermgassen, Celine Gamble,  
Alison Debney, Bérenger Colsoul, Monica Fabra,  
William G Sanderson, Åsa Strand, Joanne Preston.**

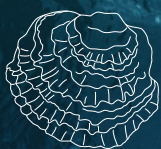

**NATIVE  
OYSTER  
NETWORK**  
UK & IRELAND



**NORA**



# CHAPTER 3:

## BIOSECURITY GUIDELINES FOR EUROPEAN NATIVE OYSTER HATCHERIES

### CHAPTER AUTHORS

**Bérenger Colsoul, Monica Fabra,** Daniel Cowing, Chris Hauton, Bernadette Pogoda, Joanne Preston, William Sanderson, Åsa Strand, Kelsey Thompson, Raimund Weber and Joanne Preston.

### INTRODUCTION

Hatchery supplied oysters can be an alternative to translocation of oysters from oyster fisheries or spatting ponds. Hatchery supply introduces the advantage of oysters coming from controlled conditions, sterilised water and a pathogen free or known pathogen environment. Any oysters that leave the biosecure zone of the hatchery before being moved, i.e. if they have had contact with the external waterbody, should be considered translocations. The purpose of this chapter is twofold. First, it is intended to provide those seeking to purchase stock from a hatchery with the information required to understand the biosecurity issues relating to hatcheries. This is intended to help the project manager pose the relevant questions and understand the biosecurity status of the purchased stock. Second, this chapter is intended to assist those seeking to establish their own hatcheries in understanding the associated biosecurity requirements. Please note that not all steps outlined here are necessary at every location. While all steps should be considered, the decisions about which are applicable should take into account the local environmental conditions and activities, e.g. the local disease status and the disease status of the intended receiving site. These guidelines are intended for use in oyster restoration activities, and were not developed for commercial aquaculture activities, not seeking to supply the restoration market.

The Native Oyster Restoration Alliance (NORA) and Native Oyster Network - UK & Ireland (NON) and the European Aquaculture Society have stated that the limited availability of appropriate seed represents a limiting factor for the progress of many native oyster restoration projects across Europe. Where no reliable and large sources of wild seed are available and cannot be developed (e.g. through spatting ponds), reef restoration depends on seed brought in from different sources. This demand can be addressed by hatchery production. A hatchery is a farm where fish or shellfish are spawned, hatched, and kept until they are large enough to be transferred to grow out systems. Bivalve hatcheries have existed for over half a century and they are currently well-established in several countries.

Most of the global marine bivalve production (89%) comes from aquaculture while only 11% comes from wild fishery. Hatcheries can provide seed not only for aquaculture, but also for restoration purposes. Relaying of hatchery-produced seed, either set on shell or as singles, can supplement existing populations and contribute to shell reserves through growth, which in turn supports larval settlement and the recovery of natural populations.

If considering hatchery-produced seed, project managers should also consider that small seed are the cohort that suffer the highest mortalities, and that either large numbers of spat will be required, or that spat may require protection and support for a grow out phase in the receiving water body before being relayed to the reef. The choice will depend on the relative cost of newly settled spat compared to the cost of growing them to the larger size, and whether there are grow-out opportunities and appropriate infrastructure at the receiving site. Consideration should also be given to the genetic status of the hatchery reared stock (see Box 2.1). See [European Native Oyster Habitat Restoration Handbook](#) (Preston *et al.* 2020) for details on restoration techniques.

Considering the risks posed to native oysters, associated species and ecosystems through diseases or invasive non-native species (INNS) introductions, hatchery biosecurity must be prioritised and implemented. Hatchery production contains complex biological processes: broodstock (adult) conditioning and spawning, larval rearing (see Figure 3.1) and setting, and optional seed rearing to a larger size before delivery. Hatcheries usually also include extra facilities for the production of large quantities of microalgae to feed all stages of the production cycle. It is essential to be aware that diseases can affect any process and level of hatchery and farm operations.

Effective biosecurity is the basis for any successful production system as it reduces production risks, minimises problem-solving costs and improves production outcomes. Furthermore, disease prevention not only protects businesses, but also has wider benefits for the environment and for communities potentially devastated by a significant disease outbreak.

## Biosecurity Measures Plan (BMP)

All aquaculture production businesses (APB's), including hatchery operations, must be authorised by the relevant authority, irrespective of scales of production. Licensing and permitting procedures depend on the respective hatchery characteristics such as site, region, species farmed, aim and scale of production.

An essential element for the authorisation process for new APB's or the renewal of existing licenses and already authorised APB's is the approved Biosecurity Measures Plan (BMP). The BMP describes defined measures to prevent or reduce the risk of introducing diseases/pests into the hatchery, spreading diseases/pests within the hatchery or the transferring diseases/pests from the hatchery to the aquatic environment. The BMP is reviewed and approved, including a site inspection, by the relevant authority. Regular inspections take place at predefined intervals to ensure that the hatchery is operating within its authorisation conditions and as defined within the BMP. It is critical that anyone establishing a hatchery is aware of the local requirements for the BMP. Understanding the structure of the BMP will also help the restoration practitioner understand the biosecurity information that is available and how to access it.

The BMP identifies and classifies diseases/pests and associated risks for site operations and oyster movements, providing the respective risk mitigation measures, via three steps:

1. Identification of major routes for potential disease/ pest transmission in oyster hatcheries.
2. Risk assessment for each disease/ pest transmission route.
3. Definition of measures to minimise the risk of disease/ pest transmission.

### Major routes of disease transmission

The identification and assessment of major routes (see Table 3.1), through which potential diseases/pests can be transmitted, considers three transmission levels:

- **Entry-level** – Transmission of disease/ pest into the hatchery.
- **Internal level** – Transmission of disease/ pest within the hatchery.
- **Exit-level** – Transmission of disease/ pest from the hatchery to the environment.

Each level will consider the transmission potential of:

- Livestock i.e. broodstock, larvae, spat.
- Feed e.g. microalgae (cultures, concentrates).
- Water i.e. intake, discharge.
- Equipment and rearing infrastructure.
- People i.e. staff, visitors.
- Settlement substrates e.g. shells, sandstone reefs.

**Table 3.1:** Overview of potential disease/pest transmission routes in oyster hatcheries.

LEVEL OF TRANSMISSION	MEANS OF TRANSMISSION	ROUTES OF TRANSMISSION
Entry-level	Livestock	e.g. import of wild broodstock.
	Feed/algae	e.g. purchase of algal paste or starter cultures from external suppliers.
	Water	e.g. intake water.
	Equipment	e.g. admission of gear from outside the hatchery.
	People	e.g. entry to the hatchery by staff and visitors.
	Settlement substrates	e.g. transfer of shells.
Internal-level	Livestock	e.g. movement of broodstock, larvae or spat between production areas.
	Feed/algae	e.g. algal cultures.
	Equipment	e.g. sharing of gear between production areas.
	People	e.g. movement of staff between different production areas.
Exit-level	Livestock	e.g. discard of mortalities.
	Water	e.g. discard of water.
	Equipment	e.g. disposal of wastes.
	People	e.g. exit of the hatchery by visitors.





**Figure 3.1:** Larval rearing systems: Conical tanks in a marine bivalve hatchery in New Zealand (top). Cylindrical tubes at Ifremer's Argenton research center in France (bottom). Photos: Bérenger Colsoul.

### Risks and risk assessment

The risk assessment analyses risks associated with each identified disease/pest transmission route. It includes the investigation and estimation of both likelihood and consequence of disease/pest transmission through each route (see Figure 3.2).

After this process, each risk is assigned to a specific category:

- Negligible (1-2) - No action required
- Low (3-5) - Ongoing monitoring required
- Medium (6-10) - Active management required
- High (12-15) - Intervention required
- Extreme (16-25) - Urgent intervention required

Medium, high, and extreme risks are considered as unacceptable and require implementation of management and intervention measures. Low risks need to be monitored over time. No action is required for negligible risks.

### Risk management measures

In order to minimise identified disease/pest transmission risks, different types of risk management measures are defined: e.g. physical (infrastructure and equipment), procedural (production practices and training) or other supporting measures. These routine measures must be implemented in the daily hatchery operations.

Based on the risk assessment, each measure can be assigned to a specific risk category to prioritise the measures (see Table 3.2), in order to provide the highest degree of biosecurity:

- Category A - Failure to implement risk management measures may result in a **critical** risk of disease/ pest transfer.
- Category B - Failure to implement risk management measures may result in a **high** risk of disease/ pest transfer.
- Category C - Failure to implement risk management measures may result in a **moderate** risk of disease/ pest transfer.
- Category D - Failure to implement risk management measures may result in a **low** risk of disease/ pest transfer.

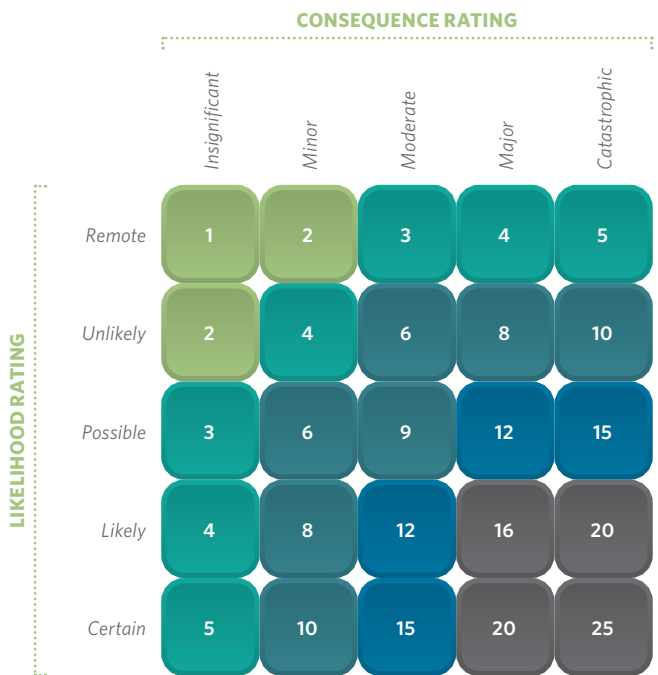

**Figure 3.2:** Risk assessment matrix, from Spark *et al.*, 2018.

**Table 3.2:** Example of BMP structure, summarising routes of disease/pest transmission, risk rating and biosecurity measures for the four different risk categories.

LEVEL OF TRANSMISSION	MEANS OF TRANSMISSION	ROUTE OF TRANSMISSION	RISK OF TRANSMISSION (FROM RISK ASSESSMENT)	RISK MANAGEMENT MEASURE	RISK CATEGORY
Entry-level	Livestock	e.g. import of wild broodstock.	Extreme	Keep broodstock in quarantine (in isolation in separate water and production area with appropriate biosecurity measures) before bringing into the main facility.	Category A (Critical)
Entry-level	People	e.g. entry to the hatchery by visitors.	High	All visitors must complete a biosecurity declaration on arrival to assess risk.	Category B (High)
Internal-level	Equipment	e.g. sharing of gear between production areas.	Medium	Do not move gear between its dedicated area to elsewhere in the hatchery.	Category C (Moderate)
Exit-level	People	e.g. entry to and exit from the hatchery.	Low	Ensure boots worn in the hatchery are not taken outside their designated production area. Visitors and staff to change into hatchery boots before entry.	Category D (Low)

## FURTHER REQUIRED DOCUMENTATION

### Record keeping

The authorisation conditions for an APB require a minimum level of record keeping. Good record keeping is necessary to demonstrate that biosecurity measures have been followed, in accordance with the hatchery biosecurity plan. In the event of a disease outbreak, these records can be used to trace the potential source of disease. They can also be used to review and improve hatchery practices and protocols. The records must be available for immediate inspection and in a format that can be copied for later analysis.

Three types of record must be taken:

- Movements record, i.e. date of movement, number of individuals, source, and destination:
  - Movement of broodstock to the hatchery.
  - Movement of broodstock, larvae and spat within the hatchery (between different biosecurity/production zones).
  - Movement of spat and adult oysters from the hatchery.
- Mortality record i.e. date, batch ID, number of mortalities, methods of disposal. Any unusual or mass mortality within the hatchery should be reported immediately to the relevant authority.



## ENTRY-LEVEL BIOSECURITY MEASURES

### Livestock

- Be aware of diseases/pests affecting oysters at donor sites and keep up to date with current disease designations and conditions.
- Carry out an inspection of incoming broodstock (see Figure 3.3) and do not accept onto the hatchery batches of oysters showing clear signs of infection or unaccounted mortality. The entry of livestock into a native oyster hatchery is a critical phase where biosecurity aspects are combined with practical aspects of zootechnics and prophylaxis. The treatment of the fouling of native oyster broodstock is required in order to avoid undesirable colonisers, predators, parasites, and other associated species. Among these undesirables, colonisers, and associated species such as barnacles (e.g. *Semibalanus balanoides*), lugworms (*Arenicola marina*) or even Pacific oyster (*C. gigas*) can spawn at the same time as the native oyster. Nowadays, two methods are used in hatcheries for the screening and identification of internal parasites and pathogens: I. Sampling/destructive screening of a few individuals for histological analysis and PCR; II. Non-destructive screening by oyster anesthesia.
- Record all movements of broodstock on arrival (movements record previously described), in order to allow proper traceability.
- New stock should be kept in isolation in separate dedicated quarantine facilities, before introducing it into the hatchery, especially if the health status is unknown (wild stock).



**Figure 3.3:** Arrival of wild native oysters at a hatchery in Helgoland, Germany. Broodstock oysters are temporarily stored, before the one-to-one scraping, washing, chlorination bath, quarantine, biometrics and tagging. Photo: Bérenger Colsoul/AWI.

- Stock health and water quality record i.e. date, batch/treatment ID, parameters tested, methods of analysis:
  - Stock health and performance.
  - Tests and laboratory results associated with – clinical disease or for health certification purposes.
  - Water quality information.
- Revision record. This provides evidence to demonstrate the biosecurity plan is being maintained and is continually reviewed and updated (annually at minimum) based on:
  - Changed biosecurity threats.
  - Ongoing learnings and new available risk management tools.
  - Changes in hatchery practices.
  - Infrastructure upgrades.

### Standard Operating Procedures (SOP)

Standard Operating Procedures (SOP) are supporting documents that provide detailed and clear instructions on how to complete either daily or emergency tasks, helping ensure every task is always carried out correctly, regardless of who is in charge. The SOP should contain:

- Title or reference code.
- Purpose and reason for having the procedure.
- List of the tasks.
- Definitions of any technical terms or acronyms used.

### Emergency response plan

The emergency response plan is an essential document for every hatchery, providing clear guidelines and procedures to apply in case of a suspected and serious emergency. It must specify:

- Specific triggers for an emergency alert, e.g. massive mortality.
- Key emergency contacts.

Extraordinary biosecurity risk management measures that need to be implemented immediately when the emergency plan is activated (e.g. hatchery access, stock movement, disposal, and quarantine, etc.).

### Biosecurity measures for native oyster hatcheries

All hatcheries have to produce a unique and personalised biosecurity plan, since they will have to deal with different biosecurity challenges. Nevertheless, each of the biosecurity measures listed in this section can be considered as a part of a generic standard approach and can be adapted to every native oyster hatchery. In cases where the broodstock are locally sourced and the oysters produced will be returned to the same water body, many of these steps may not apply. See Table 3.3 for example scenarios.

The following biosecurity measures should be considered as a basis on which existing native oyster hatcheries can help develop or confirm their protocols. Regarding developing and future hatcheries, it is important to note that this list is not exhaustive and therefore further research on potential risks needs to be conducted on a site-by-site basis.

- The removal of fouling and epibiont for native oyster broodstock can be done both physically and chemically. These methods can vary between manual scraping or use of cement mixers, followed by a hyposaline (freshwater), hypersaline (brine), or chlorine bath. Water used in this process should be UV treated if possible and used water should be treated before disposal. See Chapter 2 for further guidance on cleaning.
- Hold broodstock in quarantine as long as necessary, keeping different batches/origins of oysters separate from each other. During the conditioning period, quarantine protocol should be followed with appropriate biosecurity measures. The quarantine measures generally include a purification phase. This can be very beneficial for the rest of the hatchery operations, as it can notably reduce the bacterial level present in the initial rearing water.
- Do not move any oysters that for any reason have not been approved for release from quarantine to the production zones of the hatchery. Remove and dispose of them in the case of health conditions not improving.

### Water

Make sure the quality of water entering the hatchery is suitable for the production and that it is not contaminated/carrying pathogens.

- Water filtration down to 1µm, using bag or cartridge filters, also avoiding animal fouling potentially detrimental to the hatchery's facilities.
- Further sterilisation with UV lamps.
- Optional extra filtration by using ozone, pasteurisers, or other chemical treatments (e.g. chlorine, hydrogen peroxide, carbon filter, iodophors).
- Routine microbiological monitoring to give an indication on the effectiveness of such water filtration systems.

### Feed

- Depending upon the specific hatchery's setup and layout, dedicate a separate production area to growing microalgae to feed oysters (see Figure 3.4). **Note:** for algal cultures, the following guidelines are suggested:

- Having further filtration of the previously filtered incoming water to 0.2µm.
- Use of certified master cultures, free from contamination (reputable collections).
- Additional methods (if needed) to sterilise the water, including pasteurisation, chemical treatment, etc.).

Microalgae can also be produced in ponds, which would require a review of current procedures.

- Certified manufactured feeds (e.g. algal paste) can be considered as an alternative source of food.

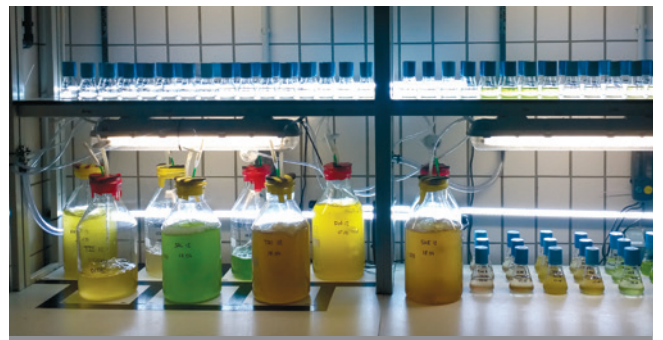

**Figure 3.4:** Microalgal culture in small volumes (intermediate phase in hatchery): 500ml up to 5l. Differences in colouration are due to the different species produced as well as their concentration. Photo: Bérenger Colsoul.

### Equipment

Prior to entering the hatchery's production zones, clean, disinfect and assess for biosecurity risk any equipment and tanks brought onto the hatchery, including those coming from the quarantine area. As examples, disinfection can be carried out by using:

- Hypochlorite solution at 200ppm concentration, for 5 minutes.
- Approved iodophor solution containing iodine at 0.5 %, for 5 minutes.
- Any other disinfection procedure approved by the supervising Quarantine Officer (*Arthur et al., 2008*).

### People (staff, visitors, students)

- Make sure both staff and students understand they share the responsibility of maintaining biosecurity in the hatchery.
- Prior to working in the hatchery, train both staff and students on:
  - Hatchery biosecurity plan.
  - Emergency response plan.
  - Role-specific tasks (SOP).
- Clearly display to all visitors the hatchery biosecurity rules and entry conditions.
- Ensure all visitors complete a biosecurity declaration on arrival, reporting any potential for cross contamination from other shellfish or fishing related sites. Increase the level of prevention applied to high-risk visitors, previously visiting hatcheries located in different areas/ecoregions.
- Both visitors and staff should adhere to the hatchery BMP, and their access should be managed through access record and signage.
- To every person entering the hatchery, apply measures to prevent disease/pest transmission, providing appropriate PPE (Personal Protective Equipment) and disinfection stations (footbaths, hand sanitisers, etc.) on entry.
- Access to sensitive areas (e.g. quarantine room) should be restricted.

## INTERNAL-LEVEL BIOSECURITY MEASURES

### Livestock

- Examine stock health conditions by regular daily inspections and keep records (stock health record previously described) for inspections by relevant authorities (see Figure 3.5).
- In case of suspicious health status of livestock, isolate and hold the oysters in separate production zones or dedicated quarantine facilities. Run additional tests, inspections and inform the relevant authorities about the results.
- Remove mortalities from the production units as soon as they occur, in order to avoid the spread of potential infection. Store dead broodstock, larvae and spat, temporarily in a freezer, but try to avoid long-term storage of waste.
- Keep a daily record of mortalities (mortality record previously described) and inform the competent authorities in case of unusual mortality events.
- Keep a record of all movements of livestock between the different production areas of the hatchery, in order to allow proper traceability. To decrease the likelihood of infection, avoid moving or transferring oysters at periods likely to be stressful.
- Avoid having different simultaneous species in production in the same hatchery area.
- Keeping broodstock at low densities may reduce the risks of pathogen contamination and spreading of diseases. However, loss of genetic diversity, through inbreeding events, should be avoided, particularly when oysters are supplied for restoration purposes (see Box 3.1).

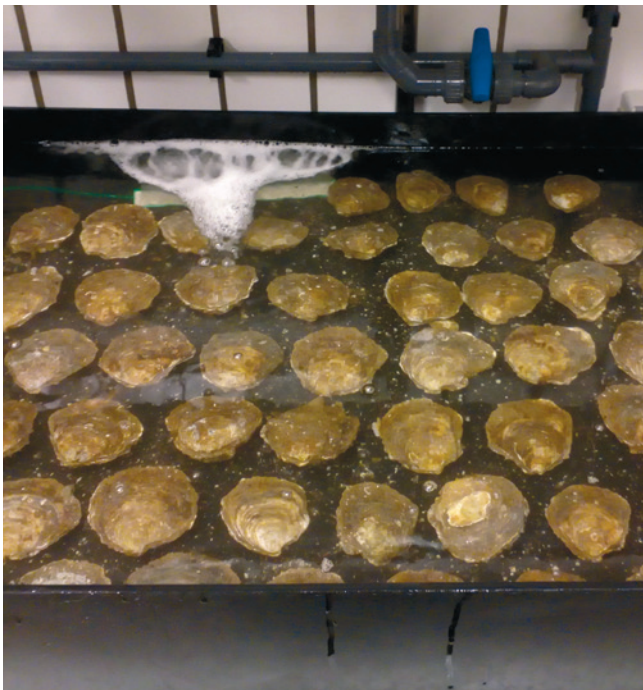

**Figure 3.5:** Broodstock conditioning: Oysters are cleaned and checked weekly. Photo: Béranger Colsoul.

### Water

- Manage the water flow in the hatchery in order to minimise the potential for diseases to spread within or between different production zones.
- Monitor and keep a daily record of water conditions within the hatchery (water quality record previously described).
- Carry out routine microbiological monitoring.

### Feed

- Monitor and maintain the algal cultures, taking care of all the species present in the culture.

### Equipment

- Keep the production lines (including pipework, tanks, tubing, valves, and pumps) separated between different production areas.
- Clean the production lines with chlorine regularly, with particular attention to the “dead-zones”.
- Assign separate equipment to different production zones, or even to different treatments or health status if necessary.
- Organise a storage for the equipment in each production zone of the hatchery, in order to avoid cross-infection. Generally, these should be off the floor and away from “wet areas”.
- If the equipment is used in multiple production zones, clean and disinfect it before and after moving it between zones. See previous section “Equipment” for disinfection methods.

### People (staff, visitors, students)

- Manage the different production areas separately, assigning separate personnel to each zone. Staff should be assigned to production areas based on risk.
- In case of staff working in multiple production areas, or people visiting the hatchery, deal with less sensitive zones first, and high-risk zones or diseased animals last, with appropriate cleaning and disinfection protocols followed when moving between different zones. See previous section “People” for preventative measures.
- Access to sensitive areas (e.g. quarantine room) should be restricted to authorised personnel only.

### Settlement substrates

Where hatcheries are producing non-single seed oysters, such as spat-on-shells, the following steps should be undertaken before using the substrates for larval settlement:

- Ensure the shells have been treated or aged appropriately for use as cultch.
- Sort the shells.
- Physically clean off dirt and remnants of fouling organisms.
- Sterilise the shells by chemicals (e.g. chlorine) or other sterilisation methods (e.g. autoclave).

For further guidance on appropriate cleaning of cultch, refer to the Chapter 2.



## EXIT-LEVEL BIOSECURITY MEASURES

### Livestock

- To ensure no infected oysters are transferred from the hatchery health certification is generally required (check with the competent authority for requirements). Protocols generally involve screening (sub-sampling or non-destructive screening method) broodstock and seeds before they leave the hatchery.
- Larvae are considered safe if prior biosecurity procedures are adhered to and monitoring results cause no concern (see Figure 3.6).
- In case of suspicious health status, oysters should be held in quarantine and additional tests/inspections should be undertaken.
- Record all movements of stock from the hatchery (movements record previously described) in order to allow proper traceability.
- Dispose of mortalities in a suitable and legal way as biological waste or incinerate them. Extra precautions must be taken if the death of a batch is suspected to be due to diseases. Certified sick oysters should be disposed separately from the rest of the waste.
- Record date and method of disposal in the mortality record.

**Note:** any product (larvae, spat, adult oysters) coming out of the hatchery, including transfers to nurseries, are considered included in the exit-level of disease/pest transmission potential route.

### Water

- Make sure larvae are not spilled into the floor drain. Mesh screens/filters should be used and maintained.
- Filter hatchery's effluents in order to prevent the release of live or dead non-compliant products (gametes, larvae, spat, feed, faeces) in the environment, especially when flow-through systems are used. See previous sections "Water" for filtration and sterilisation methods.

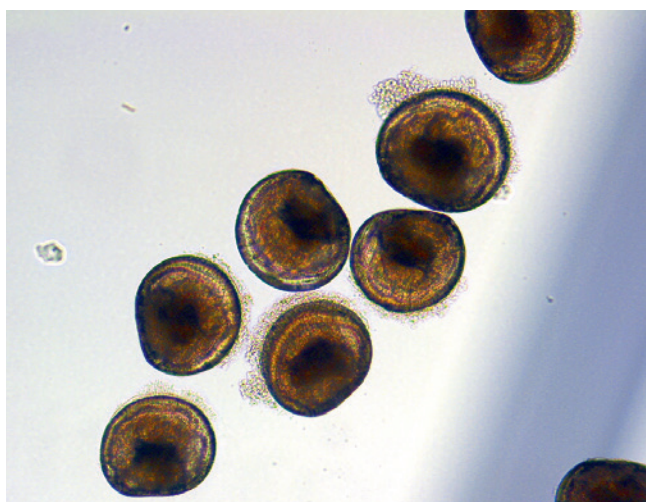

**Figure 3.6:** Larvae of *O. edulis*. Biological contamination must be controlled and minimised in order to optimise larval survival. Photo: Béranger Colsoul.

- Treat water, which has been in contact with infected oysters (e.g. effluent from quarantine room) with chlorine and dispose of it separately.
- Keep a record of wastewater disposal (date, methods, treatment, effluent, etc.).
- Carry out periodical microbiological monitoring of the effluents.

### Equipment

Clean and disinfect all the equipment coming out of the hatchery. See previous sections "Equipment" for disinfection methods.

### People (staff, visitors, students)

- Measures to prevent spread of disease from the hatchery should be applied to every person exiting the hatchery, providing dedicated disinfection stations on exit. See previous section "People".
- After being inside the hatchery, both staff and visitors must avoid being in contact with any other hatchery, seafood processors or aquatic environment, located in a different ecoregion, on the same day or within the following 24 hours.

### BOX 3.1: DUALISM BETWEEN BIOSECURITY AND GENETIC DIVERSITY

There is a link between disease susceptibility and physiological stresses caused by overcrowding. For this reason, the number of broodstock used in hatchery practices is frequently reduced to prevent disease outbreaks.

Unfortunately, this can increase the frequency of inbreeding, eventually resulting in a loss of genetic diversity in hatchery populations. The short-term success with reduced genetic diversity (boom) is manageable in food production aquaculture. In contrast, it is potentially highly problematic for restoration, where the aim is to form robust, self-sustaining, and therefore diverse populations. Loss of genetic diversity may lead to long-term failure (bust), with low survival of *Ostrea edulis* spat in the natural environment, after their translocation from the hatchery, due to their inability to adapt to local environmental conditions.

Hatchery biosecurity measures are being improved and prioritised across Europe, but the importance of genetic variability, essential for the success of *Ostrea edulis* restoration, is still underestimated.

## Two conceptual scenarios and a case study

The level of biosecurity in native oyster hatcheries can range between very strict and moderate, depending both on the aim/purpose of the production, on the disease status of the donor stock and on the designation of the receiving site. The measures outlined are guidelines which can subsequently be adapted to each hatcheries' own needs, with some measures being applied in all circumstances, and others not. The local regulatory authority is responsible for mandating minimum standards that must be met.

In order to illustrate how the outlined measures may be applied under different conditions, two contrasting scenarios are provided in this section:

- **Scenario 1:** Production of **certified oysters** in hatcheries located within **disease-free areas**, for both aquaculture and restoration purposes.
- **Scenario 2:** Production of **uncertified oysters** in hatcheries located within **disease designated areas**, only for restoration purposes.

**Table 3.3:** Summary of the main differences in application of the general biosecurity measures, between the production of **certified oysters** in hatcheries located within **disease-free areas** (Scenario 1), and the production of **uncertified oysters** in hatcheries located within **disease designated areas**, only for restoration purposes (Scenario 2).

LEVEL OF TRANSMISSION	MEAN OF TRANSMISSION	SCENARIO 1: Example biosecurity measures in disease-free certified hatcheries	SCENARIO 2: Example biosecurity measures in uncertified hatcheries
Entry-level	Livestock	As a donor site, choose only areas free from diseases/pests.	Selecting a donor site as local as possible to the hatchery location will reduce the risk of bringing in new diseases or strains of disease, and may further benefit from existing disease-resistant broodstock.
		Accept only certified disease-free batches of oysters.	No need for certifications on health status of newcomer stock.
		At the end of the conditioning period in quarantine, screen the broodstock, by sampling or preferentially by non-destructive method, before moving it to the hatchery's production areas.	There is no need to run additional tests at the end of the conditioning period, especially in case of a local donor site.
	Water Feed Equipment	Ensure a high level of biosecurity inside the hatchery, complying with all the biosecurity guidelines, also applying additional measures if necessary.	No need for strict biosecurity measures.
	People	Strict compliance of hatchery's rules and conditions, making both staff and visitors observe all the biosecurity measures.	Strict biosecurity measures for visitors coming from different ecoregions as they could transfer new invasive non-native species onto the hatchery.
Internal-level	Livestock	Apart from routine biosecurity practices, consider additional preventive measures, such as the addition of probiotics rather than antibiotics.	Apply only prophylactic measures and regular monitoring of livestock health and fitness.

LEVEL OF TRANSMISSION	MEAN OF TRANSMISSION	SCENARIO 1: Example biosecurity measures in disease-free certified hatcheries	SCENARIO 2: Example biosecurity measures in uncertified hatcheries
Exit-level	Livestock	No restrictions on the choice of the receiving site.	Receiving sites have to be located in the same area as the hatchery and the donor site.
		In case of pathogen-free production, accurate screening of products for disease detection is necessary. Certification can be carried out via the National Reference Laboratories following the respective standard protocols ( <a href="#">European Union Reference Laboratory for Mollusc Diseases (EURL) (2020) Standard Operating Procedures</a> ) within the different countries in Europe or by other laboratories approved by them.	No specific analysis is required in case of non-pathogen-free production. Carry out only regular screening, detecting, and removing only oysters clearly in a bad health status.
		Disease-free designated areas should be frequently tested if used as a source of seeds for certified hatcheries.	Movements of livestock (settlement substrates included) from restricted areas, require the permission of competent authorities.
	People	No specific restrictions for people who have been visiting disease-free hatcheries, unless they will visit other hatcheries located in different ecoregions. In this case, they should wait 24 hours before the next visit, in order to avoid transfer of INNS.	People who have been visiting hatcheries located in disease-designed areas should not be in contact with other hatcheries in the following 24 hours, change their clothes, and take all the necessary preventive measures.

The main differences between the two scenarios in Table 3.3 are related to the translocation process, concerning mainly livestock on entry and exit-level of disease transmission.

Translocation of native oysters can be reasonably undertaken in terms of biosecurity as long as they originate from areas which have an equal (or higher) health status as the receiving area. It is unnecessary and illegal to transfer oysters from a diseased area to a disease-free area.

Considering the above-mentioned translocation guidelines, all hatcheries included in Scenario 1 could receive oysters only from other disease-free areas in the same ecoregion, but hypothetically they could export oysters to areas of any disease designations.

Hatcheries included in Scenario 2 could not export oysters except to local areas. These hatcheries can indeed produce oysters only for restoration projects, which aim at replenishing local natural stocks, without involving any translocation process. They could, however, receive oysters from any area within the same ecoregion. It is advised to choose a donor site as local as the receiving site in order to avoid the risk of accidental introduction of diseases/pests. This 'local to local' scenario has the further potential benefit that any existing disease-resistance in the local population may also be maintained, maximising the chance of self-sustaining wild population of native oysters.

### BOX 3.2: CLARIFICATIONS AND RESEARCH PRIORITIES

Whereas the methods outlined above draw on existing protocols and experience, hatchery rearing of the native oyster for ecological restoration purposes is still being developed. Therefore the guidelines should be used as a starting point and planned projects should consider scientifically documenting the steps taken within their own efforts, so as to contribute to future development of standard treatments, disease detection protocols and to increase the cost effectiveness of practices. Furthermore, since biosecurity practices and protocols are operated at different locations and latitudes, the practical information listed should be reinterpreted according to the environmental context (e.g. indoor, outdoor, temperatures), (re)validated (e.g. scarce or outdated data), or further developed in the case of new scenarios (e.g. reintroduction of the species in the German North Sea). The practical actions presented here were collated based on the specific needs of ecological restoration and are therefore to be distinguished from the actions and measures applied in commercial aquaculture.

## RESOURCES

- Arthur RJ, Bondad-Reantaso MG, Subasinghe RP (2008) Procedures for the quarantine of live aquatic animals: a manual. (ed.) *FAO Fisheries Technical Paper 502*, pp. 1-89. Food and Agriculture Organization of the United Nations, Rome, Italy.
- AquaNIS (2020) AquaNIS: Information System On Aquatic Non-Indigenous And Cryptogenic Species. Available at: <http://www.corpi.ku.lt/databases/index.php/aquanis>
- Bonvarlet F (2011) Exigences réglementaires et recommandations concernant le traitement de l'eau vis-à-vis des agents pathogènes en entrée et en sortie d'écloseries conchylicoles [Regulatory requirements and recommendations for water treatment for pathogens entering and leaving shellfish hatcheries], MSc Thesis. National Veterinary School of Alfort, France.
- Buss J, Wiltshire KH, Harris JO, Deveney MR (2020) Decontamination of *Bonamia exitiosa*. *Aquaculture*, 735210.
- Caraguel CGB, Gardner IA, Hammell LK (2015) Selection and interpretation of diagnostic tests in aquaculture biosecurity. *Journal of Applied Aquaculture* 27, 279-298.
- Carnegie RB, Arzul I, Bushek D (2016) Managing marine mollusc diseases in the context of regional and international commerce: policy issues and emerging concerns. *Philosophical Transactions of the Royal Society B* 371, 1-11.
- CEFAS (2015) Protocol for inspection and approval of purification (deuration) systems - England and Wales. (ed.) *CEFAS Report Version 9*, pp. 1-43. Centre for Environment Fisheries and Aquaculture Science, Weymouth, UK.
- Cook, E.J., Macleod, A. Payne, R.D., and Brown, S. (2014) edited by Natural England and Natural Resources Wales (2015). Marine Biosecurity Planning - Guidance for producing site and operation-based plans for preventing the introduction and spread of non-native species in England and Wales.
- Cook, E.J., Payne, R.D. & Macleod, A. (2014). Marine biosecurity planning - Identification of best practice: A review. Scottish Natural Heritage Commissioned Report No. 748. Council of the European Union (2006) Council Directive 2006/88/EC of 24 October 2006 on animal health requirements for aquaculture animals. Available at: <https://eur-lex.europa.eu/legal-content/EN/ALL/?uri=CELEX%3A32006L0088>
- Coz, R., Ragot, P. (2020). Interactions des activités de cultures marines avec le milieu marin - avec focus sur les habitats et espèces Natura 2000 [Interactions of marine cultivation activities with the marine environment - with focus on Natura 2000 habitats and species]. In *OFB Référentiel pour la prise en compte des activités de cultures marines dans la préservation de l'environnement marin* (Vol. 2, pp. 1-328). Paris, France: Office Français de la Biodiversité.
- European Union Reference Laboratory for Mollusc Diseases (EURL) (2020) Standard Operating Procedures. Available at: <https://www.eurl-mollusc.eu/SOPs>
- European Union Reference Laboratory for Mollusc Diseases (EURL) (2020) National Reference Laboratories of Europe, Main Activities. Available at: <https://www.eurl-mollusc.eu/Main-activities/NRLs-network>
- Federal Agency for Nature Conservation (2020) Neobiota-Platform Germany. Available at: <https://www.neobiota-plattform.de>
- Fitzsimons, J., Branigan, S., Brumbaugh, R.D., McDonald, T. and zu Ermgassen, P.S.E. (eds) (2019). Restoration Guidelines for Shellfish Reefs. The Nature Conservancy, Arlington VA, USA.
- GB Non-Native Species Secretariat (NNSS) (2020) Available at: <http://www.nonnativespecies.org>
- Geburzi J.C., McCarthy M.L. (2018) How Do They Do It? - Understanding the Success of Marine Invasive Species. In: Jungblut S., Liebich V., Bode M. (eds) *YOUMARES 8 - Oceans Across Boundaries: Learning from each other*. Springer, Cham. pp 109-124.
- Hick P, Evans O, Looi R, English C, Whittington RJ (2016) Stability of Ostreid herpesvirus-1 (OsHV-1) and assessment of disinfection of seawater and oyster tissues using a bioassay. *Aquaculture* 450, 412-421.
- IUCN (2007) Guidelines for applying the precautionary principle to biodiversity conservation and natural resource management. Available at: [https://www.iucn.org/sites/dev/files/import/downloads/ln250507\\_ppguidelines.pdf](https://www.iucn.org/sites/dev/files/import/downloads/ln250507_ppguidelines.pdf)
- Joint Nature Conservation Committee (JNCC) (2016) Marine Method Finder. Available at: <https://hub.jncc.gov.uk/assets/d05e1bea-3453-4ac7-9c14-bac046cd05da>.
- Joint Nature Conservation Committee (JNCC) (2020) Marine Recorder. Available at: <https://jncc.gov.uk/our-work/marine-recorder>
- Le Saux JC, Pommepuy M (2003) La purification des coquillages [The deuration of shellfish]. (ed.) *IFREMER Report: Risques sanitaires liés aux coquillages*, pp. 1-17. French Research Institute for Exploitation of the Sea, France.
- Lee R, Lovatelli A, Ababouch L (2008) Bivalve deuration: fundamental and practical aspects. (ed.) *FAO Fisheries Technical Paper 511*, pp. 1-161. Food and Agriculture Organization of the United Nations, Rome, Italy.



- Ministry of the Environment, Energy and the Sea (2020) French National Strategy on Invasive Alien Species. Available at: [https://www.ecologie.gouv.fr/sites/default/files/17039\\_Strategie-nationale-especes-exotiques-invahissantes.pdf](https://www.ecologie.gouv.fr/sites/default/files/17039_Strategie-nationale-especes-exotiques-invahissantes.pdf)
- Ministry of Environment and Sustainable Development (Ministerio de Ambiente y Desarrollo Sostenible) (2018) Decreto Legislativo 230/2017, Disposizioni volte a prevenire e gestire l'introduzione e la diffusione delle specie esotiche invasive (National strategies to prevent the introduction of invasive species) Available at: [https://www.minambiente.it/sites/default/files/archivio/normativa/dlgs\\_15\\_12\\_2017\\_230\\_specie\\_esotiche\\_invasive.pdf](https://www.minambiente.it/sites/default/files/archivio/normativa/dlgs_15_12_2017_230_specie_esotiche_invasive.pdf)
- National Biodiversity Network (GB) (2020) NBN Atlas. Available at <https://nbnatlas.org>
- National Species Reintroduction Forum (2014). The Scottish Code for Conservation Translocations. Scottish Natural Heritage. 80 pp <https://www.nature.scot/scottish-code-conservation-translocations>.
- Oidtmann BC, Thrush MA, Denham KL, Peeler EJ (2011) International and national biosecurity strategies in aquatic animal health. *Aquaculture* 1-2(19):22-33.
- Official Journal of the European Union (2016) Transmissible animal diseases and amending and repealing certain acts in the area of animal health ('Animal Health Law'). Regulation (EU) 2016/429. Available at: <https://eur-lex.europa.eu/legal-content/EN/TXT/PDF/?uri=CELEX:32016R0429&from=EN>
- Otero, M., Cebrian, E., Francour, P., Galil, B., & Savini, D. (2013). Monitoring marine invasive species in Mediterranean marine protected areas (MPAs): a strategy and practical guide for managers. *Malaga, Spain: IUCN, 136*. Available at: <https://www.iucn.org/content/monitoring-marine-invasive-species-mediterranean-marine-protected-areas-mpas-a-strategy-and-practical-guide-managers>
- Palić D, Scarfe AD, Walster CI (2015) A standardized approach for meeting national and international aquaculture biosecurity requirements for preventing, controlling, and eradicating infectious diseases. *Journal of Applied aquaculture* **27**, 185-219.
- Payne, R.D., Cook, E.J. and Macleod, A. (2014). Marine Biosecurity Planning – Guidance for producing site and operation-based plans for preventing the introduction of non-native species. Report by SRSL Ltd. in conjunction with Robin Payne to the Firth of Clyde Forum and Scottish Natural Heritage 39 pp. Available at: (includes templates and examples) <https://www.nature.scot/sites/default/files/2019-02/Marine%20Biosecurity%20Planning.pdf>
- Preston J., Gamble, C., Debney, A., Helmer, L., Hancock, B. and zu Ermgassen, P.S.E. (eds) (2020). European Native Oyster Habitat Restoration Handbook. The Zoological Society of London, UK.
- Rodgers C, Arzul I, Carrasco N, Furones Nozal D (2019) A literature review as an aid to identify strategies for mitigating ostreid herpesvirus 1 in *Crassostrea gigas* hatchery and nursery systems. *Reviews in Aquaculture* **11**, 565-585.
- Scarfe AD, Cheng-Sheng L, O'Bryen PJ (2006) *Aquaculture Biosecurity: Prevention, Control, and Eradication of Aquatic Animal Disease*, Blackwell Publishing, Ames, USA.
- Scottish Government (2017) Loch Creran Biosecurity Action Plan: A local community-level biosecurity plan set up in response to a high impact species in a shellfish growing waters. Available at: <https://www.gov.scot/publications/loch-creran-community-biosecurity-action-plan>
- Spark E, Roberts S, Deveney M, Bradley T, Dang C, Wronski E, Walker M, Zippel B (2018) National biosecurity plan guidelines for Australian oyster hatcheries. (ed.) *PIRSA Fisheries and Aquaculture 2018*, pp. 1-66. Australian Government Department of Agriculture and Water Resources, Canberra, Australia.
- Strand, M., Aronsson, M., & Svensson, M. (2018) Swedish Species Information Centre (SLU) Classification of alien species' effects on biological diversity in Sweden – ArtDatabank's risk list. Swedish Species Information Centre (SLU) Available at: [https://www.artdatabanken.se/globalassets/ew/subw/artd/2.-var-verksamhet/publikationer/29.-artdatabankens-risklista/rapport\\_klassifisering\\_av\\_frammande\\_arter2.pdf](https://www.artdatabanken.se/globalassets/ew/subw/artd/2.-var-verksamhet/publikationer/29.-artdatabankens-risklista/rapport_klassifisering_av_frammande_arter2.pdf)
- Swedish Agency for Marine and Water Management (SWAM) (2020) Invasive species information. Available at: <https://www.havochvatten.se/arter-och-livsmiljoer/frammande-arter.html>
- Temple, S. (2014) North Western Inshore Fisheries and Conservation Authority Biosecurity Plan 2014 – 2019 Incorporating Marine Invasive Non-Native Species and Shellfish Disease. Available at: <https://www.nw-ifca.gov.uk/app/uploads/NWIFCA-Biosecurity-Plan.pdf>
- Turrell, W.R., Brown, L., Graham, J., Gubbins, M.J., Hermann, G., Matejusova, I., and Robinson C. (2018) Selecting a bath treatment for the marine carpet sea squirt *Didemnum vexillum*, Kott 2002 in Scottish Shellfish Aquaculture. Scottish Marine and Freshwater Science Report Vol 9 No 12 <https://data.marine.gov.scot/dataset/selecting-bath-treatment-marine-carpet-sea-squirt-didemnum-vexillum-kott-2002-scottish>
- World Organisation for Animal Health (OIE) (2020) Information on aquatic and terrestrial animal diseases, Aquatic Animal Health Code and OIE reference laboratories can be found at: [www.oie.int](http://www.oie.int). Available at: (<https://www.oie.int/en/animal-health-in-the-world/information-on-aquatic-and-terrestrial-animal-diseases/>)







# **Abstract of patent and co-authored publications**

This additional and complementary section consists of a compendium of references and contribution details of: an invention patent, five co-authored articles, two book chapters, a co-authored report, and six submitted co-authored articles which were developed in parallel to the core publications of this thesis. On the one hand, this section completes the overall picture of the work carried out during the doctoral period. On the other hand, it highlights the contribution of this thesis to the applied research in the field and integrates expectations, constraints and needs, also by considering the historical, social, geographical, technological and political context in which the ecological restoration of the European flat oyster takes place.

## **Land based method and apparatus for seeding a substrate with larvae of sessile aquatic animals**

**Authors:** Bérenger Colsoul, Bernadette Pogoda

Worldwide patent number: WO2021115533A1 (2020; Full patent: Appendix III)

Contributions: I did the conception and technical validation of the design and production operations.

Abstract: The invention relates to a land-based method for seeding a substrate with larvae of sessile aquatic animals (e.g. *Ostrea edulis*) and to a land-based device for carrying out the method, comprising a tank, the tank being filled with water and free-swimming larvae, with at least one three-dimensional substrate as a preferred habitat for the larvae, and with a temporary configuration of the substrate in the tank.

---

## **Return of the native: survival, growth and condition of European oysters reintroduced to German offshore waters**

Authors: Verena Merk, Bérenger Colsoul, Bernadette Pogoda

Published in: Aquatic Conservation: Marine and Freshwater Ecosystems 30: 2180–2190, DOI: 10.1002/aqc.3426 (2020; Open Access)

Contributions: My contribution to this paper was mainly directed towards the maintenance and culture aspects of oyster seeds, including spat, embryos and larvae observed.

---

## **Site selection for biogenic reef restoration in offshore environments: the Natura 2000 area Borkum Reefground as a case study for native oyster restoration**

Authors: Bernadette Pogoda, Verena Merk, Bérenger Colsoul, Tanja Hausen, Corina Peter, Roland Pesch, Maike Kramer, Sandra Jaklin, Peter Holler, Alexander Bartholomä, Rune Michaelis, Katrin Prinz

Published in: Aquatic Conservation: Marine and Freshwater Ecosystems 30: 2163–2179, DOI: 10.1002/aqc.3405 (2020; Open Access)

Contributions: My contribution to this paper was related to the definition and selection of the necessary biotic and abiotic criteria to be included in a site selection study for oyster restoration. Based on these criteria the most suitable sites for oyster restoration within the German Bight were determined.

---

## **NORA moving forward: developing an oyster restoration network in Europe to support the Berlin Oyster Recommendation**

Authors: Bernadette Pogoda, Pierre Boudry, Cass Bromley, Tom Cameron, **Bérenger Colsoul**, David Donnan, Boze Hancock, Tristan Hugh-Jones, Joanne Preston, William Sanderson, Hein Sas, Janet Brown, Kruno Bonacic, Henning von Nordheim, Philine zu Ermgassen

Published in: Aquatic Conservation: Marine and Freshwater Ecosystems 30: 2031–2037, DOI: 10.1002/aqc.3447 (2020; Open Access)

Contributions: My contribution to this paper was the technological aspects and actions needed related to oyster seed production in the context of European wide development of restoration projects.

---

## **Forty questions of importance to the policy and practice of native oyster reef restoration in Europe**

Authors: Philine zu Ermgassen, Kruno Bonacic, Pierre Boudry, Cass Bromley, Tom Cameron, **Bérenger Colsoul**, Joop Coolen, Anamarija Frankić, Boze Hancock, Tom van der Have, Zoë Holbrook, Pauline Kamermans, Ane Laugen, Nancy Nevejan, Bernadette Pogoda, Stéphane Pouvreau, Joanne Preston, Christopher Ranger, William Sanderson, Hein Sas, Åsa Strand, William Sutherland

Published in: Aquatic Conservation: Marine and Freshwater Ecosystems 30: 2038–2049, DOI: 10.1002/aqc.3462 (2020; Open Access)

Contributions: Of the ten topics covered in this article, my contribution was focused on four of them: biosecurity, disease management, genetic diversity, and new technologies. My task within the preparation of the paper was to review the questions collected from the network and prioritize them within my field of expertise.

---

## **Bonamia infection in flat oysters (*Ostrea edulis*) in relation to European restoration projects**

Authors: Hein Sas, Brenda Deden, Pauline Kamermans, Philine zu Ermgassen, Bernadette Pogoda, Joanne Preston, Luke Helmer, Zoë Holbrook, Isabelle Arzul, Tom van der Haven, Antonio. Villalba, **Bérenger Colsoul**, Alice Lown, Verena Merk, Nadescha Zwerschke, Emilie Reuchlin

Published in: Aquatic Conservation: Marine and Freshwater Ecosystems 30: 2150–2162, DOI: 10.1002/aqc.3430 (2020; Free Access)

Contributions: My contribution to this paper was the aspects related to the detection and necessary biosecurity measures.

---

## **Biosecurity in native oyster restoration**

Authors: Philine zu Ermgassen, **Bérenger Colsoul**, Alison Debney, Monica Fabra, Boze Hancock, Luke Helmer, Joanne Preston, William Sanderson, Åsa Strand

Book chapter published in: European Native Oyster Habitat Restoration Handbook: UK & Ireland 2020, URL: <https://nora-europe.eu/nora-publications> (978-0-900881-80-0; Open Access)

Contributions: In this chapter, my contribution included the biosecurity aspects of hatchery biosecurity and the inventory and description of relevant diseases affecting European flat oysters.

---

## **Understanding biosecurity in native oyster restoration**

Authors: Philine zu Ermgassen, Annele van den Brink, Cass Bromley, Janet Brown, **Bérenger Colsoul**, Monica Fabra, Anamrija Frankić, Azra Glover, Jakob Hansen, Janet Khan, Homère Monteiro, Stein Mortensen, Bernadette Pogoda, Dan Renton, William Sanderson, Åsa Strand

Book chapter published in: European Guidelines on Biosecurity in Native Oyster Restoration 2020, URL: <https://nora-europe.eu/nora-publications> (978-0-900881-82-4; Open Access)

Contributions: In this chapter, my contribution was the description and listing of diseases affecting bivalve populations as well as the disinfection treatment of adult oysters within a hatchery setting.

---

## **Restoration of European oyster (*Ostrea edulis*) stocks in the German North Sea**

Authors: Bernadette Pogoda, **Bérenger Colsoul**, Tanja Hausen, Verena Merk, Corina Peter

Scientific report published (German) in: BfN Skripten 582 - Wiederherstellung der Bestände der Europäischen Auster (*Ostrea edulis*) in der deutschen Nordsee, DOI: 10.19217/skr582 (2020; Open Access)

Contributions: My contribution to the report include the topics: 1) The selection of appropriate donor populations, including consideration of pathogens and parasites; consideration of genetic diversity; identification of seed oyster producers and their supply potential; 2) The selection of suitable substrates for larval settlement, including the description of laboratory tests and the recommendation of a suitable substrate for a future pilot reef in the area of Borkum Riffgrund in Germany; and reviewing the complete document.

---

## **Setting the stones to restore and monitor European flat oyster reefs in the German North Sea**

Authors: Santiago Pineda-Metz, **Bérenger** Colsoul, Miriam Niewöhner, Tanja Hausen, Corina Peter, Bernadette Pogoda

Submitted in: Aquatic Conservation: Marine and Freshwater Ecosystems

---

## **Reintroduced native oysters show low parasite burdens in offshore restoration settings**

Authors: Verena Merk, Maarten Boersma, **Bérenger Colsoul**, Tanja Hausen, Bernadette Pogoda

Submitted in: Aquatic Conservation: Marine and Freshwater Ecosystems

---

## **Potential of calcein-staining as growth marker for European oysters (*Ostrea edulis*)**

Authors: Verena Merk, Tanja Hausen, Timon Ameis, Maarten Boersma, **Bérenger Colsoul**, Bernadette Pogoda

Submitted in: Aquatic Living Resources

---

## **Come, tell me how you live: habitat suitability analysis for *Ostrea edulis***

Authors: Bernadette Pogoda, Tanja Hausen, Marko Rothe, Felix Bakker, Sarah Hauser, **Bérenger Colsoul**, Manuel Dureuil, Jochen Krause, Kathrin Heinicke, Christian Pusch, Simone Eisenbarth, Axel Kreutle, Corina Peter, Roland Pesch

Submitted in: Aquatic Conservation: Marine and Freshwater Ecosystems

---

## **GIS-based suitability modelling for the European oyster within the German Exclusive Zone of the North Sea**

Authors: Bernadette Pogoda, Sarah Hauser, Marko Rothe, Felix Bakker, Tanja Hausen, **Bérenger Colsoul**, Roland Pesch

Submitted in: GIS Science Journal

---

## **Overcoming native oyster seed production limitations to meet restoration demands in the UN decade on restoration**

Authors: Philine zu Ermgassen, Åsa Strand, Nienke Bakker, Ainhoa Blanco, Kruno Bonacic, Pierre Boudry, Gianni Brundu, Tom Cameron, Iarfhlaith Connellan, Fiz da Costa, Alison Debney, Monica Fabra, Anamarija Frankic, Celine Gamble, Matthew Gray, Luke Helmer, Zoe Holbrook, Tristan Hugh-Jones, Pauline Kamermans, Thorolf Magnesen, Pernille Nielsen, Joanne Preston, Christopher Ranger, Camille Saurel, David Smyth, Brecht Stechle, John Theodorou, **Bérenger Colsoul**

Submitted in: Aquatic Living Resources

---





# 4

# Synthesis and perspectives

The beginnings of ecological restoration as a scientific discipline date back to the 1860s (Vallauri *et al.*, 2002). Founded in southern Europe for forest reforestation, it gradually shifted to terrestrial, freshwater and finally marine ecosystems (Clewel & Aronson 2013). Oyster reefs are at risk worldwide (Baguette *et al.*) and many initiatives exist today, notably in the USA, Asia, and Australia (Gillies *et al.*, 2017; Duarte *et al.*, 2020). These initiatives have strong political and social support and are growing in many parts of the world. The ecological restoration of marine species in Europe such as oysters and their biogenic reefs has only started a few years ago and many technical and scientific aspects need to be urgently addressed in order to achieve the ambitious ecological goals. In response to this, the breadcrumb trail of this thesis has been to: 1) assimilate the necessary knowledge on the context of ecological restoration, in its geographical, historical, and political context; 2) review the available knowledge on oyster restoration initiatives around the world and learn from past experience, whether aquaculture or reseeded programmes; 3) provide a scientific answer through applied research to the questions raised by restoration initiatives involving European flat oysters.

The feasibility study “Current status of the European Oyster (*Ostrea edulis*) and possibilities for restoration in the German North Sea” (Gercken & Schmidt, 2014) and the open questions and recommendations formulated there, were the main theoretical basis for the project RESTORE, within the framework of which, this thesis was developed. Accordingly, this thesis: compiled and revised existing knowledge (Chapter I); tested and investigated important theoretical findings with experimental approaches (Colsoul *et al.*, 2020; Colsoul *et al.*, *in prep*); and actively supported the development of a European network (NORA), to support coordinated *O. edulis* restoration efforts (Pogoda *et al.*, 2020a). The main focus of this study was to identify bio-secured sources for suitable broodstock oysters and substrates, and integrate the sourcing with the development of appropriate biosecurity guidelines (zu Ermgassen *et al.*, 2020). Based on the results of the studies within this thesis, the sourcing and supply of oysters, for restoration in the German North Sea, was found to be achievable over two phases: 1) by importing quarantined adult oysters as broodstock, preferably from disease free areas, for use in hatcheries; 2) then, by producing oyster spat from these adult broodstock, for translocation and grow-out in restoration sites. A direct consequence of Chapter I was the launch of the AWI project PROCEED in 2018, funded within the Federal Program for Biodiversity by BfN, for the sustainable production of seed oysters. The findings of this thesis are highly relevant for the goal of successful seed oyster production in the future. The findings are applicable in the continued development of hatchery techniques, in line with the objectives of ecological restoration, including through adaptations of existing tools, methods and aquaculture knowledge. They also contribute to our current understanding and best practice guidelines, for the production of spat-on-shell and spat-on-reef, whilst considering and optimising the maintenance of genetic variability. The development and implementation of biosecurity standards within European oyster restoration efforts is a direct outcome from this thesis. The knowledge and experience gained through this thesis has been processed into generally published recommendations, in order to clearly define further required restoration measures, disseminate the findings to stakeholders, the public and the non-scientific community, and support the creation of a restoration programme for the German North Sea (Pogoda *et al.*, 2020a; Colsoul *et al.*, 2020; zu Ermgassen *et al.*, 2020a). The growth of *O. edulis* restoration projects in recent years, as well as national or European demands for action, in terms of biodiversity, marine conservation and rehabilitation of damaged marine

areas (FFH Directive, MSFD, OSPAR recommendations, UN Decade on Ecosystem Restoration), have subsequently increased the demand for data and guidelines for this new field. Between 2017 and 2020, following requests from the NORA community, working groups were established. In order to continue developing reliable best practice methods, extensive research is still required for oyster production, settlement substrate biosecurity, site selection, monitoring and genetic diversity (Pogoda *et al.*, 2019). The applied research on a global way of this thesis contributes to the dissemination of practical knowledge in response to practitioner demands and to direct knowledge transfer to inform political decision-makers. The review of knowledge regarding *O. edulis* breeding will help to focus research on the technical and scientific bottlenecks to seed production development. The comparison of *O. edulis* larvae settlements on substrates will allow research and restoration practitioners to have a basis for development for the specific needs of each initiative, whether it is at the scale of the hatchery or at the scale of an oyster bed in the wild. The reflection on biosecurity in hatcheries as well as on the use of imported shells discussed in this thesis aims to give first answers to ecological restoration practices. Publications from this thesis have been cited in scientific literature (e.g. Cook *et al.*, 2021, Potet *et al.*, 2021, Chapman *et al.*, in prep.) showing the knowledge uptake demands within the growing scientific field of marine restoration and the relevance of the topics addressed in this thesis. The perspectives of the research conducted during this thesis are further discussed in the following sections.

#### **4.1 Breeding techniques and its research needs for restoration**

##### **Implications for Germany**

Against the background of selecting suitable donor populations and identifying sufficient seed oyster sources, the production of seed oysters was identified as a major limiting factor for successful restoration, both in Germany and over Europe (Pogoda *et al.*, 2017; Pogoda *et al.*, 2019). Direct translocation of adult oysters is strongly discouraged due to biosecurity risks (Colsoul *et al.*, 2020; zu Ermgassen *et al.*, 2020). Considering the risks of increasing or spreading pathogens and invasive species, importing oysters for release into the natural environment is ruled out in the German context of marine nature conservation (Pogoda *et al.*, 2020b). Furthermore, large-scale translocations would run against principles of ecological restoration, which include, among others, not restoring one area to the detriment of another, as well as not increasing the pressure on extant wild oyster populations (Gann *et al.*, 2019; Pogoda *et al.*, 2019). These considerations and demands led to the development of the project PROCEED (German Federal Biodiversity Program), to establish a European flat oyster hatchery on the island of Helgoland, in order to produce healthy and bio-secured seed oysters, despite the more complex and costly technologies required (Figure 11).



**Figure 11 Ongoing construction of oyster breeding facilities on the island of Helgoland, Germany.**  
(A) Setting up the cylinders for microalgae culture (feed) ©B-Colsoul; (B) Flyer/poster at the entrance of the Helgoland Oyster Hatchery under development ©AWI/BfN).

Based on the results of this study, the first direct implication was that hatchery production of *O. edulis* is the only suitable method for use in oyster restoration within the German Bight. This implication was based on three main limitations:

- Breed-polls techniques are exclusively possible in characteristic Norwegian hydrographic conditions;
- The construction of breeding-ponds, in their traditional earthen forms, requires access and permits to transform the coastal landscape which is not feasible in Germany today;
- Wild spat collection of *O. edulis* is not possible in Germany today due to the absence of the species in the wild.

However, even if these three technologies are not immediately transferable, it is important to hold the advantages: either compensating for these through the development of new techniques within the hatchery; or by developing technologies to enable the application of the above-mentioned techniques. As an example, Lallias *et al.* (2010) showed that genetic variability is higher in breed-polls and breeding-ponds, and that the gene pool is often reduced in aquaculture hatcheries, as a result of the large difference in the number of parental organisms used.. A compensatory action here would be, for example, the systematic rotation and mixing of broodstock, and the inclusion of individual genetic monitoring, or the production of larvae in pools of several hundred adult individuals. An action to develop techniques that allow for the application of the mentioned production technologies would be, for example, the creation of floating breeding-ponds with adjustable heights. This could be achieved without transforming parts of the coastline into ponds, and independently from waiting for the high tidal coefficients to load with adequate seawater, but by having a mobile or non-impacting platform at appropriate sites with access to clear water at all times. Wild spat collection will only be of relevance in the future and only as soon as unassisted reproduction by restored oysters is

established in the natural environment. This technology will then need specific adaptations, in particular related to offshore hydrodynamic conditions of the German Bight, to be able to support the development of oyster reefs. Further investigations, related to the factors determining swarming (Maathuis *et al.*, 2019) and larval dispersal, are needed to place respective substrates and collectors at appropriate distances from the restored oyster reefs. As outlined in the conclusion of Chapter I, a number of open questions remain for the optimisation of *O. edulis* seed production, although several projects and programmes focusing on aquaculture of this species were conducted in the past. An important knowledge gap is the sex determination of *O. edulis* and the development of methods for controlling or influencing the sex ratio. This would be a major advantage for hatchery production, where the proportion of females to males is only around 14%. An accurate method of control and monitoring of the sex ratio would also help to improve the genetic variability, as, in a broodstock or population, it is currently impossible to identify the specific number of spawning males and females (Diaz-Almela *et al.*, 2004).

Further challenging topics, that have been addressed in aquaculture. for *Crassostrea gigas* in the past, could potentially increase and optimise *O. edulis* seed production for ecological restoration in the future. These include cryopreservation and transport methodologies for gametes, embryos and larvae. In the current context of spat-on-shell and spat-on-reef production, versus cultchless, single-seed oyster spat in aquaculture, the transport costs between the production sites and the restoration sites, for the seawater, substrates/reefs, oyster spat, and tanks, are staggering. The transport of larvae over long distances, by developing remote-setting trials, for example, would be a direct response to this bottleneck. Cryopreservation, and to a lesser extent the transport of larvae, could support high genetic variability in batches produced in different hatcheries.

Choices will have to be made and strategies developed, particularly in terms of genetics, as the production of oysters for restoration purposes expands. Current open questions are: 1) Should we produce disease resistant *O. edulis* seed to cope with Bonamiosis disease by accepting impacts on genetic variability? 2) Should we instead produce disease tolerant seed? If so, how? Does this process affect genetic variability? Should we care about local adaptation, and move genetic over as small distances as possible?

### **Implications for other European projects and aquaculture**

A sufficient seed oyster supply was identified in the early reports as the main limiting factor for successful European flat oyster restoration throughout Europe (e.g. Pogoda *et al.*, 2017), with this limiting situation still being the case in more recent publications (Pogoda *et al.*, 2020a; zu Ermgassen *et al.*, 2020a). Accordingly, multiple hatcheries are currently under construction in the UK, the Netherlands, Germany, Denmark, and elsewhere, to try to meet the demand in seed oyster supply for ecological restoration. Against this background, the extensive inventory, and modern reconsiderations, of classical breeding and production techniques for *O. edulis*, from regions all across its natural geographic range, is an important and sought-after baseline for *O. edulis* restoration in Europe (Chapter I). It allows for a productive and technical, as well as for a biological efficient, development of *O. edulis* production for restoration, also when

considering the growing demand, related to the increasing role and implementation of active marine conservation measures. Furthermore, this first synthesis facilitates knowledge and technology transfer and the identification of potential research directions for the respective restoration or aquaculture contexts.

### Implications for applied ecology and ecophysiology

Scientific knowledge on various aspects of *O. edulis* reproductive biology is still scarce. A better understanding of these processes would allow for numerous optimisations in seed production. As an example, a better understanding of gametogenesis, and its potential control, through the management in time and quality, could positively influence the ratio of females to males. A synchronisation of spawning, thus influencing genetic variability, would allow for a better time management of processes within a hatchery setting such as planning adequate food production. The development and establishment of non-invasive monitoring methods for gonadal status assessments, such as via magnetic resonance imaging (MRI), would be an important achievement in the optimisation process (Figure 12; Colsoul, Bock *et al.*, in prep.).

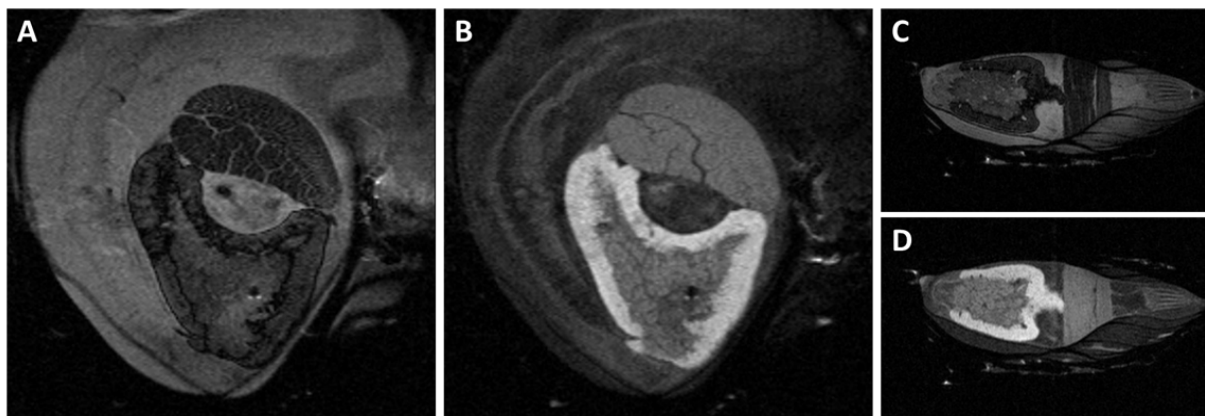

**Figure 12** MRI images of *O. edulis* and evidence of its gonads. (A) Coronal view (top view) in T2-weighted Turbo 3D Spin Echo sequence (mid slice); (B) Coronal view in T1-weighted gradient echo sequence; (C) Sagittal view (side view) in T2; (D) Sagittal view in T1. In images (B) and (D), the gonads are highlighted by white illumination (©AWI/B-Colsoul/Christian Bock).

## 4.2 Natural and nature-based substrates for restoration

### Implications of key findings in the German and in the European context

Reintroduction measures must be carried out "on a large scale" (Gercken & Schmidt, 2014), therefore, only natural and near-natural substrates were classified as suitable due to nature conservation aspects, and these were tested as part of this thesis (Colsoul *et al.*, 2020).

Negative ecological side effects of restoration activities can therefore be optimised (Pogoda *et al.*, 2020a; Colsoul *et al.*, 2020). The research results show a good suitability of natural shell materials (especially *O. edulis* and *Mytilus edulis*) for application in both the field and in hatcheries. The suitability of limestone, clay and sandstone reef substrates was also demonstrated. In addition to the biological suitability, logistical aspects, such as the availability of substrate and the necessary cleaning of shells for biosecurity purposes, must be taken into account. The conclusions on substrate suitability, presented in this thesis, are transferable to short, medium and long-term projects for the reintroduction of *O. edulis* in the German North Sea, but also have application potential for other European reintroduction projects. As substrate resources vary considerably, in quantity, quality and price, a long-term supply strategy should be developed in order to secure an efficient supply for restoration measures (Colsoul *et al.*, 2020). The two settlement approaches (in the wild and in controlled environments, such as hatcheries) revealed differences in the settlement preference of *O. edulis* larvae, both on the type and orientation of the substrate. Accordingly, the results can be applied to the two different project phases of ecological restoration of *O. edulis*, such as: for the first phase, in hatchery design, construction and related production protocols, where *O. edulis* or *M. edulis* shells can be used in 2D or 3D artificial reefs as settlement substrates; or in the second phase, as adequate settlement substrates with no fouling, and a biofilm established in fifteen days, for the increasing recruitment nearby existing or restored oyster reefs, as with the ENORI project. In this second phase, monitoring of both biological and non-biological fouling on substrate, will be required at restoration sites (Figure 13). Slaked lime has been shown to produce a high larval settlement rate, meaning that any type of substrate can be used under the lime, as long as the lime is retained, does not break, or dissolve. This opens up the possibility of using other natural materials, such as wood, which, when bare and smooth, showed only minimum settlement and lime retention rate, or innovative biodegradable materials for 3D constructions, which could be covered with lime.

### **Implications for the selection and optimisation of substrates**

Based on the results of this thesis, the strategy of producing two seed oyster types in *O. edulis* hatcheries, spat-on-shell and spat-on-reef, was developed. The patent (Colsoul & Pogoda, 2019) provides an important breakthrough in the production of 3D reefs, with homogenisation of larval settlement over the entire height and width of the reef (see section 3/Abstract; Appendix III). Several European oyster restoration projects are already building on these results, indicating their pioneering relevance in the field and successful knowledge and technology transfer (Potet *et al.*, 2021). Further optimisations, highlighted in Colsoul *et al.* (2020), for parameters influencing the settlement of *O. edulis* larvae, are currently being explored within other collaborative projects. Our collaboration partners include: CRC Bretagne Nord, France; IFREMER, France; Wageningen Marine Research, The Netherlands; and Heriot-Watt University, UK. Additional experiments are currently underway, as part of these projects, to determine the effects of parameters such as hydrodynamic conditions, and food supply, on larval settlement. Another optimisation parameter, of interest for further investigation, is the combined effects of substrate colour and biofilm on larval settlement rates (see Figure 13). First put forward for *O. edulis* by Herman (1937), the impact of substrate colour should be investigated, with and without fouling, to determine whether colour induces



a particular biofilm that indirectly influences larval preferences, as well as with and without light, to determine whether direct larval colour recognition is possible. Furthermore, the influence of substrate roughness on the settlement rate of *O. edulis* larvae should be investigated to assess whether this parameter influences settlement directly, due to, for instance, the foot attachment is favoured on rough surfaces, or perhaps indirectly, if a biofilm produces a better attachment surface, or as a combination of both (Figure 13). Optimising the production steps in the hatchery setting, and adapting them to the specific needs and goals of ecological restoration, will be a continuous process. Depending on future results from field research, after seed oyster deployment, definitions for criteria and production strategies, such as optimal, minimum and maximum density of spat per shell or per reef area, will be required. These values will likely vary, with mortality and predation rates, as well as food supply in the natural environment, showing large degrees of both temporal and spatial variability. Field research will need to address new questions, for example, does oyster density and substrate type influence the attraction of predators? Against the background of the fast development of biodegradable and nature-based substances, future research will also have to evaluate innovations for their inclusion into the selection of appropriate settlement substrates. Based on state-of-the-art research and corresponding results, hatchery production with natural or nature-based substrate can continuously respond with optimized and adapted seed oyster products, fit for purpose in marine nature conservation.

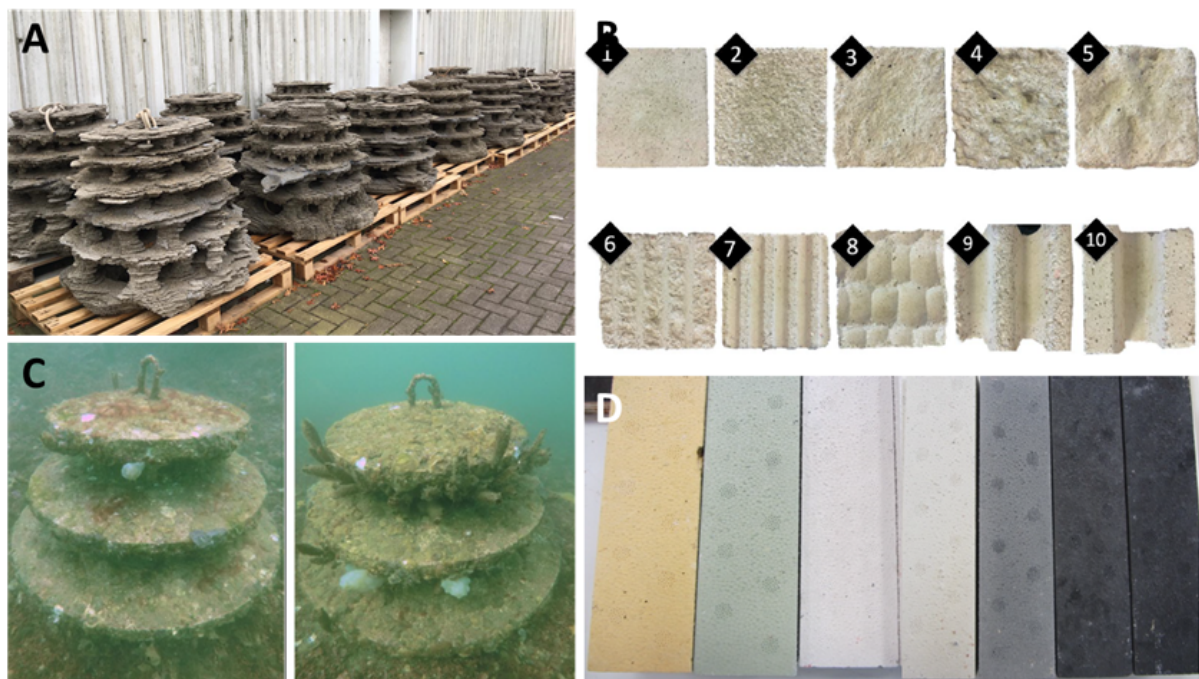

**Figure 13** Ongoing investigations on substrate optimization for larvae (*O. edulis*) settlement in France and in the Netherlands. (A) 3D reefs in the Netherlands with high roughness (©Emilie Reuchlin-Hugenholtz); (B) Ten experimental plates for settlement along a roughness gradient (Pouvreau *et al.*, 2021); (C) Underwater experiment determining the colonisation rate of artificial reefs (Pouvreau *et al.*, 2021); (D) Experimental plates for settlement along a colour gradient (Pouvreau *et al.*, 2021)

### 4.3 Biosecurity in ecological restoration

#### Direct applications of findings

The transfer of living organisms through the import of broodstock (zu Ermgassen *et al.*, 2020b) or substrate (Chapter III) is a real risk, highlighted in this thesis, (Figure 14), that should be minimized or avoided. Apart from introducing, or accentuating the presence of, exotic or invasive species into the German Bight during actions at any stage of an ecological restoration project, further additional direct risks exist. The import of broodstock into the hatchery involves the inevitable import, whether local or international, of associated living organisms. These organisms (Colsoul *et al.*, 2021) can play several detrimental roles, such as: direct predators on adult or larval oysters; colonisers, which increase competition for space, competitors for phytoplankton food resources; pathogens and parasites, inducing diseases and stress for the oysters; and also, zoo-technical disruptors, such as barnacles and lugworms, whose spawning is induced during *O. edulis* conditioning conditions, which often creates a detrimental infestation by their larvae.

In Chapter I, this thesis highlights which organisms are known to significantly affect *O. edulis* seed production, and provides suggestions for preventive actions (Colsoul *et al.*, 2021; zu Ermgassen *et al.*, 2020b). As an example, bacteria of the genus *Vibrio* affect *O. edulis* larvae by inducing up to 90% mortality (Colsoul *et al.*, 2021). For the first time, this comprehensive synthesis of known detrimental species provides the basis for the development of control, management and eradication protocols. Suggested protocols from this work include the use of PCR for screening water samples, the application of chlorination for disinfecting water, and maintaining a high renewal rate of water for decreasing and destabilizing bacterial communities.

As mentioned in section 2.3, "applied" biosecurity in ecological restoration of *O. edulis* is in its infancy and therefore each step needs to be developed, tested and scientifically validated. This is what Chapter III and the (zu Ermgassen *et al.*, 2020b) have started.

Chapter III focused on the translocation of cultch and the control and eradication of associated biota. Following on from this work, the most important next steps are to determine whether the treatments and cleaning methods are appropriate for the intended use of the settlement substrate, and if they are financially viable within ecological restoration project budgets. For example, it will be necessary to determine whether the suggested treatment methods for the substrate affects the larval settlement rate (Colsoul *et al.*, 2020). Eventually, the retention capacity of mussel shells for pollutants, such as biocides used in the food industry, prevents or highly delays the settlement of *O. edulis* larvae (Cochet, pers.com. 2020).

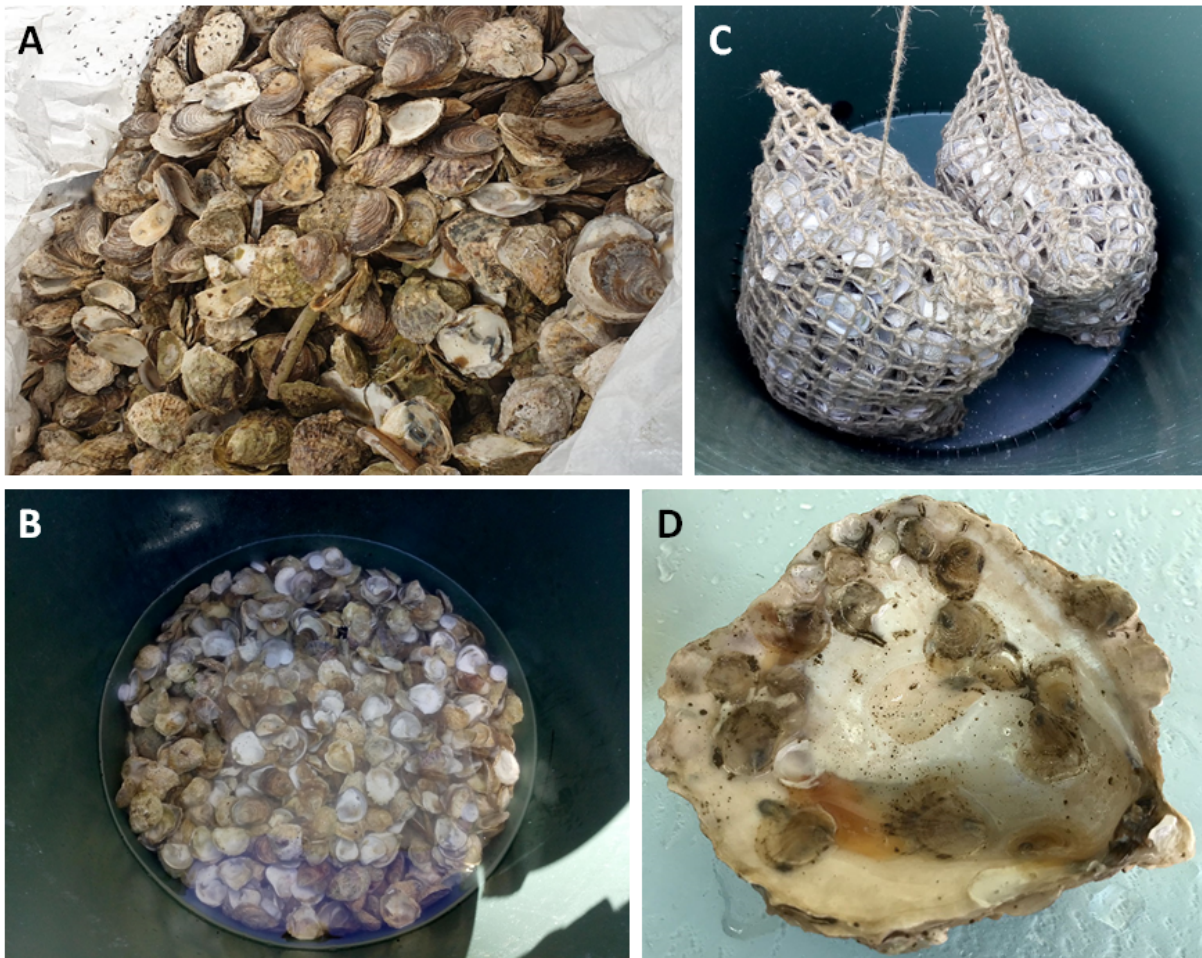

**Figure 14**      **Applied biosecurity for the production of spat-on-shell.**  
 (A) Bivalves and gastropods shell mix from aquaculture sorting process (©B-Colsoul);  
 (B) *O. edulis* shell sterilisation process presented in Chapter III, i. e. The shells are placed in tanks containing fresh water mixed with chlorine (©B-Colsoul); (C) *O. edulis* shells sorted, washed, sterilised and placed in jute bags for larval settlement in tanks (©B-Colsoul); (D) *O. edulis* shells (spat-on-shell) from the jute bags after settlement of the larvae: here numerous spats about six months old (©Corina Peter).

### Perspectives, constraints and limits of biosecurity

In aquaculture biosecurity, it is common to distinguish between two types of measures: so-called "preventive" measures, and "curative" measures. Preventive measures include management measures such as footbaths (see Chapter IV), but also disinfection by chlorination of oyster shells (e.g. broodstock). Curative measures are generally radical and are only used very rarely. An example of this second category of measures is the use of antibiotics for the disinfection of oyster broodstock, which should be avoided to limit the possible selection of resistant pathogens. The biosecurity method presented in Chapter III aims to eradicate all epibiota from the substrates through drying, sorting, disinfection treatment

and re-drying procedure. This is partly a preventive and partly a curative measure, due to the range of consecutive treatments. Another preventive method would have been to avoid the use of biogenic substrates entirely, in favour of substrates made of inorganic materials, such as baked clay (Colsoul *et al.*, 2021). Preventive measures can be of any form and are ideally non-invasive and non-destructive. New methods are emerging, including non-destructive disease detection such as screening for intracellular diseases (Bonamiosis) by anaesthetising *O. edulis* and taking a mantle sample for subsequent PCR analysis to check for genetic markers of targeted pathogens (Kamermans *et al.*, submitted). Another proposed improvement would be the development of a protocol for the detection of pathogens and parasites in the surrounding water by eDNA analysis and metabarcoding (von Gersdorff Jørgensen *et al.*, 2020). Biosafety applies equally to land-based facilities and to the natural environment. The preventive aspects of biosecurity presented in zu Ermgassen *et al.*, 2020b, can, and should be, adapted to the natural environment. Methods to control and manage inputs to the restoration site, within the restoration site itself, and outputs from the restoration site, need to be developed. Regarding input control and management, studies on the production of pathogen-free *O. edulis* seed from affected populations (i.e. tolerant oysters) are now emerging (Jacobs *et al.*, 2020), as the first guidelines, to which this thesis contributed. *In situ* management is not yet a focus of practitioners' actions, but could, for example, determine the capacity of bioremediation by other organisms, introduced simultaneously with the oysters, that would be able to remove the oyster pathogens. An example of management of outputs in the natural environment could be genetic tracing of re-implanted oysters to determine if their gametes and/or progeny are affecting other populations by reducing genetic variability.

#### 4.4 The future: Upscaling restoration and related open questions

What are the ultimate ecological goals for restored habitats (quality)? How to restore an ecosystem to its original integrity (quality)? Which aerial extent is desired to be restored (quantity, connectivity)? Which role play existing marine protected areas for achieving these goals? How to stabilise restored habitats? Are multi-species approaches an option? How to increase restoration progress and scale?

Future restoration scenarios will be guided by interdisciplinary approaches answering these open questions and coordinating the relevant scientific advances. Some have seen, see or will see a futile gamble, others will see an ecological necessity, still others will see that through these very specific efforts to reintroduce an engineering species there is a possibility, if not an opportunity, to acquire knowledge about the functioning of ecosystems, their establishment, their dynamics, their resilience, and/or their transformation. Perhaps we are gaining knowledge here that might one day be useful for the establishment of life on other planets?

In the first instance, a stable and consistent production of restoration materials (livestock and substrates) will need to be established. This is true both for the case of oyster restoration in Germany and for the rest of Europe with regard to *O. edulis*. Indeed, as described in the introduction and in Chapter I, technologies exist in aquaculture but these need to be adapted to the needs of restoration, be it in the local (e.g. hatchery implementation) or global (e.g. genetic variability, disease tolerance) context. One of the answers provided by this thesis is the production of spat-on-shell in a hatchery in Germany. The successful and sustainable



establishment of a bivalve hatchery requires a few years of running in and learning the production tools (including the qualities of the sea water). The level of knowledge of the attributes of the natural environment, the ecophysiology of *O. edulis*, and the lack of stable standards/guidelines in *O. edulis* hatcheries do not allow the creation of such an establishment without a minimum of research and development. When these steps have been completed, the capacity of the hatchery(s) will have to be increased considerably, e.g. if designated areas in MPAs are to be restored. Future scenarios with self-sustaining reefs to regenerate (recruitment and resilience) are to be evaluated, as well as new production methods such as floating breeding-ponds.

Large-scale production with regard to substrate is also to be conceived in terms of shell treatments (Chapter III, IV) or the creation of alternative substrates. Mass deployment of recruitment and/or seeded substrates should be investigated. Indeed, if it is a question of deploying additional substrates in the case of local recruitment on a restored site, the specific seasonal deployment needs to be assessed and considered (e.g. not burying the restored stocks under the new substrate). Can the density of the introduced substrate influence the influx of predators or competitors? Would additional substrate variety increase biodiversity?

In terms of habitat quality, ecological restoration initiatives around the world and across habitat types (Gann et al. 2019) suggest that the restoration of *O. edulis* in the German North Sea will not lead to the original habitat of the past nor achieve the (largely unknown) historical baseline, but rather proceed to a new habitat. Understanding and anticipating the complex transformations within the ecosystem, i.e. instability and succession during the restorative continuum (Gann et al. 2019) are relevant aspects of applied ecological research. This includes the role of multi-species approaches which may have the potential to accelerate the recovery of a restored habitat (McAfee et al., 2021). Relevant candidates of different trophic levels or supporting different functional traits are currently discussed, e.g. associated bivalves (*Mimachlamys varia*) or important predators such as skates (*Raja clavata*). Specific research on such integrated restoration concepts will help to optimize restoration success.

#### **4.5 Synthesis and conclusion**

Worldwide, ecological restoration of oysters and of other biogenic habitat forming species is a new and fast evolving topic of great importance. This thesis supports not only the scientific basis for the biological and technical feasibility of restoration projects/programmes, but also promotes the knowledge transfer to the entire non-academic practitioner community through various exchanges and interdisciplinary collaborations.

As a link to the feasibility study for a restoration of *O. edulis* in the German Bight in 2014 (Gercken & Schmidt, 2014), this thesis is the immediate next step in applied ecology. The knowledge of *O. edulis* biology, stressors, genetics reviewed comprehensively, critically but also applied to the reintroduction in the different chapters of this thesis provides a solid basis on which to build a guideline for future research. Concrete answers to the questions posed in the Gercken & Schmidt (2014) study are identified through this thesis, e.g. donor population selection, substrate selection, breeding technique selection, genetic status, hatchery reef

creation technique; furthermore, the results obtained during this thesis lead to new questions, e.g. on the density of the restored population (spatial dimension of the reef), on the minimum population restored for self-development (and resilience to stressors; i.e. number of oysters and minimum genetic pool), on the deployment/supply of additional substrate during the swarming period, on the sustainable and optimised deployment of oysters or mini-reefs on the sea bed, on the ecological reaction of the environment in which the oysters are restored in terms of predation, spatial competition notably for the settlement of the larvae.

The conservation or, if necessary, restoration of the habitat type "reefs" including its characteristic species is obligatory according to the EU Habitats Directive (Directive 92/43/EEC). These natural habitats are to be included in the Natura 2000 network of protected areas (Annex I of the Habitats Directive). In Germany, *O. edulis* reefs are defined as biogenic reef builders, based on which a favourable conservation status of the habitat type "reef" can be assessed (BfN, 2017). In addition, according to OSPAR, the species is considered a keystone species with special ecological importance, which is also threatened with extinction. The main factors considered to limit natural restoration of *O. edulis* oyster reefs are intensive bottom-contact fishing, a lack of parent stock to sustain the population, and a lack of suitable substrate for larval settlement (Kennedy & Roberts, 1999; Gercken & Schmidt, 2014; Pogoda *et al.*, 2020b).

The reintroduction of the European flat oyster in the German Bight is currently being implemented as a nature conservation measure. This sets the frame for ecological, as well as legal, restraints and specifications concerning the production of spat, the import of oysters from foreign populations, as well as the choice of sustainable substrate. Against this background, this thesis achieved the collection of relevant published knowledge in the field, as well as making important progress by providing the scientific groundwork to develop appropriate technological solutions, for long-term and large-scale restoration.

One of the most restrictive bottlenecks for upscaling oyster restoration projects within Europe and especially in Germany has been found to be the limited availability of seeds. According to Chapter I, hatchery production was defined as the appropriate production technology meeting the needs of *O. edulis* restoration in Germany. Future research and production hatcheries for restoration need to be adapted from aquacultural and/or commercial oyster hatcheries, changing the focus from large-scale production for the consumer towards the demands of ecological restoration practice. These adaptations include: the development of a set of appropriate production techniques; the development of pathogen free, or pathogen tolerant, *O. edulis* seed production; and a stable, sustainable, and reliable *O. edulis* seed production, in terms of quantity and quality. The synthesis of knowledge on *O. edulis* seed production techniques, as well as on the reproductive biology of *O. edulis*, now provides an overview of the actions to be taken for the development of new research topics. In Germany, an immediate reaction on the limited seed availability for oyster restoration, presented in the conclusion of the Chapter I review, a research and production hatchery for restoration was granted and is now operated on the island of Helgoland, funded within the German Federal Program for Biodiversity.

The reproduction cycle of *O. edulis* is complex and is influenced by a diverse range of biotic and abiotic factors, which need to be addressed and optimized within a hatchery. A crucial

phase is the settlement of larvae and the subsequent metamorphosis to spat. In the commercial oyster production industry, substrate is chosen with a low cost, high outcome goal, not focusing on the sustainability of materials used. Ecological restoration and marine conservation measures support only natural or semi-natural substrates and materials naturally occurring in environment of the German North Sea. Chapter II of this thesis addressed these demands and defined a selection of appropriate settlement substrates for different applications (*in situ* or *in vitro*). These outcomes directly address practical issues of oyster restoration and have already been implemented into hatchery protocols in Germany. Furthermore, they correspond to the objectives of applied research and knowledge transfer through the active contribution to the NORA production-working group. This substrate selection resulting from the experimental work in this study provides relevant information, not only for the production of spat-on-shell and spat-on-reef, but also for areas where dedicated restoration sites are depleted of natural settlement substrate. In those areas, sufficient availability of settlement substrate can be achieved by building up a basis of shell material when larvae are present. However, this raises the question as to the origin of those materials, and how to import them with the high biosecurity standards needed. These are highly relevant topics and were addressed in Chapter III.

Chapter III investigated the risk of pathogen and invasive species transport, when importing sufficient substrate, and provided recommendations for appropriate treatment options. The findings on substrate biosecurity treatments presented here are transferable to short-, medium- and long-term projects for the restoration of *O. edulis* in the German North Sea, but can also be applied in the context of other marine habitat restoration projects. Questions remain concerning the developed treatment method and significant research is still to be conducted in the field of applied restoration biosecurity. Since substrate resources vary greatly in quantity, quality and price, a long-term supply strategy should be developed (Colsoul *et al.*, 2020; Pogoda *et al.*, 2020b).

The research results of this thesis suggest a number of relevant next steps. These steps include: the operation of a restoration-focused oyster hatchery in Germany; the production of spat-on-shell and spat-on-reef; the identification of factors optimizing larval settlement and seed production techniques; as well as further research on the optimisation of biosecurity. Due to legal requirements, these steps are mandatory for the German restoration progress, but will also contribute to the wider European context. Section 3 of this thesis (Abstracts) provides many examples of European collaborations across the NORA network and shows the contribution of all European partners to design and implement guidelines for biosecurity, and to achieve a successful restoration of the native oyster. Currently, the working groups are collaborating on progress in spat production, with a focus on disease tolerance and genetic diversity, as well as on joint monitoring standards.

The four chapters of this thesis outline relevant methods of *O. edulis* hatchery production in Germany and in Europe, as well as criteria for future natural recruitment in the field. Against this background, this thesis integrated existing knowledge in oyster production with new scientific insights to support future technical solutions for the implementation of long-term restoration measures.

In the context of the transition from the UN decade on biodiversity (2011-2020) to the UN decade on ecosystem restoration (2021-2030), this thesis is highly relevant. By supporting the successful reintroduction of the European flat oyster, and its associated species community, in the German North Sea, it contributes to enhancing biodiversity, and to restoring a degraded but ecologically important marine habitat. Furthermore, it contributes to the timely implementation of marine ecosystem restoration as active conservation measures.





# 5

# References

- Anonymous (1983) Huitres, Moules, Coquillages de France [Oysters, Mussels, Shellfish from France], Comité Interprofessionnel de la Conchyliculture.
- Anonymous (2006) Cultured Aquatic Species Information Programme: *Ostrea edulis* (Linnaeus, 1758). [http://www.fao.org/fishery/culturedspecies/Ostrea\\_edulis/en](http://www.fao.org/fishery/culturedspecies/Ostrea_edulis/en) update 12.2019.
- Anonymous (2019) Society for Ecological Restoration. [www.ser.org](http://www.ser.org) update 03.2019.
- Anonymous (2021) La Plate, l'Huître Bretonne Originelle [The flat oyster, the original Breton oyster]. [www.huitreplate.fr](http://www.huitreplate.fr) update 03.2021.
- Barthélemy-Saint Hilaire J (1887) *Traité de la Génération des Animaux, Volume 1, Oeuvres d'Aristote*, Hachette et Cie, Paris, France.
- Bayne BL (2017) *Biology of Oysters. Developments in Aquaculture and Fisheries Science Volume 41*, Elsevier Science, Academic Press, London, UK.
- Beck MW, Brumbaugh RD, Airolidi L, Carranza A, Coen LD, Crawford C, Defeo O, Edgar GJ, Hancock B, Kay MC, Lenihan HS, Luckenbach MW, Toropova CL, Zhang G, Guo X (2011) Oyster reefs at risk and recommendations for conservation, restoration, and management. *Bioscience* 61, 107-116. <https://doi.org/10.1525/bio.2011.61.2.5>
- Benovic A (1997) The history, present condition, and future of the molluscan fisheries of Croatia. In: MacKenzie CL, Burrell VG, Rosenfield A, Hobart WL (ed.) *The History, Present Condition, and Future of the Molluscan Fisheries of North and Central America and Europe*, pp. 217-226. Scientific Publications Office, NMFS, NOAA, Seattle, USA.
- BfN (2017) Die Meeresschutzgebiete in der deutschen ausschließlichen Wirtschaftszone der Nordsee: Beschreibung und Zustandsbewertung. *BfN-Skripten* 477, 486.
- BfN (2020) Managementplan für das Naturschutzgebiet „Borkum Riffgrund“ (MPBRg). Bundesamt für Naturschutz, Bonn: 123 S.
- Bromley C, McGonigle C, Ashton EC, Roberts D (2016) Bad moves: Pros and cons of moving oysters - a case study of global translocations of *Ostrea edulis* Linnaeus, 1758 (Mollusca: Bivalvia). *Ocean & Coastal Management* 122, 103-115. <https://doi.org/10.1016/j.ocecoaman.2015.12.012>
- Buestel D, Ropert M, Prou J, Gouilletquer P (2009) History, status, and future of oyster culture in France. *Journal of Shellfish Research* 28, 813-820. <https://doi.org/10.2983/035.028.0410>
- Buschbaum C, Saier B, Reise K (2003) Karl August Möbius und Friedrich Dahl. *Biologie in unserer Zeit* 33, 399-400. <https://doi.org/10.1002/biuz.200390145>
- Cheong SM, Silliman B, Wong PP, van Wesenbeeck B, Kim CK, Guannel G (2013) Coastal Adaptation with Ecological Engineering. *Nature Climate Change* 3, 787-91. <https://doi.org/10.1038/nclimate1854>
- Clewell AF, Aronson J (2013) *Ecological Restoration: Principles, Values, and Structure of an Emerging Profession*, Island Press, Washington, USA.
- Coen LD, Brumbaugh RD, Bushek D, Grizzle R, Luckenbach MW, Posey MH, Powers SP, Tolley SG (2007) Ecosystem services related to oyster restoration. *Marine Ecology Progress Series* 341, 303-307. <https://doi.org/10.3354/meps341303>
- Cole HA (1942) Primary sex-phases in *Ostrea edulis*. *Journal of Cell Science* 83, 317-356.
- Colsoul B (2013a) Écloserie-nourricerie bivalves de Roem van Yerseke : optimisations de production [Bivalve hatchery-nursery of Roem van Yerseke: production optimisation]. MSc. Thesis. University of Montpellier & Montpellier SupAgro, France.
- Colsoul B (2013b) Faisabilité d'écloserie de bivalves marins : un outil opérationnel d'aide à la décision [Feasibility of marine bivalve hatchery: an operational decision support tool]. MASc. Thesis (mimeo). University of Montpellier, France.
- Colsoul B, Boudry P, Pérez-Parallé ML, Bratoš Cetinić A, Hugh-Jones T, Arzul I, Merou N, Wegner KM, Peter C, Merk V, Pogoda B (2021) Sustainable large-scale production of European flat oyster (*Ostrea edulis*) seed for ecological restoration and aquaculture: a review. *Reviews in Aquaculture* 13, 1423-1468. <https://doi.org/10.1111/raq.12529>

- Colsoul B, Peter C, Pouil S, Merk V, Pogoda B (in prep) Discard shells from mariculture and fisheries for flat oyster (*Ostrea edulis*) restoration: observations and implications. *Management of Biological Invasions*.
- Colsoul B, Pogoda B (2019) Landbasiertes Verfahren und Vorrichtung zum Besatz eines Trägerkörpers mit Larven von sessilen Wassertieren [Land based method and apparatus for seeding a substrate with larvae of sessile aquatic animals], German Patent Nr.: AWI1903CP/20191201DE, Germany.
- Colsoul B, Pouvreau S, Di Poi C, Pouil P, Merk V, Peter C, Boersma M, Pogoda B (2020) Addressing critical limitations of oyster (*Ostrea edulis*) restoration: identification of nature-based substrates for hatchery production and recruitment in the field. *Aquatic Conservation: Marine and Freshwater Ecosystems* 30, 2101–2115. <https://doi.org/10.1002/aqc.3454>
- Cook RL, Sanderson WG, Moore CG, Harries DB (2021) The right place at the right time: Improving the odds of biogenic reef restoration. *Marine Pollution Bulletin* 164, 112022. <https://doi.org/10.1016/j.marpolbul.2021.112022>
- Coste JMCV (1861) *Voyage d'Exploration sur le Littoral de la France et de l'Italie*, Imprimerie Impériale, Paris, France. <https://doi.org/10.5962/bhl.title.39381>
- Culloty SC, Mulcahy MF (2007) *Bonamia ostreae* in the native oyster *Ostrea edulis*. a review. (ed.) *Marine Environment and Health Series No. 29*, pp. 1-40. Marine Institute, Ireland.
- Davaine C (1853) *Recherches sur la Génération des Huitres*, E. Thunot et Cie, Paris, France.
- David AA (2020) Oyster reef restoration and biological invasions: an overlooked or a non-issue? *Frontiers in Marine Science* 7. <https://doi.org/10.3389/fmars.2020.544691>
- Decler M (2010) WoRMS image (Muiltje, added on 2010-10-21). [www.marinespecies.org](http://www.marinespecies.org) update 03.2021.
- de Groot RS, Wilson MA, Boumans RMJ (2002) A typology for the classification, description and valuation of ecosystem functions, goods and services. *Ecological Economics* 41, 393-408. [https://doi.org/10.1016/S0921-8009\(02\)00089-7](https://doi.org/10.1016/S0921-8009(02)00089-7)
- Diaz-Almela E, Boudry P, Launey S, Bonhomme F, Lapègue S (2004) Reduced female gene flow in the European flat oyster *Ostrea edulis*. *Journal of Heredity* 95, 510-516. <https://doi.org/10.1093/jhered/esh073>
- Dijkema R (1997) Molluscan fisheries and culture in the Netherlands. In: MacKenzie CL, Burrell VG, Rosenfield A, Hobart WL (ed.) *The History, Present Condition, and Future of the Molluscan Fisheries of North and Central America and Europe*, pp. 115-135. Scientific Publications Office, NMFS, NOAA, Seattle, USA.
- Duarte CM, Agusti S, Barbier E, Britten GL, Castilla JC, Gattuso JP, Fulweiler RW, Hughes TP, Knowlton N, Lovelock CE, Lotze HK, Predragovic M, Poloczanska E, Roberts C, Worm B (2020) Rebuilding marine life. *Nature* 580, 39-51. <https://doi.org/10.1038/s41586-020-2146-7>
- Erdmann W (1935) Untersuchungen über die Lebensgeschichte der Auster. Nr. 5. Über die Entwicklung und die Anatomie der ansatzreifen Larve von *Ostrea edulis* mit Bemerkungen über die Lebensgeschichte der Auster [Studies on the life history of the oyster. On the development and Anatomy of the approach-mature larva of *Ostrea edulis* with comments about the life history of the oyster]. *Wissenschaftliche Meeresuntersuchungen. Abt. Helgoland* XIX, 1-33. <https://doi.org/10.1093/icesjms/11.3.381>
- Farber SC, Costanza R, Wilson MA (2002) Economic and ecological concepts for valuing ecosystem services. *Ecological Economics* 41, 375-92. [https://doi.org/10.1016/S0921-8009\(02\)00088-5](https://doi.org/10.1016/S0921-8009(02)00088-5)
- Funes VG, Jiménez RA (1989) Histological identification of the gonadal phases of the European oyster (*Ostrea edulis*), introduced experimentally into the Northwestern Coast of Baja California, Mexico. *Ciencias Marinas* 15, 41-54. <https://doi.org/10.7773/cm.v15i2.636>
- Gann GD, McDonald T, Walder B, Aronson J, Nelson CR, Jonson J, Hallett JG, Eisenberg C, Guariguata MR, Liu J, Hua F, Echeverría C, Gonzales E, Shaw N, Decler K, Dixon KW (2019) International principles and standards for the practice of ecological restoration. Second edition. *Restoration Ecology* 27, 1-46. <https://doi.org/10.1111/rec.13035>

- Gercken J, Schmidt A (2014) Current status of the European oyster (*Ostrea edulis*) and possibilities for restoration in the German North Sea. (ed.) *BfN Skripten* 379, pp. 1-96. Federal Agency for Nature Conservation, Germany.
- Gillies C, Crawford C, Hancock B (2017) Restoring Angasi oyster reefs: what is the endpoint ecosystem we are aiming for and how do we get there? *Ecological Management & Restoration* 18, 214-222. <https://doi.org/10.1111/emr.12278>
- Goelz T (2017) A Literature review of alternative substrate options for oyster restoration. (ed.) NOAA Chesapeake Bay Office: Document, pp. 1-25. NOAA Chesapeake Bay Office, Annapolis, USA.
- González-Araya R (2012) Incidence de la nutrition sur la reproduction et le développement larvaire d'*Ostrea edulis* [Impact of nutrition on reproduction and larval development of *Ostrea edulis*], Publisher, PhD/Dr Thesis. University of Brest, France.
- Grabowski JH, Brumbaugh RD, Conrad RF, Keeler AG, Opaluch JJ, Peterson CH, Piehler MF, Powers SP, Smyth AR (2012) Economic valuation of ecosystem services provided by oyster reefs. *Bioscience* 62, 900-909. <https://doi.org/10.1525/bio.2012.62.10.10>
- Grabowski JH, Peterson CH (2007) Restoring oyster reefs to recover ecosystem services. In: Cuddington K, Byers JE, Wilson WG, Hastings A (ed.) *Theoretical Ecology Series*, pp. 281-298. Academic Press
- Gutiérrez JL, Jones CG, Strayer DL, Iribarne OO (2003) Mollusks as ecosystem engineers: the role of shell production in aquatic habitats. *Oikos* 101, 79-90. <https://doi.org/10.1034/j.1600-0706.2003.12322.x>
- Haelters J, Kerckhof F (2009) Background document for *Ostrea edulis* and *Ostrea edulis* beds. (ed.) OSPAR Commission - Biodiversity Series, pp. 1-22, London, UK.
- Hassan MM, Qin JG, Li XX (2017) Gametogenesis, sex ratio and energy metabolism in *Ostrea angasi*: implications for the reproductive strategy of spermcasting marine bivalves. *Journal of molluscan studies* 84, 1-8. <https://doi.org/10.1093/mollus/eyx041>
- Héral M (1990) Traditional oyster culture in France. In: Barnabé G, de IB Solbe JF (ed.) *Aquaculture*, pp. 342-387. Ellis Horwood, Chichester, UK.
- Herman A (1937) La reproduction des huîtres indigènes dans le Morbihan et le Finistère en 1936 [Reproduction of indigenous oysters in Morbihan and Finistère in 1936]. *Revue des Travaux de l'Institut des Pêches Maritimes* 10, 61-66.
- Ivanov AI (1964) Размножение, рост и распределение черноморских устриц [Breeding, growth and distribution of Black Sea oysters]. (ed.) *Sbornik Nauchno-Tekhnicheskoy Informatsii VNIRO* 3, pp. 3-13. Russian Research Institute of Fisheries and Oceanography, Moscow, Russia.
- Jacobs P, Greeve Y, Sikkema M, Dubbeldam M, Philippart CJM (2020) Successful rearing of *Ostrea edulis* from parents originating from the Wadden Sea, the Netherlands. *Aquaculture Reports* 18, 100537. <https://doi.org/10.1016/j.aqrep.2020.100537>
- Jones CG, Lawton JH, Shachak M (1994) Organisms as ecosystem engineers. *Oikos* 69, 373-386. <https://doi.org/10.2307/3545850>
- Jovic M, Mandic M, Šljivic-Ivanovic M, Smiciklas I (2019) Recent trends in application of shell waste from mariculture. *Studia Marina* 32, 47-62. <https://doi.org/10.5281/zenodo.3274471>
- Kamermans P, Blanco A, van Dalen P, Peene F, Engelsma M (submitted) Non-destructive *Bonamia* screening for hatchery production of *Bonamia*-free flat oysters (*Ostrea edulis* L.). *Aquaculture*.
- Kamphausen L, Jensen A, Hawkins L (2011) Unusually high proportion of males in a collapsing population of commercially fished oysters (*Ostrea edulis*) in the Solent, United Kingdom. *Journal of Shellfish Research* 30, 217-222. <https://doi.org/10.2983/035.030.0204>
- Kasoar T, zu Ermgassen PSE, Carranza A, Hancock B, Spalding M (2015) New opportunities for conservation of a threatened biogenic habitat: a worldwide assessment of knowledge on bivalve-reef representation in marine and coastal Ramsar Sites. *Marine and freshwater research* 66, 981-988. <https://doi.org/10.1071/MF14306>
- Kennedy RJ, Roberts D (1999) A survey of the current status of the flat oyster *Ostrea edulis* in Strangford Lough, Northern Ireland, with a view to the restoration of its oyster beds. *Biology and Environment: Proceedings of the Royal Irish Academy* 99B(2), 79-88.

- Lallias D, Boudry P, Lapègue S, King JW, Beaumont AR (2010) Strategies for the retention of high genetic variability in European flat oyster (*Ostrea edulis*) restoration programmes. *Conservation Genetics* 11, 1899-1910. <https://doi.org/10.1007/s10592-010-0081-0>
- Larronde-Larretche M (2013) Yerseke : une éclosérie produit des huîtres plates [Yerseke: a hatchery produces flat oysters]. In: *Cultures Marines*, pp. 12.
- Lee H, Ian D, Baxter J, Diele K, Sanderson W (2020) Missing the full story: first estimates of carbon deposition rates for the European flat oyster, *Ostrea edulis*. *Aquatic Conservation: Marine and Freshwater Ecosystems* 30, 2076–2086. <https://doi.org/10.1002/aqc.3402>
- Luckenbach MW, Coen LD, Ross PGJR, Stephen JA (2005) Oyster reef habitat restoration: relationships between oyster abundance and community development based on two studies in Virginia and South Carolina. *Journal of Coastal Research Special Issue* 40, 64-78.
- Maathuis MAM, Coolen JWP, van der Have T, Kamermans P (2019) Factors determining the timing of swarming of European flat oyster (*Ostrea edulis* L.) larvae in the Dutch Delta area: implications for flat oyster restoration. *Journal of Sea Research* 156, 101828. <https://doi.org/10.1016/j.seares.2019.101828>
- McAfee D, Larkin C, Connell SD (2021) Multi-species restoration accelerates recovery of extinguished oyster reefs. *Journal of Applied Ecology* 58, 286-94. <https://doi.org/10.1111/1365-2664.13719>
- Mardones-Toledo DA, Montory JA, Joyce A, Thompson RJ, Diederich CM, Pechenik JA, Mardones ML, Chaparro OR (2015) Brooding in the Chilean oyster *Ostrea chilensis*: unexpected complexity in the movements of brooded offspring within the mantle cavity. *PloS one* 10, 1-18. <https://doi.org/10.1371/journal.pone.0122859>
- Marteil L (1976) La conchyliculture française. Partie 2 : biologie de l'huître et de la moule [Shellfish culture in France. Part 2: oyster and mussel biology]. *Revue des Travaux de l'Institut des Pêches Maritimes* 40, 149-346.
- Martin AG, Littaye-Mariette A, Langlade A, Allenou JP (1997) Cycle de reproduction naturelle de l'huître plate *Ostrea edulis* [Natural reproductive cycle of the flat oyster *Ostrea edulis*]. In: Devauchelle N, Barret J, Salaun G (ed.) *The Natural and Controlled Reproduction of Cultivated Bivalves in France: Symposium Report*, pp. 21-33. IFREMER, Nantes, France.
- Merk V, Colsoul B, Pogoda B (2020) Return of the native: survival, growth and condition of European oysters reintroduced to German offshore waters. *Aquatic Conservation: Marine and Freshwater Ecosystems* 30, 2180–2190. <https://doi.org/10.1002/aqc.3426>
- Millenium Ecosystem Assessment (2005): Ecosystems and human well-being: synthesis. Island Press. Washington, DC: 137 S.
- Olsen OT (1883) The piscatorial atlas of the North Sea, English and St. George's Channels. (ed) London: Taylor and Francis.
- Peterson BJ, Heck KL (1999) The potential for suspension feeding bivalves to increase seagrass productivity. *Journal of experimental marine Biology and Ecology* 240, 37-52. [https://dx.doi.org/10.1016/S0022-0981\(99\)00040-4](https://dx.doi.org/10.1016/S0022-0981(99)00040-4)
- Preston J, Gamble C, Debney A, Helmer L, Hancock B, zu Ermgassen P (2020) *European Native Oyster Habitat Restoration Handbook: UK & Ireland*, The Zoological Society of London, London, UK.
- Pogoda B (2012) Farming the high seas: biological performance of the offshore cultivated oysters *Ostrea edulis* and *Crassostrea gigas* in the North Sea, Publisher, PhD/Dr Thesis. University of Bremen, Germany.
- Pogoda B (2019) Current status of European oyster decline and restoration in Germany. *Humanities* 8, 9. <https://doi.org/10.3390/h8010009>
- Pogoda B, Boudry P, Bromley C, Cameron TC, Colsoul B, Donnan D, Hancock B, Hugh-Jones T, Preston J, Sanderson W, Sas H, Brown J, Bonacic K, von Nordheim H, zu Ermgassen P (2020a) NORA moving forward: developing an oyster restoration network in Europe to support the Berlin Oyster Recommendation. *Aquatic Conservation: Marine and Freshwater Ecosystems* 30, 2031–2037. <https://doi.org/10.1002/aqc.3447>
- Pogoda B, Brown J, Hancock B, Preston J, Pouvreau S, Kamermans P, Sanderson W, von Nordheim H (2019) The Native Oyster Restoration Alliance (NORA) and the Berlin Oyster

- Recommendation: bringing back a key ecosystem engineer by developing and supporting best practice in Europe. *Aquatic Living Resources* 32, 13. <https://doi.org/10.1051/alr/2019012>
- Pogoda B, Brown J, Hancock B, von Nordheim H (2017) Berlin Oyster Recommendation on the future of native oyster restoration in Europe. Part I: preface and recommendations. (ed.) *Proceedings of the 1st Native Oyster Restoration Alliance*, pp. 1-6, Berlin, Germany.
- Pogoda B, Colsoul B, Hausen T, Merk V, Peter C (2020b) Wiederherstellung der Bestände der Europäischen Auster (*Ostrea edulis*) in der deutschen Nordsee [Restoration of European oyster (*Ostrea edulis*) stocks in the German North Sea]. (ed.) *BfN Skripten 582*, pp. 1-79. Federal Agency for Nature Conservation, Germany.
- Pogoda B, Merk V, Colsoul B, Hausen T, Peter C, Pesch R, Kramer M, Jaklin S, Holler P, Bartholomä A, Michaelis R, Prinz K (2020c) Site selection for biogenic reef restoration in offshore environments: the Natura 2000 area Borkum Reefground as a case study for native oyster restoration. *Aquatic Conservation: Marine and Freshwater Ecosystems* 30, 2163–2179. <https://doi.org/10.1002/aqc.3405>
- Pogoda B, Peter C, von Nordheim H (2021) Reintroduction and ecological importance of the European oyster in the German North Sea. *Natur und Landschaft* 96, 83-88. <https://doi.org/10.17433/2.2021.50153881.83-88>
- Potet M, Fabien A, Chaudemanche S, Sebaibi N, Guillet T, Gachelin S, Cochet H, Boutouil M, Pouvreau S (2021) Which concrete substrate suits you? *Ostrea edulis* larval preferences and implications for shellfish restoration in Europe. *Ecological Engineering* 162, 106159. <https://doi.org/10.1016/j.ecoleng.2021.106159>
- Pouvreau S (2017) Underwater images of the last native oysters beds in Brittany (France). IFREMER French Research Institute for Exploitation of the Sea.
- Pouvreau S, Cochet H, Fabien A, Arzul I, Lapègue S, Gachelin S, Salaun B (2021) Inventaire, diagnostic écologique et restauration des principaux bancs d'huîtres plates en Bretagne : le projet FOREVER - Rapport final [Inventory, ecological diagnosis and restoration of the main flat oyster beds in Brittany: the FOREVER project - final report]. (ed.) *IFREMER Report: Contrat FEAMP 17/2215675*, pp. 1-122. French Research Institute for Exploitation of the Sea, France.
- Sander L, Hass HC, Michaelis R, Groß C, Hausen T, Pogoda B (2021) The late Holocene demise of a sublittoral oyster bed in the North Sea. *PloS One* 16, e0242208. <https://doi.org/10.1371/journal.pone.0242208>
- Smaal AC, Ferreira JG, Grant JG, Petersen JK, Strand Ø (2019) *Goods and Services of Marine Bivalves*, Springer Open, Clifton Park, USA. <https://doi.org/10.1007/978-3-319-96776-9>
- Strand Ø, Vølstad JH (1997) The molluscan fisheries and culture of Norway. In: MacKenzie CL, Burrell VG, Rosenfield A, Hobart WL (ed.) *The History, Present Condition, and Future of the Molluscan Fisheries of North and Central America and Europe*, pp. 7-24. Scientific Publications Office, NMFS, NOAA, Seattle, USA.
- Suquet M, Pouvreau S, Queau I, Boulais M, Le Grand J, Ratiskol D, Cosson J (2018) Biological characteristics of sperm in European flat oyster (*Ostrea edulis*). *Aquatic Living Resources* 31, 1-7. <https://doi.org/10.1051/alr/2018008>
- Tansley AG (1935) The use and abuse of vegetational concepts and terms. *Ecology* 16, 284-307. <https://doi.org/10.2307/1930070>
- Tett P, Gowen RJ, Painting SJ, Elliott M, Forster R, Mills DK, Bresnan E, Capuzzo E, Fernandes TF, Foden J, Geider RJ, Gilpin LC, Huxham M, McQuatters-Gollop AL, Malcolm SJ, Saux-Picart S, Platt T, Racault MF, Sathyendranath S, van der Molen J, Wilkinson M (2013) Framework for understanding marine ecosystem health. *Marine Ecology Progress Series* 494, 1-27. <https://doi.org/10.3354/meps10539>
- Thomas S, Collins K, Hauton C, Jensen A (2022) A review of the ecosystem services provided by the native oyster (*Ostrea edulis*): implications for restoration. *IOP Conference Series: Materials Science and Engineering* 1245, 012010. <https://doi.org/10.1088/1757-899x/1245/1/012010>
- Todorova V, Micu D, Klisurov L (2009) Unique oyster reefs discovered in the Bulgarian Black Sea. *Proceedings of the Bulgarian Academy of Sciences* 62, 871-874.

- Toepfer G (2011) Biozönose. In *Historisches Wörterbuch Der Biologie: Geschichte Und Theorie Der Biologischen Grundbegriffe*. Band 1: Analogie, Ganzheit. (ed) Georg Toepfer. Stuttgart: J.B. Metzler, 2011. [https://doi.org/10.1007/978-3-476-00439-0\\_16](https://doi.org/10.1007/978-3-476-00439-0_16)
- Vallauri DR, Aronson J, Barbero M (2002) An analysis of forest restoration 120 years after reforestation on Badlands in the Southwestern Alps. *Restoration Ecology* 10, 16-26. <https://doi.org/10.1046/j.1526-100X.2002.10102.x>
- Vera M, Carlsson J, Carlsson JEL, Cross T, Lynch S, Kamermans P, Villalba A, Culloty S, Martinez P (2016) Current genetic status, temporal stability and structure of the remnant wild European flat oyster populations: conservation and restoring implications. *Marine Biology* 163, 1-17. <https://doi.org/10.1007/s00227-016-3012-x>
- von Gersdorff Jørgensen L, Wedel Nielsen J, Kehler Villadsen M, Vismann B, Dalvin S, Mathiessen H, Madsen L, Kania PW, Buchmann K (2020) A non-lethal method for detection of *Bonamia ostreae* in flat oyster (*Ostrea edulis*) using environmental DNA. *Scientific Reports* 10, 16143. <https://doi.org/10.1038/s41598-020-72715-y>
- von Nordheim H (2018) Marine Protected Areas: global framework, regional MPA networks and a national example. In: Salomon M, Markus T (ed.) *Handbook on Marine Environment Protection : Science, Impacts and Sustainable Management*, pp. 871-890. Springer International Publishing, Cham.
- Voultsiadou E, Koutsoubas D, Achparaki M (2010) Bivalve mollusc exploitation in Mediterranean coastal communities: an historical approach. *Journal of Biological Research-Thessaloniki* 13, 35-45.
- Westby S, Geselbracht L, Pogoda B (2019) Shellfish reef restoration in practice. In: Fitzsimons L, Branigan S, Brumbaugh RD, McDonald T, zu Ermgassen PSE (ed.) *Restoration Guidelines for Shellfish Reefs*, pp. 36-48. The Nature Conservancy, Arlington, USA.
- Yonge CM (1926) Structure and physiology of the organs of feeding and digestion in *Ostrea edulis*. *Journal of the Marine Biological Association of the United Kingdom* 14, 295-386. <https://doi.org/10.1017/S002531540000789X>
- zu Ermgassen P, Bonacic K, Boudry P, Bromley CA, Cameron TC, Colsoul B, Coolen JWP, Frankić A, Hancock B, van der Have TM, Holbrook Z, Kamermans P, Laugen AT, Nevejan N, Pogoda B, Pouvreau S, Preston J, Ranger CJ, Sanderson WG, Sas H, Strand Å, Sutherland WJ (2020a) Forty questions of importance to the policy and practice of native oyster reef restoration in Europe. *Aquatic Conservation: Marine and Freshwater Ecosystems* 30, 2038–2049. <https://doi.org/10.1002/aqc.3462>
- zu Ermgassen P, Gamble C, Debney A, Colsoul B, Fabra M, Sanderson WG, Strand Å, Preston J (2020b) *European Guidelines on Biosecurity in Native Oyster Restoration*, The Zoological Society of London, London, UK.
- zu Ermgassen P, Thurstan R, Corrales J, Alleway H, Carranza A, Dankers N, DeAngelis B, Hancock B, Kent F, McLeod I, Pogoda B, Liu Q, Sanderson W (2020b) The benefits of bivalve reef restoration: a global synthesis of underrepresented species. *Aquatic Conservation: Marine and Freshwater Ecosystems* 30, 2050–2065. <https://doi.org/10.1002/aqc.3410>

Personal communication:

Hélène Cochet, Cochet Environnement EI, Le Coëdo, 56550 Locoal-Mendon, France





# Appendices



## Appendix I

Supporting Information of:

B. Colsoul, P. Boudry, M.L. Pérez-Parallé, A. Bratoš Cetinić, T. Hugh-Jones, I. Arzul, N. Mérour, K.M. Wegner, C. Peter, V. Merk, B. Pogoda

**Sustainable large-scale production of European flat oyster (*Ostrea edulis*) seed for ecological restoration and aquaculture: A review**

*Reviews in Aquaculture* 13: 1423-1468 (2021)

## Appendix S1

## Detailed methods for data search

Google Scholar: with the exact phrase "keyword", in the title of the article, search articles in any language, patents excluded, citations excluded. The following keywords have been independently and extensively sought: *Ostrea edulis*, European flat oyster, and European oyster. The following keywords were crossed in pairs: *Ostrea edulis*, European flat oyster, European oyster with Oyster ponds, Oyster polls, Spat collection, Collectors, Hatchery, Mesocosms, Remote setting, Breeding: "Ostrea edulis" AND "Oyster ponds" OR "Ostrea edulis" AND "Oyster polls" OR "Ostrea edulis" AND "Spat collection" OR "Ostrea edulis" AND "Collectors" OR "Ostrea edulis" AND "Hatchery" OR "Ostrea edulis" AND "Mesocosms" OR "Ostrea edulis" AND "Remote setting" OR "Ostrea edulis" AND "Breeding" OR "European flat oyster" AND "Oyster ponds" OR "European flat oyster" AND "Oyster polls" OR "European flat oyster" AND "Spat collection" OR "European flat oyster" AND "Collectors" OR "European flat oyster" AND "Hatchery" OR "European flat oyster" AND "Mesocosms" OR "European flat oyster" AND "Remote setting" OR "European flat oyster" AND "Breeding" OR "European oyster" AND "Oyster ponds" OR "European oyster" AND "Oyster polls" OR "European oyster" AND "Spat collection" OR "European oyster" AND "Collectors" OR "European oyster" AND "Hatchery" OR "European oyster" AND "Mesocosms" OR "European oyster" AND "Remote setting" OR "European oyster" AND "Breeding".

ISI Web of Science: basic search of "keyword", all years, all databases (Web of Science Core Collection; KCI-Korean Journal Database, Russian Science Citation Index; SciELO Citation Index), search field 1 topic (title). The search process and keywords were the same as for Scholar Google.

Scopus Document Search: advanced search, limit to English language, all sources type (journals, books, book series, conference proceedings), search in the title, abstracts, or keywords (TITLE-ABS-KEY ("keyword")). The search process and keywords were the same as for Scholar Google.

Google Scholar: all languages, all document types, anywhere in the article exact phrase "keyword"; ISI Web of Science: all languages, all document types, anywhere in the article; Scopus Document Search: all fields, exact phrase "keyword".

## Appendix S2

## List of the 602 publications selected and analysed (Update 12.2019)

- Aaraas R, Hernar IJ, Vorre A, Bergslien H, Lunestad BT, Skeie S, Slinde E, Mortensen S (2004) Sensory, histological, and bacteriological changes in flat oysters, *Ostrea edulis* L., during different storage conditions. *Journal of Food Science* 69: 205-210.
- Aase H, Misund OA, Pedersen T (1986) Predation of oyster larvae by *Aurelia aurita* in a Norwegian oyster pond. *ICES CM Document F:21*, pp. 1-16. International Council for the Exploration of the Sea, Copenhagen, Denmark.
- Abollo E, Ramilo A, Casas SM, Comesaña P, Cao A, Carballal MJ, Villalba A (2008) First detection of the protozoan parasite *Bonamia exitiosa* (Haplosporidia) infecting flat oyster *Ostrea edulis* grown in European waters. *Aquaculture* 274: 201-207.
- Acarli S (2011) Comparison of *Isochrysis galbana* and *Chlorella* sp. microalgae on growth and survival rate of European flat oyster (*Ostrea edulis*, Linnaeus 1758) larvae. *Indian Journal of Geo-Marine Sciences* 40: 55-58.
- Acarli S, Lok A (2009) Larvae development stages of the European flat oyster (*Ostrea edulis*). *Israeli Journal of Aquaculture-Bamidgeh* 61: 114-120.
- Agius C, Jaccarini V, Ritz DA (1978) Growth trials of *Crassostrea gigas* and *Ostrea edulis* in inshore waters of Malta (Central Mediterranean). *Aquaculture* 15: 195-218.
- Aguado-Giménez F, Hernández MD, Cerezo-Valverde J, Piedecausa MA, García-García B (2014) Does flat oyster (*Ostrea edulis*) rearing improve under open-sea integrated multi-trophic conditions? *Aquaculture International* 22: 447-467.

- Alagaraswami K (1982) Review on controlled breeding of bivalves of aquaculture importance. In: Subramoniam T, Varadarajan S (ed.) *Progress in Invertebrate Reproduction and Aquaculture: Proceedings of the 1st All-India Symposium on Invertebrate Reproduction*, pp. 194-202. Indian Society of Invertebrate Reproduction, Madras, India.
- Alban F, Boncoeur J (2008) Sea-ranching in the Bay of Brest (France): technical change and institutional adaptation of a scallop fishery. In: Townsend R (ed.) *Case Studies in Fisheries Self Governance*, pp. 41-51. Food and Agriculture Organization of the United Nations, Rome, Italy.
- Alderman DJ, Jones EBG (1967) Shell disease of *Ostrea edulis* L. *Nature* 216: 797-798.
- Allison EH, Badjeck MC, Meinhold K (2011) The implications of global climate change for molluscan aquaculture. In: Shumway SE (ed.) *Shellfish Aquaculture and the Environment*, pp. 461-490. John Wiley & Sons, Inc., Oxford, UK.
- Alpbaz A, Temelli B (1997) A review of the molluscan fisheries of Turkey. In: MacKenzie CL, Burrell VG, Rosenfield A, Hobart WL (ed.) *The History, Present Condition, and Future of the Molluscan Fisheries of North and Central America and Europe*, pp. 227-232. Scientific Publications Office, NMFS, NOAA, Seattle, USA.
- Alvarez G, Zapata C, Amaro R, Guerra A (1989) Multilocus heterozygosity at protein loci and fitness in the European oyster, *Ostrea edulis* L. *Heredity* 63: 359.
- Alzieu C, Thibaud Y, Heral M, Boutier B (1980) Evaluation des risques dus à l'emploi des peintures anti-salissures dans les zones conchylicoles [Estimation of the dangers caused by the use of antifouling paints in the growing oyster areas]. *Revue des Travaux de l'Institut des Pêches Maritimes* 44: 305-348.
- Amara I, Miled W, Slama RB, Ladhari N (2018) Antifouling processes and toxicity effects of antifouling paints on marine environment. A review. *Environmental Toxicology and Pharmacology* 57: 115-130.
- Andersen S, Burnell G, Bergh Ø (2000) Flow-through systems for culturing great scallop larvae. *Aquaculture International* 8: 249-257.
- Andersen S, Naas KE (1993) Shell growth and survival of scallop (*Pecten maximus* L.) in a fertilized, shallow seawater pond. *Aquaculture* 110: 71-86.
- Andrews AC (1948) Oysters as a food in Greece and Rome. *The Classical Journal* 43: 299-303.
- Anonymous (1989) Relance de l'huître plate : Rapport d'avancement des travaux 1988 [Revival program for the flat oyster *Ostrea edulis*: Review 1988]. (ed.) *IFREMER Report DRV-89.005-RA*, pp. 1-112. French Research Institute for Exploitation of the Sea, La Trinité sur Mer/La Tremblade, France.
- Anonymous (2014) Programme d'expérimentation et de recherche sur l'huître plate *Ostrea edulis*. Rapport final de l'ensemble du projet 2011-2014 [Program of experimentation and research on the flat oyster *Ostrea edulis*. Final Report 2011-2014]. (ed.) *PERLE*, pp. 1-207. Comité Régional Conchyliculture Bretagne Nord, Morlaix, France.
- Appukuttan KK, Muthiah P (1996) Technology of edible oyster culture. In: Rengarajan K (ed.) *Artificial Reefs and Seafarming Technologies*, pp. 64-69. Central Marine Fisheries Research Institute, Cochin, India.
- Arakawa KY (1980) On alien immigration of marine sessile invertebrates into Japanese waters. *Marine Fouling* 2: 29-37.
- Aranguren R, Figueras A (2016) Moving from histopathology to molecular tools in the diagnosis of molluscs diseases of concern under EU legislation. *Frontiers in Physiology* 7, 1-10.
- Arzul I, Gagnaire B, Bond C, Chollet B, Morga B, Ferrand S, Robert M, Renault T (2009) Effects of temperature and salinity on the survival of *Bonamia ostreae*, a parasite infecting flat oysters *Ostrea edulis*. *Diseases of Aquatic Organisms* 85: 67-75.
- Arzul I, Langlade A, Chollet B, Robert M, Ferrand S, Omnes E, Lerond S, Couraleau Y, Joly JP, François C, Garcia C (2011) Can the protozoan parasite *Bonamia ostreae* infect larvae of flat oysters *Ostrea edulis*? *Veterinary Parasitology* 179: 69-76.
- Asmani K, Petton B, Le Grand J, Mounier J, Robert R, Nicolas JL (2016) Establishment of microbiota in larval culture of Pacific oyster, *Crassostrea gigas*. *Aquaculture* 464: 434-444.
- Asmani K, Petton B, Le Grand J, Mounier J, Robert R, Nicolas JL (2017) Determination of stocking density limits for *Crassostrea gigas* larvae reared in flow-through and recirculating aquaculture systems and interaction between larval density and biofilm formation. *Aquatic Living Resources* 30: 1-13.
- Auby I, Maurer D (2004) Etude de la reproduction de l'huître creuse dans le Bassin d'Arcachon [Study of the reproduction of oysters in the Arcachon Basin]. (ed.) *IFREMER Report R.INT.DEL/AR 04-05*, pp. 1-203. French Research Institute for Exploitation of the Sea, Arcachon, France.

- Azevedo C, Montes J, Corral L (1999) A revised description of *Haplosporidium armoricanum*, parasite of *Ostrea edulis* L. from Galicia, northwestern Spain, with special reference to the spore-wall filaments. *Parasitology Research* 85: 977-983.
- Bamford DR, Gingles R (1974) Absorption of sugars in the gill of the Japanese oyster, *Crassostrea gigas*. *Comparative Biochemistry and Physiology* 49A: 637-646.
- Bará S, Pérez-Parallé ML, Sánchez JL, Lima RC, Cegarra X, Bouzas JAF (2018) Light pollution in shallow coastal waters: aquaculture farming in the Galician Atlantic shoreline. *arXiv preprint arXiv:1805.07227*.
- Barre M, Naciri Y, Boudry P, Goyard E, Launey S, Cochennec N, Heurtebise S, Ledu C, Phelipot P, Gerard A (1997) Historique, expériences en cours et perspectives du programme de sélection de l'huître plate *Ostrea edulis* pour la résistance à la bonamiose [History, experiences underway and prospects of the breeding program of the flat oyster *Ostrea edulis* for the resistance to the bonamiosis]. (ed.) *IFREMER Journées Conchylicoles 1997*, pp. 1-1. French Research Institute for Exploitation of the Sea, Nantes, France.
- Barthélemy-Saint Hilaire J (1887) *Traité de la Génération des Animaux, Volume 1, Oeuvres d'Aristote*, Hachette et Cie, Paris, France.
- Battaler E, Burke K, Ouellette M, Maillet MJ (2006) Evaluation of spawning period and spat collection of the northernmost population of European oysters (*Ostrea edulis* L.) on the Canadian Atlantic coast. (ed.) *Canadian Technical Report of Fisheries and Aquatic Sciences* 2630, pp. 1-34. Department of Fisheries and Oceans, Canada.
- Baud JP, Gérard A, Naciri-Graven Y (1997) Comparative growth and mortality of *Bonamia ostreae*-resistant and wild flat oysters, *Ostrea edulis*, in an intensive system. I. First year of experiment. *Marine Biology* 130: 71-79.
- Baud JP, Jolly C, Bodoy A (1991) Improvement of remote setting of the Pacific oyster (*Crassostrea gigas*) on French plastic pipes. *ICES CM Document K:29*, pp. 1-12. International Council for the Exploration of the Sea, Copenhagen, Denmark.
- Bayne BL (1969) The gregarious behaviour of the larvae of *Ostrea edulis* L. at settlement. *Journal of the Marine Biological Association of the United Kingdom* 49: 327-356.
- Bayne BL (2017) *Biology of Oysters. Developments in Aquaculture and Fisheries Science Volume 41*, Elsevier Science, Academic Press, London, UK.
- Beaulieu M (1890) Letter on oyster culture. *Journal of the Marine Biological Association of the United Kingdom* 1: 282-285.
- Beaumont A, Garcia MT, Hönig S, Low P (2006) Genetics of Scottish populations of the native oyster, *Ostrea edulis*: gene flow, human intervention and conservation. *Aquatic Living Resources* 19: 389-402.
- Beck MW, Brumbaugh RD, Airoidi L, Carranza A, Coen LD, Crawford C, Defeo O, Edgar GJ, Hancock B, Kay MC, Lenihan HS, Luckenbach MW, Toropova CL, Zhang G, Guo X (2011) Oyster reefs at risk and recommendations for conservation, restoration, and management. *Bioscience* 61: 107-116.
- Beiras R, Camacho AP (1994) Influence of food concentration on the physiological energetics and growth of *Ostrea edulis* larvae. *Marine Biology* 120: 427-435.
- Beiras R, Camacho AP, Albertosa M (1994) Comparison of the scope for growth with the growth performance of *Ostrea edulis* seed reared at different food concentrations in an open-flow system. *Marine Biology* 119: 227-233.
- Bell JD, Clua E, Hair CA, Galzin R, Doherty PJ (2009) The capture and culture of post-larval fish and invertebrates for the marine ornamental trade. *Reviews in Fisheries Science* 17: 223-240.
- Benovic A (1997) The history, present condition, and future of the molluscan fisheries of Croatia. In: MacKenzie CL, Burrell VG, Rosenfield A, Hobart WL (ed.) *The History, Present Condition, and Future of the Molluscan Fisheries of North and Central America and Europe*, pp. 217-226. Scientific Publications Office, NMFS, NOAA, Seattle, USA.
- Berghahn R, Ruth M (2005) The disappearance of oysters from the Wadden Sea: a cautionary tale for no-take zones. *Aquatic Conservation: Marine and Freshwater Ecosystems* 15: 91-104.
- Berntsson KM, Jonsson PR, Wängberg SA, Carlsson AS (1997) Effects of broodstock diets on fatty acid composition, survival and growth rates in larvae of the European flat oyster, *Ostrea edulis*. *Aquaculture* 154: 139-153.
- Berthe FCJ, Le Roux F, Adlard RD, Figueras A (2004) Marteiliiosis in molluscs: a review. *Aquatic Living Resources* 17: 433-448.
- Berthome JP, Prou J, Razet D, Garnier J (1984) Première approche d'une méthode d'estimation prévisionnelle de la production potentielle d'huîtres creuses *C. gigas* d'élevage [First approach of previsual estimation of the potential production of *Crassostrea gigas*]. *Haliotis* 14: 39-48.

- Berthome JP, Razet D, Garnier J (1981) Description, évolution et importance des différentes techniques de captage en rivière Seudre (bassin de Marennes-Oléron) : incidence sur la production d'huîtres creuses *C. gigas* [Description, evolution, and importance of different collection techniques in the Seudre river (Marennes-Oléron basin) impact on the production of hollow oysters *C. gigas*]. *ICES CM Document K:30*, pp. 1-19. International Council for the Exploration of the Sea, Copenhagen, Denmark.
- Bierne N, Launey S, Naciri-Graven Y, Bonhomme F (1998) Early effect of inbreeding as revealed by microsatellite analyses on *Ostrea edulis* larvae. *Genetics* 148: 1893-1906.
- Blanc F, Pichot P, Attard J (1986) Genetic variability in the European oyster, *Ostrea edulis*: geographic variation between local French stocks. *Aquaculture* 57: 362-363.
- Blogoslawski WJ, Stewart ME, Rhodes EW (1978) Bacterial disinfection in shellfish hatchery disease control. *Proceedings of the Annual Meeting - World Mariculture Society* 9: 587-602.
- Bodoy A, Bougrier S, Geairon P, Garnier J, Boulo V, Heurtebise S (1991) Does the prevalence of Bonamia and Marteilia diseases be reduced on flat oysters (*Ostrea edulis*) of Atlantic and Mediterranean origin, when they are reared together with the Japanese oyster (*Crassostrea gigas*) in tidal ponds? *ICES CM Document K:28*, pp. 1-10. International Council for the Exploration of the Sea, Copenhagen, Denmark.
- Boeuf G (2000) Present status of the French aquaculture. *Aquaculture Science* 48: 243-248.
- Bøhle B (1984) Østers og østerskultur i Norge. Utnyttning av østerspoller på Skagerrakkysten [Oysters and oyster culture in Norway. Exploitation of oyster polls on the Skagerrak Coast]. (ed.) *Flødevigen Meldinger* 6, pp. 1-23. Institute of Marine Research, Arendal, Norway.
- Bøhle B (1986) Østerspoller på Skagerrakkysten. Egnethetsundersøkelser sommeren 1985 [Oyster polls on the Skagerrak Coast. Suitability surveys in the summer of 1985]. (ed.) *Flødevigen Meldinger* 4, pp. 1-69. Institute of Marine Research, Arendal, Norway.
- Bøhle B (1987) Hydrography of four sea water basins at the Skagerrak Coast 1986-1987. (ed.) *Flødevigen Meldinger* 4, pp. 1-45. Institute of Marine Research, Arendal, Norway.
- Bohn RE, Webster DW, Meritt DW (1995) Producing oyster seed by remote setting. (ed.) *NRAC Bulletin* 220, pp. 1-11. Northeastern Regional Aquaculture Center, University of Massachusetts Dartmouth, Dartmouth, USA.
- Bolinches J, Toranzo AE, Silva A, Barja JL (1986) Vibriosis as the main causative factor of heavy mortalities in the oyster culture industry in northwestern Spain. *Bulletin of the European Association of Fish Pathologists* 6: 1-4.
- Boudry P, Launey S, Diaz-Almela E, Naciri-Graven Y, Ledu C, Mira S, Taris N, Bonhomme F, Lapegue S (2002) Population genetics of the European flat oyster (*Ostrea edulis*): from larvae to populations. *ICES CM Document U:09*, pp. 1-15. International Council for the Exploration of the Sea, Copenhagen, Denmark.
- Bougrier S, Tige G, Bachere E, Grizel H (1986) *Ostrea angasi* acclimatization to French coasts. *Aquaculture* 58: 151-154.
- Boulais M, Chenevert KJ, Demey AT, Darrow ES, Robison MR, Roberts JP, Volety A (2017) Oyster reproduction is compromised by acidification experienced seasonally in coastal regions. *Scientific Reports* 7, 1-9.
- Bower SM, Hervio D, Meyer GR (1997) Infectivity of *Mikrocytos mackini*, the causative agent of Denman Island disease in Pacific oysters *Crassostrea gigas*, to various species of oysters. *Diseases of Aquatic Organisms* 29: 111-116.
- Bracke E, Polk P (1969) Contribution à la connaissance de la faune marine de la côte belge [Contribution to the knowledge of the marine fauna of the Belgian coast]. *Hydrobiologia* 34: 100-125.
- Bratoš A, Bolotin J, Peharda M, Njire J (2002) Seasonal distribution of the oyster *Ostrea edulis* (Linnaeus, 1758) larvae in the bay of Mali Ston, Adriatic Sea. *Journal of Shellfish Research* 21: 763-767.
- Brenner M, Fraser D, Van Nieuwenhove K, O'Beirn F, Buck BH, Mazurie J, Thorarinsdottir G, Dolmer P, Sanchez-Mata A, Strand O, Flimlin G, Miossec L, Kamermans P (2014) Bivalve aquaculture transfers in Atlantic Europe. Part B: Environmental impacts of transfer activities. *Ocean & Coastal Management* 89: 139-146.
- Bromley C, McGonigle C, Ashton EC, Roberts D (2016a) Bad moves: Pros and cons of moving oysters - a case study of global translocations of *Ostrea edulis* Linnaeus, 1758 (Mollusca: Bivalvia). *Ocean & Coastal Management* 122: 103-115.
- Bromley C, McGonigle C, Ashton EC, Roberts D (2016b) Restoring degraded European native oyster, *Ostrea edulis*, habitat: is there a case for harrowing? *Hydrobiologia* 768: 151-165.
- Brooks WK (1879) Abstract of observations upon the artificial fertilization of oyster eggs, and on the embryology of the American oyster. *American Journal of Science* 18: 425-427.



- Brown C (1981) Bacterial diseases in bivalve larval cultures and their control. *ICES CM Document K:32*, pp. 1-22. International Council for the Exploration of the Sea, Copenhagen, Denmark.
- Brown MR, Barrett SM, Volkman JK, Nearhos SP, Nell JA, Allan GL (1996) Biochemical composition of new yeasts and bacteria evaluated as food for bivalve aquaculture. *Aquaculture* 143: 341-360.
- Brown MR, Blackburn SI (2013) Live microalgae as feeds in aquaculture hatcheries. In: Allan G, Burnell G (ed.) *Advances in Aquaculture Hatchery Technology*, pp. 117-158. Woodhead Publishing Limited, Cambridge, UK.
- Brown MR, Jeffrey SW, Volkman JK, Dunstan GA (1997) Nutritional properties of microalgae for mariculture. *Aquaculture* 151: 315-331.
- Bruce JR, Knight M, Parke MW (1940) The rearing of oyster larvae on an algal diet. *Journal of the Marine Biological Association of the United Kingdom* 24: 337-374.
- Buestel D, Ropert M, Prou J, Gouilletquer P (2009) History, status, and future of oyster culture in France. *Journal of Shellfish Research* 28: 813-820.
- Buitrago E, Alvarado D (2005) A highly efficient oyster spat collector made with recycled materials. *Aquacultural Engineering* 33: 63-72.
- Burke K, Bataller É, Miron G (2008a) Spat collection of a non-native bivalve species (European oyster, *Ostrea edulis*) off the eastern Canadian coast. *Journal of Shellfish Research* 27: 345-353.
- Burke K, Bataller É, Miron G, Ouellette M, Tremblay R (2008b) Larval quality of a nonnative bivalve species (European oyster, *Ostrea edulis*) off the east Canadian coast. *Journal of Shellfish Research* 27: 701-710.
- Buroker NE (1985) Evolutionary patterns in the family Ostreidae: Larviparity vs. oviparity. *Journal of Experimental Marine Biology and Ecology* 90: 233-247.
- Bushek D, Richardson D, Bobo MY, Coen LD (2004) Quarantine of oyster shell cultch reduces the abundance of *Perkinsus marinus*. *Journal of Shellfish Research* 23: 369-374.
- Caceres-Martinez J, Figueras A (1997) The mussel, oyster, clam, and pectinid fisheries of Spain. In: MacKenzie CL, Burrell VG, Rosenfield A, Hobart WL (ed.) *The History, Present Condition, and Future of the Molluscan Fisheries of North and Central America and Europe*, pp. 165-190. Scientific Publications Office, NMFS, NOAA, Seattle, USA.
- Cáceres-Martínez J, Robledo JAF, Figueras A (1995) Presence of *Bonamia* and its relation to age, growth rates and gonadal development of the flat oyster, *Ostrea edulis*, in the Ria de Vigo, Galicia (NW Spain). *Aquaculture* 130: 15-23.
- Calabrese A, Davis HC (1970) Tolerances and requirements of embryos and larvae of bivalve molluscs. *Helgoländer Wissenschaftliche Meeresuntersuchungen* 20: 553-564.
- Calabrese A, MacInnes JR, Nelson DA, Miller JE (1977) Survival and growth of bivalve larvae under heavy-metal stress. *Marine Biology* 41: 179-184.
- Cano J, Rosique MJ, Rocamora J (1997) Influence of environmental parameters on reproduction of the European flat oyster (*Ostrea edulis* L.) in a coastal lagoon (Mar Menor, southeastern Spain). *Journal of Molluscan Studies* 63: 187-196.
- Capuzzo E, Stephens D, Silva T, Barry J, Forster RM (2015) Decrease in water clarity of the southern and central North Sea during the 20th century. *Global Change Biology* 21: 2206-2214.
- Carbonnier N, Martin AG, Mazurie J, Barthelemy G, Le Mouroux G, Martin AG, Langlade A, Barthelemy G, Camus P, Lassalle E, Cochard JC, Miners P (1990) Télécaptage de l'huître plate : travaux réalisés en 1990 [Remote setting of the flat oyster: work carried out in 1990]. (ed.) *Section Régionale de Bretagne Sud : Plan de Relance de l'Huître Plate 1990*, pp. 1-97. CIC-IFREMER, Auray, France.
- Carella F, Carrasco N, Andree KB, Lacuesta B, Furones D, De Vico G (2013) Nocardiosis in Mediterranean bivalves: first detection of *Nocardia crassostreae* in a new host *Mytilus galloprovincialis* and in *Ostrea edulis* from the Gulf of Naples (Italy). *Journal of Invertebrate Pathology* 114: 324-328.
- Carlucci R, Sassanelli G, Matarrese A, Giove A, D'Onghia G (2010) Experimental data on growth, mortality and reproduction of *Ostrea edulis* (L., 1758) in a semi-enclosed basin of the Mediterranean Sea. *Aquaculture* 306: 167-176.
- Carnegie RB, Arzul I, Bushek D (2016) Managing marine mollusc diseases in the context of regional and international commerce: policy issues and emerging concerns. *Philosophical Transactions of the Royal Society B-Biological Sciences* 371: 1-11.
- Carnegie RB, Cochennec-Laureau N (2004) Microcell parasites of oysters: recent insights and future trends. *Aquatic Living Resources* 17: 519-528.
- Carpenter GH (1910) Advances in Irish marine zoology. *Irish Naturalists' Journal* 19: 74-78.
- Carrasco N, Green T, Itoh N (2015) *Marteilia* spp. parasites in bivalves: a revision of recent studies. *Journal of Invertebrate Pathology* 131: 43-57.

- Casas SM, Reece KS, Li Y, Moss JA, Villalba A, La Peyre JF (2008) Continuous culture of *Perkinsus mediterraneus*, a parasite of the European flat oyster *Ostrea edulis*, and characterization of its morphology, propagation, and extracellular proteins in vitro. *Journal of Eukaryotic Microbiology* 55: 34-43.
- Castagna M (1983) Review of recent bivalve culture methods. *Journal of the World Mariculture Society* 14: 567-575.
- Castanos C, Pascual MS, Agulleiro I, Zampatti E, Elvira M (2005) Brooding pattern and larval production in wild stocks of the puelche oyster, *Ostrea puelchana* d'Orbigny. *Journal of Shellfish Research* 24: 191-196.
- Castell JD, Trider DJ (1974) Preliminary feeding trials using artificial diets to study the nutritional requirements of oysters (*Crassostrea virginica*). *Journal of the Fisheries Board of Canada* 31: 95-99.
- Chanley MH, Chanley P (1991) Cultivation of the Chilean oyster, *Tiostrea chilensis* (Phillipi, 1845). In: Menzel W (ed.) *Estuarine and Marine Bivalve Mollusk Culture*, pp. 145-151. CRC Press Inc., Boca Raton, USA.
- Chaparro OR, Mardones-Toledo DA, Gray MW, Cubillos VM, Navarro JM, Salas-Yanquin LP (2018) Female-embryo relationships in *Ostrea chilensis*: brooding, embryo recognition, and larval hatching. *Marine Biology* 166: 10.
- Child AR, Laing I (1998) Comparative low temperature tolerance of small juvenile European, *Ostrea edulis* L., and Pacific oysters, *Crassostrea gigas* Thunberg. *Aquaculture Research* 29: 103-113.
- Chu FLE, Webb KL, Hepworth DA, Casey BB (1987) Metamorphosis of larvae of *Crassostrea virginica* fed microencapsulated diets. *Aquaculture* 64: 185-197.
- Clark JE, Langmo RD (1979) Oyster seed hatcheries on the US West Coast: an overview. *Marine Fisheries Review* 80: 10-16.
- Claus C (1981) Trends in nursery rearing of bivalve molluscs. In: Claus C, De Pauw N, Jaspers E (ed.) *Nursery Culturing of Bivalve Molluscs: Proceedings of the International Workshop on Culturing of Bivalve Molluscs*, pp. 1-33. European Mariculture Society, Bredene, Belgium.
- Claus C, Maeckelberghe H, Pauw N (1983) Onshore nursery rearing of bivalve molluscs in Belgium. *Aquacultural Engineering* 2: 13-26.
- Clewell AF, Aronson J (2013) *Ecological Restoration: Principles, Values, and Structure of an Emerging Profession*, Island Press, Washington, USA.
- Coatanea D, Oheix J, Mazzara L, Hamon PY (1992) Essais de télécaptage de l'huître plate *Ostrea edulis* en Méditerranée : Bilan 1991 [Remote setting trials of the flat oyster *Ostrea edulis* in the Mediterranean: Review 1991]. (ed.) *IFREMER Report RIDRV-92.021 RA*, pp. 1-63. French Research Institute for Exploitation of the Sea, Palavas-les-Flots, France.
- Coatanea D, Oheix J, Mazzara L, Vercelli C (1994) Élevage de l'huître plate en Languedoc-Roussillon : Bilan des travaux 1990-1992 [Breeding of the flat oyster in Languedoc-Roussillon: Review 1990-1992]. (ed.) *IFREMER Report RIDRV-94.01 RA*, pp. 1-73. French Research Institute for Exploitation of the Sea, Palavas-les-Flots, France.
- Coen LD, Luckenbach MW (2000) Developing success criteria and goals for evaluating oyster reef restoration: ecological function or resource exploitation? *Ecological Engineering* 15: 323-343.
- Cohen AN, Zabin CJ (2009) Oyster shells as vectors for exotic organisms. *Journal of Shellfish Research* 28: 163-167.
- Cole HA (1939) Further experiments in the breeding of oysters in tanks. (ed.) *Fishery Investigations Series II*, pp. 1-50. Her Majesty's Stationery Office, London, UK.
- Cole HA (1941) The fecundity of *Ostrea edulis*. *Journal of the Marine Biological Association of the United Kingdom* 25: 243-260.
- Cole HA (1942) Primary sex-phases in *Ostrea edulis*. *Journal of Cell Science* 83: 317-356.
- Cole HA, Knight Jones EW (1949) The setting behaviour of larvae of the European flat oyster *Ostrea edulis* L., and its influence on methods of cultivation and spat collection. (ed.) *Fishery Investigations Series II*, pp. 1-39. Her Majesty's Stationery Office, London, UK.
- Collyer DM (1957) Viability and glycogen reserves in the newly liberated larvae of *Ostrea edulis* L. *Journal of the Marine Biological Association of the United Kingdom* 36: 335-337.
- Comps M, Cochennec N (1993) A herpes-like virus from the European oyster *Ostrea edulis* L. *Journal of Invertebrate Pathology* 62: 201-203.
- Connellan I (1995) Shellfish hatchery design with notes on spatting ponds for aquaculture students, Publisher, Galway-Mayo Institute of Technology, Ireland.
- Connor PM (1972) Acute toxicity of heavy metals to some marine larvae. *Marine Pollution Bulletin* 3: 190-192.

- Coon SL, Bonar DB, Weiner RM (1986) Chemical production of cultchless oyster spat using epinephrine and norepinephrine. *Aquaculture* 58: 255-262.
- Corlay JP (2001) Voyage d'exploration sur le littoral de la France et de l'Italie (Victor Coste, 1861), ou Prométhée au pays d'*Ostrea* [A voyage of exploration on the coasts of France and Italy (Victor Coste, 1861), or Prometheus in the Land of *Ostrea*]. *Les Cahiers Nantais* 55: 289-307.
- Coste JMCV (1861) *Voyage d'Exploration sur le Littoral de la France et de l'Italie*, Imprimerie Impériale, Paris, France.
- Coutteau P, Caers M, Curé K, Gajardo G (1996) Supplementation of lipid emulsions to algal diets in the hatchery rearing of bivalves. In: Gajardo G, Coutteau P (ed.) *Improvement of the Commercial Production of Marine Aquaculture Species: Proceedings of a Workshop on Fish and Mollusk Larviculture*, pp. 145-154. Impresora Creces, Santiago, Chile.
- Coutteau P, Sorgeloos P (1992) The use of algal substitutes and the requirement for live algae in the hatchery and nursery rearing of bivalve molluscs: an international survey. *Journal of Shellfish Research* 11: 467-476.
- Coutteau P, Sorgeloos P (1993) The use of artificial diets in the hatchery rearing of bivalve mollusks. *Mededelingen - Faculteit Landbouwwetenschappen, Rijksuniversiteit Gent* 57: 2111-2119.
- Cragg SM, Gruffydd LLD (1975) The swimming behaviour and the pressure responses of the veliconcha larvae of *Ostrea edulis* (L.). In: Barnes HB (ed.) *Proceedings of the 9<sup>th</sup> European Marine Biology Symposium*, pp. 43-57. Aberdeen University Press, Aberdeen, UK.
- Cranfield HJ (1973a) Observations on the behaviour of the pediveliger of *Ostrea edulis* during attachment and cementing. *Marine Biology* 22: 203-209.
- Cranfield HJ (1973b) Observations on the function of the glands of the foot of the pediveliger of *Ostrea edulis* during settlement. *Marine Biology* 22: 211-223.
- Crawford C (2016) National review of *Ostrea angasi* aquaculture: historical culture, current methods and future priorities. (ed.) *Contract Report of the University of Tasmania*, pp. 1-44. Institute for Marine and Antarctic Studies, University of Tasmania, Hobart, Australia.
- Crawford DW, Hawkins LE, Hutchinson S, Antai EE, Purdie DA, Lockwood APM (1993) Red tides of *Mesodinium rubrum*: evidence for remotely imposed stress on the oyster *Ostrea edulis*. In: Smayda TJ, Shimizu Y (ed.) *Toxic Phytoplankton Blooms in the Sea: Proceedings of the 5<sup>th</sup> International Conference on Toxic Marine Phytoplankton*, pp. 389-394. Elsevier Science Publishers BV, Amsterdam, The Netherlands.
- Creswell LR (2010) Phytoplankton culture for aquaculture feed. (ed.) *SRAC Publication 5004*, pp. 1-16. Southern Regional Aquaculture Center, Stoneville, USA.
- Cross ML, Newkirk GF, Johnson G (1987) Strategies for the cultivation of European oysters (*Ostrea edulis*) in the Maritime provinces of Canada: preliminary analyses. *Canadian Journal of Fisheries and Aquatic Sciences* 44: 674-679.
- Culloty SC, Cronin MA, Mulcahy MF (2001) An investigation into the relative resistance of Irish flat oysters *Ostrea edulis* L. to the parasite *Bonamia ostreae* (Pichot et al., 1980). *Aquaculture* 199: 229-244.
- Culloty SC, Cronin MA, Mulcahy MF (2004) Potential resistance of a number of populations of the oyster *Ostrea edulis* to the parasite *Bonamia ostreae*. *Aquaculture* 237: 41-58.
- Culloty SC, Mulcahy MF (1992) An evaluation of anaesthetics for *Ostrea edulis* (L.). *Aquaculture* 107: 249-252.
- Culloty SC, Mulcahy MF (1996) Season-, age-, and sex-related variation in the prevalence of bonamiasis in flat oysters (*Ostrea edulis* L.) on the south coast of Ireland. *Aquaculture* 144: 53-63.
- Culloty SC, Mulcahy MF (2001) Living with bonamiasis: Irish research since 1987. *Hydrobiologia* 465: 181-186.
- Culloty SC, Mulcahy MF (2007) *Bonamia ostreae* in the native oyster *Ostrea edulis*. A review. (ed.) *Marine Environment and Health Series No. 29*, pp. 1-40. Marine Institute, Ireland.
- da Silva P, Renault T, Fuentes J, Villalba A (2008) Herpesvirus infection in European flat oysters *Ostrea edulis* obtained from brood stocks of various geographic origins and grown in Galicia (NW Spain). *Diseases of Aquatic Organisms* 78: 181-188.
- Dannevig A (1947) The Fløadavig sea fish hatchery, at Arendal, Norway. *ICES Journal of Marine Science* 15: 7-12.
- Dantan JL, Perrier E (1912) Le fonctionnement de la glande génitale chez l'*Ostrea edulis* (L.) et le *Gryphaea angulata* (Lam.). La protection des bancs naturels [Genital gland function in *Ostrea edulis* (L.) and *Gryphaea angulata* (Lam.). The protection of natural beds]. *Comptes Rendus Hebdomadaires des Séances de l'Académie des Sciences* 155: 324-327.
- Dantan JL, Perrier E (1913) La fécondité de l'*Ostrea edulis* (L.). [The fecundity of the *Ostrea edulis* (L.)]. *Comptes Rendus Hebdomadaires des Séances de l'Académie des Sciences* 157: 871-873.

- Dao JC, Fleury PG, Barret J (1999) Scallop sea bed culture in Europe. In: Howell BR, Moksness E, Svåsand T (ed.) *Stock Enhancement and Sea Ranching*, pp. 423-436. Fishing News Books, Blackwell Publishing, Oxford, UK.
- Davaine C (1853) *Recherches sur la Génération des Huîtres*, E. Thunot et Cie, Paris, France.
- Davenel A, González R, Suquet M, Quéllec S, Robert R (2010) Individual monitoring of gonad development in the European flat oyster *Ostrea edulis* by in vivo magnetic resonance imaging. *Aquaculture* 307: 165-169.
- Davis HC (1953) On food and feeding of larvae of the American oyster, *C. virginica*. *The Biological Bulletin* 104: 334-350.
- Davis HC, Ansell AD (1962) Survival and growth of larvae of the European oyster, *O. edulis*, at lowered salinities. *The Biological Bulletin* 122: 33-39.
- Davis HC, Calabrese A (1969) Survival and growth of larvae of the European oyster (*Ostrea edulis* L.) at different temperatures. *The Biological Bulletin* 136: 193-199.
- De Rijcke M, Van Acker E, Nevejan N, De Schampelaere KAC, Janssen CR (2016) Toxic dinoflagellates and *Vibrio* spp. act independently in bivalve larvae. *Fish & Shellfish Immunology* 57: 236-242.
- Dean B (1890) The present methods of oyster-culture in France. *Bulletin of the United States Fish Commission* 10: 363-398.
- Dean B (1891) Report on the European methods of oyster-culture. *Bulletin of the United States Fish Commission* 11: 357-406.
- Dean B (1902) Japanese oyster-culture. *Bulletin of the United States Fish Commission* 22: 17-38.
- Devauchelle N, Thielley M, Salaün G (1997) Estimation des stades de maturité de bivalves [Estimation of the maturity stages of bivalves]. In: Devauchelle N, Barret J, Salaun G (ed.) *The Natural and Controlled Reproduction of Cultivated Bivalves in France: Symposium Report*, pp. 81-90. IFREMER, Nantes, France.
- Diaz-Almela E, Boudry P, Launey S, Bonhomme F, Lapègue S (2004) Reduced female gene flow in the European flat oyster *Ostrea edulis*. *Journal of Heredity* 95: 510-516.
- Dijkema R (1997) Molluscan fisheries and culture in the Netherlands. In: MacKenzie CL, Burrell VG, Rosenfield A, Hobart WL (ed.) *The History, Present Condition, and Future of the Molluscan Fisheries of North and Central America and Europe*, pp. 115-135. Scientific Publications Office, NMFS, NOAA, Seattle, USA.
- Dodgson RW (1922) Noctiluca as an enemy of the oyster. *Nature* 110: 343-344.
- Downing SL, Allen SK (1987) Induced triploidy in the Pacific oyster, *Crassostrea gigas*: optimal treatments with cytochalasin B depend on temperature. *Aquaculture* 61: 1-15.
- Dridi S, Romdhane MS, Heurtebise S, Cafsi EM, Boudry P, Lapègue S (2008) Genetic characterisation of oyster populations along the north-eastern coast of Tunisia. *African Journal of Marine Science* 30: 489-495.
- Drinkwaard AC (1998) Introductions and developments of oysters in the North Sea area: a review. *Helgoländer Meeresuntersuchungen* 52: 301-308.
- Dubert J, Barja JL, Romalde JL (2017) New insights into pathogenic vibrios affecting bivalves in hatcheries: present and future prospects. *Frontiers in Microbiology* 8: 1-16.
- Dubert J, Romalde JL, Prado S, Barja JL (2016) *Vibrio bivalvicida* sp. nov., a novel larval pathogen for bivalve molluscs reared in a hatchery. *Systematic and Applied Microbiology* 39: 8-13.
- Dunphy BJ, Wells RMG, Jeffs AG (2005) Polydorid infestation in the flat oyster, *Tiostrea chilensis*: hyposaline treatment for an aquaculture candidate. *Aquaculture International* 13: 351-358.
- Dupuy JL, Rivkin S (1970) Cultch-free spat present and future. (ed.) *Proceedings of the Annual Workshop*, pp. 157-158. World Mariculture Society, Baton Rouge, USA.
- Dupuy JL, Rivkin S, Ott FD (1973) A new type of oyster hatchery. *Proceedings of the Annual Workshop - World Mariculture Society* 4: 353-368.
- Dupuy JL, Windsor NT, Sutton CE (1977) Manual for design and operation of an oyster seed hatchery for the American oyster *Crassostrea Virginica*. (ed.) *Special Report No. 142 in Applied Marine Science and Ocean Engineering*, pp. Virginia Institute of Marine Science, Gloucester Point, Virginia, USA.
- Eagling LE, Ashton EC, Jensen AC, Sigwart JD, Murray D, Roberts D (2018) Spatial and temporal differences in gonad development, sex ratios and reproductive output, influence the sustainability of exploited populations of the European oyster, *Ostrea edulis*. *Aquatic Conservation: Marine and Freshwater Ecosystems* 28: 1-12.
- Edwards E (1997) Molluscan fisheries in Britain. In: MacKenzie CL, Burrell VG, Rosenfield A, Hobart WL (ed.) *The History, Present Condition, and Future of the Molluscan Fisheries of North and Central America and Europe*, pp. 85-99. Scientific Publications Office, NMFS, NOAA, Seattle, USA.

- El-Gayar OF (1997) The use of information technology in aquaculture management. *Aquaculture Economics & Management* 1: 109-128.
- Elston R, Elliot EL, Colwell RR (1982) Conchiolin infection and surface coating *Vibrio*: shell fragility, growth depression and mortalities in cultured oysters and clams, *Crassostrea virginica*, *Ostrea edulis* and *Mercenaria mercenaria*. *Journal of Fish Diseases* 5: 265-284.
- Elston R, Leibovitz L, Relyea D, Zatila J (1981) Diagnosis of vibriosis in a commercial oyster hatchery epizootic: diagnostic tools and management features. *Aquaculture* 24: 53-62.
- Elston RA, Kent ML, Wilkinson MT (1987) Resistance of *Ostrea edulis* to *Bonamia ostreae* infection. *Aquaculture* 64: 237-242.
- Engelsma MY, Culloty SC, Lynch SA, Arzul I, Carnegie RB (2014) *Bonamia* parasites: a rapidly changing perspective on a genus of important mollusc pathogens. *Diseases of Aquatic Organisms* 110: 5-23.
- Engelsma MY, Roozenburg I, Joly JP (2008) First isolation of *Nocardia crassostreae* from Pacific oyster *Crassostrea gigas* in Europe. *Diseases of Aquatic Organisms* 80: 229-234.
- Enright CT, Craigie JS, Newkirk GF (1985) The effect of pH and the improvement of water quality by *Chondrus crispus* in an *Ostrea edulis* nursery. *Journal of the World Mariculture Society* 16: 386-386.
- Enright CT, Newkirk GF, Craigie JS, Castell JD (1986a) Evaluation of phytoplankton as diets for juvenile *Ostrea edulis* L. *Journal of Experimental Marine Biology and Ecology* 96: 1-13.
- Enright CT, Newkirk GF, Craigie JS, Castell JD (1986b) Growth of juvenile *Ostrea edulis* L. fed *Chaetoceros gracilis* Schütt of varied chemical composition. *Journal of Experimental Marine Biology and Ecology* 96: 15-26.
- Epifanio CE (1979) Comparison of yeast and algal diets for bivalve molluscs. *Aquaculture* 16: 187-192.
- Erdmann W (1935) Untersuchungen über die Lebensgeschichte der Auster. Nr. 5. Über die Entwicklung und die Anatomie der ansatzreifen Larve von *Ostrea edulis* mit Bemerkungen über die Lebensgeschichte der Auster [Studies on the life history of the oyster. On the development and Anatomy of the approach-mature larva of *Ostrea edulis* with comments about the life history of the oyster]. *Wissenschaftliche Meeresuntersuchungen. Abt. Helgoland* XIX: 1-33.
- Fabioux C, Huvet A, Lelong C, Robert R, Pouvreau S, Daniel JY, Minguant C, Le Pennec M (2004) Oyster *vasa*-like gene as a marker of the germline cell development in *Crassostrea gigas*. *Biochemical and Biophysical Research Communications* 320: 592-598.
- Fábregas J, Otero A, Romaris M, Cancelo M, Muñoz A (1989) Computer prediction of the evolution of mollusc cultures: application to *Ostrea edulis* culture. *Aquacultural Engineering* 8: 165-176.
- Falaise C, François C, Travers M, Morga B, Haure J, Tremblay R, Turcotte F, Pasetto P, Gastineau R, Hardivillier Y, Leignel V, Mouget JL (2016) Antimicrobial compounds from eukaryotic microalgae against human pathogens and diseases in aquaculture. *Marine Drugs* 14: 1-27.
- Fankboner PV, De Burgh ME (1978) Comparative rates of dissolved organic carbon accumulation by juveniles and pediveligers of the Japanese oyster *Crassostrea gigas* Thunberg. *Aquaculture* 13: 205-212.
- Fariñas-Franco JM, Pearce B, Mair JM, Harries DB, MacPherson RC, Porter JS, Reimer PJ, Sanderson WG (2018) Missing native oyster (*Ostrea edulis* L.) beds in a European marine protected area: should there be widespread restorative management? *Biological Conservation* 221: 293-311.
- Farley CA (1978) Viruses and viruslike lesions in marine mollusks. *Marine Fisheries Review* 40: 18-20.
- Fernández Robledo JA, Vasta GR, Record NR (2014) Protozoan parasites of bivalve molluscs: literature follows culture. *PLOS One* 9: 1-9.
- Fernando W, MacBride EW (1931) The origin and development of the pericardium and kidneys in *Ostrea*. *Proceedings of the Royal Society of London. Series B, Containing Papers of a Biological Character* 107: 391-397.
- Ferreiro MJ, Pérez-Camacho A, Labarta U, Beiras R, Planas M, Fernández-Reiriz MJ (1990) Changes in the biochemical composition of *Ostrea edulis* larvae fed on different food regimes. *Marine Biology* 106: 395-401.
- Fitt WK, Coon SL, Walch M, Weiner RM, Colwell RR, Bonar DB (1990) Settlement behavior and metamorphosis of oyster larvae (*Crassostrea gigas*) in response to bacterial supernatants. *Marine Biology* 106: 389-394.
- Flannery G, Lynch SA, Carlsson J, Cross TF, Culloty SC (2014) Assessment of the impact of a pathogen, *Bonamia ostreae*, on *Ostrea edulis* oyster stocks with different histories of exposure to the parasite in Ireland. *Aquaculture* 432: 243-251.
- Flannery G, Lynch SA, Culloty SC (2016) Investigating the significance of the role of *Ostrea edulis* larvae in the transmission and transfer of *Bonamia ostreae*. *Journal of Invertebrate Pathology* 136: 7-9.

- Flassch JP, L'Herroux M, Laubier L (1975) Continuous spat production of flat oyster: *Ostrea edulis* in running water. *Proceedings of the Annual Meeting - World Mariculture Society* 6: 193-201.
- Friedman CS, Perkins FO (1994) Range extension of *Bonamia ostreae* to Maine, U.S.A. *Journal of Invertebrate Pathology* 64: 179-181.
- Friele H (1899) The oyster ponds on the west coast of Norway. In: Brunchorst J (ed.) *Proceedings of the International Congress of Fisheries Bergen*, pp. 188-200. John Griegs Boktrykkeri AS, Bergen, Norway.
- Frolov AV, Pankov SL (1992) The reproduction strategy of oyster *Ostrea-edulis* L from the biochemical point-of-view. *Comparative Biochemistry and Physiology* 103B: 161-182.
- Funes VG, Jiménez RA (1989) Histological identification of the gonadal phases of the European oyster (*Ostrea edulis*), introduced experimentally into the Northwestern Coast of Baja California, Mexico. *Ciencias Marinas* 15: 41-54.
- Gaarder T, Bjerkan P (1934) *Østers og Østerskultur i Norge*, A.s John Griegs Boktrykkeri, Bergen, Norway.
- Gaarder T, Spärck R (1931) Biochemical and biological investigations of the variations in the productivity of the West Norwegian oyster pools. *ICES Marine Science Symposia. Volume 75*, pp. 47-58. International Council for the Exploration of the Sea, Copenhagen, Denmark.
- Gaffney PM (2006) The role of genetics in shellfish restoration. *Aquatic Living Resources* 19: 277-282.
- Gagné N, Cochennec N, Stephenson M, McGladdery S, Meyer GR, Bower SM (2008) First report of a Mikrocytos-like parasite in European oysters *Ostrea edulis* from Canada after transport and quarantine in France. *Diseases of Aquatic Organisms* 80: 27-35.
- García-Lavandeira M, Silva A, Abad M, Pazos AJ, Sánchez JL, Pérez-Parallé ML (2005) Effects of GABA and epinephrine on the settlement and metamorphosis of the larvae of four species of bivalve molluscs. *Journal of Experimental Marine Biology and Ecology* 316: 149-156.
- Garcia-Meunier P, Martel C, Pigeot J, Chevalier G, Blanchard G, Gouletquer P, Robert S, Sauriau PG (2002) Recent invasion of the Japanese oyster drill along the French Atlantic coast: identification of specific molecular markers that differentiate Japanese, *Ocenebrellus inornatus*, and European, *Ocenebra erinacea*, oyster drills. *Aquatic Living Resources* 15: 67-71.
- Gavrilović A, Jug-Dujaković J, Ljubičić A, Conides A (2015) The evaluation of the efficiency of different systems for European flat oyster, *Ostrea edulis* (Linnaeus, 1758) spat rearing. In: Pospišil M (ed.) *Proceedings of the 50th Croatian and the 10th International Symposium on Agriculture*, pp. 379-383. University of Zagreb, Faculty of Agriculture, Zagreb, Croatia.
- Genard B, Larouche O, Nicolas JL, Miner P, Beaudin ML, Tremblay R (2014) Effect of the probiotic strain *Phaeobacter gallaeciensis* after bacterial challenge on the complete larval development of *Pecten maximus*. *Aquatic Living Resources* 27: 27-34.
- Gendreau S (1988) Fécondation in vitro et induction de la polyploidie chez l'huitre plate larvipare, *Ostrea edulis* L. [In vitro fertilization and induction of polyploidy in larviparous flat oyster *Ostrea edulis* L.], Publisher, PhD/DEA Thesis. University of Western Brittany, France.
- Gendreau S, Grizel H (1990) Induced triploidy and tetraploidy in the European flat oyster, *Ostrea edulis* L. *Aquaculture* 90: 229-238.
- Gérard A, Naciri-Graven Y, Boudry P, Launay S, Heurtebise S, Ledu C, Phelipot P (1997) Contrôle de la gamétogenèse des huîtres creuses et plates: relations "reproduction" et "génétique" [Gametogenesis control of hollow and flat oysters: reproductive and genetic relationships]. In: Devauchelle N, Barret J, Salaun G (ed.) *The Natural and Controlled Reproduction of Cultivated Bivalves in France: Symposium Report*, pp. 99-111. IFREMER, Nantes, France.
- Gerbe Z (1876) Aptitude qu'ont les huîtres à se reproduire dès la première année [The ability of oysters to reproduce in their first year]. *Revue et Magasin de Zoologie Pure et Appliquée* 3: 274-278.
- Gercken J, Schmidt A (2014) Current status of the European oyster (*Ostrea edulis*) and possibilities for restoration in the German North Sea. (ed.) *BfN Skripten* 379, pp. 1-96. Federal Agency for Nature Conservation, Germany.
- Gervais O, Renault T, Arzul I (2015) Induction of apoptosis by UV in the flat oyster, *Ostrea edulis*. *Fish & Shellfish Immunology* 46: 232-242.
- Ghribi F, Boussoufa D, Aouini F, Bejaoui S, Chetoui I, Rabeh I, El Cafsi M (2018) Seasonal variation of biochemical composition of Noah's ark shells (*Arca noae* L. 1758) in a Tunisian coastal lagoon in relation to its reproductive cycle and environmental conditions. *Aquatic Living Resources* 31: 1-15.
- Gillies C, Crawford C, Hancock B (2017) Restoring Angasi oyster reefs: what is the endpoint ecosystem we are aiming for and how do we get there? *Ecological Management & Restoration* 18: 214-222.
- González-Araya R (2012) Incidence de la nutrition sur la reproduction et le développement larvaire d'*Ostrea edulis* [Impact of nutrition on reproduction and larval development of *Ostrea edulis*], Publisher, PhD/Dr Thesis. University of Brest, France.

- González-Araya R, Lebrun L, Quéré C, Robert R (2012a) The selection of an ideal diet for *Ostrea edulis* (L.) broodstock conditioning (Part B). *Aquaculture* 362: 55-66.
- González-Araya R, Mingant C, Petton B, Robert R (2012b) Influence of diet assemblage on *Ostrea edulis* broodstock conditioning and subsequent larval development. *Aquaculture* 364: 272-280.
- González-Araya R, Quéau I, Quéré C, Moal J, Robert R (2011) A physiological and biochemical approach to selecting the ideal diet for *Ostrea edulis* (L.) broodstock conditioning (Part A). *Aquaculture Research* 42: 710-726.
- González-Araya R, Quillien V, Robert R (2013) The effects of eight single microalgal diets on sex-ratio and gonad development throughout European flat oyster (*Ostrea edulis* L.) conditioning. *Aquaculture* 400: 1-5.
- González-Araya R, Robert R (2018) Larval development and fatty acid composition of *Ostrea edulis* (L.) fed four different single diets from conditioning to pre-settlement. *Aquaculture Research* 49: 1-14.
- González-Wangüemert M, Pérez-Ruzafa A, Rosique MJ, Ortiz A (2004) Genetic differentiation in two cryptic species of *Ostreidae*, *Ostrea edulis* (Linnaeus, 1758) and *Ostreola stentina* (Payraudeau, 1826) in Mar Menor Lagoon, southwestern Mediterranean Sea. *The Nautilus* 118: 103-111.
- Goreau TJ (2012) Marine electrolysis for building materials and environmental restoration. In: Linkov V, Kleperis J (ed.) *Electrolysis*, pp. 273-290. InTech, Rijeka, Croatia.
- Gosling E (2003) *Bivalve Molluscs: Biology, Ecology and Culture*, Fishing News Books, Blackwell Publishing, Oxford, UK.
- Goulden EF, Høj L, Hall MR (2013) Microbial management for bacterial pathogen control in invertebrate aquaculture hatcheries. In: Allan G, Burnell G (ed.) *Advances in Aquaculture Hatchery Technology*, pp. 246-285. Woodhead Publishing Limited, Cambridge, UK.
- Gouletquer P, Héral M (1997) Marine molluscan production trends in France: from fisheries to aquaculture. In: MacKenzie CL, Burrell VG, Rosenfield A, Hobart WL (ed.) *The History, Present Condition, and Future of the Molluscan Fisheries of North and Central America and Europe*, pp. 137-164. Scientific Publications Office, NMFS, NOAA, Seattle, USA.
- Green DS (2016) Effects of microplastics on European flat oysters, *Ostrea edulis* and their associated benthic communities. *Environmental Pollution* 216: 95-103.
- Grizel H (1985) Etude des récentes épizooties de l'huitre plate *Ostrea edulis* Linne et de leur impact sur l'ostréiculture bretonne [Study of recent epizootics of the flat oyster *Ostrea edulis* Linne and their impact on oyster farming in Brittany], Publisher, PhD/Dr Thesis. University of Montpellier, France.
- Grizel H, Bachere E, Mialhe E, Tige G (1987) Solving parasite-related problems in cultured molluscs. *International Journal for Parasitology* 17: 301-308.
- Grizel H, Comps M, Raguene D, Le Borgne Y, Tigé G, Martin AG (1983) Bilan des essais d'acclimatation d'*Ostrea chilensis* sur les côtes de Bretagne [Results of the acclimatization experiments of *Ostrea chilensis* on the Brittany Coasts]. *Revue des Travaux de l'Institut des Pêches Maritimes* 46: 209-225.
- Grizel H, Héral M (1991) Introduction into France of the Japanese oyster (*Crassostrea gigas*). *ICES Journal of Marine Science* 47: 399-403.
- Guesdon K, Le Bec C, Mazurie J, Lassale E (1989) Essais de télécapage : huitre plate [Remote setting trials: flat oyster]. (ed.) *Section Régionale de Bretagne Sud : Plan de Relance de l'Huitre Plate 1989*, pp. 1-87. CIC-IFREMER, Auray, France.
- Günther RT (1897) The oyster culture of the ancient Romans. *Journal of the Marine Biological Association of the United Kingdom* 4: 360-365.
- Guo L, Xu F, Feng Z, Zhang G (2016) A bibliometric analysis of oyster research from 1991 to 2014. *Aquaculture International* 24: 327-344.
- Guo X (2009) Use and exchange of genetic resources in molluscan aquaculture. *Reviews in Aquaculture* 1: 251-259.
- Guo X, DeBrosse GA, Allen SK (1996) All-triploid Pacific oysters (*Crassostrea gigas* Thunberg) produced by mating tetraploids and diploids. *Aquaculture* 142: 149-161.
- Guy C, Blight A, Smyth D, Roberts D (2018a) The world is their oyster: differences in epibiota on sympatric populations of native *Ostrea edulis* and non-native *Crassostrea gigas* (*Magallana gigas*) oysters. *Journal of Sea Research* 140: 52-58.
- Guy C, Smyth D, Roberts D (2018b) The importance of population density and inter-individual distance in conserving the European oyster *Ostrea edulis*. *Journal of the Marine Biological Association of the United Kingdom* 99: 1-7.
- Hadfield MG, Carpizo-Ituarte EJ, del Carmen K, Nedved BT (2001) Metamorphic competence, a major adaptive convergence in marine invertebrate larvae. *American Zoologist* 41: 1123-1131.

- Haelters J, Kerckhof F (2009) Background document for *Ostrea edulis* and *Ostrea edulis* beds. (ed.) *OSPAR Commission - Biodiversity Series*, pp. 1-22, London, UK.
- Hagmeier A (1916) Ueber die Fortpflanzung der Auster und die fiskalischen Austernbänke [About the reproduction of oysters and the fiscal oyster beds]. *Wissenschaftliche Meeresuntersuchungen. Abt. Helgoland* XI: 221-249.
- Hancock DA (1954) The destruction of oyster spat by *Urosalpinx cinerea* (Say) on Essex oyster beds. *ICES Journal of Marine Science* 20: 186-196.
- Hargreaves JA (2011) Molluscan shellfish aquaculture and best management practices. In: Shumway SE (ed.) *Shellfish Aquaculture and the Environment*, pp. 51-80. John Wiley & Sons, Inc., Oxford, UK.
- Hassan MM, Qin JG, Li XX (2015) Sperm cryopreservation in oysters: a review of its current status and potentials for future application in aquaculture. *Aquaculture* 438: 24-32.
- Hassan MM, Qin JG, Li XX (2017) Gametogenesis, sex ratio and energy metabolism in *Ostrea angasi*: implications for the reproductive strategy of spermcasting marine bivalves. *Journal of Molluscan Studies* 84: 1-8.
- Hawkins AJS, Day AJ, Gerard A, Naciri Y, Ledu C, Bayne BL, Héral M (1994) A genetic and metabolic basis for faster growth among triploids induced by blocking meiosis I but not meiosis II in the larviparous European flat oyster, *Ostrea edulis* L. *Journal of Experimental Marine Biology and Ecology* 184: 21-40.
- Hedgecock D (2011) Genetics of shellfish on a human-dominated planet. In: Shumway SE (ed.) *Shellfish Aquaculture and the Environment*, pp. 339-357. John Wiley & Sons, Inc., Oxford, UK.
- Hedgecock D, Launey S, Pudovkin AI, Naciri Y, Lapegue S, Bonhomme F (2007) Small effective number of parents ( $N_b$ ) inferred for a naturally spawned cohort of juvenile European flat oysters *Ostrea edulis*. *Marine Biology* 150: 1173-1182.
- Helland-Hansen B (1908) Die Austernbassins in Norwegen [The oyster basins in Norway]. *International Review of Hydrobiology* 1: 553-573.
- Helm MM (1971) The effect of seawater quality on the laboratory culture of *Ostrea edulis* L. larvae. *ICES CM Document K:28*, pp. 1-12. International Council for the Exploration of the Sea, Copenhagen, Denmark.
- Helm MM (1977) Mixed algal feeding of *Ostrea edulis* larvae with *Isochrysis galbana* and *Tetraselmis suecica*. *Journal of the Marine Biological Association of the United Kingdom* 57: 1019-1029.
- Helm MM, Bourne N, Lovatelli A (2004) Hatchery culture of bivalves: a practical manual. (ed.) *FAO Fisheries Technical Paper 471*, pp. 1-203. Food and Agriculture Organization of the United Nations, Rome, Italy.
- Helm MM, Holland DL, Stephenson RR (1973) The effect of supplementary algal feeding of a hatchery breeding stock of *Ostrea edulis* L. on larval vigour. *Journal of the Marine Biological Association of the United Kingdom* 53: 673-684.
- Helm MM, Spencer BE (1972) The importance of the rate of aeration in hatchery cultures of the larvae of *Ostrea edulis* L. *ICES Journal of Marine Science* 34: 244-255.
- Hepper BT (1956) The European flat oyster, *Ostrea edulis* L., as a host for *Mytilicola intestinalis* Steuer. *Journal of Animal Ecology* 25: 144-147.
- Héral M (1990) Traditional oyster culture in France. In: Barnabé G, de IB Solbe JF (ed.) *Aquaculture*, pp. 342-387. Ellis Horwood, Chichester, UK.
- Héral M, Alzieu C, Deslous-Paoli JM (1989) Effect of organotin compounds (TBT) used in antifouling paints on cultured marine molluscs - a literature study. In: De Pauw N, Jaspers E, Ackefors H, Wilkins N (ed.) *Aquaculture: a Biotechnology in Progress: Proceedings of the International Conference Aquaculture Europe*, pp. 1081-1089. European Aquaculture Society, Bredene, Belgium.
- Héral M, Deslous-Paoli JM (1991) Oyster culture in European countries. In: Menzel W (ed.) *Estuarine and Marine Bivalve Mollusk Culture*, pp. 153-190. CRC Press Inc., Boca Raton, USA.
- Heras H, Kean-Howie J, Ackman RG (1994) The potential use of lipid microspheres as nutritional supplements for adult *Ostrea edulis*. *Aquaculture* 123: 309-322.
- Hidu H, Chapman S, Soule PW (1975) Cultchless setting of European oysters, *Ostrea edulis*, using polished marble. *Proceedings of the National Shellfisheries Association* 65: 13-14.
- Hidu H, Lavoie RE (1991) The European oyster, *Ostrea edulis* L., in Maine and Eastern Canada. In: Menzel W (ed.) *Estuarine and Marine Bivalve Mollusk Culture*, pp. 35-46. CRC Press Inc., Boca Raton, USA.
- Hidu H, Tubiash HS (1963) A bacterial basis for the growth of antibiotic-treated bivalve larvae. *Proceedings of the National Shellfisheries Association* 54: 25-39.
- Hine PM, Engelsma MY, Wakefield SJ (2007) Ultrastructure of sporulation in *Haplosporidium armoricanum*. *Diseases of Aquatic Organisms* 77, 225-233.



- Hintz M, Gratz K, Becker B, Vadopalas B, Roberts S (2017) A nonlethal anesthesia protocol for accessing the mantle cavity of olympia oysters in the laboratory or field. *Journal of Shellfish Research* 36: 353-357.
- His E, Beiras R, Seaman MNL (1999) The assessment of marine pollution - bioassays with bivalve embryos and larvae. In: Southward AJ, Tyler PA, Young CM (ed.) *Advances in Marine Biology*, pp. 1-178. Academic Press, London, UK.
- Hoeksema BW (1983) Excavation patterns and spiculae dimensions of the boring sponge *Cliona celata* from the SW Netherlands. *Senckenbergiana Maritima* 15: 55-85.
- Holden G, Rosenberg G, Barker K (2005) Tracing thought through time and space. *Social Work in Health Care* 41: 1-34.
- Holland DL, Spencer BE (1973) Biochemical changes in fed and starved oysters, *Ostrea edulis* L. during larval development, metamorphosis and early spat growth. *Journal of the Marine Biological Association of the United Kingdom* 53: 287-298.
- Holmes JMC, Minchin D (1991) A new species of Herrmannella (Copepoda, Poecilostomatoida, Sabelliphilidae) associated with the oyster *Ostrea edulis* L. *Crustaceana* 60: 258-269.
- Hopkins AE (1937) Experimental observations on spawning, larval development, and setting in the Olympia oyster, *Ostrea lurida*. *Bulletin of the Bureau of Fisheries* 48: 439-503.
- Horst R (1884) The development of the oyster (*Ostrea edulis* L.). *Report of the Commissioner for 1884* 12: 891-911.
- Horváth Á, Bubalo A, Čučević A, Bartulović V, Kotrik L, Urbányi B, Glamuzina B (2012) Cryopreservation of sperm and larvae of the European flat oyster (*Ostrea edulis*). *Journal of Applied Ichthyology* 28: 948-951.
- Huggins WL, Helm MM, Williams DR (1987) Automatic control of food supply in the culture of filter-feeding organisms. *Aquacultural Engineering* 6: 259-275.
- Hugh Jones D (1999) Breeding ponds as a basis for flat oyster (*Ostrea edulis*) culture and their use to develop resistance to the disease *Bonamia ostreae*. *Journal of Shellfish Research* 18: 718-718.
- Hughes AR, Inouye BD, Johnson MTJ, Underwood N, Vellend M (2008) Ecological consequences of genetic diversity. *Ecology Letters* 11: 609-623.
- Hughes E (1940) The breeding of oysters in tanks. *Journal of the Marine Biological Association of the United Kingdom* 24: 543-547.
- Hurwood DA, Heasman MP, Mather PB (2005) Gene flow, colonisation and demographic history of the flat oyster *Ostrea angasi*. *Marine and Freshwater Research* 56: 1099-1106.
- Igic L (1981) The biomass of fouling communities on edible shellfish: oyster (*Ostrea edulis*) and mussel (*Mytilus galloprovincialis*) in the Northern Adriatic. *Thalassia Jugoslavica* 17: 17-19.
- Imai T, Sakai SI, Okada H (1952) Transplantation of European flat oyster, *O. edulis*, into Japanese water and its breeding in tanks. *Tohoku Journal of Agricultural Research* 3: 311-320.
- Ivanov AI (1964) Размножение, рост и распределение черноморских устриц [Breeding, growth and distribution of Black Sea oysters]. (ed.) *Sbornik Nauchno-Tekhnicheskoy Informatsii VNIRO* 3, pp. 3-13. Russian Research Institute of Fisheries and Oceanography, Moscow, Russia.
- Ivanov AI (1965) Влияние воды различной солености на выживание личинок черноморских устриц (*Ostrea taurica* Kryn.) [The effect of different degrees of water salinity on the survival of Black Sea oyster larvae (*Ostrea taurica* Kryn.)]. *Доклады Академии наук СССР* 163: 1256-1258.
- Ivanov AI (1966a) Present stocks and distribution of oysters (*Ostrea taurica* Kryn.) in the Black Sea. *Oceanology of the Russian Academy of Sciences* 6: 568-572.
- Ivanov AI (1966b) Study of oyster (*Ostrea taurica* Kryn) growth in the Black Sea. *Oceanology of the Russian Academy of Sciences* 6: 708-714.
- Jarayabhand P (1988) The effects of age, size, and stocking density on survival and growth of *Ostrea edulis*. *Journal of Shellfish Research* 7, 164-165.
- Jeffries VE (1982) Three vibrio strains pathogenic to larvae of *Crassostrea gigas* and *Ostrea edulis*. *Aquaculture* 29: 201-226.
- Jefferies AG (1999) The potential for developing controlled breeding in the Chilean oyster. *Aquaculture International* 7: 189-199.
- Johannesson K, Rödström EM, Aase H (1989) Low genetic variability in Scandinavian populations of *Ostrea edulis* L. - possible causes and implications. *Journal of Experimental Marine Biology and Ecology* 128: 177-190.
- Jones G, Jones B (1982) Methods for setting hatchery produced oyster larvae. (ed.) *Information Report No. 4*, pp. 1-66. Marine Resources Branch, Ministry of Environment, British Columbia, Canada.
- Jones GG, Jones BL (1988) Advances in the remote setting of oyster larvae. (ed.) *Report of the Ministry of Agriculture and Fisheries, British Columbia*, pp. 1-88. B.C. M.A.S., Nanaimo, Canada.

- Jones JB (2006) Why won't they grow? – Inhibitory substances and mollusc hatcheries. *Aquaculture International* 14: 395-403.
- Joyce A, Holthuis TD, Charrier G, Lindegarth S (2013) Experimental effects of temperature and photoperiod on synchrony of gametogenesis and sex ratio in the European oyster *Ostrea edulis* (Linnaeus). *Journal of Shellfish Research* 32: 447-458.
- Jozefowicz CJ, Ó Foighil D (1998) Phylogenetic analysis of southern hemisphere flat oysters based on partial mitochondrial 16S rDNA gene sequences. *Molecular Phylogenetics and Evolution* 10: 426-435.
- Kamermans P, Blanco A, Joaquim S, Matias D, Magnesen T, Nicolas JL, Petton B, Robert R (2016) Recirculation nursery systems for bivalves. *Aquaculture International* 24: 827-842.
- Kamermans P, Walles B, Kraan M, van Duren L, Kleissen F, van der Have T, Smaal A, Poelman M (2018) Offshore wind farms as potential locations for flat oyster (*Ostrea edulis*) restoration in the Dutch North Sea. *Sustainability* 10: 3942, 1-24.
- Kamphausen L, Jensen A, Hawkins L (2011) Unusually high proportion of males in a collapsing population of commercially fished oysters (*Ostrea edulis*) in the Solent, United Kingdom. *Journal of Shellfish Research* 30: 217-222.
- Kändler R (1928) Untersuchungen über die Biologie der Auster. Nr. 3. Verbreitung und Wachstum der Austernbrut im Wattenmeer [Studies on the biology of the oyster. Distribution and growth of the oyster breeding in the Wadden Sea]. *Wissenschaftliche Meeresuntersuchungen. Abt. Helgoland XVII*: 1-35.
- Kang DH, Kim SJ, Choi KS (2004) Microscopic observations of larval *Ostrea circumpicta* (Bivalve: Ostreidae) in brood chambers. *Journal of Shellfish Research* 23: 411-415.
- Kat M (1984) "Red" oysters (*Ostrea edulis* L.) caused by *Mesodinium rubrum* in Lake Grevelingen. *Aquaculture* 38: 375-377.
- Kennedy RJ, Roberts D (1999) A survey of the current status of the flat oyster *Ostrea edulis* in Strangford Lough, Northern Ireland, with a view to the restoration of its oyster beds. *Biology and Environment: Proceedings of the Royal Irish Academy* 99B: 79-88.
- Kennedy RJ, Roberts D (2006) Commercial oyster stocks as a potential source of larvae in the regeneration of *Ostrea edulis* in Strangford Lough, Northern Ireland. *Journal of the Marine Biological Association of the United Kingdom* 86: 153-159.
- Kerckhof F, Coolen JWP, Rumes B, Degraer S (2018) Recent findings of wild European flat oysters *Ostrea edulis* (Linnaeus, 1758) in Belgian and Dutch offshore waters: new perspectives for offshore oyster reef restoration in the southern North Sea. *Belgian Journal of Zoology* 148: 13-24.
- Kerr R, Ward GM, Stentiford GD, Alfjorden A, Mortensen S, Bignell JP, Feist SW, Villalba A, Carballal MJ, Cao A (2018) *Marteilia refringens* and *Marteilia pararefringens* sp. nov. are distinct parasites of bivalves and have different European distributions. *Parasitology* 145: 1483-1492.
- Kesarcodi-Watson A, Miner P, Nicolas JL, Asmani K, Robert R (2016) Pathogenic threats and probiotic use in larviculture of the scallop, *Pecten maximus*. *Aquaculture Research* 47: 1-10.
- Kesarcodi-Watson A, Miner P, Nicolas JL, Robert R (2012) Protective effect of four potential probiotics against pathogen-challenge of the larvae of three bivalves: Pacific oyster (*Crassostrea gigas*), flat oyster (*Ostrea edulis*) and scallop (*Pecten maximus*). *Aquaculture* 344-349: 29-34.
- Khouw BT (1965) Some studies on the biology of a species of *Hexamita* derived from the oyster, *Crassostrea virginica* (Gmelin), Publisher, MSc Thesis. University of Windsor, Canada.
- Kinne O (1976) Cultivation of marine organisms: water quality management and technology. In: Kinne O (ed.) *Marine Ecology: A Comprehensive, Integrated Treatise on Life in Oceans and Coastal Waters*, pp. 19-300. Wiley-Interscience, London, UK.
- Kirk RG (1982) The origins of the French oyster industry. *Aquacultural Engineering* 1: 55-62.
- Kirkland DW, Bradbury JP, Dean WE (1980) The heliothermic lake: a direct method of collecting and storing solar energy. (ed.) *Open-File Report 80-807*, pp. 1-133. US Geological Survey, USA.
- Klaveness D (1990) Size structure and potential food value of the plankton community to *Ostrea edulis* L. in a traditional Norwegian "Østerspoll". *Aquaculture* 86: 231-247.
- Klaveness D (1992) Augmentation of the food supply for oyster larvae via bacterivorous flagellates: possible implications for larval breeding and oyster pond management. *Aquaculture Research* 23: 591-597.
- Klaveness D, Johansen SW (1990) The oyster ponds at the Norwegian coast: remarkable biotopes for marine algae. *Blyttia* 48: 27-31.
- Knauer J, Southgate PC (1999) A Review of the nutritional requirements of bivalves and the development of alternative and artificial diets for bivalve aquaculture. *Reviews in Fisheries Science* 7, 241-280.

- Knight-Jones EW (1952) Reproduction of oysters in the rivers Crouch and Roach, Essex, during 1947, 1948 and 1949. (ed.) *Fishery Investigations Series II*, pp. 1-48. Her Majesty's Stationery Office, London, UK.
- Korringa P (1940) Experiments and observations on swarming, pelagic life and setting in the European flat oyster, *Ostrea Edulis* L., Publisher, PhD/Dr Thesis. University of Amsterdam, The Netherlands.
- Korringa P (1946a) The decline of natural oyster beds. *Basteria* 10: 36-41.
- Korringa P (1946b) A revival of natural oyster beds? *Nature* 158: 586-587.
- Korringa P (1947) Relations between the moon and periodicity in the breeding of marine animals. *Ecological Monographs* 17: 347-381.
- Korringa P (1950) A review of the papers on molluscs presented at the special scientific meeting on shellfish of the International Council for the Exploration of the Sea, Edinburgh, 10th October 1949. *ICES Journal of Marine Science* 17: 44-59.
- Korringa P (1951) Difficulties encountered in tank-breeding of oysters (*Ostrea edulis*). *ICES Marine Science Symposia. Volume 128-2*, pp. 35-38. International Council for the Exploration of the Sea, Copenhagen, Denmark.
- Korringa P (1952) Recent advances in oyster biology. *The Quarterly Review of Biology* 27: 266-308.
- Korringa P (1954) The shell of *Ostrea edulis* as a habitat. *Archives Néerlandaises de Zoologie* 10: 32-146.
- Korringa P (1957) Water temperature and breeding throughout the geographical range of *Ostrea edulis*. *L'Année Biologique* 33: 1-17.
- Korringa P (1976) *Farming the Flat Oysters of the Genus Ostrea. Developments in Aquaculture and Fisheries Science*, Elsevier Scientific Publishing Company, Amsterdam, The Netherlands.
- Kristensen PS (1997) Oyster and mussel fisheries in Denmark. In: MacKenzie CL, Burrell VG, Rosenfield A, Hobart WL (ed.) *The History, Present Condition, and Future of the Molluscan Fisheries of North and Central America and Europe*, pp. 25-38. Scientific Publications Office, NMFS, NOAA, Seattle, USA.
- Kumar G, Engle C, Tucker C (2018) Factors driving aquaculture technology adoption. *Journal of the World Aquaculture Society* 49: 447-476.
- Labarta U, Fernández-Reiriz MJ, Pérez-Camacho A (1999) Larvae of *Ostrea edulis* (L.) during starvation: growth, energy and biochemical substrates. *Hydrobiologia* 405: 125-131.
- Laing I (1995) Effect of food supply on oyster spatfall. *Aquaculture* 131: 315-324.
- Laing I, Millican PF (1986) Relative growth and growth efficiency of *Ostrea edulis* L. spat fed various algal diets. *Aquaculture* 54: 245-262.
- Laing I, Walker P, Areal F (2006) Return of the native - is European oyster (*Ostrea edulis*) stock restoration in the UK feasible? *Aquatic Living Resources* 19: 283-287.
- Lallias D, Arzul I, Heurtebise S, Ferrand S, Chollet B, Robert M, Beaumont AR, Boudry P, Morga B, Lapègue S (2008) *Bonamia ostreae*-induced mortalities in one-year old European flat oysters *Ostrea edulis*: experimental infection by cohabitation challenge. *Aquatic Living Resources* 21: 423-439.
- Lallias D, Beaumont AR, Haley CS, Boudry P, Heurtebise S, Lapegue S (2007) A first-generation genetic linkage map of the European flat oyster *Ostrea edulis* (L.) based on AFLP and microsatellite markers. *Animal Genetics* 38: 560-568.
- Lallias D, Boudry P, Lapègue S, King JW, Beaumont AR (2010a) Strategies for the retention of high genetic variability in European flat oyster (*Ostrea edulis*) restoration programmes. *Conservation Genetics* 11: 1899-1910.
- Lallias D, Gomez-Raya L, Haley CS, Arzul I, Heurtebise S, Beaumont AR, Boudry P, Lapègue S (2009a) Combining two-stage testing and interval mapping strategies to detect QTL for resistance to Bonamiosis in the European flat oyster *Ostrea edulis*. *Marine Biotechnology* 11: 570.
- Lallias D, Stockdale R, Boudry P, Beaumont AR, Lapègue S (2009b) Characterization of 27 microsatellite loci in the European flat oyster *Ostrea edulis*. *Molecular Ecology Resources* 9: 960-963.
- Lallias D, Taris N, Boudry P, Bonhomme F, Lapegue S (2010b) Variance in the reproductive success of flat oyster *Ostrea edulis* L. assessed by parentage analyses in natural and experimental conditions. *Genetics Research* 92: 175-187.
- Lama A, Montes J (1993) Influence of depth of culture in the infection of the European flat oyster (*Ostrea edulis* L.) by *Bonamia ostreae*. *Bulletin of the European Association of Fish Pathologists* 13: 17-20.
- Lane A (1989) The effect of a microencapsulated fatty acid diet on larval production in the European flat oyster *Ostrea edulis* L. In: De Pauw N, Jaspers E, Ackefors H, Wilkins N (ed.) *Aquaculture: a Biotechnology in Progress: Proceedings of the International Conference Aquaculture Europe*, pp. 657-664. European Aquaculture Society, Bredene, Belgium.

- Langdon CJ, Siegfried CA (1984) Progress in the development of artificial diets for bivalve filter feeders. *Aquaculture* 39: 135-153.
- Langton RW, Gabbott PA (1974) The tidal rhythm of extracellular digestion and the response to feeding in *Ostrea edulis*. *Marine Biology* 24: 181-187.
- Lapègue S, Beaumont A, Boudry P, Gouletquer P (2007) Genetic effects of domestication, culture and breeding of fish and shellfish, and their impacts on wild populations. European flat oyster - *Ostrea edulis*. In: Svåsand T, Crosetti D, García-Vázquez E, Verspooer E (ed.) *Genetic impact of aquaculture activities on native populations. Genimpact final scientific report (EU contract n. RICA-CT2005-022802)*, pp. 70-75, EU.
- Lassudrie M, Soudant P, Nicolas JL, Miner P, Le Grand J, Lambert C, Le Goïc N, Hégaret H, Fabioux C (2016) Exposure to the toxic dinoflagellate *Alexandrium catenella* modulates juvenile oyster *Crassostrea gigas* hemocyte variables subjected to different biotic conditions. *Fish & Shellfish Immunology* 51: 104-115.
- Launey S, Barre M, Gerard A, Naciri-Graven Y (2001) Population bottleneck and effective size in *Bonamia ostreae*-resistant populations of *Ostrea edulis* as inferred by microsatellite markers. *Genetics Research* 78: 259-270.
- Launey S, Ledu C, Boudry P, Bonhomme F, Naciri-Graven Y (2002) Geographic structure in the European Flat Oyster (*Ostrea edulis* L.) as revealed by microsatellite polymorphism. *Journal of Heredity* 93: 331-351.
- Le Borgne Y (1982) Techniques de reproduction contrôlée des mollusques bivalves pour les élevages extensifs ou le repeuplement : rôle des écloséries-nurseries [Techniques for the controlled reproduction of bivalve molluscs for extensive rearing or restocking: role of hatcheries and nurseries]. In: Buestel D, Nicolas R, Morize E, Rohan R, Latrouite D, Le Borgne Y, Cochard JC, Flassch JP, Uno Y, Audouin J, Legall JY, Jezequel M, Lorec J, Y. H, Reveche C, Girin M, Laurec A, Herry P (ed.) *Aquaculture Extensive et Repeuplement*, pp. 51-54. National Centre for the Exploitation of the Oceans CNEXO, Tours, France.
- Le Borgne Y (1985) Dix ans de production en éclosérie de mollusques bivalves [Ten years of hatchery production of bivalve molluscs]. (ed.) *Bases Biologiques de l'Aquaculture : Montpellier 1983*, pp. 151-154. French Research Institute for Exploitation of the Sea, Brest, France.
- Le Borgne Y (1996) Echanges internationaux des mollusques bivalves et situation actuelle en France et en Europe [International movements of bivalve molluscs and the current situation in France and Europe]. *Revue Scientifique et Technique - Office International des Épizooties* 15: 491-498.
- Le Pennec M (1980) The larval and post-larval hinge of some families of bivalve molluscs. *Journal of the Marine Biological Association of the United Kingdom* 60: 601-617.
- Lee PG (1995) A review of automated control systems for aquaculture and design criteria for their implementation. *Aquacultural Engineering* 14: 205-227.
- Lee PG (2000) Process control and artificial intelligence software for aquaculture. *Aquacultural Engineering* 23: 13-36.
- Lees H (1930) Paper and glass collectors for oyster spat. *ICES Journal of Marine Science* 5: 383-384.
- Lekang OI (2013) Aquaculture hatchery water supply and treatment systems. In: Allan G, Burnell G (ed.) *Advances in Aquaculture Hatchery Technology*, pp. 3-22. Woodhead Publishing Limited, Cambridge, UK.
- Liu Y, Li X, Robinson N, Qin J (2015) Sperm cryopreservation in marine mollusk: a review. *Aquaculture International* 23: 1505-1524.
- Locard A (1900) *Manuel Pratique d'Ostréiculture*, JB Baillièrè & Fils, Paris, France.
- Lodeiros C, Bolinches J, Dopazo CP, Toranzo AE (1987) Bacillary necrosis in hatcheries of *Ostrea edulis* in Spain. *Aquaculture* 65: 15-29.
- Loosanoff VL (1962) Gametogenesis and spawning of the European oyster, *O. edulis*, in waters of Maine. *The Biological Bulletin* 122: 86-94.
- Loosanoff VL, Davis HC (1963) Rearing of bivalve mollusks. In: Russell FS (ed.) *Advances in Marine Biology*, pp. 1-136. Academic Press, Inc., London, UK.
- Loosanoff VL, Engle JB (1939) Spawning and setting of oysters in Long Island Sound in 1937, and discussion of the method for predicting the intensity and time of oyster setting. *Bulletin of the Bureau of Fisheries* 49: 217-255.
- López-Sanmartín M, Batista FM, del Carmen Marín M, Garrido I, Quintero D, Grade A, Ruano F, de la Herrán R, Navas JI (2015) Detection of *Marteilia refringens* infecting the European flat oyster *Ostrea edulis* and the dwarf oyster *Ostrea stentina* in southern Portugal and Spain. *Journal of Invertebrate Pathology* 130: 52-55.
- Lubet P (1991) Reproduction des mollusques [Reproduction of molluscs]. In: Barnabé G (ed.) *Bases Biologiques et Écologiques de l'Aquaculture*, pp. 168-204. Tec & Doc, Lavoisier, Paris, France.

- Lucas A (1970) Conchyliculture expérimentale [Experimental shellfish culture]. (ed.) *CNEXO Série Biologique 70-01*, pp. 1-76. Centre National pour l'Exploration des Océans, Brest, France.
- Luckenbach MW, Coen LD, Ross PGJR, Stephen JA (2005) Oyster reef habitat restoration: relationships between oyster abundance and community development based on two studies in Virginia and South Carolina. *Journal of Coastal Research Special Issue*: 64-78.
- Lynch SA, Armitage DV, Wylde S, Mulcahy MF, Culloty SC (2005) The susceptibility of young prespawning oysters, *Ostrea edulis*, to *Bonamia ostreae*. *Journal of Shellfish Research* 24: 1019-1025.
- Lynch SA, Flannery G, Hugh-Jones T, Hugh-Jones D, Culloty SC (2014) Thirty-year history of Irish (Rossmore) *Ostrea edulis* selectively bred for disease resistance to *Bonamia ostreae*. *Diseases of Aquatic Organisms* 110: 113-121.
- Mace GM (2014) Whose conservation? *Science* 345: 1558-1560.
- MacKenzie CL (1977) Use of quicklime to increase oyster seed production. *Aquaculture* 10: 45-51.
- Mackin JG, Korringa P, Hopkins SH (1951) Hexamitiasis of *Ostrea edulis* L. and *Crassostrea virginica* (Gmelin). *Bulletin of Marine Science* 1: 266-277.
- MacMillan RJ, Cawthorn RJ, Whyte SK, Lyon PR (1994) Design and maintenance of a closed artificial seawater system for long-term holding of bivalve shellfish. *Aquacultural Engineering* 13: 241-250.
- Maestrini SY, Robert JM, Leftley JW, Collos Y (1986) Ammonium thresholds for simultaneous uptake of ammonium and nitrate by oyster-pond algae. *Journal of Experimental Marine Biology and Ecology* 102: 75-98.
- Magnesen T, Jacobsen A (2012) Effect of water recirculation on seawater quality and production of scallop (*Pecten maximus*) larvae. *Aquacultural Engineering* 47: 1-6.
- Manahan DT, Crisp DJ (1982) The role of dissolved organic material in the nutrition of pelagic larvae: amino acid uptake by bivalve veligers. *American Zoologist* 22: 635-646.
- Maneiro V, Pérez-Parallé ML, Pazos AJ, Silva A, Sánchez JL (2016) Combined effects of temperature and photoperiod on the conditioning of the flat oyster (*Ostrea edulis* [Linnaeus, 1758]) in winter. *Journal of Shellfish Research* 35: 137-141.
- Maneiro V, Pérez-Parallé ML, Silva A, Sánchez JL, Pazos AJ (2017a) Conditioning of the European flat oyster (*Ostrea edulis*, Linnaeus 1758): effect of food ration. *Aquaculture Research* 48: 1-8.
- Maneiro V, Silva A, Pazos AJ, Sánchez JL, Pérez-Parallé ML (2017b) Effects of temperature and photoperiod on the conditioning of the flat oyster (*Ostrea edulis* L.) in autumn. *Aquaculture Research* 48: 1-9.
- Mann R (1979) Some biochemical and physiological aspects of growth and gametogenesis in *Crassostrea gigas* and *Ostrea edulis* grown at sustained elevated temperatures. *Journal of the Marine Biological Association of the United Kingdom* 59: 95-110.
- Mann R (1984) Bivalve mollusc hatcheries: a critical appraisal of their development and a review of their potential value in enhancing the fisheries of developing nations. In: Winter JE, Clasing E, Gutierrez A (ed.) *Memorias de la Asociación Latinoamericana de Acuicultura*, pp. 97-105. Universidad Austral de Chile, Valdivia, Chile.
- Mann R, Powell EN (2007) Why oyster restoration goals in the Chesapeake Bay are not and probably cannot be achieved. *Journal of Shellfish Research* 26: 905-917.
- Mann R, Ryther JH (1977) Growth of six species of bivalve molluscs in a waste recycling - aquaculture system. *Aquaculture* 11: 231-245.
- Mardones-Toledo DA, Montory JA, Joyce A, Thompson RJ, Diederich CM, Pechenik JA, Mardones ML, Chaparro OR (2015) Brooding in the Chilean oyster *Ostrea chilensis*: unexpected complexity in the movements of brooded offspring within the mantle cavity. *PLOS One* 10: 1-18.
- Marshall R, McKinley S, Pearce CM (2010) Effects of nutrition on larval growth and survival in bivalves. *Reviews in Aquaculture* 2: 33-55.
- Marteil L (1959) Les bancs naturels et la reproduction de l'huître plate en Morbihan [Natural banks and reproduction of flat oyster in Morbihan]. *Revue des Travaux de l'Institut des Pêches Maritimes* 23: 287-295.
- Marteil L (1976) La conchyliculture française. Partie 2 : biologie de l'huître et de la moule [Shellfish culture in France. Part 2: oyster and mussel biology]. *Revue des Travaux de l'Institut des Pêches Maritimes* 40: 149-346.
- Martin AG, Anonymous (1994) Relance de l'huître plate, *Ostrea edulis* : Bilan des travaux réalisés en 1993 [Revival program for the flat oyster *Ostrea edulis*: Review 1993]. (ed.) *IFREMER Report RIDRV-94.22 RA*, pp. 1-46. French Research Institute for Exploitation of the Sea, La Trinité sur Mer/La Tremblade, France.
- Martin AG, Gerard A, Cochennec N, Langlade A (1993) Selecting flat oysters, *Ostrea edulis*, for survival against the parasite *Bonamia ostreae*: assessment of the resistance of a first selected generation.

- In: Barnabé G, Kestemont P (ed.) *Production, Environment and Quality: Proceedings of the International Conference Bordeaux Aquaculture*, pp. 545-554. European Aquaculture Society, Special Publication, Gent, Belgium.
- Martin AG, Littaye-Mariette A, Langlade A, Allenou JP (1997) Cycle de reproduction naturelle de l'huître plate *Ostrea edulis* [Natural reproductive cycle of the flat oyster *Ostrea edulis*]. In: Devauchelle N, Barret J, Salaun G (ed.) *The Natural and Controlled Reproduction of Cultivated Bivalves in France: Symposium Report*, pp. 21-33. IFREMER, Nantes, France.
- Martin YP, Mengus BM (1977) Use of selected bacterial strains for feeding larvae of *Mytilus galloprovincialis* Lmk in experimental rearing. *Aquaculture* 10: 253-262.
- Mascaró M, Seed R (2001a) Choice of prey size and species in *Carcinus maenas* (L.) feeding on four bivalves of contrasting shell morphology. *Hydrobiologia* 449: 159-170.
- Mascaró M, Seed R (2001b) Foraging behavior of juvenile *Carcinus maenas* (L.) and *Cancer pagurus* L. *Marine Biology* 139: 1135-1145.
- Mattei N, Pellizzato M (1997) Mollusk fisheries and aquaculture in Italy. In: MacKenzie CL, Burrell VG, Rosenfield A, Hobart WL (ed.) *The History, Present Condition, and Future of the Molluscan Fisheries of North and Central America and Europe*, pp. 201-216. Scientific Publications Office, NMFS, NOAA, Seattle, USA.
- Matthews JBL, Heimdal BR (1980) Pelagic productivity and food chains in fjord systems. In: Freeland HJ, Farmer DM, Levings CD (ed.) *Fjord Oceanography*, pp. 377-398. Plenum Press, New-York, USA.
- Medcof JC (1959) Trial introduction of European oysters (*Ostrea edulis* L.) to Canadian east coast. *Proceedings of the National Shellfisheries Association* 50: 113-124.
- Menzel W (1972) Selection and hybridization in the mariculture of oysters and clams. (ed.) *Proceedings of the Annual Workshop*, pp. 309-317. World Mariculture Society, Baton Rouge, USA.
- Meritt D, Webster D (2013) Developing educational programs in partnership with aquaculture hatchery facilities. In: Allan G, Burnell G (ed.) *Advances in Aquaculture Hatchery Technology*, pp. 596-625. Woodhead Publishing Limited, Cambridge, UK.
- Mesías-Gansbiller C, Silva A, Maneiro V, Pazos A, Sánchez JL, Pérez-Parallé ML (2013) Effects of chemical cues on larval settlement of the flat oyster (*Ostrea edulis* L.): a hatchery approach. *Aquaculture* 376: 85-89.
- Milbury CA, Meritt DW, Newell RIE, Gaffney PM (2004) Mitochondrial DNA markers allow monitoring of oyster stock enhancement in the Chesapeake Bay. *Marine Biology* 145: 351-359.
- Millar RH, Scott JM (1967a) Bacteria-free culture of oyster larvae. *Nature* 216: 1139-1140.
- Millar RH, Scott JM (1967b) The larva of the oyster *Ostrea edulis* during starvation. *Journal of the Marine Biological Association of the United Kingdom* 47: 475-484.
- Millar RH, Scott JM (1968) An effect of water quality on the growth of cultured larvae of the oyster *Ostrea edulis* L. *ICES Journal of Marine Science* 32: 123-130.
- Millican PF, Helm MM (1994) Effects of nutrition on larvae production in the European flat oyster, *Ostrea edulis*. *Aquaculture* 123: 83-94.
- Minchin D, Duggan CB (1988) The distribution of the exotic ascidian, *Styela clava* Herdman, in Cork Harbour. *Irish Naturalists' Journal* 22: 388-393.
- Mizuta DD, Wikfors GH (2018) Seeking the perfect oyster shell: a brief review of current knowledge. *Reviews in Aquaculture* 11: 1-17.
- Moebius K (1877) *Die Auster und die Austernwirthschaft*, Verlag von Wiegandt, Hempel & Parey, Berlin, Germany.
- Montes J, Ferro-Soto B, Conchas RF, Guerra A (2003) Determining culture strategies in populations of the European flat oyster, *Ostrea edulis*, affected by bonamiosis. *Aquaculture* 220: 175-182.
- Morga B, Renault T, Faury N, Arzul I (2012) New insights in flat oyster *Ostrea edulis* resistance against the parasite *Bonamia ostreae*. *Fish & Shellfish Immunology* 32: 958-968.
- Morga B, Renault T, Faury N, Lerond S, Garcia C, Chollet B, Joly JP, Lapègue S, Harrang E, Arzul I (2017) Contribution of in vivo experimental challenges to understanding flat oyster *Ostrea edulis* resistance to *Bonamia ostreae*. *Frontiers in Cellular and Infection Microbiology* 7: 1-13.
- Mortensen S, Berthe F, Joly JP, Miossec L (2002) Future strategies for a Norwegian production of seed, *Ostrea edulis* for export. (ed.) *IMR Project Part-Report NUMARIO K32-3025/00*, pp. 1-6. Institute of Marine Research, Bergen, Norway.
- Mortensen S, Sælemyr L, Skår CK, Jelmert A (2018) The surveillance and control programme for bonamiosis and marteiliosis in European flat oysters, *Ostrea edulis*, and blue mussels, *Mytilus* sp. in Norway in 2017. (ed.) *IMR Project Report Nr. 17-2018*, pp. 1-12. Institute of Marine Research, Bergen, Norway.

- Mortensen SH (1992) The health status of commercially exploited native flat oysters (*Ostrea edulis*) in Norway. *ICES CM Document K:44*, pp. 1-10. International Council for the Exploration of the Sea, Copenhagen, Denmark.
- Mortensen SH (1993) Health survey of selected stocks of commercially exploited Norwegian bivalve molluscs. *Diseases of Aquatic Organisms* 16: 149-156.
- Morton B (1971) The diurnal rhythm and tidal rhythm of feeding and digestion in *Ostrea edulis*. *Biological Journal of the Linnean Society* 3: 329-342.
- Morton B, Lam K, Slack-Smith S (2003) First report of the European flat oyster *Ostrea edulis*, identified genetically, from Oyster Harbour, Albany, south-western Western Australia. *Molluscan Research* 23: 199-208.
- Morvezen R, Boudry P, Laroche J, Charrier G (2016) Stock enhancement or sea ranching? Insights from monitoring the genetic diversity, relatedness and effective population size in a seeded great scallop population (*Pecten maximus*). *Heredity* 117: 142-148.
- Muehlbauer F, Fraser D, Brenner M, Van Nieuwenhove K, Buck BH, Strand O, Mazurié J, Thorarindottir G, Dolmer P, O'Beirn F, Sanchez-Mata A, Flimlin G, Kamermans P (2014) Bivalve aquaculture transfers in Atlantic Europe. Part A: Transfer activities and legal framework. *Ocean & Coastal Management* 89: 127-138.
- Muller-Feuga A, Robert R, Cahu C, Robin J, Divanach P (2003) Uses of microalgae in aquaculture. In: Støttrup JG, McEvoy LA (ed.) *Live Feeds in Marine Aquaculture*, pp. 253-299. Blackwell Science Ltd, Oxford, UK.
- Mustafa S (2003) Stock enhancement and sea ranching: objectives and potential. *Reviews in Fish Biology and Fisheries* 13: 141-149.
- Naas KE (1991) A semi-intensive method for spat production of the European flat oyster (*Ostrea edulis* L.). *Aquacultural Engineering* 9: 447-451.
- Naas KE, Berg L, Øiestad V (1986) Effect of turbulence and different types of fertilizers on phytoplankton and oyster larvae (*Ostrea edulis*) in mesocosms. *ICES CM Document K:41*, pp. 1-12. International Council for the Exploration of the Sea, Copenhagen, Denmark.
- Naciri-Graven Y, Martin AG, Baud JP, Renault T, Gerard A (1998) Selecting the flat oyster *Ostrea edulis* (L.) for survival when infected with the parasite *Bonamia ostreae*. *Journal of Experimental Marine Biology and Ecology* 224: 91-107.
- Narasimham KA (1996) Technology of mollusc culture. In: Krishnamoorthi B (ed.) *A Multibillion Dollar Industry: Proceedings of the Seminar on Fisheries*, pp. 105-110. Aquaculture Foundation of India & The Fisheries Technocrats Forum, Madras, India.
- Nell JA (1993) The development of oyster diets. *Australian Journal of Agricultural Research* 44: 557-566.
- Nell JA (2002) Farming triploid oysters. *Aquaculture* 210: 69-88.
- Nelson TC (1946) Circulation of embryos in the branchial chamber of *Ostrea cristata*. (ed.) *The Anatomical Record: 42nd Annual Meeting*, pp. 355-355. Wiley Company, Saint Louis, USA.
- Nelson TC, Allison JB (1940) On the nature and action of diantlin; a new hormone-like substance carried by the spermatozoa of the oyster. *Journal of Experimental Zoology* 85: 299-338.
- Newkirk GF (1980) Review of the genetics and the potential for selective breeding of commercially important bivalves. *Aquaculture* 19: 209-228.
- Newkirk GF (1986) Controlled mating of the European oyster, *Ostrea edulis*. *Aquaculture* 57: 111-116.
- Newkirk GF, Haley LE (1982) Progress in selection for growth rate in the European oyster *Ostrea edulis*. *Marine Ecology Progress Series* 10: 77-79.
- Newkirk RE, Muise BC, Enright CE (1995) Culture of the Belon oyster, *Ostrea edulis*, in Nova Scotia. In: Boghen AD (ed.) *Cold-Water Aquaculture in Atlantic Canada*, pp. 227-253. The Canadian Institute for Research on Regional Development, Sackville, Canada.
- Nielsen M, Hansen BW, Vismann B (2016) Feeding traits of the European flat oyster, *Ostrea edulis*, and the invasive Pacific oyster, *Crassostrea gigas*. *Marine Biology* 164: 6.
- Norkko J, Shumway SE (2011) Bivalves as bioturbators and bioirrigators. In: Shumway SE (ed.) *Shellfish Aquaculture and the Environment*, pp. 297-317. John Wiley & Sons, Inc., Oxford, UK.
- Ó Foighil D (1989) Role of spermatozeugmata in the spawning ecology of the brooding oyster *Ostrea edulis*. *Molecular Reproduction and Development* 24: 219-228.
- Ogle JT (1982) Operation of an oyster hatchery utilizing a brown water culture technique. *Journal of Shellfish Research* 2: 153-156.
- Olson RR, Olson MH (1989) Food limitation of planktotrophic marine invertebrate larvae: does it control recruitment success? *Annual Review of Ecology and Systematics* 20: 225-247.
- Orton JH (1920) Sea-temperature, breeding and distribution in marine animals. *Journal of the Marine Biological Association of the United Kingdom* 12: 339-366.

- Orton JH (1921) An oyster spat (1921) with mature male sexual products. *Nature* 108: 500.
- Orton JH (1924) Sex change and breeding in the native oyster, *Ostrea edulis*. *Nature* 114: 191-192.
- Orton JH (1926) On lunar periodicity in spawning of normally grown Falmouth Oysters (*O. edulis*) in 1925, with a comparison of the spawning capacity of normally grown and dumpy Oysters. *Journal of the Marine Biological Association of the United Kingdom* 14: 199-225.
- Orton JH (1927) Observation and experiments on sex-change in the European Oyster (*O. edulis*): Part I. The Change from female to male. *Journal of the Marine Biological Association of the United Kingdom* 14: 967-1045.
- Orton JH (1933) Observations and experiments on sex-change in the European oyster (*O. edulis*). Part III. On the fate of unspawned ova. Part IV. On the change from male to female. *Journal of the Marine Biological Association of the United Kingdom* 19: 1-53.
- Orton JH (1936) Observation and experiments on sex-change in the European Oyster (*O. edulis*): Part V. A simultaneous study of spawning in 1927 in two distinct geographical localities. (ed.) *Mémoires du Musée Royal d'Histoire Naturelle de Belgique*, pp. 997-1056, Bruxelles, Belgium.
- Orton JH (1937) *Oyster Biology and Oyster Culture: being the Buckland Lectures for 1935*, Edward Arnold & Company, London, UK.
- Orton JH, Amirthalingam C (1931) Observations and experiments on sex-change in the European oyster (*O. edulis*). Part II. On the gonad of egg-spawning individuals. *Journal of the Marine Biological Association of the United Kingdom* 17: 315-324.
- Oshino A, Seki T (1992) Temperature requirements of the French oyster, *Ostrea edulis* for gonad development and larval swarming in the Japanese water. *Aquaculture Science* 40: 347-353.
- Paillard C, Le Roux F, Borrego JJ (2004) Bacterial disease in marine bivalves, a review of recent studies: trends and evolution. *Aquatic Living Resources* 17: 477-498.
- Parisi G, Centoducati G, Gasco L, Gatta PP, Moretti VM, Piccolo G, Roncarati A, Terova G, Pais A (2012) Molluscs and echinoderms aquaculture: biological aspects, current status, technical progress and future perspectives for the most promising species in Italy. *Italian Journal of Animal Science* 11: 397-413.
- Partensky F, Vaulot D (1989) Cell size differentiation in the bloom-forming dinoflagellate *Gymnodinium* CF. *Nagasakiense*. *Journal of Phycology* 25: 741-750.
- Pascual M, Martin AG, Zampatti E, Coatanea D, Defossez J, Robert R (1991) Testing of the Argentina oyster, *Ostrea puelchana*, in several French oyster farming sites. *ICES CM Document K:30*, pp. International Council for the Exploration of the Sea, Copenhagen, Denmark.
- Pekala A, Pazdzior E (2012) Marteiliiosis of oysters - an invasive disease of molluscs. *Medycyna Weterynaryjna* 68: 728-731.
- Perusko GH (1969) The effects of several environmental factors on the spawning cycle of *Ostrea edulis* in the North Adriatic. *Thalassia Jugoslavica* 6: 91-99.
- Perusko GH (1970) Laboratory experiments on the effects of water temperature, water salinity and light intensity on the spawning and sexual development of mature oysters *Ostrea edulis* in Limski Kanal. *Thalassia Jugoslavica* 6: 91-99.
- Piazza BP, Piehler MK, Gossman BP, La Peyre MK, La Peyre JF (2009) Oyster recruitment and growth on an electrified artificial reef structure in Grand Isle, Louisiana. *Bulletin of Marine Science* 84: 59-66.
- Plunket L, Hidu H (1978) The role of *Uronema marinum* (Protozoa) in oyster hatchery production. *Aquaculture* 15: 219-225.
- Porsby CH, Gram L (2016) *Phaeobacter inhibens* as biocontrol agent against *Vibrio vulnificus* in oyster models. *Food Microbiology* 57: 63-70.
- Pouvreau B (1977) L'huître plate *Ostrea edulis* L : maturité sexuelle contrôlée, élevage larvaire, croissance et mortalité, variabilité génétique [The flat oyster *Ostrea edulis* L: controlled sexual maturity, larval rearing, growth and mortality, genetic variability], Publisher, PhD/Dr Thesis. CNEXO/University of Caen, France.
- Powers SP, Peterson CH, Grabowski JH, Lenihan HS (2009) Success of constructed oyster reefs in no-harvest sanctuaries: implications for restoration. *Marine Ecology Progress Series* 389: 159-170.
- Prado-Alvarez M, Lynch SA, Kane A, Darmody G, Pardo BG, Martínez P, Cotterill J, Wontner-Smith T, Culloty SC (2015) Oral immunostimulation of the oyster *Ostrea edulis*: impacts on the parasite *Bonamia ostreae*. *Fish & Shellfish Immunology* 45: 43-51.
- Prado P, Roque A, Pérez J, Ibáñez C, Alcaraz C, Casals F, Caiola N (2016) Warming and acidification-mediated resilience to bacterial infection determine mortality of early *Ostrea edulis* life stages. *Marine Ecology Progress Series* 545: 189-202.
- Prado S, Montes J, Romalde JL, Barja JL (2009) Inhibitory activity of *Phaeobacter* strains against aquaculture pathogenic bacteria. *International Microbiology* 12: 107-114.



- Prado S, Romalde JL, Barja JL (2010) Review of probiotics for use in bivalve hatcheries. *Veterinary Microbiology* 145: 187-197.
- Prado S, Romalde JL, Montes J, Barja JL (2005) Pathogenic bacteria isolated from disease outbreaks in shellfish hatcheries. First description of *Vibrio neptunius* as an oyster pathogen. *Diseases of Aquatic Organisms* 67: 209-215.
- Prieur D (1981) Les relations entre mollusques bivalves et bacteries heterotrophes en milieu marin [The relationship between bivalve molluscs and heterotrophic bacteria in the marine environment], Publisher, PhD/Dr Thesis. University of Brest, France.
- Prytherch HF (1924) Experiments in the artificial propagation of oysters. In: O'Malley H (ed.) *Report of the United States Commissioner of Fisheries for the Fiscal Year 1923*, pp. 1-14, Washington, USA.
- Qiu T, Qi J, Zheng J, Liu Y (2017) Design and performance of a recirculating aquaculture system for oyster larval culture. *Aquaculture Research* 48: 1-8.
- Rajagopal S, van der Velde G (2012) Invasive species: implications for industrial cooling water systems. In: Rajagopal S, Jenner HA, Venugopalan VP (ed.) *Operational and Environmental Consequences of Large Industrial Cooling Water Systems*, pp. 127-162. Springer US, Boston, MA.
- Redant F (1997) The Belgian mollusk fisheries. In: MacKenzie CL, Burrell VG, Rosenfield A, Hobart WL (ed.) *The History, Present Condition, and Future of the Molluscan Fisheries of North and Central America and Europe*, pp. 101-114. Scientific Publications Office, NMFS, NOAA, Seattle, USA.
- Renault T, Arzul I (2001) Herpes-like virus infections in hatchery-reared bivalve larvae in Europe: specific viral DNA detection by PCR. *Journal of Fish Diseases* 24: 161-167.
- Renault T, Le Deuff RM, Chollet B, Cochenne N, Gérard A (2000) Concomitant herpes-like virus infections in hatchery-reared larvae and nursery-cultured spat *Crassostrea gigas* and *Ostrea edulis*. *Diseases of Aquatic Organisms* 42: 173-183.
- Renzoni A (1973) The influence of some detergents on the larval life of marine bivalve larvae. In: Genovese S (ed.) *Proceedings of the 5th International Colloquium of Medical Oceanography*, pp. 101-104. University of Messina, Messina, Italy.
- Rice MA, Wallis K, Stephens GC (1980) Influx and net flux of amino acids into larval and juvenile European flat oysters, *Ostrea edulis* (L.). *Journal of Experimental Marine Biology and Ecology* 48: 51-59.
- Richardson CA, Collis SA, Ekaratne K, Dare P, Key D (1993) The age determination and growth rate of the European flat oyster, *Ostrea edulis*, in British waters determined from acetate peels of umbo growth lines. *ICES Journal of Marine Science* 50: 493-500.
- Rico-Villa B, Woerther P, Mingant C, Lepiver D, Pouvreau S, Hamon M, Robert R (2008) A flow-through rearing system for ecophysiological studies of Pacific oyster *Crassostrea gigas* larvae. *Aquaculture* 282: 54-60.
- Ridler N, Roderick W (1991) Financial feasibility and farm systems in cultivating *ostrea edulis*. *Journal of Shellfish Research* 10: 395-398.
- Robert R, Borel M, Pichot Y, Trut G (1991) Growth and mortality of the European oyster *Ostrea edulis* in the Bay of Arcachon (France). *Aquatic Living Resources* 4: 265-274.
- Robert R, Chretiennot-Dinet MJ, Kaas R, Martin-Jezequel V, Moal J, Le Coz JR, Nicolas JL, Bernard E, Connan JP, Le Dean L, Le Gourrierec G, Leroy B, Quere C (2004) Amélioration des productions phytoplanctoniques en éclosérie de mollusques : caractérisation des microalgues fourrage [Improvement of phytoplankton culture in mollusc hatcheries: characterisation of microalgae used as aquaculture feeds]. (ed.) *IFREMER Report DRV/RA/RST/LPI/2004-05*, pp. 1-145. French Research Institute for Exploitation of the Sea, Argenton, France.
- Robert R, Gérard A (1999) Bivalve hatchery technology: the current situation for the Pacific oyster *Crassostrea gigas* and the scallop *Pecten maximus* in France. *Aquatic Living Resources* 12: 121-130.
- Robert R, His E (1985) Croissance et spectre de tailles de six algues utilisées pour la nutrition de larves de bivalves en éclosérie, en culture non renouvelée [Growth and size frequency distribution of six marine unicellular algae in batch cultures used as food for larvae of bivalve molluscs]. *Revue des Travaux de l'Institut des Pêches Maritimes* 49: 165-173.
- Robert R, His E, Dinet A (1988) Combined effects of temperature and salinity on fed and starved larvae of the European flat oyster *Ostrea edulis*. *Marine Biology* 97: 95-100.
- Robert R, Trintignac P (1997a) Microalgues et nutrition larvaire en éclosérie de mollusques [Microalgae and larval feeding in mollusc hatchery]. *Haliotis* 26: 1-13.
- Robert R, Trintignac P (1997b) Substitutes for live microalgae in mariculture: a review. *Aquatic Living Resources* 10: 315-327.
- Robert R, Vignier J, Petton B (2017) Influence of feeding regime and temperature on development and settlement of oyster *Ostrea edulis* (Linnaeus, 1758) larvae. *Aquaculture Research* 48: 1-18.

- Roché G (1898) *La Culture des Mers en Europe : Piscifaculture - Pisciculture - Ostréiculture*, Félix Alcan, Editeur, Paris, France.
- Rodhouse PG, O'Kelly M (1981) Flow requirements of the oysters *Ostrea edulis* L. and *Crassostrea gigas* Thunb. in an upwelling column system of culture. *Aquaculture* 22: 1-10.
- Rodhouse PG, Roden C, Somerville-Jacklin ME (1983) Nutritional value of micro-algal mass cultures to the oyster *Ostrea edulis* L. *Aquaculture* 32: 11-18.
- Rödström EM (1989) Do oysters get cold feet in Sweden? A preliminary report on winter tolerance of *Ostrea edulis*, Linné, from the Swedish west coast. In: De Pauw N, Jaspers E, Ackefors H, Wilkins N (ed.) *Aquaculture: a Biotechnology in Progress: Proceedings of the International Conference Aquaculture Europe*, pp. 361-361. European Aquaculture Society, Bredene, Belgium.
- Rödström EM, Jonsson PR (2000) Survival and feeding activity of oyster spat (*Ostrea edulis* L.) as a function of temperature and salinity with implications for culture policies on the Swedish west coast. *Journal of Shellfish Research* 19: 799-808.
- Rogan E, Cross TF (1996) Nutrient dynamics and plankton cycles in artificial ponds used in the production of oyster *Ostrea edulis* L. spat. *Aquaculture Research* 27: 9-23.
- Ronquillo JD, Fraser J, McConkey AJ (2012) Effect of mixed microalgal diets on growth and polyunsaturated fatty acid profile of European oyster (*Ostrea edulis*) juveniles. *Aquaculture* 360: 64-68.
- Ronza P, Cao A, Robledo D, Gomez-Tato A, Alvarez-Dios JA, Hasanuzzaman AFM, Quiroga MI, Villalba A, Pardo BG, Martinez P (2018) Long-term affected flat oyster (*Ostrea edulis*) haemocytes show differential gene expression profiles from naive oysters in response to *Bonamia ostreae*. *Genomics* 110: 390-398.
- Rosell D, Uriz MJ, Martin D (1999) Infestation by excavating sponges on the oyster (*Ostrea edulis*) populations of the Blanes littoral zone (north-western Mediterranean Sea). *Journal of the Marine Biological Association of the United Kingdom* 79: 409-413.
- Rosique MJ, Cano J (1999) Culture of European flat oyster (*Ostrea edulis*) spat in a pond with gilthead seabream (*Sparus aurata*). *Iberus* 17: 91-105.
- Rowley AF, Cross ME, Culloty SC, Lynch SA, Mackenzie CL, Morgan E, O'Riordan RM, Robins PE, Smith AL, Thrupp TJ, Vogan CL, Wootton EC, Malham SK (2014) The potential impact of climate change on the infectious diseases of commercially important shellfish populations in the Irish Sea - a review. *ICES Journal of Marine Science* 71: 741-759.
- Ruano FDL (1997) Fisheries and farming of important marine bivalves in Portugal. In: MacKenzie CL, Burrell VG, Rosenfield A, Hobart WL (ed.) *The History, Present Condition, and Future of the Molluscan Fisheries of North and Central America and Europe*, pp. 191-200. Scientific Publications Office, NMFS, NOAA, Seattle, USA.
- Ruesink JL, Lenihan HS, Trimble AC, Heiman KW, Micheli F, Byers JE, Kay MC (2005) Introduction of non-native oysters: ecosystem effects and restoration implications. *Annual Review of Ecology and Systematics* 36: 643-689.
- Ruiz C, Martinez D, Mosquera G, Abad M, Sánchez JL (1992) Seasonal variations in condition, reproductive activity and biochemical composition of the flat oyster, *Ostrea edulis*, from San Cibrán (Galicia, Spain). *Marine Biology* 112: 67-74.
- Saavedra C (1997) Low effective sizes in hatchery populations of the European oyster (*Ostrea edulis*): implications for the management of genetic resources. *Journal of Shellfish Research* 16: 441-446.
- Saavedra C, Zapata C, Alvarez G (1995) Geographical patterns of variability at allozyme loci in the European oyster *Ostrea edulis*. *Marine Biology* 122: 95-104.
- Sale JW, Skinner WW (1917) The vertical distribution of dissolved oxygen and the precipitation by salt water in certain tidal areas. *Journal of The Franklin Institute* 184: 837-848.
- Samain JF, Saout C, Soudant P, Le Coz JR, Segueineau C, Queré C, Connan JP, Mazuret M, Miner P, Muzellec ML, Marty Y, Moal J, Paulet YM, Robert R (1997) Nutrition et reproduction des bivalves [Nutrition and reproduction of bivalves]. In: Devauchelle N, Barret J, Salaun G (ed.) *The Natural and Controlled Reproduction of Cultivated Bivalves in France: Symposium Report*, pp. 137-148. IFREMER, Nantes, France.
- Sarkis S, Lovatelli A (2007) Algal cultures: facilities and techniques. In: Sarkis S, Lovatelli A (ed.) *Installation and Operation of a Modular Bivalve Hatchery*, pp. 37-58. Food and Agriculture Organization of the United Nations, Rome, Italy.
- Sawusdee A (2015) Restoration of the European flat oyster *Ostrea edulis* using elevated broodstock reefs, Publisher, PhD Thesis. University of Southampton, UK.
- Sawusdee A, Jensen AC, Collins KJ, Hauton C (2015) Improvements in the physiological performance of European flat oysters *Ostrea edulis* (Linnaeus, 1758) cultured on elevated reef structures: implications for oyster restoration. *Aquaculture* 444: 41-48.

- Seaman MNL, Ruth M (1997) The molluscan fisheries of Germany. In: MacKenzie CL, Burrell VG, Rosenfield A, Hobart WL (ed.) *The History, Present Condition, and Future of the Molluscan Fisheries of North and Central America and Europe*, pp. 57-84. Scientific Publications Office, NMFS, NOAA, Seattle, USA.
- Sheldon RW (1968) The effect of high population density on the growth and mortality of oysters (*Ostrea edulis*). *ICES Journal of Marine Science* 31: 352-363.
- Sheridan AK (1997) Genetic improvement of oyster production - a critique. *Aquaculture* 153: 165-179.
- Shpigel M (1989) Gametogenesis of the European flat oyster (*Ostrea edulis*) and Pacific oyster (*Crassostrea gigas*) in warm water in Israel. *Aquaculture* 80: 343-349.
- Shpigel M, Coon SL, Kleinot P (1989) Growth and survival of cultchless spat of *Ostrea edulis* Linnaeus, 1750 produced using epinephrine and shell chips. *Journal of Shellfish Research* 8: 355-357.
- Shumway SE (1990) A review of the effects of algal blooms on shellfish and aquaculture. *Journal of the World Aquaculture Society* 21: 65-104.
- Shumway SE, Cucci TL, Newell RC, Yentsch CM (1985) Particle selection, ingestion, and absorption in filter-feeding bivalves. *Journal of Experimental Marine Biology and Ecology* 91: 77-92.
- Skaramuca B, Teskeredžić E, Teskeredžić Z (1997) Mariculture in Croatia, history and perspectives. *Ribarstvo* 55: 19-26.
- Smith IP, Low PJ, Moore PG (2006) Legal aspects of conserving native oysters in Scotland. *Marine Pollution Bulletin* 52: 479-483.
- Smolowitz R, Shumway SE (1997) Possible cytotoxic effects of the dinoflagellate, *Gyrodinium aureolum*, on juvenile bivalve molluscs. *Aquaculture International* 5: 291-300.
- Smyth D, Kregting L, Elsässer B, Kennedy R, Roberts D (2016) Using particle dispersal models to assist in the conservation and recovery of the overexploited native oyster (*Ostrea edulis*) in an enclosed sea lough. *Journal of Sea Research* 108: 50-59.
- Smyth D, Mahon AM, Roberts D, Kregting L (2018) Settlement of *Ostrea edulis* is determined by the availability of hard substrata rather than by its nature: Implications for stock recovery and restoration of the European oyster. *Aquatic Conservation: Marine and Freshwater Ecosystems* 28: 1-10.
- Smyth D, Roberts D (2010) The European oyster (*Ostrea edulis*) and its epibiotic succession. *Hydrobiologia* 655: 25-36.
- Smyth D, Roberts D, Browne L (2009) Impacts of unregulated harvesting on a recovering stock of native oysters (*Ostrea edulis*). *Marine Pollution Bulletin* 58: 916-922.
- Sobolewska H, Beaumont AR (2005) Genetic variation at microsatellite loci in northern populations of the European flat oyster (*Ostrea edulis*). *Journal of the Marine Biological Association of the United Kingdom* 85: 955-960.
- Soletchnik P, Le Moine O, Gouletquer P, Geairon P, Razet D, Faury N, Fouché D, Robert S (2001) Optimisation of the traditional Pacific cupped oyster (*Crassostrea gigas* Thunberg) culture on the French Atlantic coastline: autumnal fattening in semi-closed ponds. *Aquaculture* 199: 73-91.
- Song SL, Li Q, Kong LF (2011) Larval growth and survival of hybrid between different geographic populations of Pacific oyster *Crassostrea gigas*. *Periodical of Ocean University of China* 12: 1-10.
- Spärck R (1922) The conditions of sex-change in the oyster (*Ostrea edulis*). *Nature* 110: 480-480.
- Spärck R (1925) Studies on the biology of oyster (*Ostrea edulis*) in the Limfjord, with special reference to the influence of temperature on the sex change. In: Petersen CGJ (ed.) *Report of the Danish Biological Station to the Board of Agriculture*, pp. 1-84, Copenhagen, Denmark.
- Spencer BE (1988) Growth and filtration of juvenile oysters in experimental outdoor pumped upwelling systems. *Aquaculture* 75: 139-158.
- Spencer BE (2008) *Molluscan Shellfish Farming*, Fishing News Books, Blackwell Publishing, Oxford, UK.
- Spencer BE, Akester M, Mayer I (1986) Growth and survival of seed oysters in outdoor pumped upwelling systems supplied with fertilized sea water. *Aquaculture* 55: 173-189.
- Spencer BE, Gough CJ (1978) The growth and survival of experimental batches of hatchery-reared spat of *Ostrea edulis* L. and *Crassostrea gigas* Thunberg, using different methods of tray cultivation. *Aquaculture* 13: 293-312.
- Stanley JG, Allen SK, Hidu H (1981) Polyploidy induced in the American oyster, *Crassostrea virginica*, with cytochalasin B. *Aquaculture* 23: 1-10.
- Staykov Y (1997) Mollusk fisheries in Bulgaria. In: MacKenzie CL, Burrell VG, Rosenfield A, Hobart WL (ed.) *The History, Present Condition, and Future of the Molluscan Fisheries of North and Central America and Europe*, pp. 233-240. Scientific Publications Office, NMFS, NOAA, Seattle, USA.
- Strand Ø (1996) Enhancement of bivalve production capacity in a landlocked heliothermic marine basin. *Aquaculture Research* 27: 355-373.

- Strand Ø, Solberg PT, Magnesen T (1996) Nitrogen conversion in a bivalve culture system. *Journal of the Marine Biological Association of the United Kingdom* 76: 57-72.
- Strand Ø, Vølstad JH (1997) The molluscan fisheries and culture of Norway. In: MacKenzie CL, Burrell VG, Rosenfield A, Hobart WL (ed.) *The History, Present Condition, and Future of the Molluscan Fisheries of North and Central America and Europe*, pp. 7-24. Scientific Publications Office, NMFS, NOAA, Seattle, USA.
- Sühnel S, Picanço T, Medeiros SC, Rachelmagentamagalhães A, Demelo CR (2017) Effects of seeding date and seed size on *Crassostrea gigas* (Thunberg, 1793) culture in a subtropical climate. *Journal of Shellfish Research* 36: 303-313.
- Supan J (2014) High-density rearing of oyster larvae in flow-through systems. (ed.) *SRAC Publication 4311*, pp. 1-6. Southern Regional Aquaculture Center, Stoneville, USA.
- Suquet M, González-Araya R, Lebrun L, Queau I, Mingant C, Robert R (2010) Anaesthesia and gonad sampling in the European flat oyster (*Ostrea edulis*). *Aquaculture* 308: 196-198.
- Suquet M, Pouvreau S, Queau I, Boulais M, Le Grand J, Ratiskol D, Cosson J (2018) Biological characteristics of sperm in European flat oyster (*Ostrea edulis*). *Aquatic Living Resources* 31: 1-7.
- Suquet M, Queau I, Le Grand J, Ratiskol D, Pouvreau S (2017) Caractéristiques biologiques des gamètes et larves d'huître plate européenne (*Ostrea edulis*) : données préliminaires [Biological characteristics of gametes and larvae in European flat oyster (*Ostrea edulis*): preliminary data]. (ed.) *IFREMER Report R.INT/RBE/PFOM/LPI*, pp. 1-21. French Research Institute for Exploitation of the Sea, Station d'Argenton, France.
- Takeda K (1974) The food effects of three unicellular algae for larval oyster *Ostrea edulis* L. in the Laboratory. *La Mer* 12: 59-65.
- Takeuchi T (2017) Molluscan genomics: implications for biology and aquaculture. *Current Molecular Biology Reports* 3: 297-305.
- Tanaka S, Sato A, Kawamura K, Naoe H (1976) ヨーロッパヒラガキの人工採苗-採苗器の改良について- [On the improvement of collectors in the artificial propagation of European flat oyster, *Ostrea edulis* L]. *Aquaculture Science* 23: 135-138.
- Taris N, Boudry P, Bonhomme F, Camara MD, Lapègue S (2009) Mitochondrial and Nuclear DNA analysis of genetic heterogeneity among recruitment cohorts of the European flat oyster *Ostrea edulis*. *The Biological Bulletin* 217: 233-241.
- Thain JE, Waldock MJ (1986) The impact of tributyl tin (TBT) antifouling paints on molluscan fisheries. *Water Science and Technology* 18: 193-202.
- Theede H, Ponat A, Hiroki K, Schlieper C (1969) Studies on the resistance of marine bottom invertebrates to oxygen-deficiency and hydrogen sulphide. *Marine Biology* 2: 325-337.
- Thenepalli T, Ramakrishna C, Ahn JW (2017) Environmental effect of the coffee waste and antimicrobial property of oyster shell waste treatment. *Journal of Energy Engineering* 26: 39-49.
- Thompson JR, Pacocha S, Pharino C, Klepac-Ceraj V, Hunt DE, Benoit J, Sarma-Rupavtarm R, Distel DL, Polz MF (2005) Genotypic diversity within a natural coastal bacterioplankton population. *Science* 307: 1311-1313.
- Thorson G (1950) Reproductive and larval ecology of marine bottom invertebrates. *Biological Reviews* 25: 1-45.
- Thurstan RH, Hawkins JP, Raby L, Roberts CM (2013) Oyster (*Ostrea edulis*) extirpation and ecosystem transformation in the Firth of Forth, Scotland. *Journal for Nature Conservation* 21: 253-261.
- Tibabuzo Perdomo AM, Alberts EM, Taylor SD, Sherman DM, Huang CP, Wilker JJ (2018) Changes in cementation of reef building oysters transitioning from larvae to adults. *ACS Applied Materials & Interfaces* 10: 14248-14253.
- Todorova V, Micu D, Klisurov L (2009) Unique oyster reefs discovered in the Bulgarian Black Sea. *Proceedings of the Bulgarian Academy of Sciences* 62: 871-874.
- Toro JE, Newkirk GF (1990) Divergent selection for growth rate in the European oyster *Ostrea edulis*: response to selection and estimation of genetic parameters. *Marine Ecology Progress Series* 62: 219-227.
- Travers MA, Boettcher Miller K, Roque A, Friedman CS (2015) Bacterial diseases in marine bivalves. *Journal of Invertebrate Pathology* 131: 11-31.
- Tritar S, Prieur D, Weiner R (1992) Effects of bacterial films on the settlement of oysters, *Crassostrea gigas* (Thunberg, 1793) and *Ostrea edulis* Linnaeus, 1750, and the scallop, *Pecten maximus* (Linnaeus, 1758). *Journal of Shellfish Research* 11: 325-330.
- Trochon P (1956) Etude sur la reproduction de l'huître plate *Ostrea edulis* dans les claires de la région Marennes-Oléron [Study on the reproduction of the flat oyster *Ostrea edulis* in the ponds of the

- Marenes-Oléron region]. *ICES Marine Science Symposia. Volume 140-3*, pp. 14-16. International Council for the Exploration of the Sea, Copenhagen, Denmark.
- Tubiash HS, Chanley PE, Leifson E (1965) Bacillary necrosis, a disease of larval and juvenile bivalve mollusks. I. Etiology and epizootiology. *Journal of Bacteriology* 90: 1036-1044.
- Tully O, Clarke S (2012) The status and management of oyster (*Ostrea edulis*) in Ireland. (ed.) *Irish Fisheries Investigations* 24, pp. 1-40. Marine Institute, Galway, Ireland.
- Turcotte F, Mouget JL, Genard B, Lemarchand K, Deschênes JS, Tremblay R (2016) Prophylactic effect of *Haslea ostrearia* culture supernatant containing the pigment marennine to stabilize bivalve hatchery production. *Aquatic Living Resources* 29: 1-9.
- Ulvestad KB, Strand Ø (1997) Modelling hydrography and algal production in a poll in western Norway. *Ecological Modelling* 101: 285-301.
- Utting SD (1988) The growth and survival of hatchery-reared *Ostrea edulis* L. spat in relation to environmental conditions at the on-growing site. *Aquaculture* 69: 27-38.
- Utting SD, Helm M (1985) Improvement of sea water quality by physical and chemical pre-treatment in a bivalve hatchery. *Aquaculture* 44: 133-144.
- Utting SD, Helm MM, Millican PF (1991) Recent studies on the fecundity of European flat oyster (*Ostrea edulis*) spawning stock in the solent. *Journal of the Marine Biological Association of the United Kingdom* 71: 909-911.
- Utting SD, Millican PF (1997) Techniques for the hatchery conditioning of bivalve broodstocks and the subsequent effect on egg quality and larval viability. *Aquaculture* 155: 45-54.
- Utting SD, Millican PF (1998) The role of diet in hatchery conditioning of *Pecten maximus* L.: a review. *Aquaculture* 165: 167-178.
- Uyan O, Aral O (2000) A study on the possibilities of obtaining larva from native flat oysters (*Ostrea edulis* L.) living in the Black Sea and larval metamorphosis stage. *Turkish Journal of Zoology* 24: 343-350.
- Vallauri DR, Aronson J, Barbero M (2002) An analysis of forest restoration 120 years after reforestation on Badlands in the Southwestern Alps. *Restoration Ecology* 10: 16-26.
- van Banning P (1977) *Minchinia armoricana* sp. nov. (Haplosporida), a parasite of the European flat oyster, *Ostrea edulis*. *Journal of Invertebrate Pathology* 30: 199-206.
- van Banning P (1979) Haplosporidian diseases of imported oysters, *Ostrea edulis*, in Dutch estuaries. *Marine Fisheries Review* 41: 8-18.
- van den Brink A (2012) The efficiency of different types of oyster spat collectors for *Ostrea edulis*. (ed.) *Oysterecover EU FP7 Report*, pp. 1-33. Institute for Marine Resources & Ecosystem Studies, Wageningen UR, The Netherlands.
- Ver LMB, Wang JK (1995) Design criteria of a fluidized bed oyster nursery. *Aquacultural Engineering* 14: 229-249.
- Vera M, Carlsson J, Carlsson JEL, Cross T, Lynch S, Kamermans P, Villalba A, Culloty S, Martinez P (2016) Current genetic status, temporal stability and structure of the remnant wild European flat oyster populations: conservation and restoring implications. *Marine Biology* 163: 1-17.
- Vercaemer B, Spence K, Roach S, MacDonald B, Kenchington E, Mallet A (2004) Towards a better understanding of European oyster *Ostrea edulis* breeding: results of the 2003-2004 ACRDP project. (ed.) *Canadian Technical Report of Fisheries and Aquatic Sciences* 2563, pp. 1-42. Department of Fisheries and Oceans, Canada.
- Vercaemer B, Spence KR, Herbinger CM, Lapègue S, Kenchington EL (2006) Genetic diversity of the European oyster (*Ostrea edulis* L.) in Nova Scotia: comparison with other parts of Canada, Maine and Europe and implications for broodstock management. *Journal of Shellfish Research* 25: 543-551.
- Vercelli C, Coatanéa D, Chabirand JM, Oheix J (1997) Contrôle de la gamétogenèse d'un stock d'huîtres plates méditerranéennes *Ostrea edulis* [Control of the gametogenesis of a Mediterranean flat oyster stock *Ostrea edulis*]. In: Devauchelle N, Barret J, Salaun G (ed.) *The Natural and Controlled Reproduction of Cultivated Bivalves in France: Symposium Report*, pp. 91-98. IFREMER, Nantes, France.
- Vercelli C, Oheix J, Chabirand JM, Pichot Y, Buestel D (2000) Programme de diversification des productions conchylicoles en Languedoc Roussillon - Projet Huître plate *Ostrea edulis* : Rapport final [Program to diversify shellfish production in Languedoc Roussillon - Project Flat Oyster *Ostrea edulis*: final report]. (ed.) *IFREMER Report UE/PESCA*, pp. 1-65. French Research Institute for Exploitation of the Sea, Palavas-les-Flots, France.
- Virvilis C, Angelidis P (2006) Presence of the parasite *Marteilia* sp. in the flat oyster (*Ostrea edulis* L.) in Greece. *Aquaculture* 259: 1-5.

- Vitiello V, Carlino PA, Del Prete F, Langellotti AL, Sansone G (2011) Effects of cooling and freezing on the motility of *Ostrea edulis* (L., 1758) spermatozoa after thawing. *Cryobiology* 63: 118-124.
- Voultsiadou E, Koutsoubas D, Achparaki M (2010) Bivalve mollusc exploitation in Mediterranean coastal communities: an historical approach. *Journal of Biological Research-Thessaloniki* 13: 35-45.
- Wallace RK, Waters P, Rikard FS (2008) Oyster hatchery techniques. (ed.) *SRAC Publication 4302*, pp. 1-6. Southern Regional Aquaculture Center, Stoneville, USA.
- Waller TR (1981) Functional morphology and development of veliger larvae of the European oyster, *Ostrea edulis* Linné. In: Waller TR (ed.) *Smithsonian Contribution to Zoology* 328, pp. 1-80. Smithsonian Institution Press, Washington, USA.
- Walne PR (1956a) Destruction of competitive organisms on artificial oyster-spat collectors. *ICES Journal of Marine Science* 22: 75-76.
- Walne PR (1956b) Experimental rearing of the larvae of *Ostrea edulis* L. in the laboratory. (ed.) *Fishery Investigations Series II*, pp. 1-28. Her Majesty's Stationery Office, London, UK.
- Walne PR (1956c) Observations on the oyster (*Ostrea edulis*) breeding experiments at Conway, 1939-1953. *ICES Marine Science Symposia. Volume 140-3*, pp. 10-13. International Council for the Exploration of the Sea, Copenhagen, Denmark.
- Walne PR (1958) The importance of bacteria in laboratory experiments on rearing the larvae of *Ostrea edulis* (L.). *Journal of the Marine Biological Association of the United Kingdom* 37: 415-425.
- Walne PR (1963) Observations on the food value of seven species of algae to the larvae of *Ostrea edulis* L. feeding experiments. *Journal of the Marine Biological Association of the United Kingdom* 43: 767-784.
- Walne PR (1964) Observations on the fertility of the oyster (*Ostrea edulis*). *Journal of the Marine Biological Association of the United Kingdom* 44: 293-310.
- Walne PR (1965) Observations on the influence of food supply and temperature on the feeding and growth of the larvae of *Ostrea edulis* L. (ed.) *Fishery Investigations Series II*, pp. 1-47. Her Majesty's Stationery Office, London, UK.
- Walne PR (1970a) Present problems in the culture of the larvae of *Ostrea edulis*. *Helgoländer Wissenschaftliche Meeresuntersuchungen* 20: 514-525.
- Walne PR (1970b) Studies on the food value of nineteen genera of algae to juvenile bivalves of the genera *Ostrea*, *Crassostrea*, *Mercenaria* and *Mytilus*. (ed.) *Fishery Investigations Series II*, pp. 1-66. Her Majesty's Stationery Office, London, UK.
- Walne PR (1974) *Culture of Bivalve Molluscs: 50 Years Experience at Conwy*, Fishing News Books Limited, Surrey, UK.
- Walne PR, Spencer BE (1974) Experiments on the growth and food conversion efficiency of the spat of *Ostrea edulis* L in a recirculation system. *ICES Journal of Marine Science* 35: 303-318.
- Waugh GD (1964) Observations on the effects of chlorine on the larvae of oysters (*Ostrea edulis* (L.)) and barnacles (*Elminius modestus* (Darwin)). *Annals of Applied Biology* 54: 423-440.
- Waugh GD, Ansell A (1956) The effect, on oyster spatfall, of controlling barnacle settlement with DDT. *Annals of Applied Biology* 44: 619-625.
- Webster D (2011) Education. In: Shumway SE (ed.) *Shellfish Aquaculture and the Environment*, pp. 447-459. John Wiley & Sons, Inc., Oxford, UK.
- Weiner RM, Coyne VE, Brayton P, West P, Raiken SF (1988) *Alteromonas colwelliana* sp. nov., an isolate from oyster habitats. *International Journal of Systematic and Evolutionary Microbiology* 38: 240-244.
- Wendling CC, Batista FM, Wegner KM (2014) Persistence, seasonal dynamics and pathogenic potential of *Vibrio* communities from Pacific oyster hemolymph. *PLOS One* 9: e94256.
- Wendling CC, Fabritzek AG, Wegner KM (2017) Population-specific genotype x genotype x environment interactions in bacterial disease of early life stages of Pacific oyster larvae. *Evolutionary Applications* 10: 338-347.
- Wendling CC, Wegner KM (2015) Adaptation to enemy shifts: rapid resistance evolution to local *Vibrio* spp. in invasive Pacific oysters. *Proceedings of the Royal Society B: Biological Sciences* 282: 20142244.
- Westley RE (1975) Past, present, and future trends in cultural techniques and oyster production in the state of Washington. *Proceedings of the Annual Meeting - World Mariculture Society* 6: 213-219.
- Wilde A (1985) The food of starfish *Asterias rubens* L. on cultivated and derelict oyster fisheries. *Irish Naturalists' Journal* 21: 528-532.
- Widdows J (1991) Physiological ecology of mussel larvae. *Aquaculture* 94: 147-163.
- Wilson JH (1978) The food value of *Phaeodactylum tricornutum* Bohlin to the larvae of *Ostrea edulis* L. and *Crassostrea gigas* Thunberg. *Aquaculture* 13: 313-323.

- Wilson JH (1979) Observations on the grazing rates and growth of *Ostrea edulis* L. larvae when fed algal cultures of different ages. *Journal of Experimental Marine Biology and Ecology* 38: 187-199.
- Wilson JH (1980) Particle retention and selection by larvae and spat of *Ostrea edulis* in algal suspensions. *Marine Biology* 57: 135-145.
- Wilson JH (1983) Retention efficiency and pumping rate of *Ostrea edulis* in suspensions of *Isochrysis galbana*. *Marine Ecology Progress Series* 12: 51-58.
- Wilson JH, Simons J (1985) Gametogenesis and breeding of *Ostrea edulis* on the west coast of Ireland. *Aquaculture* 46: 307-321.
- Xiao S, Yu ZN (2008) Review of selective breeding research and practice in oyster cultivation. *Journal of Fisheries of China* 32: 287-295.
- Yang H, Simon N, Sturmer L (2018) Production and performance of triploid oysters for aquaculture. (ed.) *UF/IFAS Extension FA208*, pp. Institute of Food and Agricultural Sciences, University of Florida, Gainesville, Florida.
- Yonge CM (1960) *Oysters*. *The New Naturalist*, Collins, London, UK.
- Zhang Y, Wang Z, Yan X, Yu R, Kong J, Liu J, Li X, Li Y, Guo X (2012a) Laboratory hybridization between two oysters: *Crassostrea gigas* and *Crassostrea hongkongensis*. *Journal of Shellfish Research* 31: 619-625.
- Zhang YH, Wang ZP, Yan XW, Yao T, Yu ZF, Huo ZM, Yu RH, Li XY, Li YL, Guo XM (2012b) Interspecific hybridization between two oysters *Crassostrea gigas* and *C. ariakensis*. *Journal of Fisheries of China* 36: 1215-1224.
- Zolotarev PN, Terentyev AS (2012) Changes in the macrobenthic communities of the Gudauta oyster bank. *Oceanology* 52: 231-237.
- Zwerschke N, Hollyman PR, Wild R, Strigner R, Turner JR, King JW (2018) Limited impact of an invasive oyster on intertidal assemblage structure and biodiversity: the importance of environmental context and functional equivalency with native species. *Marine Biology* 165: 1-13.

### Appendix S3

Table of the breeding programme and production records from 1987 at Rossmore Breeding Ponds. Production is shown in the weight of marketable *O. edulis* (>75 g per oyster) actually sold. Data provided from Tristan Hugh-Jones.

Year	Origin of the <i>O. edulis</i> spat production	Generation F1	Generation F2	Generation F3	Generation F4	Generation F5	Generation F6
1987	Survivors	F1 spat	-	-	-	-	-
1988	Survivors	F1 spat	-	-	-	-	-
1989	Survivors	F1 spat	-	-	-	-	-
1990	Survivors	F1 spat	-	-	-	-	-
1991	F1 survivors	-	F2 spat	-	-	-	-
1992	F1 survivors	-	F2 spat	-	-	-	-

1993	F1 survivors	31,793 kg	F2 spat	-	-	-	-
1994	F1 survivors	34,207 kg	F2 spat	-	-	-	-
1995	F2 survivors	-	133,788 kg	F3 spat	-	-	-
1996	F2 survivors	-	119,765 kg	F3 spat	-	-	-
1997	F2 survivors	-	68,405 kg	F3 spat	-	-	-
1998	F2 survivors	-	64,617 kg	F3 spat	-	-	-
1999	F3 survivors	-	-	48,887 kg	F4 spat	-	-
2000	F3 survivors	-	-	72,420 kg	F4 spat	-	-
2001	F3 survivors	for 6 years	-	84,647 kg	F4 spat	-	-
2002	F3 survivors	Fishery closed	-	84,647 kg	F4 spat	-	-
2003	F4 survivors	Fishery closed	-	Stock survey	127,500 kg	F5 spat	-
2004	F4 survivors	Fishery closed	-	-	2 <sup>nd</sup> F4 sale	F5 spat	-
2005	F4 survivors	Fishery closed	-	-	3 <sup>rd</sup> F4 sale	F5 spat	-
2006	F4 survivors	Fishery closed	-	-	4 <sup>th</sup> F4 sale	F5 spat	-
2007	F4 survivors	Fishery closed	-	-	5 <sup>th</sup> F4 sale	F5 spat	-
2008	F5 survivors	Fishery closed	-	-	-	1 <sup>st</sup> F5 sale	-



2009	F5 survivors	Fishery closed	-	-	-	2 <sup>nd</sup> F5 sale	-
2010	F5 survivors	Fishery closed	-	-	-	3 <sup>rd</sup> F5 sale	-
2011	F5 survivors	Fishery closed	-	-	-	4 <sup>th</sup> F5 sale	F6 spat

---

**Appendix S4** Synthesis of chronological cryopreservation operations (1-5) of *O. edulis* sperm (spermatozeugmata) from Vitiello *et al.* (2011) and Horváth *et al.* (2012).

- 1) Collection of biological material (e.g. gametes, embryos and larvae): Vitiello *et al.* (2011) and Horváth *et al.* (2012) both used the striping method to obtain male gametes; they observe 60% and 63%, respectively, of sperm motility after activation for control.
- 2) Concentration of the biological material and addition of extender and cryoprotective agent: The extender solution and the cryoprotective agent are different in these studies: Vitiello *et al.* (2011) used seawater filtered with 15% ethylene glycol, while Horváth *et al.* (2012) used a Hank's balanced salt solution with 10% dimethyl sulfoxide.
- 3) Freezing: Freezing at: Vitiello *et al.* (2011) induced by a temperature drop of about -3°C per minute to a temperature down to -70°C and finally immersing the samples into liquid nitrogen. Horváth *et al.* (2012) froze in two steps: first vaporizing the samples in liquid nitrogen for three minutes and then immersing them in liquid nitrogen.
- 4) Thawing: In both studies, thawing was conducted in a water bath: at 55°C up to a temperature increase of 18°C of the packages (Vitiello *et al.* 2011), at 40°C for 13 seconds (Horváth *et al.* 2012);
- 5) Cryopreservation resulted in 50% motility (Vitiello *et al.* 2011) and 8% motility for (Horváth *et al.* 2012).

**Appendix S5** Summary of remote setting operations (1-12) for *O. edulis* according (and translated in English) to Guesdon *et al.* (1989), Carbonnier *et al.* (1990) and Coatanea *et al.* (1992).

- 1) Preparation of basins. Tanks must be clean and disinfected (e.g. chlorination). Paraffinization (liquefied wax) for a smooth rendering of the walls and bottom is recommended;
- 2) Installation of collectors: arrangement must allow a complete water circulation to avoid stagnation areas;
- 3) Water supply: after placing the collectors into the tanks, water at ambient temperatures and filtered to a minimum of 50 µm is added one day before receiving the larvae;
- 4) Larval transport: in the hatchery, larvae are concentrated on a moistened paper filter and then surrounded by a cotton cloth, placed in a plastic bag to avoid drying out and dispatched in isothermal packages equipped with ice packs (arrival temperature must not exceed 15°C);
- 5) Larvae quality control at reception: carried out under a binocular magnifier, larvae motility as well as the presence of the eyespot needs to be checked;

- 6) Choice of larval density and number of collectors per basin: a minimum density of 0.5 larvae ml<sup>-1</sup> is recommended but these choices are determined by the production objectives;
- 7) Larval immersion: Larvae must be acclimatized in a small volume of seawater with a slightly increasing temperature up to the temperature of the setting tanks. When larvae are diluted, a good but gentle vortex must be applied in order to dissociate the larvae that are clumping together;
- 8) Regulation of aeration in the basins: except for the settlement period when the bubbling is reduced to a minimum, the mixing must be sufficient enough for a good homogeneity of the water mass;
- 9) Water renewal: a water renewal of about 50% of the total tank volume per day is recommended;
- 10) Food supply: identical to any other culture of *O. edulis* larvae;
- 11) Larvae observation and harvesting: observation of the settlement rate by sampling and visual analysis, the harvest is generally carried out six to eight days after the larvae are immersed;
- 12) The transport of the young spat must be carried out in water or very quickly because it does not tolerate drying out.

## Appendix S6

### Glossary of some terms used in this review.

Terms	Definition
Oyster juveniles	Oyster spat larger than 2mm wide
Oyster seed	General term including all products resulting from reproduction, i.e. oyster larvae, oyster micro-spat, oyster spat, oyster juveniles.
Oyster spat	Settled larvae, also known as micro-spat (up to a size of ca. 2mm wide)



**Appendix II**          Supplementary Material of:

B. Colsoul, S. Pouvreau, C. Di Poi, S. Pouil, V. Merk, C. Peter, M. Boersma, B. Pogoda

**Addressing critical limitations of oyster (*Ostrea edulis*) restoration: Identification of nature-based substrates for hatchery production and recruitment in the field**

*Aquatic Conservation: Marine and Freshwater Ecosystems* 30: 2101-2115 (2020)

# HARZ-KALK

## Weißkalkhydrat WKH 2/4

### für Industrie und Umwelt



## Produkt-Datenblatt

### **Chemische Kenndaten:**

Ca(OH) <sub>2</sub>	%	93,5
CaO	%	72,5
MgO	%	0,6
SiO <sub>2</sub>	%	0,8
Fe <sub>2</sub> O <sub>3</sub>	%	0,3
Al <sub>2</sub> O <sub>3</sub>	%	0,4
SO <sub>3</sub>	%	0,1
CO <sub>2</sub>	%	1,3
Hydratwasser	%	22,7
Feuchte	%	1,0
Ca(OH) <sub>2</sub> wasserlöslich	%	92,5

### **Physikalische Kenndaten:**

Feinheit		
Rückstand 0,063 mm	%	0,7
Schüttgewicht	kg/l	0,4
Fließverhalten nach Imse		
D. 0,63 mm	%	30
Weißgehalt		
(Normfarbwert Z)	%	93
Raumbeständigkeit		
lineare Ausdehnung	%	0

### **Lieferwerk:**

Kalkwerk Schraplau (Werk 4)  
Bahnhofsstraße 1  
D-06279 Schraplau

Der Standort Kalkwerk Schraplau ist  
zertifiziert nach DIN EN ISO 14001.

### **Lieferform:**

Lose Ware, Bahn und Straße

Verpackt auf Europalette  
(25 kg-Säcke)

### **Qualitätsnachweis**

- Die genannten Werte stellen Durchschnittswerte entsprechend dem Stand unserer Kenntnisse dar. Die Produktkenndaten werden im Rahmen der FELS Qualitätssicherung überwacht und bei Änderungen aktualisiert.
- Das Qualitätsmanagementsystem der Fels-Werke GmbH, Geschäftsbereich FELS-Kalk ist zertifiziert nach DIN EN ISO 9001:2000-12 "Qualitätsmanagementsysteme - Anforderungen".
- Das Produkt ist fremdüberwacht nach DIN EN 459, Teil 1:2002-02 "Baukalk" und erfüllt die Anforderungen für Weißkalk EN 459-1 CL 90 - S.
- Das Produkt wird nach DIN EN 12518:2000-09 "Produkte zur Aufbereitung von Wasser für den menschlichen Gebrauch - Weißkalk" fremdüberwacht und erfüllt die Anforderungen an Klasse 1 nach Abschnitt 4.2 (Tab. 1 - Hauptbestandteile und Siebrückstände)  
Klasse 1 nach Abschnitt 4.3 (Tab. 2 - Verunreinigungen)  
Klasse 1 nach Abschnitt 4.4 (Tab. 3 - Wasserunlösliche Bestandteile)  
Typ A nach Abschnitt 4.5 (Tab. 4 - Toxische Substanzen)

### **Hinweis zum Umgang:**

Bitte Sicherheitsdatenblatt  
beachten

**FELS-Kalk**  
**Fels-Werke GmbH**  
Verkauf und Anwendungstechnik

Geheimrat-Ebert-Str. 12  
D-38640 Goslar  
Tel. (05321) 703 400/401  
Fax (05321) 703 424  
<http://www.fels.de>

Nr. 0094

**Figure S1** Technical data sheet of the composition of powdered hydrated lime from Fels-Werke GmbH used for the preparation of slaked lime (Ratio of 1 liter of seawater mixed with 1.2 liters of powder).

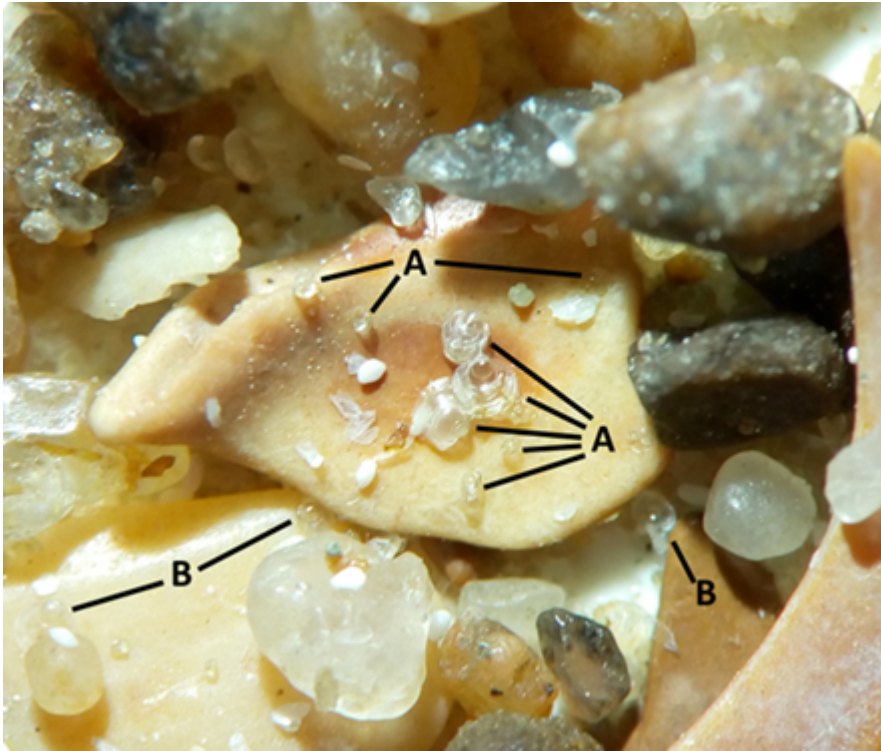

**Figure S2** Photograph of *Ostrea edulis* settled larvae on fine gravel sediment under a magnification of 8x. Larvae of *O. edulis* settled on a piece of shell are connected to points (A) by black lines; to points (B) are connected larvae settled on grains of sand or gravel.

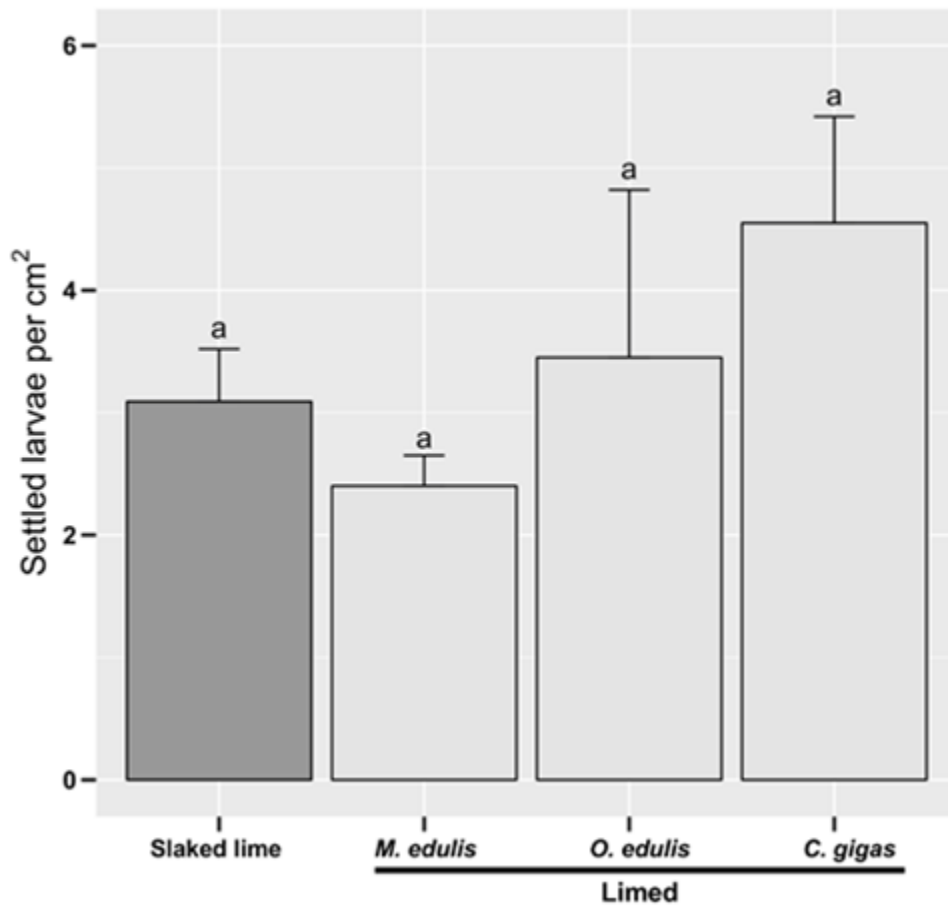

**Figure S3** Comparison of the settlement rate (orientations combined) of *Ostrea edulis* larvae between slaked lime (on tile) and marine bivalve shells coated with slaked lime in laboratory. Homogenous groups are marked with similar letters (ANOVA,  $F = 3.329$ ,  $p = 0.077$ ).



**Figure S4** Overview of the different substrates of a single replica in their experimental structures. Photographs (1-3) correspond to the experiment 1. Categories from left to right: the shells, the inorganics, and the sediments. Photograph (4) corresponds to the field experiment (all tested categories), and (5) corresponds to experiment 2 conducted on 3D reefs.



**Table S1** Composition of the clay raw materials from the company Korallenwelten®.

Component	Proportion (%)
SiO <sub>2</sub>	64.15
Al <sub>2</sub> O <sub>3</sub>	12.56
TiO <sub>2</sub>	1.15
Fe <sub>2</sub> O <sub>3</sub>	1.06
Na <sub>2</sub> O	0.13
K <sub>2</sub> O	1.55
CaO	11.36*
MgO	8.03*
SO <sub>3</sub>	-

The clay from a clay deposit in Westerwald (Hessen, Germany) is supplemented with magnesium oxide and calcium oxide.

**Table S2** Composition of the dolomite sand used for the 3D-ReefVival-Experimental-Reefs® printed by Boskalis Nederland BV.

Component	Proportion (%)
CaO	30.66
MgO	21.60
Fe <sub>2</sub> O <sub>3</sub>	0.02
Al <sub>2</sub> O <sub>3</sub>	0.02
SiO <sub>2</sub>	0.08
Loss 105-1100°C	47.35

**Table S3** List and distribution of the t substrates tested within the three experiments. Abbreviations: 1 = First laboratory experiment, 2 = Second laboratory experiment, 3 = Field experiment.

Substrate categories	Materials	Experiments		
		1	2	3
1) Shells	<i>Crassostrea gigas</i>	X		X
	<i>Mytilus edulis</i>	X		X
	<i>Ostrea edulis</i>	X		X
	<i>Pecten maximus</i>	X		
2) Inorganic	Baked clay	X		X
	Electro mineral accretion	X		
	Granite	X		
	Slaked lime	X		X
3) Sediments	Fine gravel	X		
	Coarse sand	X		
	Medium/Fine sand	X		
4) 3D structures	3D-ReefVival-Experimental-Reefs®		X	
5) Of plant origin	<i>Phyllostachys edulis</i>			X
	<i>Picea abies</i>			X
	<i>Juniperus communis</i>			X
6) Limed	Coated <i>C. gigas</i> shells			X
	Coated <i>M. edulis</i> shells			X
	Coated <i>O. edulis</i> shells			X
	Coated <i>P. edulis</i>			X
	Coated <i>P. abies</i>			X



## **Appendix III**

Full patent in German of:

B. Colsoul, B. Pogoda

**Land based method and apparatus for seeding a substrate with larvae of sessile aquatic animals [Landbasiertes Verfahren und Vorrichtung zum Besatz eines Trägerkörpers mit Larven von sessilen Wassertieren]**

Worldwide Patent WO2021115533A1 (2020)



(10) **DE 10 2019 134 230 B4** 2021.09.16

(12) **Patentschrift**

(21) Aktenzeichen: **10 2019 134 230.9**  
 (22) Anmeldetag: **13.12.2019**  
 (43) Offenlegungstag: **17.06.2021**  
 (45) Veröffentlichungstag  
 der Patenterteilung: **16.09.2021**

(51) Int Cl.: **A01K 61/54 (2017.01)**  
**A01K 61/00 (2017.01)**

Innerhalb von neun Monaten nach Veröffentlichung der Patenterteilung kann nach § 59 Patentgesetz gegen das Patent Einspruch erhoben werden. Der Einspruch ist schriftlich zu erklären und zu begründen. Innerhalb der Einspruchsfrist ist eine Einspruchsgebühr in Höhe von 200 Euro zu entrichten (§ 6 Patentkostengesetz in Verbindung mit der Anlage zu § 2 Abs. 1 Patentkostengesetz).

(73) Patentinhaber:  
**Alfred-Wegener-Institut, Helmholtz-Zentrum  
 für Polar- und Meeresforschung, 27570  
 Bremerhaven, DE**

(72) Erfinder:  
**Colsoul, Bérenger, Dr., 27570 Bremerhaven, DE;  
 Pogoda, Bernadette, Dr., 27570 Bremerhaven, DE**

<b>US</b>	<b>3 495 573</b>	<b>A</b>
<b>US</b>	<b>5 269 254</b>	<b>A</b>
<b>US</b>	<b>4 788 937</b>	<b>A</b>
<b>US</b>	<b>3 701 338</b>	<b>A</b>
<b>US</b>	<b>3 738 318</b>	<b>A</b>
<b>US</b>	<b>3 526 209</b>	<b>A</b>
<b>WO</b>	<b>2018/ 156 031</b>	<b>A1</b>

(56) Ermittelte Stand der Technik:

<b>US</b>	<b>9 144 228</b>	<b>B1</b>
<b>US</b>	<b>2011 / 0 250 017</b>	<b>A1</b>
<b>US</b>	<b>4 226 210</b>	<b>A</b>
<b>US</b>	<b>3 196 833</b>	<b>A</b>

**REEF DESIGN LAB: 3 D printed reefs. [2019].  
 5 S. URL: <https://www.reefdesignlab.com/3d-printed-reefs-1> [abgerufen am 03.12.2019]**

(54) Bezeichnung: **Landbasiertes Verfahren und Vorrichtung zum Besatz eines Trägerkörpers mit Larven von sessilen Wassertieren**

(57) Zusammenfassung: Bekannte Verfahren und Vorrichtungen arbeiten in einem Kreislaufsystem und umverpacken die besetzten Trägerkörper vor dem Ausbringen ins offene Wasser. Bei der Erfindung wird ein größerer Trägerkörper (03) in einen in der Größe entsprechend angepassten Behälter (02) eingebracht und mit Wasser (05), in dem sich vitale Larven (04) befinden, im Durchflusssystem umspült, wobei ein Sieb (27) das Ausspülen der Larven (04) verhindert. Während der Pediveligerphase werden so optimale Umgebungsbedingungen erreicht, die zu einem maximalen Besatz des Trägerkörpers (03) mit Larven (04) führen, wobei sich diese schon gut festgesetzt haben und nicht mehr so leicht durch natürliche Umwelteinflüsse abgespült werden können. Nach Beendigung der Pediveligerphase wird der Behälter (02) von seiner Versorgung abgekoppelt und mit einem Deckel (33) wasserdicht verschlossen. Der Trägerkörper (03) wird in dem ihn umgebenden Wasser (05) samt verbliebener freier Larven (04) an den Ort seiner Ausbringung transportiert. Dort wird er ins offene Meer abgesenkt und dient dann zur künstlichen Riffformung. Bei einem Besatz mit Austerlarven können so künstliche Austerbänke mit einer sehr hohen Austerndichte geschaffen werden.

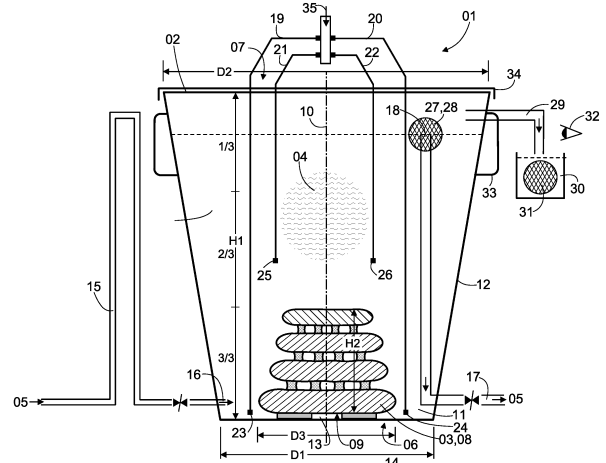

## Beschreibung

**[0001]** Die Erfindung bezieht sich auf ein landbasiertes Verfahren zum Besatz eines Trägerkörpers mit Larven von sessilen Wassertieren und auf eine landbasierte Vorrichtung zur Durchführung des Verfahrens, aufweisend einen Behälter, eine Befüllung des Behälters mit Wasser und freischwimmenden Larven, zumindest einen dreidimensionalen Trägerkörper als bevorzugtes Habitat für die Larven und eine temporäre Anordnung des Trägerkörpers im Behälter.

**[0002]** Als Schlüsselart mit besonderer ökologischer Funktion spielte die Europäische Auster eine wichtige Rolle im Ökosystem der Nordsee. Doch Wildbestände dieser heimischen Austernart *Ostrea edulis* sind inzwischen rar und die wenigen vorhandenen stark gefährdet. In der deutschen Nordsee - historisch hier weit verbreitet - gilt die Europäische Auster seit Mitte des 20. Jahrhunderts als ausgestorben, nur selten werden noch einzelne lebende Exemplare gefunden, und so steht sie auf der Roten Liste bedrohter Arten. Eine eigenständige Wiederansiedlung wird offenbar derzeit u. a. durch die intensive Bodenschleppnetz-fischerei verhindert. Die Europäische Auster wächst langsam und bildet spezifische, sehr artenreiche Lebensgemeinschaften mit vielen anderen wirbellosen Tieren und Fischen, in denen auch zahlreiche weitere Rote-Liste-Arten vorkommen. Der Lebensraum Austernbank bietet Nahrungs-, Schutz- und Rückzugsmöglichkeiten und dient vielen Fischarten als Kinderstube. Austernriffe sind Hotspots biologischer Vielfalt. Solch biogene, das heißt von Lebewesen aufgebaute Riffe sind in der Nordsee sehr selten geworden. Bis zu 240 Liter Meerwasser kann eine einzelne Auster pro Tag filtern. Sie ernährt sich dabei von Planktonorganismen im Wasser wie einzelligen Algen und organischen Schwebeteilchen. Durch ihre hohe Filtrationsleistung verbessern Austern zudem die Wasserqualität und können so lokal auch zu einer Verringerung toxischer Algenblüten beitragen. Auf Initiative des Bundesamtes für Naturschutz und des Alfred-Wegener Instituts, Helmholtz Zentrum für Polar- und Meeresforschung wurde Ende 2017 die Native Oyster Restoration Alliance (NORA) ins Leben gerufen. Dabei handelt es sich um ein europäisches Netzwerk zur Wiederansiedlung und Wiedereinbürgerung der inzwischen sehr seltenen und stark bedrohten heimischen Europäischen Auster. In dem Netzwerk gemeinsam vertreten sind Naturschutzbehörden, Wissenschaft, Naturschutzverbände wie auch Austern-Farmer. Langfristiges Ziel der Allianz: Die einheimische Europäische Auster soll als ehemalige Schlüsselart wieder in der Nordsee und angrenzenden europäischen Meeren etabliert und artenreiche Riffstrukturen möglichst umfangreich wiederhergestellt werden.

**[0003]** Für die Restaurierung werden die Larven bislang in situ auf Substraten gesammelt, was nur in Regionen mit ausreichender Larvenkonzentration möglich ist. Eine Translokation zwischen verschiedenen Regionen und Wasserkörpern ist aus Gründen der „biologischen Sicherheit“ zu vermeiden. Daher war nach anderen Lösungen zu suchen. In diesem Zusammenhang ist die vorliegende Erfindung entstanden, die auf der Erkenntnis beruht, dass künstliche Riffstrukturen, die bereits mit Austernlarven vorbesetzt sind, eine gute Ausgangslage für die Restaurierung bilden.

## Stand der Technik

**[0004]** Der der Erfindung nächstliegende Stand der Technik wird in der US 3 701 338 A offenbart. Beschrieben werden ein landbasiertes Verfahren und eine landbasierte Vorrichtung zum Vorbesatz von Muschelschalen mit Austernlarven. In einem bassinartigen Behälter mit einer Befüllung mit stehendem Wasser als künstlicher Wasserumgebung wird eine Vielzahl von freischwimmenden Larven der später im Erwachsenenstadium ortsfesten (sessilen) Austern gehalten. Oberhalb des Behälters befindet sich ein Vorratsbehälter für eine Vielzahl von dreidimensionalen Trägerkörpern in Form von aufgebrochenen Austernschalen. Im Behälter befindet sich ein schräg nach oben verlaufendes Förderband, das ungefähr bis zur Hälfte im Wasser verläuft und danach aus dem Wasser herausläuft. Im Verfahren werden im Anfangsbereich des Förderbands die Austernschalen aus dem Vorratsbehälter aufgestreut. Die Austernschalen werden dann vom Förderband im Wasser weitertransportiert und verbleiben dort temporär. Während dieses Zeitintervalls setzen sich die freischwimmenden Austernlarven an den Muschelschalen als bevorzugtem Habitat ab, wobei jedoch nicht sichergestellt ist, dass sich eine größtmögliche Anzahl von Larven in weitgehend homogener Verteilung auf der möglichst gesamten Muscheloberfläche absetzt. Schließlich werden die vorbesetzten Austernschalen aus dem Wasser heraustransportiert und vom Förderband in Netz-säcke eingeschüttet. Diese werden zunächst im Salzwasser in einem zweiten Behälter gelagert und später an die Orte für die Muschelzucht (Muschelbänke) verbracht. Dabei besteht aber die Gefahr, dass Larven wieder abfallen oder sogar absterben.

**[0005]** Die Bildung eines wasserbasierten Austernriffs mit Netzsäcken mit vorbesetzten Austernschalen ist beispielsweise aus der US 5 269 254 A bekannt. Aus der US 9 144 228 B1 ist es bekannt, Gerüste oder Ringe als Habitat für Muschellarven zunächst an einem natürlichen Ort im Wasser auszubringen, an dem ein hohes Vorkommen von freischwimmenden Larven besteht. Nach der Ansatzphase werden die vorbesetzten Trägerkörper dann an einen anderen Ort im Wasser verbracht, um dort zur Riffbildung beizutragen. Aus der WO 2018/156031 A1 sind ver-

tikale Röhren bekannt, die mit Larven vorbesetzte Trägerbänder aufweisen und anschließend in großen Formationen im Meer ausgebracht werden. Aus der US 3 738 318 A sind dreidimensionale Trägerkörper aus Beton bekannt, die der Anheftung und dem Aufwuchs von Austern dienen. Aus der US 4 788 937 A sind Trägerkörper für Austern aus einem Kunststoff bekannt. Aus der US 2011/0250017 A1 ist es bekannt, dreidimensionale Trägerkörper, die modular stapelbar sind, mit Kapseln mit vorgezogenem Seegrass zu besetzen, um daraus künstliche Riffe als Habitat für Wassertiere aufzubauen.

**[0006]** Aus der US 3 495 573 A ist es ein auf der Erkenntnis beruhendes Verfahren zur Selektion von Muschellarven bekannt, dass sich diese erst nach einem gewissen Zeitraum (12 bis 48 Stunden) so fest auf einem Substrat ansiedeln, dass ihre Entfernung Verletzungen hervorrufen würde. Deshalb werden die Muschellarven auf einem netzbespannten Gestell ausgesetzt und dann vor Ablauf des genannten Zeitraums (also vor Beginn der Ansiedlungsphase) physikalisch wieder entfernt. Dabei werden die Muschellarven, die noch keinen Kontakt mit dem Netz aufgenommen haben, zu einem späteren Zeitpunkt erneut auf das Netz gegeben. Die Muschellarven, die sich bereits in einer ersten Phase (vor der dauerhaften Festsetzung) angeheftet haben, werden mit einem harten Wasserstrahl oder einer Rakel entfernt und auf ein anderes Netz mit einer geringeren Maschengröße gegeben. Durch mehrmaliges Wiederholen dieses Vorgangs können die Muschellarven nach ihrer Größe sortiert und einzeln (ohne Substrat) abgegeben werden. Aus der US 3 196 833 A ist es für ein Verfahren zur Erzeugung von an Muschelschalen gebundenem Muschelspat in einem künstlichen Habitat bekannt, ein Maschensieb auf dem Boden eines wassergefüllten Behälters anzuordnen, sodass die von oben eingefüllten Larven bei ihrem Fall durch das Wasser abgebremst und nicht beim Auftreffen auf das Maschensieb beschädigt werden. Aus der US 3 526 209 A ist es für ein Verfahren und eine Anordnung zur Erzeugung von freiem Muschelspat bekannt, gebogene dünne Bleibleche mit einer glatten Oberfläche auf den Behälterboden zu stellen, die von den Muschellarven gerne zur Anheftung genutzt werden, wobei die Muschellarven, wenn sie die für eine Weitergabe geeignete Größe erreicht haben, einfach von den glatten Blechen abgestreift werden können. Schließlich ist aus der US 4 226 210 A eine Aquakultur zur Schneckenzucht (Abalone) bekannt, bei der sich die Schneckenlarven an Sieben anheften können, die in einem Gestell im Wasser vertikal aufgehängt sind, wobei dabei die herausnehmbaren Siebe im Wasser intensiv einer Lichteinstrahlung ausgesetzt werden.

**[0007]** Ausgehend von dem gattungsgemäßen landbasierten Verfahren und der Vorrichtung zum Besatz eines Trägerkörpers mit Larven von sessilen Wassertieren gemäß dem zuvor beschriebenen nächstliegenden Stand der Technik ist die Aufgabe für die vorliegende Erfindung darin zu sehen, das bekannte Verfahren und die daher bekannte Vorrichtung unter Beibehaltung der Landbasierung so weiterzubilden, dass ein optimaler Vorbesatz des Trägerkörpers mit Larven bester Vitalität und in hoher Besatzdichte erreicht werden kann. Desweiteren soll im Verfahren vorteilhaft sichergestellt werden, dass die mit Larven vorbesetzten Trägerkörper sicher an einen natürlichen Ort ihrer Ausbringung transportiert werden können. Die Lösung für diese Aufgabe ist dem Verfahrensanspruch und dem nebengeordneten Vorrichtungsanspruch zu entnehmen. Vorteilhafte Modifikationen der Erfindung werden in den jeweiligen Unteransprüchen aufgezeigt und im Folgenden zusammen mit der Erfindung näher beschrieben, wobei zunächst die beanspruchte Vorrichtung näher erläutert wird, da wesentliche konstruktive Elemente im beanspruchten Verfahren Anwendung finden können.

**[0008]** Da die beanspruchte Vorrichtung besonders vorteilhaft bei dem beanspruchten Verfahrens eingesetzt werden kann, soll zunächst näher auf die Ausgestaltung der mit der Erfindung beanspruchten Vorrichtung eingegangen werden. Bei der Erfindung werden Trägerkörper, die deutlich größer sind als eine Muschelschale, mit Larven im Behälter vorbesetzt. Das Volumen des Behälters ist erfindungsgemäß an das Volumen des Trägerkörpers angepasst, d.h., es wird ein entsprechend großer Behälter bereitgestellt, der den Trägerkörper bequem aufnehmen kann und eine gute Umspülung des Trägerkörpers mit larvenangereichertem Wasser gewährleistet. Dabei ist vorgesehen, dass der Behälter, in dem der Trägerkörper für den Besatz gelagert wird, eine Grundfläche mit einem Durchmesser aufweist, der in einem Bereich von einem Fünftel, also ungefähr 20%, größer ist als der Durchmesser der Grundfläche des eingestellten Trägerkörpers ist. Gleichzeitig ist die Höhe des Behälters in einem Bereich des Zweifachen größer als die Höhe des Trägerkörpers. Der Trägerkörper nimmt also im Behälter ungefähr nur ein Drittel der Behälterhöhe ein, wobei er im unteren Drittel des Behälters angeordnet ist. Weiterhin ist der Trägerkörper in der Mitte der Grundfläche des Behälters angeordnet. Schließlich ist auch noch ein Freiraum zwischen dem Trägerkörper und der Grundfläche des Behälters vorgesehen. Durch diese erfindungsgemäßen Dimensionierungen und konstruktiven Maßnahmen ist eine optimale Umspülung des Trägerkörpers von allen Seiten mit Wasser und damit mit freischwimmenden Larven sicher gewährleistet.

**[0009]** Um die Umspülung des Trägerkörpers mit Wasser, in der Regel Salzwasser, optimal umsetzen zu können, sind weiterhin bei der mit der Erfindung beanspruchten Vorrichtung ein Zulaufrohr mit einer Zulauföffnung, durch die im Betriebsmodus das Wasser in den Behälter strömt, und ein Ablaufrohr mit einer Ablauföffnung, durch die im Betriebsmodus das Wasser aus dem Behälter strömt, vorgesehen. Die Erfindung arbeitet somit als Durchflusssystem. Es wird eine möglichst naturnahe Strömung im Behälter erzeugt, stehendes Wasser wird vermieden. Desweiteren ist erfindungsgemäß vor der Ablauföffnung ein auswechselbares Sieb mit wählbarer, an die Größe der Larven angepasster Maschenweite, angeordnet. Hierdurch wird verhindert, dass die Larven mit dem strömenden Wasser aus dem Behälter herausgespült werden. Die Maschenweite ist in Abhängigkeit der Larvengröße und damit des Zeitfortschritts beim Besatz gewählt. Schließlich ist bei der Erfindung zumindest noch ein Luftzufuhrrohr mit einer Zuluftöffnung, durch die im Betriebsmodus Luft in das Wasser strömt, vorgesehen. Für ein optimales Verhalten der Larven während der Pediveligerphase (Anheftungsphase) ist eine ausreichende Sauerstoffversorgung von großer Bedeutung.

**[0010]** Die kontinuierliche Durchströmung des Behälters wird noch verbessert, wenn gemäß einer ersten Modifikation der Erfindung bevorzugt und vorteilhaft vorgesehen ist, dass die Zulauföffnung für das Wasser im Bereich der Grundfläche des Behälters die Ablauföffnung für das Wasser im Bereich des oberen Drittels des Behälters angeordnet ist. Die Ablauföffnung arbeitet dann wie ein Überlauf und begrenzt den Wasserspiegel im Behälter. Weiterhin wird die Belüftung des Wassers im Behälter noch verbessert, wenn gemäß einer nächsten Modifikation der Erfindung bevorzugt und vorteilhaft vorgesehen ist, dass vier Luftzufuhrrohre mit jeweils einer Zuluftöffnungen angeordnet sind, wobei zwei Zuluftöffnungen im Bereich der Grundfläche des Behälters und zwei Zuluftöffnungen im Bereich der Mitte des Behälters angeordnet sind. Somit wird frischer Sauerstoff sowohl im unteren Bereich des Trägerkörpers als auch oberhalb davon in das Wasser eingebracht. Die Larven zeigen dadurch eine besonders große Affinität zum Anheften an den Trägerkörper.

**[0011]** Um das Ausschwemmen der Larven über die Ablauföffnung zu vermeiden, ist ein Sieb vor der Öffnung angeordnet. Vorteilhaft und bevorzugt ist es dabei, wenn mehrere Siebe mit unterschiedlicher Maschenweite zum Auswechseln in der Vorrichtung vorgesehen sind, wobei zumindest ein erstes Sieb mit einer kleinsten Maschenweite im Bereich von 150 µm und ein zweites Sieb mit einer größten Maschenweite im Bereich von 300 µm vorgehalten werden können. Zu Beginn der Pediveligerphase haben die Larven alle eine bestimmte (kleine) Größe. Auf diese ist das Sieb abzustimmen. Im Verlauf der Phase wach-

sen die Larven, sodass auch die Maschenweite größer werden kann. Kleine Maschenweiten führen eher zum Verstopfen des Siebs. Deshalb ist es günstig, immer die größtmögliche Maschenweite einzusetzen: trotzdem muss das Sieb öfters gereinigt werden.

**[0012]** Auch bei einer regelmäßigen Reinigung des Siebs, vor allem aber bei einem unregelmäßigen oder unzureichenden Reinigen des Siebs kann ein Ansteigen des Wasserspiegels auftreten. Um zu verhindern, dass wertvolle Larven verloren gehen, ist es bevorzugt und vorteilhaft, wenn ein Notablauf oberhalb des Siebes oder ein elektronischer Wasserstandsalarm vorgesehen ist. Dann können schnell abhelende Maßnahmen ergriffen werden. Der Notablauf ist über dem Sieb und unterhalb der Oberseite des Behälters angeordnet und umfasst ein Ablaufrohr und einen (kleinen) Notbehälter. Dieser verfügt wiederum über ein abdeckendes Sieb, um die ggfs. ausgeschwemmten Larven selektieren und schnell in den Behälter rückführen zu können. Der Wasserstandsalarm (pear type) kann verwendet werden, um die Wasserversorgungspumpe abzuschalten.

**[0013]** Der Behälter soll stabil und gleichzeitig möglichst leicht sein, außerdem soll er aufgrund seiner Form gute hydrodynamische Bedingungen für die Larven während der Pediveligerphase gewährleisten. Dadurch wird eine hohe Homogenität bei der Larvenfixierung erreicht. Gemäß einer nächsten Erfindungsausgestaltung ist es daher bevorzugt und vorteilhaft, wenn der Behälter zylindrisch oder zylindronisch (hohlkegelstumpfförmig) ausgebildet ist und aus einem UVbeständigem Kunststoff, beispielsweise aus Polypropylen PP, besteht. Damit kann der Behälter nach der Pediveligerphase auch leicht zusammen mit dem vorbesetzten Trägerkörper an den Ort der geplanten Ausbringung und Riffbildung transportiert werden. Diese gute Handhabbarkeit wird noch unterstützt, wenn gemäß weiterer Modifikationen der Erfindung Tragegriffe am Behälter und /oder ein wasserdichter Deckel für den Behälter vorgesehen sind. Insbesondere der Deckel sorgt dafür, dass während des Transports kein Wasser aus dem Behälter schwappen kann. Der Behältergröße sind prinzipiell keine Grenzen gesetzt. Die Transportfähigkeit und die Größe der eingesetzten Trägerkörper sind hier die limitierenden Faktoren. In der Regel wird eine Größe im Bereich einer Wassertonne genutzt werden.

**[0014]** Es können bei der Erfindung alle Trägerkörper eingesetzt werden, die von den jeweilig eingesetzten Larven akzeptiert werden und sich zur dauerhaften Riffbildung eignen. Weiterhin müssen sie eine solche Größe aufweisen, dass sie sich zur eigenständigen Riffbildung, also ohne Anhäufung einer Vielzahl von Trägerkörpern, eignen. Bevorzugt können dreidimensionale Trägerkörper aus einem porösen Material und solche, die einer künstlichen Riffbildung im offenen Wasser dienen, eingesetzt wer-



den. Am Markt sind derartige Trägerkörper, die bevorzugt durch 3D-Druck (Additive Manufacturing) erzeugt werden können, kommerziell erhältlich. Größenabmessungen beispielsweise bis zu einem Kubikmeter Raum und darüber hinaus können eingesetzt werden. Insbesondere terrassenartige Trägerkörper mit mehreren Ebenen aus einem muschelkalkhaltigen Beton sind besonders für den Vorbesatz mit sessilen Larven geeignet. Auf einem derartigen Material siedeln sich besonders gerne Muscheln an, die im Erwachsenenstadium sessil (sesshaft) sind. Es ist deshalb vorteilhaft und bevorzugt, wenn bei einer weiteren Modifikation der mit der Erfindung beanspruchten Vorrichtung vorgesehen ist, dass der Behälter mit freischwimmenden Larven von Muscheln, bevorzugt von Austern, besonders bevorzugt von Europäischen Austern, befüllt ist.

**[0015]** Die zuvor beschriebene Vorrichtung kann besonders vorteilhaft in einem landbasierten Verfahren zum Besatz eines Trägerkörpers mit Larven von sessilen Wassertieren in einer künstlichen Wasserumgebung angewendet werden. Das landbasierte Verfahren umfasst dann erfindungsgemäß grundsätzlich zumindest folgende Verfahrensschritte:

- Bereitstellen eines Behälters und eines Trägerkörpers, wobei die Größe des Durchmessers der Grundfläche des Behälters in einem Bereich von einem Fünftel größer als der Durchmesser der Grundfläche des Trägerkörpers und die Höhe des Behälters in einem Bereich des Zweifachen größer als die Höhe des Trägerkörpers ist,
- Einhängen oder Aufständern des Trägerkörpers in den Behälter, wobei der Trägerkörper mittig bezogen auf die Grundfläche des Behälters und im unteren Drittel bezogen auf die Höhe des Behälters angeordnet wird und wobei zwischen der Grundfläche des Trägerkörpers und der Grundfläche des Behälters ein Freiraum belassen wird,
- Einströmen von Wasser durch eine Zulauföffnung eines Zulaufrohrs in den Behälter, wobei das Wasser durch eine Ablauföffnung eines Ablaufrohrs aus dem Behälter wieder ausströmen kann,
- Einbringen von freischwimmenden Larven in den Behälter,
- Belassen des Trägerkörpers im Behälter während einer Ansiedlungsphase, in der sich die Larven auf dem Trägerkörper ansiedeln können,
- Anordnen von Sieben mit unterschiedlicher Maschenweite vor der Ablauföffnung des Ablaufrohrs in aufeinanderfolgenden Zeitabschnitten während der Ansiedlungsphase, wobei Siebe mit zunehmender Maschenweite eingesetzt werden,

- mehrfaches Reinigen jedes Siebes innerhalb seines Einsatzes,
- Belüften des Wassers während der Ansiedlungsphase der Larven,
- Fütterung der Larven während der Ansiedlungsphase und
- Entnehmen des mit den Larven vorbesiedelten Trägerkörpers nach Beendigung der Ansiedlungsphase.

**[0016]** Das mit der Erfindung beanspruchte landbasierte Verfahren hat zum Ziel, ein dreidimensionales Substrat, den Trägerkörper, mit Larven außerhalb ihres natürlichen Lebensraums in einer künstlich geschaffenen Umgebung in optimaler Weise vorzubereiten. Dabei ist der landbasierte Vorbesatz, also der Vorbesatz auf dem Land, besonders vorteilhaft, weil er wesentlich unkomplizierter ist als ein Vorbesatz im offenen Wasser. Nach dem Vorbesatz werden die angehefteten Larven dann an natürlichen Orten im Wasser zur Wiederansiedlung zusammen mit dem Trägerkörper ausgesetzt. Die Vorteile eines solchen Vorbesatzes liegen in der genetischen Selektierbarkeit, dem Erhalt genetischer Artenvielfalt, der Verhinderung der Jagd auf juvenile Tiere sowie in der Kontrolle zu Samendichte, Krankheiten und Krankheits-erregern. Dazu kommt noch der kommerzielle Vorteil aufgrund der Landbasierung. Das Verfahren ermöglicht die Definition eines festen zeitlichen Startpunkts für die Besiedlung des Trägerkörpers, sodass zu diesem Zeitpunkt alle Individuen der Saat im gleichen Alter und damit ungefähr gleichgroß sind. Dadurch wird ein Monitoring erleichtert und ein erhöhtes Überleben der Jungtiere im späteren natürlichen Lebensraum im Wasser durch das vorherige Wachstum innerhalb einer kontrollierbaren Umgebung ermöglicht. Weitere Vorteile sind die Bestimmbarkeit des Zeitpunkts des Beginns der Larvenanheftung (Beginn der Pediveligerphase), der unabhängig von beispielsweise der Jahreszeit gewählt werden kann, die Bestimmbarkeit des Zeitpunkts des Aussetzens des mit den Larven vorbesiedelten Substrats in die natürliche Umgebung, die abhängig von beispielsweise der Jahreszeit erfolgen kann, und die Anwendbarkeit des Verfahrens auch in anderen Bereichen der Larvenansiedlung (mit entsprechenden Adaptionen).

**[0017]** Durch das Einhängen oder Aufständern des Trägerkörpers im Behälter ist gewährleistet, dass dieser vollständig vom Wasser im Behälter umspült wird und sich keine anoxischen Bereiche (Bereiche, an denen nicht ausreichend Sauerstoff vorhanden ist) bilden, sodass die Larven sich überall ansiedeln können (Pediveligerphase). Die Aufständernung kann beispielsweise mittels Keilen erfolgen, wobei der Trägerkörper im unteren Drittel des Behälters verbleibt. Durch die mittige Anordnung des Trägerkörpers über der Grundfläche des Behälters wird erreicht, dass um den Trägerkörper herum ein für die freischwimmen-

den Larven ausreichende Wassermenge vorhanden ist. Die Höhe des Trägerkörpers beträgt ungefähr ein Drittel der Höhe des Behälters. Der Durchmesser von dessen Grundfläche ist ungefähr ein Fünftel größer als der Durchmesser der Grundfläche des Trägerkörpers, vergleiche die Ausführungen zur Vorrichtung. Durch diese konstruktiven Maßnahmen wird bei der Erfindung zuverlässig erreicht, dass der gesamte Trägerkörper von Wasser mit freischwimmenden Larven umspült wird. Diese können sich somit homogen auf der gesamten Oberfläche des Trägerkörpers ansiedeln und dort verbleiben.

**[0018]** Um eine optimale Besiedlung des Trägerkörpers zu erhalten, ist es wichtig, gesunde und voll funktionsfähige Larven einzusetzen. Deshalb ist in einer nächsten Erfindungsausgestaltung bevorzugt und vorteilhaft vorgesehen, dass die Larven vor dem Einbringen in den Behälter bezüglich Mobilität, Mortalität, Deformation und Dichte (also Menge im Spat) überprüft werden. Damit die gesunden, eingesetzten Larven sich auch gut entwickeln, ist es weiterhin bevorzugt und vorteilhaft, wenn das Wasser, in der Regel künstliches, d.h. selbst zusammengestelltes Salzwasser, gefiltert, beispielsweise mittels eines Siebs mit 1 µm Maschenweite, und mit UV-Strahlung sterilisiert wird. Weiterhin ist es vorteilhaft, wenn das Wasser im Behälter ein- bis zweimal pro Stunde vollständig ausgetauscht wird. Dies erfolgt über die kontinuierliche Durchströmung des Behälters (Durchflusssystem). Mehr als zwei Austauschvorgänge pro Stunde sollten aber nicht durchgeführt werden, um eingebrachte Futterstoffe nicht zu schnell wieder zu entfernen. Der Bakteriengehalt des Wassers sollte regelmäßig kontrolliert werden. Er sollte idealerweise gleich oder kleiner 1000 Bakterien pro ml Wasser betragen. Die Belüftung der Vorrichtung über Belüftungsrohre muss konstant und gleichmäßig verteilt sein, um eine gute Versorgung des Wassers mit Sauerstoff und eine gute Durchmischung des Wassers zu erreichen. Diese Durchmischung optimiert die Verteilung des Futters, das regelmäßig zugeführt wird, und die Homogenität der Larvenfixierung.

**[0019]** Das mit der Erfindung beanspruchte landbasierte Verfahren ermöglicht aber nicht nur den optimalen Vorbesatz des eingesetzten Trägerkörpers, sondern vielmehr auch den geschützten Transport des vorbesetzten Trägerkörpers an den Ort seines Einsatzes. Dieser Transport erfolgt unter Belassen des Wassers im Behälter, sodass die angesiedelten Larven optimal versorgt werden und ggfs. abgefallene Larven sich erneut anheften können. Dazu ist es gemäß einer weiteren Erfindungsmodifikation bevorzugt und vorteilhaft, wenn der Behälter, der am Ende der Ansiedlungsphase den vorbesetzten Trägerkörper im Wasser enthält, von Zulaufrohr und Ablaufrohr abgekoppelt (wobei auch anderen Versorgungssysteme, die angeschlossen sind, beispielsweise für Sauerstoff und Futter abgekoppelt werden), und an-

schließend mit einem Deckel wasserdicht verschlossen wird. Der Behälter wird also aus dem Durchflusssystem genommen. Der Transport an einen Ort, in dessen Nähe mit dem besiedelten Trägerkörper ein künstliches Riff im offenen Wasser aufgebaut werden soll, kann dann problemlos erfolgen. Während des Transports kann das Wasser auch belüftet und gefiltert werden.

**[0020]** Eingangs wurde bereits darauf hingewiesen, dass insbesondere die heimischen Muscheln und mit ihnen deren Riffe vom Aussterben und vor Beschädigungen bedroht sind. Zunehmend wird deshalb versucht, durch künstliche Riffe hier Abhilfe zu schaffen. Insbesondere Muscheln, und hier vor allem Austern, sind übererntet und bedroht. Um hier die Bestände regenerieren zu können, ist es deshalb besonders bevorzugt und vorteilhaft, wenn bei dem mit der vorliegenden Erfindung beanspruchten Verfahren freischwimmende Larven von Muscheln (Klasse Bivalvia), bevorzugt von Austern (Ordnung Ostreida, Familie Austern), besonders bevorzugt von Europäischen Austern (Gattung *Ostrea edulis*), in den Behälter eingebracht werden. Aber auch alle anderen Wassertiere - neben den Manteltieren -, die dauerhaft sessil sind, beispielsweise Korallen, Schwämme, Moostierchen oder Armfüßer, eignen sich zum Einsatz bei dem beanspruchten Verfahren, um einen geeigneten Trägerkörper mit ihren Larven vorzubesetzen. Nähere Details hierzu und zu der oben beschriebenen Vorrichtung sind dem nachfolgenden Ausführungsbeispiel zu entnehmen.

#### Figurenliste

**[0021]** Die Vorrichtung zum Besatz eines Trägerkörpers mit Larven von sessilen Wassertieren und das damit verbundene Verfahren nach der Erfindung und ihre vorteilhaften Modifikationen werden anhand der schematischen, nicht maßstäblichen Figur zum besseren Verständnis nachfolgend noch weitergehend erläutert. Im Einzelnen zeigt die

Fig. eine schematische Querschnittsansicht durch eine erste Ausführungsform des Tauchfilters,

**[0022]** In der Fig. ist eine Vorrichtung **01** dargestellt mit einem Behälter **02** zum Besatz eines Trägerkörpers **03** mit Larven **04**, insbesondere Muschellarven. Durch den Behälter **02** strömt Wasser **05**. Der Behälter **02** zeigt im gewählten Ausführungsbeispiel eine zylindrokonusische Form, d.h. ein Durchmesser **D1** an seiner Grundfläche **06** ist kleiner als ein Durchmesser **D2** an seiner Oberseite **07**.

**[0023]** Im Behälter **02** ist temporär ein dreidimensionaler Trägerkörper **03** angeordnet. Im gezeigten Ausführungsbeispiel handelt es sich dabei um einen mehrstöckigen Turm **08** aus Scheiben und Streben. Derartige Trägerkörper **03** können durch 3D-Druck

hergestellt werden und sind kommerziell erhältlich, siehe beispielsweise „3D Printed Reefs“, Alex Goad, URL (abgerufen am 03.12.2019) <https://www.reefdesignlab.com/3d-printed-reefs-1>. Derartige Trägerkörper **03** bestehen aus Beton, Sandstein oder einem anderen geeigneten Material und können eine Höhe **H2** zwischen 0,50 m und 1,20 m aufweisen. Sie sind einfach über ein Seil im offenen Meerwasser aussetzbar.

**[0024]** Der Trägerkörper **03** weist an seiner Grundfläche **09** einen (gemittelten) Durchmesser **D3** auf. Dem gegenüber ist der Durchmesser **D1** der Grundfläche **06** des Behälters **02** ungefähr ein Fünftel, also ca. 20 %, größer. Aufgrund der mittigen (zentralen) Positionierung des Trägerkörpers **03** im Behälter **02** (mittig auf der Zentralachse **10** des Behälters **02**) ragt die Grundfläche **06** des Behälters umlaufend um ca. 10% ihres Durchmessers **D1** über die Grundfläche **09** des Trägerkörpers **03** hinaus. Dadurch ergibt sich ein für eine gute Umspülung ausreichender Spalt **11** zwischen der Behälterwandung **12** und dem Trägerkörper **03**. Weiterhin weist der Behälter **02** eine Höhe **H1**, der Trägerkörper **03** eine Höhe **H2** auf, wobei **H1** in einem Bereich des Zweifachen größer ist als **H2**. Der Behälter **02** ist damit ungefähr dreimal so hoch wie der Trägerkörper **03**. Schließlich befindet sich noch unterhalb des Trägerkörpers **03** ein Freiraum **13**, der so hoch bemessen ist, dass auch hier eine gute Durchspülung mit Wasser **05** erreichbar ist. Erzeugt wird der Freiraum **13** im gezeigten Ausführungsbeispiel durch mehrere Auflageböcke **14**, die auf der Grundfläche **06** des Behälters **02** angeordnet sind und auf denen der Trägerkörper **03** gelagert ist.

**[0025]** Die beanspruchte Vorrichtung **01** arbeitet als Durchflusssystem. Für das Einströmen des Wassers **05** ist ein Zulaufrohr **15** mit einer Zulauföffnung **16** vorgesehen. Vor dem Einströmen in den Behälter **02** wird das Wasser **05** gefiltert und mittels UV-Bestrahlung sterilisiert (in der Fig. nicht gezeigt). Aus dem Behälter **02** herausströmen kann das Wasser **05** über ein Ablaufrohr **17** mit einer Ablauföffnung **18**. Im gezeigten Ausführungsbeispiel ist die Zulauföffnung **16** im Bereich der Grundfläche **06** des Behälters **02** angeordnet. Die Ablauföffnung **18** ist hingegen im Bereich des oberen Drittels der Höhe **H1** des Behälters **02** angeordnet. Durch diese versetzte Anordnung wird eine gute Durchströmung des Behälters **02** mit Wasser **05** bzw. Durchmischung mit den Larven **04** erreicht. Durch den Durchflussbetrieb wird ein Teil des Wassers **05** ständig erneuert. Bevorzugt wird das gesamte Wasser **05** in Abhängigkeit vom nachgewiesenen Bakterienstatus ein- bis zweimal in der Stunde ausgetauscht. Eine höhere Austauschrate würde zur einer unnötigen Futterausspülung führen. Während der gesamten Pediveligerphase werden die Larven selbstverständlich regelmäßig gefüttert. Um auch eine gute Versorgung der Larven **04** mit Sauerstoff zu erreichen, sind im gezeigten Ausführungsbeispiel

vier Luftzufuhrrohre **19, 20, 21, 22** mit jeweils einer Zuluftöffnung **23, 24, 25, 26** vorgesehen, die in das Wasser **05** hineinreichen und Luft **35** zuführen. Eine gute Luftverteilung ergibt sich, wenn die beiden Zuluftöffnungen **23, 24** im Bereich der Grundfläche **06** des Behälters **02** und die beiden Zuluftöffnungen **25, 26** im Bereich der Mitte auf der Höhe **H1** des Behälters **02** angeordnet sind.

**[0026]** Um zu verhindern, dass die Larven **04** zusammen mit dem Wasser **05** aus der Ablauföffnung **18** herausgespült werden, ist vor der Ablauföffnung **18** ein Sieb **27** angeordnet. Dieses weist eine Maschenweite **28** auf, die an die aktuelle Größe der Larven **04** angepasst ist und diese im Behälter **02** zurückhält. Da die Larven **04** während der Pediveligerphase wachsen, werden mehrere Siebe **27** mit unterschiedlichen Maschenweiten **28** vorgehalten und entsprechend ausgetauscht. Beispielsweise können ein erstes Sieb **27** mit einer kleinsten Maschenweite im Bereich von 150 µm und ein zweites Sieb **27** mit einer größten Maschenweite im Bereich von 300 µm vorgehalten werden. Damit das Sieb **27** nicht verstopft, muss es regelmäßig von Ablagerungen befreit werden. Falls es doch einmal zu einer Verstopfung und damit zu einem Ansteigen des Wasserspiegels im Behälter **02** kommt, ist im gezeigten Ausführungsbeispiel ein Notablauf **29** vorgesehen, über den das überlaufende Wasser **05** ablaufen kann. Es wird dann in einem Auffangbehälter **30** aufgefangen. Auf diesem befindet sich ein weiteres Sieb **31**, von dem durchgelangte Larven **04** einfach abgesammelt und in den Behälter **02** rückgeführt werden können. Alternativ kann auch ein elektronischer Wasserstandsalarm **32** vorgesehen sein, der die aktuelle Wasserstandshöhe überwacht und bei Überschreiten eines Grenzwertes einen Alarm auslöst. Entsprechend kann dann das Sieb **27** gereinigt werden, sodass der Wasserspiegel wieder sinkt.

**[0027]** Der Behälter **02** weist im gezeigten Ausführungsbeispiel eine zylindrokonusische Form auf, die eine gute Durchströmung unterstützt. Der Behälter **02** ist stabil und trotzdem leicht. Er besteht beispielsweise aus einem UV-beständigen Kunststoff. Für einen einfachen Transport weist der Behälter **02** zwei seitliche Tragegriffe **33** auf. Damit beim Transport kein Wasser **05** aus dem Behälter **02** schwappt, kann dieser mit einem Deckel **34** wasserdicht verschlossen werden. Alle Versorgungsleitungen **15, 17, 19, 20, 21, 22** wurden natürlich zuvor entfernt. Vorhandene Ventile werden geschlossen.

**[0028]** Ein Transport des mit Larven **04** vorbesetzten Trägerkörpers **03** direkt im Behälter **02** ist besonders schonend für den Larvenbesatz. Der Trägerkörper **03** kann ohne Umbettung oder andere Umverpackung direkt an einen Ort im offenen Wasser gebracht werden. Dort wird er dann dem wassergefüllten Behälter **02** entnommen und direkt im Meerwasser versenkt,

wo er dann der künstlichen Riffbildung dient. Hierbei kann es sich insbesondere um ein Austernriff handeln, wenn Larven **04** von Austern eingesetzt werden. Dabei werden die ausgewählten Larven vor ihrem Einsatz auf Mobilität, Mortalität, Deformation und Dichte hin untersucht.

#### Bezugszeichenliste

<b>01</b>	Vorrichtung
<b>02</b>	Behälter
<b>03</b>	Trägerkörper
<b>04</b>	Larven
<b>05</b>	Wasser
<b>06</b>	Grundfläche 02
<b>07</b>	Oberseite 02
<b>08</b>	Turm als 03
<b>09</b>	Grundfläche 03
<b>10</b>	Zentralachse 02
<b>11</b>	Spalt zwischen 03 und 12
<b>12</b>	Behälterwandung
<b>13</b>	Freiraum zwischen 03 und 06
<b>14</b>	Auflagebock
<b>15</b>	Zulaufrohr
<b>16</b>	Zulauföffnung
<b>17</b>	Ablaufrohr
<b>18</b>	Ablauföffnung
<b>19</b>	erstes Luftzufuhrrohr
<b>20</b>	zweites Luftzufuhrrohr
<b>21</b>	drittes Luftzufuhrrohr
<b>22</b>	viertes Luftzufuhrrohr
<b>23</b>	erste Zuluftöffnung
<b>24</b>	zweite Zuluftöffnung
<b>25</b>	dritte Zuluftöffnung
<b>26</b>	vierte Zuluftöffnung
<b>27</b>	Sieb
<b>28</b>	Maschenweite
<b>29</b>	Notablauf
<b>30</b>	Auffangbehälter
<b>31</b>	weiteres Sieb
<b>32</b>	Wasserstandsalarm
<b>33</b>	Tragegriff
<b>34</b>	Deckel

<b>35</b>	Luft
<b>D1</b>	Durchmesser 06
<b>D2</b>	Durchmesser 07
<b>D3</b>	Durchmesser 03
<b>H1</b>	Höhe 02
<b>H2</b>	Höhe 03

#### Patentansprüche

1. Landbasiertes Verfahren zum Besatz eines Trägerkörpers (03) mit Larven (04) von sessilen Wassertieren in einer künstlichen Wasserumgebung mit zumindest den Verfahrensschritten:

- Bereitstellen eines Behälters (02) und eines Trägerkörpers (03), wobei der Durchmesser (D1) der Grundfläche (06) des Behälters (02) in einem Bereich von einem Fünftel größer als der Durchmesser (D2) der Grundfläche (09) des Trägerkörpers (03) und die Höhe (H1) des Behälters (02) in einem Bereich des Zweifachen größer als die Höhe (H2) des Trägerkörpers (03) ist,
- Einhängen oder Aufständern des Trägerkörpers (03) in den Behälter (02), wobei der Trägerkörper (03) mittig bezogen auf die Grundfläche (06) des Behälters (02) und im unteren Drittel bezogen auf die Höhe (H1) des Behälters (02) angeordnet wird und wobei zwischen der Grundfläche (09) des Trägerkörpers (03) und der Grundfläche (06) des Behälters (02) ein Freiraum (13) belassen wird,
- Einströmen von Wasser (05) durch eine Zulauföffnung (16) eines Zulaufrohrs (15) in den Behälter (02), wobei das Wasser (05) durch eine Ablauföffnung (18) eines Ablaufrohrs (17) aus dem Behälter (02) wieder ausströmen kann,
- Einbringen von freischwimmenden Larven (04) in den Behälter (02),
- Belassen des Trägerkörpers (03) im Behälter (02) während einer Ansiedlungsphase, in der sich die Larven (04) auf dem Trägerkörper (03) ansiedeln können,
- Anordnen von Sieben (27) mit unterschiedlicher Maschenweite (28) vor der Ablauföffnung (18) des Ablaufrohrs (17) in aufeinanderfolgenden Zeitabschnitten während der Ansiedlungsphase, wobei Siebe (27) mit zunehmender Maschenweite (28) eingesetzt werden,
- mehrfaches Reinigen jedes Siebes (27) innerhalb seines Einsatzes,
- Belüften des Wassers (05) während der Ansiedlungsphase der Larven (04),
- Fütterung der Larven (04) während der Ansiedlungsphase und
- Entnehmen des mit den Larven (04) vorbesiedelten Trägerkörpers (03) nach Beendigung der Ansiedlungsphase.

2. Landbasiertes Verfahren nach Anspruch 1, **gekennzeichnet durch**

- Überprüfen der Larven (4) vor dem Einbringen in den Behälter (02) bezüglich Mobilität, Mortalität, Deformation und Dichte.

3. Landbasiertes Verfahren nach Anspruch 1 oder 2, **gekennzeichnet durch**

- Filtern und UV-Sterilisieren des Wassers (05) vor dem Einströmen in den Behälter.

4. Landbasiertes Verfahren nach einem der Ansprüche 1 bis 3, **gekennzeichnet durch**

- Austauschen des Wassers (05) im Behälter ein- bis zweimal pro Stunde unter Berücksichtigung des Bakteriengehalts im Wasser (05).

5. Landbasiertes Verfahren nach einem der vorangehenden Ansprüche, **gekennzeichnet durch**

- Abkoppeln des Behälters (02) mit dem mit den Larven (04) besiedelten Trägerkörpers (03) nach Beendigung der Ansiedlungsphase zumindest von Zulufröhr (15) und Ablaufrohr (17),
- wasserdichtes Verschießen des Behälters (02) und
- Transport des verschlossenen Behälters (02) an einen Ort, in dessen Nähe mit dem besiedelten Trägerkörper (02) ein künstliches Riff im offenen Wasser aufgebaut werden soll.

6. Landbasiertes Verfahren nach einem der vorangehenden Ansprüche, **gekennzeichnet durch**

- Einbringen von freischwimmenden Larven (04) von Muscheln, bevorzugt von Austern, besonders bevorzugt von Europäischen Austern, in den Behälter (02).

7. Landbasierte Vorrichtung (01) zum Besatz eines Trägerkörpers (03) mit Larven (04) von sessilen Wassertieren, aufweisend

- einen Behälter (02),
- eine Befüllung des Behälters (02) mit Wasser (05) und freischwimmenden Larven (04),
- zumindest einen dreidimensionalen Trägerkörper (03) als bevorzugtes Habitat für die Larven und
- eine temporäre Anordnung des Trägerkörpers (03) im Behälter (02), **gekennzeichnet durch**
- eine Größe der Grundfläche (06) des Behälters (02), deren Durchmesser (D1) in einem Bereich von einem Fünftel größer als der Durchmesser (D2) der Grundfläche (09) des Trägerkörpers (03) ist,
- eine Höhe (H1) des Behälters (02), die in einem Bereich des Zweifachen größer als die Höhe (H2) des Trägerkörpers (03) ist,
- eine mittige Anordnung des Trägerkörpers (03) im Behälter (02),
- einen Freiraum (13) zwischen der Grundfläche (06) des Behälters (02) und dem Trägerkörper (03),
- ein Zulufröhr (15) mit einer Zulauföffnung (16), durch die im Betriebsmodus das Wasser (05) in den Behälter (02) strömt,
- ein Ablaufrohr (17) mit einer Ablauföffnung (18), durch die im Betriebsmodus das Wasser (05) aus dem Behälter (02) strömt,

- ein auswechselbares Sieb (27) mit wählbarer, an die Größe der Larven (04) angepasster Maschenweite (28),
- eine Anordnung des Siebes (27) vor der Ablauföffnung (18) und

- zumindest ein Luftzufuhrrohr (19, 20, 21, 22) mit einer Zuluftöffnung (23, 24, 25, 26), durch die im Betriebsmodus Luft in das Wasser (05) strömt.

8. Landbasierte Vorrichtung (01) nach Anspruch 7, **gekennzeichnet durch**

- eine Anordnung der zumindest einen Zulauföffnung (23, 24) im Bereich der Grundfläche (06) des Behälters (02) und
- eine Anordnung der zumindest einen Ablauföffnung (25, 26) im Bereich des oberen Drittels der Höhe (H1) des Behälters (02).

9. Landbasierte Vorrichtung (01) nach Anspruch 7 oder 8, **gekennzeichnet durch**

- vier Luftzufuhrrohre (19, 20, 21, 22) mit jeweils einer Zuluftöffnung (23, 24, 25, 26),
- eine Anordnung von zwei Zuluftöffnungen (23, 24) im Bereich der Grundfläche (06) des Behälters (02) und
- eine Anordnung von zwei Zuluftöffnungen (25, 26) im Bereich der Mitte der Höhe (H1) des Behälters (2).

10. Landbasierte Vorrichtung (01) nach einem der vorangehenden Ansprüche, **gekennzeichnet durch**

- mehrere Siebe (27) mit unterschiedlicher Maschenweite (28) zum Auswechseln in der Vorrichtung (01) und
- zumindest ein erstes Sieb (27) mit einer kleinsten Maschenweite im Bereich von 150 µm und ein zweites Sieb (27) mit einer größten Maschenweite im Bereich von 300 µm.

11. Landbasierte Vorrichtung (01) nach einem der vorangehenden Ansprüche, **gekennzeichnet durch**

- einen Notablauf (29) oberhalb des Siebes (27) oder einen elektronischen Wasserstandsalarm (32).

12. Landbasierte Vorrichtung (01) nach einem der vorangehenden Ansprüche, **gekennzeichnet durch**

- einen zylindrischen oder zylindrokonuschen Behälter (02) aus einem UVbeständigem Kunststoff.

13. Landbasierte Vorrichtung (01) nach einem der vorangehenden Ansprüche, **gekennzeichnet durch**

- Tragegriffe (33) am Behälter (02) und /oder
- einen wasserdichten Deckel (34) für den Behälter (02).

14. Landbasierte Vorrichtung (01) nach einem der vorangehenden Ansprüche, **gekennzeichnet durch**

- einen einzelnen dreidimensionalen Trägerkörper (03), der einer künstlichen Riffbildung im offenen Wasser dient.

15. Landbasierte Vorrichtung (01) nach einem der vorangehenden Ansprüche, **gekennzeichnet durch**

- eine Befüllung des Behälters (02) mit freischwimmenden Larven (04) von Muscheln, bevorzugt von Austern, besonders bevorzugt von Europäischen Austern.

Es folgt eine Seite Zeichnungen

Anhängende Zeichnungen

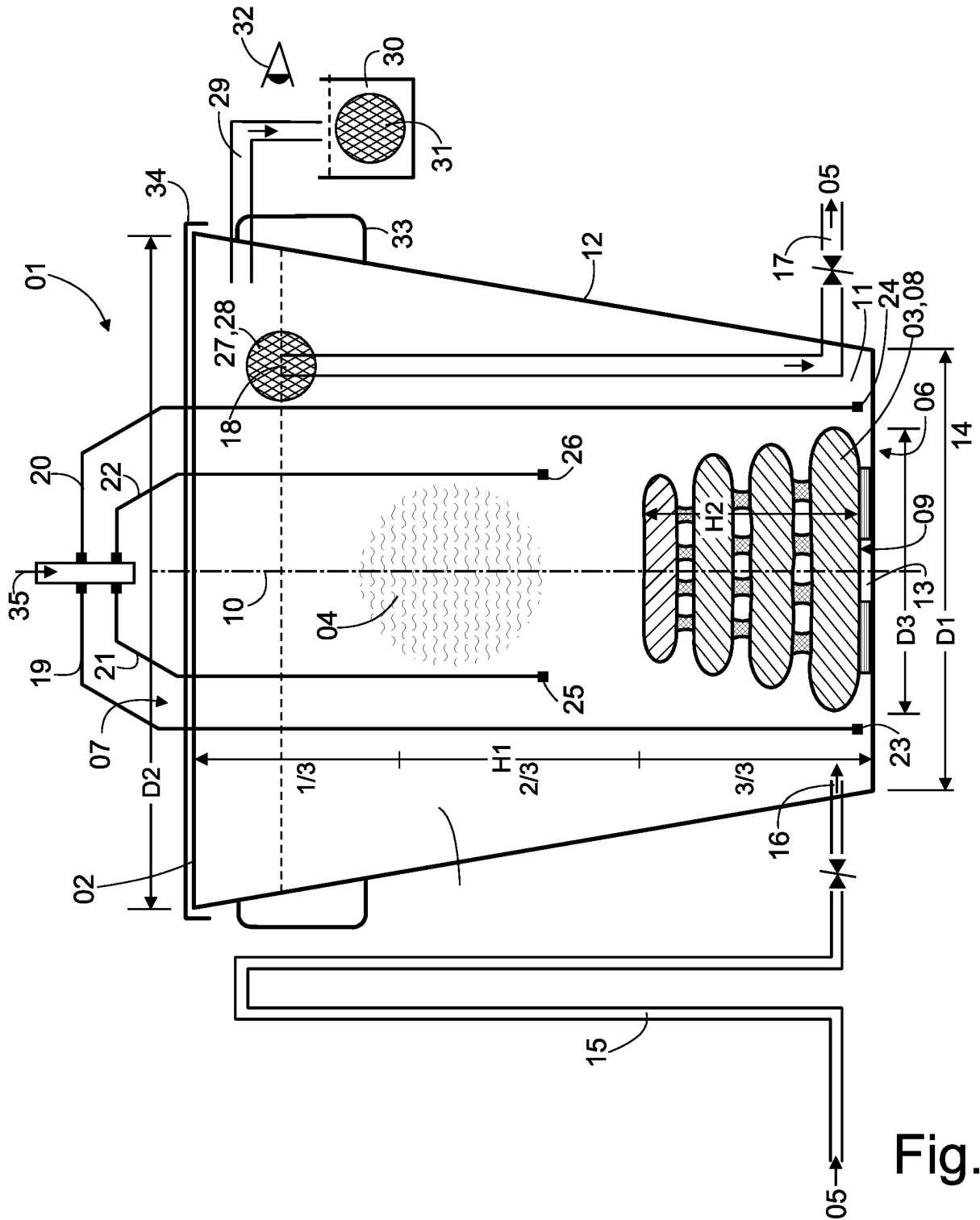

Fig.







# Acknowledgements

I would like to thank my supervisors, without whom this thesis would not have been possible:

Prof. Dr. Karen Wiltshire,

I would like to thank her in particular for the patience and freedom of action she gave me.

Prof. Dr. Maarten Boersma,

who always contributed with helpful discussions and scientific input to the topics and manuscripts within this thesis. In particular, I would like to thank him for introducing me to Biologische Anstalt Helgoland and his positive insistence on the completion of this thesis.

Dr. Bernadette Pogoda,

who from the beginning of this thesis never ceased to help me with scientific advice, introduced me to the world of restoration ecology, supported me in every phase of the thesis and especially in the difficult phases, supported me as much on the organisational and technical level as on the moral level. Bernadette, who gave my research and development ideas many chances and supported them.

Prof. Dr. Henning von Nordheim,

I would like to thank him for having introduced me to the world of marine conservation through numerous exchanges and meetings.

I would like to thank the following people in the same way:

All co-authors of the main three publications of this thesis: Prof. Dr. Luz Pérez-Parallé, Prof. Dr. Pierre Boudry, Dr. Ana Bratoš Cetinić, Dr. Carole Di Poi, Dr. Isabelle Arzul, Dr. Mathias Wegener, Dr. Simon Pouil, Dr. Stéphane Pouvreau, Corina Peter, Nicolas Mérou, Tristan Hugh-Jones, Verena Merk; All co-authors of the chapter and handbook on biosecurity: Prof. Dr. Chris Hauton, Prof. Dr. William Sanderson, Dr. Åsa Strand, Dr. Daniel Cowing, Dr. Joanne Preston, Dr. Philine zu Ermgassen, Alison Debney, Celine Gamble, Kelsey Thompson, Monica Fabra, Raimund Weber; All colleagues within the Alfred Wegener Institute: Prof. Dr. Bela Buck, Dr. Aldi Nel, Dr. Kristina Kunz, Dr. Laurie Hofman, Dr. Matthew Slater, Dr. Christian Bock, Christopher Gross, Clemens Kozian-Fleck, Gregor Jähne, Jörn Hafer, Kai Lorkowski, Lennard Klingforth, Martin Sackmann, Nicholas Mackay-Roberts, Nicolas Araujo Pineiro, Rajko Thiele, Sabine Strieben, Tanja Hausen, Ute Marx, the FS Heincke crew, the FS Uthörn crew, and the AWI Library personal; All non-AWI colleagues: Dr. Elodie Fleury, Dr. Roland Krone, Gaël Fleurent, Hélène Cochet, Hervé Leroy, Massoud Qayomi, Mathieu Hussenot, Thomas Rouault; All trainees and practical assistants (hiwis and azubis): Anna Klitsch, AnnKathrin Dischereit, Henrike Hohnholz, Kerstin von Twistern, Marie Koch; The funder organisation of the RESTORE and PROCEED projects, i.e. the German Federal Agency for Nature Conservation (BfN) – within this organisation, I would like to thank in particular Dr.

Katrin Prinz; and the Alfred Wegener Institute for the hosting of my research, as well as all the services offered: e.g. libraries, POLMAR and all stakeholders.

And last but not least: I would like to thank all the people who helped and supported me in all the activities, associated activities, on the side, and this throughout the doctoral period.



# Declaration

I, Bérenger Colsoul, hereby declare that the dissertation submitted, entitled “Ecological restoration of European flat oysters in the German Bight: seed production, substrate for larval settlement, and biosecurity in marine conservation” was written independently by me and only using the sources listed. The content and design of this thesis, apart from the supervisor’s guidance, is my own work. The thesis has not been submitted either partially or wholly as a part of a doctoral degree to another examining body and is my first and only doctoral procedure. This work has been prepared respecting the Rules of Good Scientific Practice of the German Research Foundation. I have not been deprived of an academic degree.

Bremerhaven, 14.07.2022

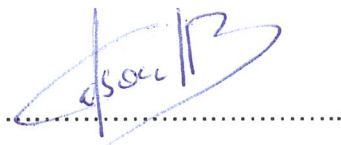

Bérenger Colsoul

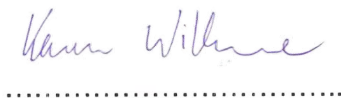

Prof. Dr. Karen Wiltshire