

Acidification of forest soil in Russia: From 1893 to present

A. G. Lapenis,¹ G. B. Lawrence,² A. A. Andreev,³ A. A. Bobrov,⁴ M. S. Torn,⁵
and J. W. Harden⁶

Received 3 June 2003; revised 14 December 2003; accepted 23 January 2004; published 10 March 2004.

[1] It is commonly believed that fine-textured soils developed on carbonate parent material are well buffered from possible acidification. There are no data, however, that document resistance of such soils to acidic deposition exposure on a timescale longer than 30–40 years. In this paper, we report on directly testing the long-term buffering capacity of nineteenth century forest soils developed on calcareous silt loam. In a chemical analysis comparing archived soils with modern soils collected from the same locations ~100 years later, we found varying degrees of forest-soil acidification in the taiga and forest steppe regions. Land-use history, increases in precipitation, and acidic deposition were contributing factors in acidification. The acidification of forest soil was documented through decreases in soil pH and changes in concentrations of exchangeable calcium and aluminum, which corresponded with changes in communities of soil microfauna. Although acidification was found at all three analyzed locations, the trends in soil chemistry were most pronounced where the highest loading of acidic deposition had taken place.

INDEX TERMS: 4805 Oceanography: Biological and Chemical: Biogeochemical cycles (1615); 1615 Global Change: Biogeochemical processes (4805); 0315 Atmospheric Composition and Structure: Biosphere/atmosphere interactions; 4215 Oceanography: General: Climate and interannual variability (3309); *KEYWORDS:* acidic deposition, biogeochemical cycles, soil

Citation: Lapenis, A. G., G. B. Lawrence, A. A. Andreev, A. A. Bobrov, M. S. Torn, and J. W. Harden (2004), Acidification of forest soil in Russia: From 1893 to present, *Global Biogeochem. Cycles*, 18, GB1037, doi:10.1029/2003GB002107.

1. Introduction

[2] Research during the past 20 years has identified acidic deposition as a causal factor in the decreased availability of base cations (particularly Ca and Mg) in forest soils of the United States and Europe [Wesselink *et al.*, 1995; Markewitz *et al.*, 1998]. Insufficient Ca and Mg availability in soils has been linked to reduced stress tolerance in red spruce [Shortle *et al.*, 1997] and sugar maple [Horsley *et al.*, 1999], and a lack of response in surface water chemistry to decreasing acidic deposition levels [Likens *et al.*, 1996; Lawrence *et al.*, 1999]. Despite progress in understanding the effects of acidic deposition on soil base cation availability, large uncertainties remain with respect to the magnitude and rate of change. Without this information, projections of ecosystem recovery from further reductions in acidic deposition also remain uncertain. Perhaps the most limiting factor in

assessing soil changes has been a lack of knowledge about soil conditions before the onset of acidic deposition. Current efforts to predict the outcome of emission-reduction scenarios rely on modeling of soil processes that cannot be verified with long-term data.

[3] Two studies have used direct remeasurement to evaluate changes over more than a few decades. Tamm and Hallbacken [1986] identified a decrease in pH of 0.3 to 0.65 units between 1927 and 1984 in Swedish soils, and Johnson *et al.* [1994] identified statistically significant decreases in pH and acid extractable Ca concentrations from 1930 to 1932 to 1984 in forest soils of the Adirondack Mountains of New York. In both studies, changes were attributed to a combination of acidic deposition and net forest growth.

[4] An opportunity recently became available to evaluate changes in soil chemistry over the twentieth century through the use of the Historic Russian Soil Collection (HRSC), which has been preserved at the St. Petersburg Academy of Forestry in St. Petersburg, Russia. Soil monoliths (complete, intact soil profiles) collected between 1893 and 1895 by Rafail Vasil'evich Rizpolozhensky have been kept in horizontal, dust-proof wooden boxes that have not been treated with resins or adhesives. The sampling approach for collecting intact profiles was developed by Rizpolozhensky and continues to be used in Russia today. Detailed records of original site locations, conditions at the time of sampling, and methods used to prepare HRSC monoliths have also been preserved by the Academy of Forestry [Lapenis *et al.*,

¹Department of Geography and Planning, Department of Earth and Atmospheric Sciences, State University of New York at Albany, Albany, New York, USA.

²U.S. Geological Survey, Troy, New York, USA.

³Alfred Wegener Institute for Polar and Marine Research, Potsdam, Germany.

⁴Department of Geography, Moscow State University, Moscow, Russia.

⁵Lawrence Berkeley National Laboratory, Berkeley, California, USA.

⁶U.S. Geological Survey, Menlo Park, California, USA.

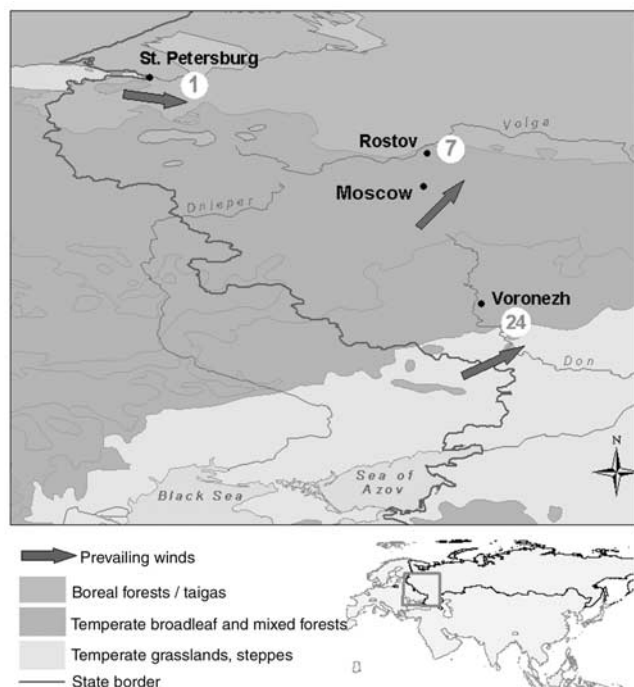

Figure 1. Locations of three Historic Russian Soil Collection (HRSC) sites and direction of prevailing winds according to *Shahgedanova* [2003]. See color version of this figure at back of this issue.

2000; *Lapenis*, 2002]. Records of land use and climate since the sampling are also available for these sites.

[5] The objective of this study was to utilize the HRSC to evaluate changes in soil acidity and base cations in soils of three sites in western Russia that have been exposed to different levels of acidic deposition. During the past few decades these sites received levels of acidic deposition that ranged from 20 to 80 kg $\text{SO}_4^{2-} \text{ha}^{-1} \text{yr}^{-1}$. Changes in land use, climate, and soil carbon content were also considered as possible factors influencing base cations and soil acidity. By resampling sites first sampled by Rizpolozhensky, soils that predate or nearly predate acidic deposition were directly compared to current soils using modern analytical methods. Pollen spectra and testate amoeba species composition (identified by their siliceous shells, which are preserved in the soil) from the forest floor of archived and modern soils were also examined to aid in the assessment of possible changes in climate and land-use effects. An analysis of the species composition of the testate amoeba community was included, because species occurrence reflects specific environmental conditions within the soil.

2. Methods

[6] For this study, three sites, originally sampled in 1893 (labeled 1, 7, and 24; Figure 1), were chosen for resampling. Soils at these sites all developed from fine-textured calcareous materials deposited over limestone bedrock, a reflection of the quaternary geology typical for much of central and western Russia [*Myasoedov et al.*, 1969; *Pantuykhin*,

1973]. These sites differ significantly from each other, however, with respect to historic acidic deposition rates, climate, and forest history during the twentieth century. The sites are therefore useful for evaluating the effects of natural and anthropogenic acidification processes on soils generally considered to be well buffered. The sites were located with an accuracy of ± 100 m using detailed descriptions of the original sampling sites, comparison of modern maps (1986, 1991) with local maps from that era (1883, 1913), and local landmarks that existed when Rizpolozhensky worked. Sites 1 and 7 were resampled in July 1997, and Site 24 was resampled in August 1998.

2.1. Atmospheric Deposition Measurements

[7] Measurements of atmospheric deposition of SO_4^{2-} were available within 200 km of each of the three study sites [*Roskomgidromet*, 2000]. Data from this source were verified with data from 1990 to 1992 presented by *Crane and Gallasso* [1999]. Collections were made with a funnel placed in an open area away from trees and were emptied at least weekly. The annual deposition was calculated from monthly mean concentrations of SO_4^{2-} and monthly precipitation. The decline in deposition in the late 1980s through the early 1990s reflects a sharp decline in industrial production, caused by the breakup of the former USSR (Figure 2). The increase in SO_4^{2-} deposition for 1995 to 2000 reflects the rebuilding economy. Data for Moscow and Voronezh were available only for 8 years in the interval from 1976 to 1999. In St. Petersburg, measurements of sulfate depositions were available for 1913, 1956, 1971–1995, 1997, and 1999.

2.2. Site 1, East of St. Petersburg

[8] Site 1, located in the taiga, had a mean annual temperature of 5.4°C, and a mean annual precipitation in the early twentieth century of 67 cm yr^{-1} [*Groisman*, 1991]. During the last century, annual precipitation at this site has increased 6 to 7 cm or 10% to 12%, while the mean annual

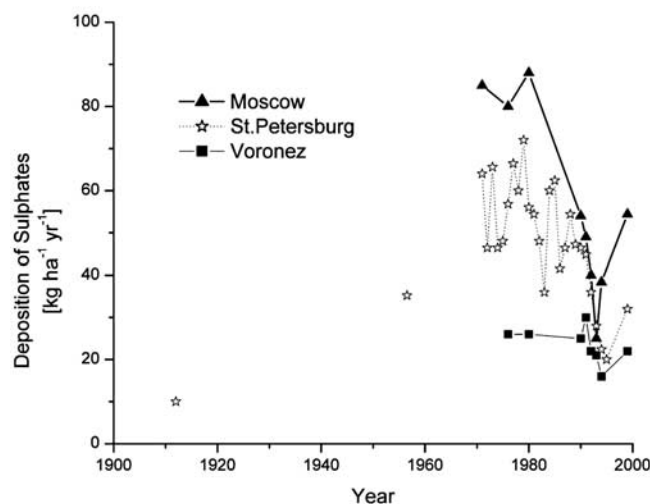

Figure 2. Annual bulk deposition of sulfate in St. Petersburg, Moscow, and Voronezh.

Table 1. Pollen Spectra of Forest Floor, and Peat Bog Deposits^a

Pollen Types	Site 1	Site 1	Site 7	Site 7
	(Soil) 1893	(Soil) 1998	(Soil) 1893	(Soil) 1998
<i>Pinus sylvestris</i>	27.3	11.6	47.6	13.8
<i>Picea abies</i>	14.6	16.9	1.6	6.4
<i>Betula sect. Alba</i>	4.5	21.4	28.6	46.5
<i>Alnus glutinosa</i>	0.0	1.3	0.0	0.3
<i>Alnus incana</i>	1.1	21.0	2.9	0.0
<i>Alnus sp</i>	0.4	0.3	0.0	0.6
<i>Corylus avelana</i>	1.3	0.6	1.6	3.1
<i>Quercus robur</i>	0.4	0.0	0.0	0.0
<i>Tilia cordata</i>	0.4	0.0	0.0	0.3
<i>Salix</i>	0.4	0.0	0.3	0.3
<i>Lonicera</i>	0.4	0.0	0.0	0.0
<i>Rosaceae</i>	0.2	0.6	0.0	0.0
<i>Artemisia</i>	0.4	0.0	0.3	0.9
<i>Poaceae</i>	6.5	4.5	0.3	10.1
<i>Cerealea</i>	5.0	0.0	0.0	8.6
<i>Asteraceae</i>	1.3	0.3	0.0	0.3
<i>Chenopodiaceae</i>	1.3	0.0	0.0	0.3
<i>Ranunculaceae</i>	2.8	1.0	0.3	0.9
<i>Cyperaceae</i>	4.8	0.3	0.0	1.2
<i>Polygonaceae</i>	0.4	0.0	0.0	1.2
<i>Apiaceae</i>	0.6	1.0	0.0	0.0
<i>Caryophyllaceae</i>	0.2	0.3	0.0	0.0
<i>Cichoriaceae</i>	6.5	0.0	0.0	0.0
<i>Centaurea cyanus</i>	0.2	0.0	0.0	0.0
<i>Ericales</i>	0.0	2.2	0.0	0.0
<i>Chimaphila umbellata</i>	0.0	0.0	16.5	0.0
Indetermined herb pollen	0.4	1.3	0.0	2.8
<i>Sphagnum</i>	0.6	2.2	0.0	0.3
<i>Polypodiaceae</i>	14.8	12.6	0.0	0.6
<i>Bryales</i>	1.1	0.0	0.0	0.6
<i>Equisetum</i>	0.2	0.3	0.0	0.9
<i>Pteridium</i>	0.4	0.0	0.0	0.0
<i>Lycopodium sp.</i>	0.0	0.3	0.0	0.0
<i>L. clavatum</i>	0.6	0.0	0.0	0.0
<i>L. annotinum</i>	0.4	0.0	0.0	0.0
<i>Encalypta</i>	0.4	0.0	0.0	0.0
Trees & shrubs pollen sum	50.8	73.1	82.6	71.3
Herbs pollen sum	30.6	11.5	17.4	26.3
Spores pollen sum	18.6	15.4	0.0	2.4
Pollen and spores sum (total count)	100 (466)	100 (312)	100 (315)	100 (327)

^aCounts of pollens in modern forest floor are given for central pit.

temperature has increased about 1°C [Groisman, 1991]. The Cambic Podzols (FAO classification system) of Site 1 developed from ancient Ladoga Lake bottom deposits (silt loam) accumulated during the last glaciation over Silurian limestone [Pantjukhin, 1973]. The modern shore of Ladoga Lake is located about 30 km north of this site, which lies in an area of flat, low-lying topography. Profile descriptions of both modern and historic samplings record an A horizon of approximately 10 cm that grades into a well-defined E horizon (8 cm in the historic profile, 13 cm in the modern profile). The texture of the profile ranges from loam to clay loam.

[9] The historic sample was collected in a small meadow used for harvesting hay, located between the road (that remained unaltered at the time of resampling) and a forest of spruce and pine (Table 1). The entire region was forested prior to Russian settlement in the early 1700s [Cvetkov, 1957], but the date at which the site was cleared is unknown. Within about 20 years after the first sampling, this area became part of the Myslinski State Farm, which

allowed the forest to regrow without management other than sporadic selective logging up to the present. Overstory vegetation at the time of the modern sampling was comprised of European white birch (*Betula alba*), spruce (*Picea abies*), Scotch pine (*Pinus sylvestris*), alder (*Alnus sp.*), and willow (*Larix sp.*). Tree cores of spruce within 300 m of the pit indicated ages of 47 to 96 years.

[10] Bulk deposition measured approximately 10 km west of the St. Petersburg city line (120 km west of the site) indicated that SO_4^{2-} deposition in the 1970s exceeded 60 kg $\text{SO}_4^{2-} \text{ha}^{-1} \text{yr}^{-1}$ (Figure 2) [Roskomgidromet, 2000]. Deposition rates declined to a minimum of 20 kg $\text{SO}_4^{2-} \text{ha}^{-1} \text{yr}^{-1}$ in 1995, then gradually increased up to 1999. Earlier deposition measurements indicate inputs of 36 kg $\text{SO}_4^{2-} \text{ha}^{-1} \text{yr}^{-1}$ in 1956, and 10 kg $\text{SO}_4^{2-} \text{ha}^{-1} \text{yr}^{-1}$ in 1913 [Chertov, 1990].

2.3. Site 7, North of Moscow

[11] Site 7, located in the mixed forest vegetation zone, has a mean annual temperature (last 30 years) of 4.8°C and a mean annual precipitation of 64 cm yr^{-1} . As at Site 1, precipitation at Site 7 has increased 6 cm over the last 100 years, and mean annual temperature has increased about 1°C [Groisman, 1991; Groisman et al., 1991].

[12] Cambic podzols (FAO classification) at this site developed from loess deposits and till from both the last glaciation and the Dneiper (Russian analog of Penultimate) glaciation (80,000–100,000 B.P.). Surficial material is underlain by limestone, as well as layers of Devonian lake and river deposits [Sergeev, 1984]. The site lies in an upland position in an area of rolling topography. Profile descriptions of both modern and historic samplings indicate an A horizon of approximately 12 cm that grades into a well-defined E horizon (8 cm in the historic profile, 15 cm in the modern profile). At the time of Rizpolozhensky's sampling, the site was a mature forest of primarily Scotch pine. The site remained forested throughout the twentieth century, but was routinely thinned and selectively cut. Increased agricultural activities in the area and some cattle grazing within the forest resulted in the forest being cleared for pastures to within 1 km of the site. Predominant vegetation at the time of the modern sampling was European birch (*Betula alba*), Scotch pine (*Pinus sylvestris*), and Norway Spruce (*Picea abies*). Tree cores of Scotch pine within 100 m of the pit indicate tree ages of 61 to 84 years.

[13] In 1976, bulk deposition approximately 20 km west of the Moscow city line (200 km south of the site) exceeded 80 kg $\text{SO}_4^{2-} \text{ha}^{-1} \text{yr}^{-1}$, but declined to 25 kg $\text{SO}_4^{2-} \text{ha}^{-1} \text{yr}^{-1}$ in 1995 (Figure 2). Deposition then increased to 60 kg $\text{SO}_4^{2-} \text{ha}^{-1} \text{yr}^{-1}$ in 1999. Site 7 receives additional deposition from the industrial city of Rostov, located approximately 50 km north of the site.

2.4. Site 24, Southeast of Voronezh

[14] Site 24, located in the forest steppe vegetation zone, has a modern mean annual temperature of 9.4°C and mean annual precipitation of 54 cm yr^{-1} . During the last hundred years, mean annual precipitation at this site has increased about 10 cm and mean annual temperature increased about 1.5°C [Ivanov, 1991; Groisman, 1991].

[15] Soils classified as Greyzems (FAO) developed from yellow loess deposited over till from the Dnieper glaciation, underlain by dolomitic bedrock [Myasoedov *et al.*, 1969]. This region lies south of the terminal moraine of the last glaciation [Sergeev, 1984].

[16] The A horizon in the historic sampling was up to 25 cm thick, whereas the thickness of this horizon in the modern sampling was up to 12 cm thick. In both samplings, the soils exhibited an AE horizon of about 5 cm that graded into an AB horizon. This site is located in Quadrant 32 of Shipov's Forest, which has been managed for oak production since the early 1700s, to supply lumber for the Black Sea fleet [Uspensky, 1997]. As a result, stand composition has not significantly changed over this period. The site was last clear-cut in 1880 and has only been thinned since [Myasoedov *et al.*, 1969].

[17] According to periodic observations (at least one per decade), documented in publications by the Shipov's Forest Experimental Station, the predominant tree species, white oak (*Quercus alba*), has not changed since the last historic sampling. Small numbers of ash, maple, and European linden are also found in the forest [Myasoedov *et al.*, 1969]. Bulk deposition of SO_4^{2-} at Voronezh (100 km northwest of Site 24) remained below $30 \text{ SO}_4^{2-} \text{ ha}^{-1} \text{ yr}^{-1}$ in a record that extended back to 1975.

2.5. Soil Sampling and Analysis

[18] At the three sites, a "central" pit was established at the most probable location of the earlier sampling. An additional three to four pits were also dug in a 100-m radius around the main pit to quantify the spatial variability of soil properties in the immediate vicinity [Torn *et al.*, 2002]. In each pit, soil samples were collected from pit faces at 2- to 10-cm intervals from the Oe horizon to the top of the C horizon. Horizontal cores (5 cm diameter) were also collected from the face of the central pit at depth intervals of 10 cm, with bulk density determined from the core samples after drying at 100°C . Archived soils were sampled by removing a 5-cm-wide channel of soil from the full length of the monolith, leaving another 15 cm of monolith width for future studies. Modern soils were air dried for storage, with moisture content determined after drying at 100°C . Historic and modern soils were passed through a 2-mm sieve before chemical analysis. Unfortunately, archives do not have any information on bulk density of soil at the time of sampling. Therefore in our analysis we made an assumption that archived soil had the same bulk density as modern soil, which we sampled for bulk density.

[19] All soil samples were analyzed for soil pH (H_2O and 0.1 N KCl extraction), exchangeable acidity (exchangeable Al; quantification limit $0.04 \text{ cmol}_c \text{ kg}^{-1}$, and exchangeable H; quantification limit $0.02 \text{ cmol}_c \text{ kg}^{-1}$, following 1N KCl extraction by the method of Thomas [1982]), exchangeable base cations (unbuffered 1N NH_4Cl ; quantification limit $0.02 \text{ cmol}_c \text{ kg}^{-1}$ [Blume *et al.*, 1990]), total C (C-H-N analyzer), and total sulfur (LECO total S analyzer [David *et al.*, 1989]). Cation exchange capacity (CEC) was calculated as the sum of exchangeable cations. Archived and modern soil samples were subjected to analysis at the same facilities: exchangeable bases and exchangeable acidity at the U.S.

Geological Survey, Troy, New York, total carbon and pH at the State University of New York at Albany, and total sulfur at the University of Illinois.

2.6. Pollen and Amoebae Analysis

[20] The archived and modern samples of Oe soil horizons from Site 1 and 7 were analyzed for preserved pollens to provide information on land use and plant community structure that was independent of historical records. The land use history and trends in vegetation at Site 24 were well documented in publications by Shipov's Forest Experimental Station [Myasoedov *et al.*, 1969]. Therefore in this work we did not analyze pollen spectra and testate amoebae counts from this particular site. As is shown later, Site 24 can be characterized by stable over time composition of major plant species and absence of any significant disturbances since the end of the nineteenth century. This comparison represents, to our knowledge, the first attempt to use archived samples of forest floor for pollen analysis. Pollens were prepared using the following modifications of standard techniques [Faegri *et al.*, 1989]. Samples were treated multiple times with boiling HF, up to 3 hours each, punctuated by rinses with warm, concentrated HCl; 3 min of acetolysis; and fine-sieving with an 8- μm nitex screen [Cwynar *et al.*, 1979]. In each sample, 300–500 pollen grains were counted at 400x magnification, and a tally of spores was also kept.

[21] At Sites 1 and 7, samples of the forest floor were also analyzed for communities of Testate amoebae (*Rizopoda*), a microscopic (1–400 micrometer in size) unicellular organism that is typically abundant in wet soils and aquatic habitats. These animals produce proteinaceous, agglutinate, siliceous, or calcareous shells that are well preserved in fossil situations such as Holocene lake and peat deposits and can be used for identification of the paleoenvironment [Tolonen, 1986]. For example, data on changes in Testate amoeba communities were successfully used to reconstruct such parameters of the ancient lake environment as temperature and water acidity [Tolonen, 1986]. In this work we found that shells of many *Rizopoda* species were also well preserved in both the archived and modern soil samples. Because *Rizopoda* are known to be sensitive to the amount and chemistry of the water in which they live, analysis of species composition was done to determine if changes in their community had occurred in these soils over the 100-year period. As for the pollen analysis, this is the first analysis of testate amoeba communities conducted on archived soil samples.

3. Results

3.1. Site 1

[22] Historical records and pollen analysis both indicate that some time during the first part of the twentieth century, a mature forest developed from grassland at Site 1. The pollen spectrum of the modern Oe horizon at Site 1 contained mostly arboreal pollen (86%) that reflected the dominance of *Betula*, *Alnus*, *Picea abies*, and *Pinus sylvestris* in the modern forest, whereas the historic sample was only 51% arboreal pollen (Table 1). The shift in pollen abundance from Scotch pine to birch suggests selective logging for this preferred tree species in the forest of this area.

[23] The amoebae community in the historic sample from Site 1 was represented at low densities (approximately 2575 cells per 1 g of dry soil) by only 13 species that are typically found in shallow, oligotrophic forest floors with low availability of organic soil carbon. Among testate amoebae included in the community was *Trigonopyxis arcuata*, a species typically found in relatively dry forest floors of coniferous forests [Tolonen, 1986; Bobrov et al., 1995]. In the Oe horizon of the modern sample at Site 1 the total number of species is approximately 3 times greater, and the density is more than 4 times greater (Table 2). This increase in density was mostly due to species generally associated with moist soils with high organic soil carbon content such as *Trinema complantum*, *T. lineare*, *Euglypha laevis*, and *Tracheleuglypha acolla*, [Bonnet and Thomas, 1960; Laminger, 1978]. The density of the dry forest species, *Phryganella acropodia*, was much lower in the modern sample from Site 1 than in the historic sample. Other species found in modern samples at Site 1 that favor moist soils are *Arcella catinus*, *A. arenaria* var. *compressa*, *Centropyxis elongata*, and *Nebela lageniformis* [Chardez, 1965]. The acidophilic species, *Nebela lageniformis* [Chardez, 1965], were found in the modern sample but not in the historic sample.

[24] Water and salt-extractable pH was lower in the modern samples than in the historic sample, from approximately 5 cm below the surface to approximately 25 cm below the surface (A and AE horizons). Below 25 cm, pH was similar, although the salt-extractable value was somewhat lower in the modern sample. Higher concentrations of exchangeable Ca were measured in the modern samples from 5 cm below the surface to approximately 60 cm below the surface, and exchangeable Al was also higher in the modern sample from approximately 10 cm below the surface to 35 cm below the surface (Figure 3). The only exchangeable base cation for which concentrations were lower in the modern sample was Na^+ , if averaged over the entire profile. Higher values of cation exchange capacity (CEC) were measured in the modern samples from approximately 5 cm from the surface to 60 cm from the surface (Figure 5). When exchangeable carbonates [Ca + Mg] were expressed as a percentage of CEC, values in the historic and modern samples were similar, with the exception of the 50 to 60 cm depth, at which modern samples had the higher values (Figure 6). Concentrations of total sulfur were higher in the modern samples than in the historic sample from 5 to 20 cm below the surface (Figure 7), and total organic carbon concentrations were also higher in the modern samples from 5 to 40 cm below the surface (Figure 8).

3.2. Site 7

[25] Historical records and pollen analysis indicate that land-use changes at Site 7 were likely restricted to selective logging and some cattle grazing of the under story. The evergreen herb, pipsissewa (*Chimaphila*), was common in the historic pollen record, but absent in the modern pollen record. Overall, Scotch pine, spruce, and birch, as described by Rizpolozhensky at the time of the historic sampling, dominated the pollen spectrum of modern samples from Site 7. As was found at Site 1,

there was a shift in the predominant tree species from *Pinus sylvestris* in the historic samples to *Betula* in the modern samples, which suggests preferential logging for Scotch pine (Table 1).

[26] The historic sample of forest floor at Site 7 contained 25 shelled amoebae species that included the moisture preferring species *Centropyxis orbicularis*, and *Centropyxis aerophila* var. *sphagnicola* (Table 2). Although *Centropyxis aerophila* var. *sphagnicola* is acidophilic, *Centropyxis plagiostoma* is typically found in carbonate soils with a pH only slightly below 7 [Bobrov, 1995]. The modern sample at Site 7 contained a similar density and number of species, but the acidiphilic species, *Diffugiella oviformis* f. *fusca*, and *C. plagiostoma* [Bobrov et al., 1999; Bonnet and Thomas, 1960] were more abundant in the modern sample than in the historic sample. There was also a greater abundance of species that prefer moist soils (*Cyclopyxis puteus*, *Arcella arenaria* v. *compressa* and *Assulina minuta* c.f.) in the modern samples than in the historic samples [Bobrov et al., 1999; Decloritre, 1981].

[27] Site 7 exhibited higher values for water and salt-extractable pH in the historic sample than in the modern sample, throughout the sampled profile (Figure 3). Exchangeable Ca concentrations were considerably lower in the A, AE, and E horizons of modern samples, but similar in the two samples in the B and BC horizons (Figure 4a). Exchangeable Al concentrations were less in the modern samples in the E horizon, but were generally similar above and below this horizon (Figure 4b). All concentrations of both acidic and basic cations were less in the modern samples than in the historic samples, when averaged over the entire profile. In contrast to Site 1, CEC was lower in the modern sample in the top 45 cm of the profile (Figure 5). Percent saturation of carbonates was also lower in the modern sample in parts of the A, AE and E horizon (Figure 6). Concentrations of total S were somewhat higher in the modern sample throughout the profile (Figure 7), whereas total organic carbon was somewhat less in the modern sample throughout the profile (Figure 8).

3.3. Site 24

[28] Water-extractable pH was similar in historic and modern samples in the top 40 cm of the profile, but was somewhat lower in the historic sample than in the modern sample from 40 to 65 cm (Figure 3). However, salt-extractable pH was lower in the modern samples throughout most of the profile (Figure 3). There was little difference between historic and modern concentrations of exchangeable Ca in the Oi, A, and upper AE horizons, but modern concentrations were considerably less than historic concentrations in the AB horizon (Figure 4a). Exchangeable Al concentrations in the modern samples were below detection in most of the A and AE horizons. Measurable concentrations were observed in the historic sample for these horizons, although values were an order of magnitude less than those of Sites 1 and 7 (Figure 4b). Differences in cation concentrations for the overall profile between historic and modern samples were minimal, with the exception of K, for which concentrations were less in the modern sample. Both CEC and exchangeable carbonates showed little difference

Table 2. Testate Amoebae Species in Soil and Peat Bog Deposits^a

Species	Site 1 (Soil) 1893	Site 1 (Soil) 1998	Site 7 (Soil) 1893	Site 7 (Soil) 1998
<i>Arcella arenaria</i>	0.0	0.2	0.0	0.5
<i>A. bathystoma</i>	0.0	0.0	0.0	0.0
<i>A. catinus</i>	0.0	0.2	0.0	0.0
<i>A. gibbosa</i>	0.0	0.0	0.0	0.0
<i>A. megastoma</i>	0.0	0.0	0.0	0.0
<i>A. vilgaris</i>	0.0	0.0	0.0	0.0
<i>Centropyxis aerophila</i>	0.0	1.7	4.6	0.9
<i>C. aerophila</i> var. <i>sphagnicola</i>	0.0	0.0	0.9	6.3
<i>C. aculeate</i>	0.0	0.0	0.0	0.0
<i>C. aculeate</i> v. <i>grandis</i>	0.0	0.0	0.0	0.0
<i>C. aculeate</i> v. <i>oblonga</i> f. <i>minor</i>	0.0	0.0	0.0	0.0
<i>C. aerophila</i>	0.0	0.0	0.0	0.0
<i>C. capucina</i>	0.0	0.0	0.9	0.0
<i>C. cassis</i>	0.0	0.0	0.0	0.0
<i>C. constricta</i>	0.0	0.0	0.0	0.0
<i>C. discoides</i>	0.0	0.0	0.0	0.0
<i>C. ecornis</i>	0.0	0.0	0.0	0.0
<i>C. ecornis</i> v. <i>minuta</i>	0.0	0.0	0.0	0.0
<i>C. elongata</i>	0.0	3.3	1.8	0.5
<i>C. orbicularis</i>	0.0	0.0	5.5	0.3
<i>C. plagiostoma</i>	0.0	1.7	0.9	1.4
<i>C. plagiostoma</i> var. <i>terricola</i>	0.0	0.0	0.0	0.0
<i>C. sylvatica</i> (Deflandre)	6.1	5.1	10.1	29.4
<i>C. sylvatica</i> var. <i>minor</i>	0.0	5.5	1.8	17.9
<i>C. kahli</i>	4.5	2.3	1.8	0.9
<i>C. kahli</i> var. <i>cyclostoma</i>	0.0	0.2	0.0	0.0
<i>C. puteus</i>	0.0	0.0	0.0	0.5
<i>Cyclopyxis kalhi</i>	0.0	0.0	0.0	0.0
<i>Diffugia acutissima</i>	0.0	0.0	0.0	0.0
<i>D. corona</i>	0.0	0.0	0.0	0.0
<i>D. cratera</i>	0.0	0.0	0.0	0.0
<i>D. globulosa</i>	0.0	0.0	0.0	0.0
<i>D. globules</i>	0.0	0.0	0.0	0.0
<i>D. mammilaris</i>	0.0	0.0	0.0	0.0
<i>D. lacustris</i>	0.0	0.0	0.0	0.0
<i>D. litophila</i>	0.0	0.0	0.0	0.0
<i>D. oblonga</i>	0.0	0.0	0.0	0.0
<i>D. oblonga</i> c.f.	0.0	0.0	0.0	0.0
<i>D. penardi</i>	0.0	0.2	0.0	0.0
<i>D. pyriformis</i>	0.0	0.0	0.0	0.0
<i>D. tricornis</i> c.f.	0.0	0.0	0.0	0.0
<i>D. venusta</i>	0.0	0.0	0.0	0.0
<i>Euglypha ciliata</i>	0.0	0.2	0.0	0.0
<i>E. ciliata</i> f. <i>glabra</i>	1.5	1.4	1.8	0.0
<i>E. compressa</i>	0.0	0.4	0.0	0.0
<i>E. compressa</i> f. <i>glabra</i>	0.0	0.4	0.9	0.0
<i>E. cuspidata</i>	0.0	0.5	0.0	0.0
<i>E. laevis</i>	4.5	10.6	6.4	3.2
<i>E. laevis</i> var. <i>lanceolata</i>	0.0	0.3	0.0	0.0
<i>E. strigosa</i>	0.0	0.3	0.9	0.0
<i>E. strigosa</i> f. <i>glabra</i>	0.0	0.0	0.9	0.0
<i>E. sp.</i>	0.0	0.3	1.8	0.0
<i>Euglyphella elegans</i>	0.0	0.2	0.0	0.9
<i>Heleopera penardi</i>	0.0	0.0	0.0	0.5
<i>H. petricola</i>	0.0	0.6	0.0	0.0
<i>H. petricola</i> var. <i>amethystea</i>	0.0	0.2	0.0	0.0
<i>H. sylvatica</i>	0.0	0.2	0.0	0.0
<i>Hyaloshemia papilio</i>	0.0	0.0	0.9	0.0
<i>Hyalosphenia elegans</i>	0.0	0.0	0.0	0.0
<i>Lagenodiffugia vas</i>	0.0	0.0	0.0	0.0
<i>Nebela collaris</i>	0.0	1.3	0.0	0.0
<i>N. lageniformis</i>	0.0	1.9	0.0	0.0
<i>N. parvula</i> Cash	1.5	0.9	0.0	0.0
<i>N. penardiana</i>	0.0	0.0	0.0	0.0
<i>Plagiopyxis bathystoma</i>	1.5	1.6	0.0	0.5
<i>P. callida</i>	0.0	2.1	0.9	0.5
<i>P. declivis</i>	7.6	3.0	15.6	17.6
<i>P. minuta</i>	0.0	0.4	0.0	0.0
<i>P. oblonga</i>	25.8	1.4	15.6	0.3
<i>P. penardi</i>	0.0	1.4	0.0	0.0

Table 2. (continued)

Species	Site 1 (Soil) 1893	Site 1 (Soil) 1998	Site 7 (Soil) 1893	Site 7 (Soil) 1998
<i>Pontigulasia compressa</i>	0.0	0.0	0.0	0.0
<i>P. elisa</i>	0.0	0.0	0.0	0.0
<i>P. spectabilis</i> c.f.	0.0	0.0	0.0	0.0
<i>Schoenbornia humicola</i>	9.1	1.5	0.0	0.5
<i>Sch. viscicula</i>	0.0	0.0	0.0	0.5
<i>Trigonopyxis arcula</i>	4.5	0.0	0.0	0.0
<i>Phryganella acropodia</i>	31.8	1.8	9.2	3.2
<i>Assulina muscorum</i>	0.0	0.0	1.8	0.0
<i>Valkanovia delicatula</i>	0.0	0.7	0.0	0.5
<i>Tracheleuglypha acolla</i>	1.5	10.8	0.0	7.7
<i>Corythion dubium</i>	0.0	0.2	0.9	0.0
<i>Trinema complanatum</i>	0.0	5.8	2.8	0.3
<i>T. complanatum</i> var. <i>globulosa</i>	0.0	0.2	0.0	0.0
<i>T. enchelys</i>	0.0	2.0	6.4	0.0
<i>T. lineare</i>	0.0	27.0	4.6	4.6
<i>T. penardi</i>	0.0	0.4	0.0	0.0
<i>Diffugiella</i> var. <i>fusca</i>	0.0	0.0	0.0	0.9
Total sum	100.0	100.0	100.0	100.0
Number of grams in sample	7725	1650	3587	4360

^aCounts of testate amoebae (as percent of total) in modern soil represent average of three samples.

between the historic and modern samples, with the exception of somewhat lower carbonate saturation in the lower AB horizon of the modern samples than the historic sample (Figure 5). In the A horizon, total S was higher in the modern sample than in the historic sample, but was similar in the rest of the profile. Total organic C was somewhat higher in the historic sample than in the modern sample in the top 5 cm of the profile, but showed little difference between these samples in the rest of the profile (Figure 8).

4. Discussion

[29] Although soils at the three sites all developed from similar, Ca-rich parent material, the differences in soil chemistry between the historic and modern samples varied considerably among the sites as a result of differences in the effects of vegetation history, climate change, and acidic deposition levels.

4.1. Site 1: Forest Regrowth in a Century of Changing Climate and Elevated Acidic Deposition

[30] At the time of the historic sampling, the upper 20 cm of the profile at Site 1 had undergone acidification to a considerable degree. Relative to the values for the historic samples from Sites 7 and 24, salt-extractable pH and exchangeable Ca concentrations were considerably less. The organic carbon content in the upper profile of the historic sample was also less than in the historic samples from the forested sites. Many decades (possibly more than a century) of hay removal were likely to have been a major factor in the chemistry measured in the historic sample of Site 1. Uptake of base cations by grasses generated acidity that could not be neutralized by subsequent decomposition of the plant material because it was taken off site. Continuous removal of biomass also hindered the accumulation of organic matter, which resulted in the low CEC of this site relative to the similarly textured soils of the forested sites. Below about 30 cm, pH and exchangeable Al concentra-

tions suggested less acidification in the lower profile than the upper profile of the historic sample. Exchangeable Ca concentrations showed little variation to a depth of 60 cm, however, well below the presumed depth of influence by grass roots. Depletion of Ca in the lower profile of the historic sample could possibly reflect the influence of an extended period of forestation that predated the use of the site for hay production, but historic information to verify this interpretation is not available.

[31] Approximately 90 years of forest growth resulted in a number of changes in soil chemistry. With biomass removal limited to selected cutting of trees, organic matter had the opportunity to accumulate in the soil to a depth of 40 cm. Increased soil moisture from the increasing trend of precipitation may also have contributed to the accumulation of organic matter. Wetter soils, richer in organic matter in the modern sampling than in the historic sampling, are indicated by the large increase in numbers of testate amoeba taxa that favor moist, organic soil. Increased organic matter content resulted in increased CEC and an increase in concentrations of all exchangeable cations measured, with the exception of Na. This response is particularly interesting because increases in exchangeable Al concentrations are generally expected to be accompanied by decreases in exchangeable Ca concentrations [Reuss *et al.*, 1990]. In the upper profile of Site 1, however, exchangeable Ca concentrations increased despite further acidification of the soil.

[32] Increased concentrations of exchangeable Ca cannot be explained by organic matter accumulation below 40 cm, where concentrations were the same in the historic and modern samples. Increases in exchangeable Ca concentrations in the lower profile may be related to the increase in precipitation that occurred over the century. The annual mean position of the water table at this low-lying site was recently estimated to be 2 m below the surface, 0.5 m closer to the surface than 40 years earlier [Georgievskii *et al.*, 1996]. Higher, more frequent, water table rises could provide high concentrations of dissolved Ca from deeper

substratum, where Ca weathering fluxes exceed those of the lower soil profile.

[33] Concentrations of exchangeable Ca were higher in the modern sample than in the historic sample throughout the soil profile at this site, despite acidic deposition. The effects of increased CEC and water table level may have overcompensated for the effects of increased leaching from

acidic deposition. Under low levels of acidic deposition, increases in exchangeable Ca might have been higher than what we measured, but the relative magnitude of these processes is uncertain. Increased acidity in the upper soil profile can be attributed to net uptake by vegetation, as live biomass increased at the site, and also to acidic deposition. As in the case of Ca concentrations, the relative effects of these processes on soil acidity are uncertain. Higher concentrations of total sulfur in the upper profile of the modern sample than in the historic sample also could be related to acidic deposition, although this difference was also likely to be related to increased concentrations of organic matter.

4.2. Site 7: Acidification of Calcareous Soil by High Levels of Acidic Deposition

[34] At the time of the historic sampling the soil at Site 7 was acidic, although to a lesser extent than soil at Site 1. The mature forest that was present at the time of the historic sampling suggests that acidification of this well-buffered calcareous soil was the result of podzolization, caused by forest growth processes. Naturally derived organic acidity, generated from net uptake of base cations by roots and incomplete decomposition of litter, was the most likely cause of low pH. Lower concentrations of exchangeable Ca and higher concentrations of exchangeable Al in the upper profile than in the lower profile are a typical characteristic of podzolic soils [Buol et al., 1980]. Low concentrations in the AE (and possibly E) horizon relative to the A and EB horizons for organic carbon, exchangeable Ca, and exchangeable Al also reflect podzolization processes.

[35] Although the site remained forested between samplings, it was not free from disturbance during this period. The shift from Scotch pine to birch, and the disappearance of *Chimaphila*, coincided with the transition period when private land was converted to large collective farms following the 1917 revolution. It is likely that logging intensity increased to support the development of the collective farms, which would increase the abundance of birch whose regeneration is favored by disturbance. Cattle raising in the area would be likely to impact the abundance of *Chimaphila*, a preferred food of cattle, because Russian farmers typically allow cattle to graze in the forest.

[36] The influence of podzolization during the twentieth century may have been less than before the historic sampling. The lower concentrations of organic carbon in the historic sample than in the modern sample may reflect a decreased input of organic matter (and organic acidity) to the soil that resulted from logging. Nevertheless, the soil continued to acidify to a depth of at least 40 cm. The increase in precipitation over the twentieth century may

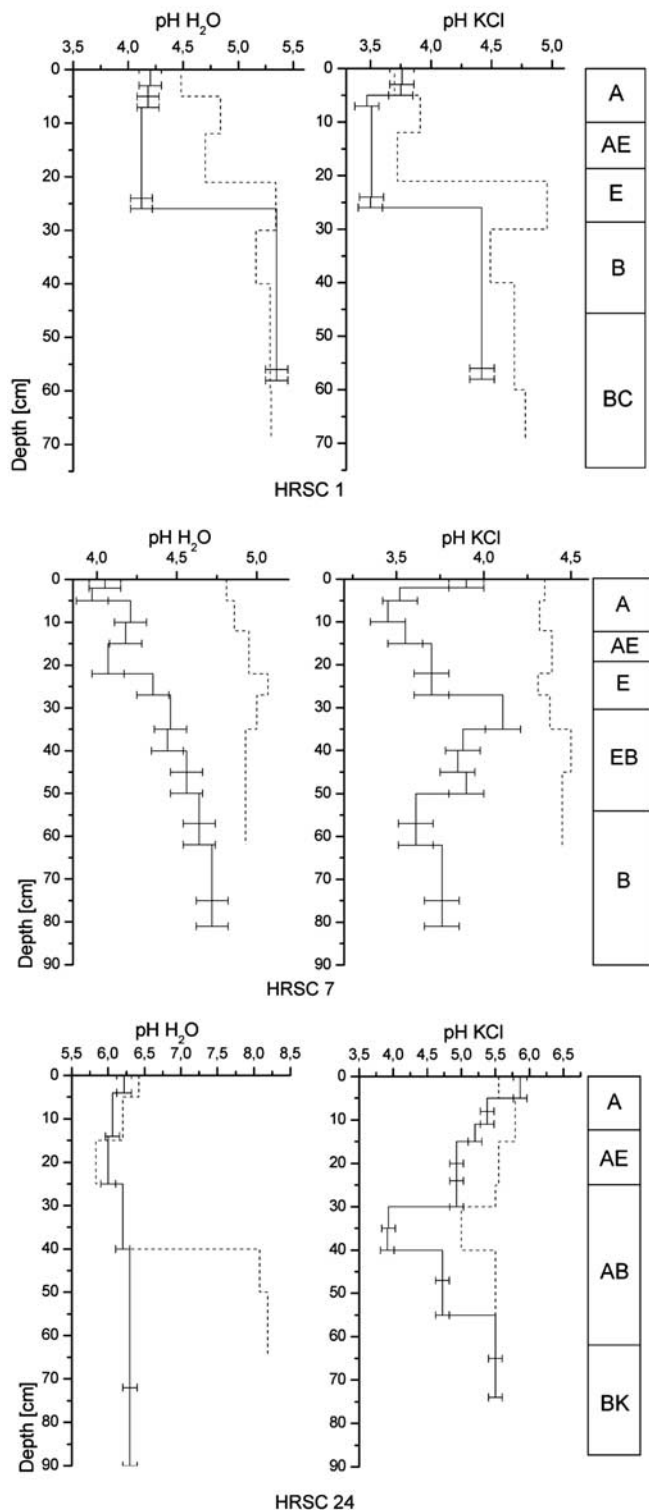

Figure 3. The pH of soil extracted with deionized water and 0.1 M KCl solutions at the three study sites. In all graphs, solid lines represent historic samples, and dashed lines represent modern samples. Error bars represent standard deviations of the mean of values from the primary pit, and four replicate pits, within 100 m of the primary pit. The lateral position of each graphed vertical line represents the measurement value. The height of each graphed vertical line represents the profile thickness of each sample.

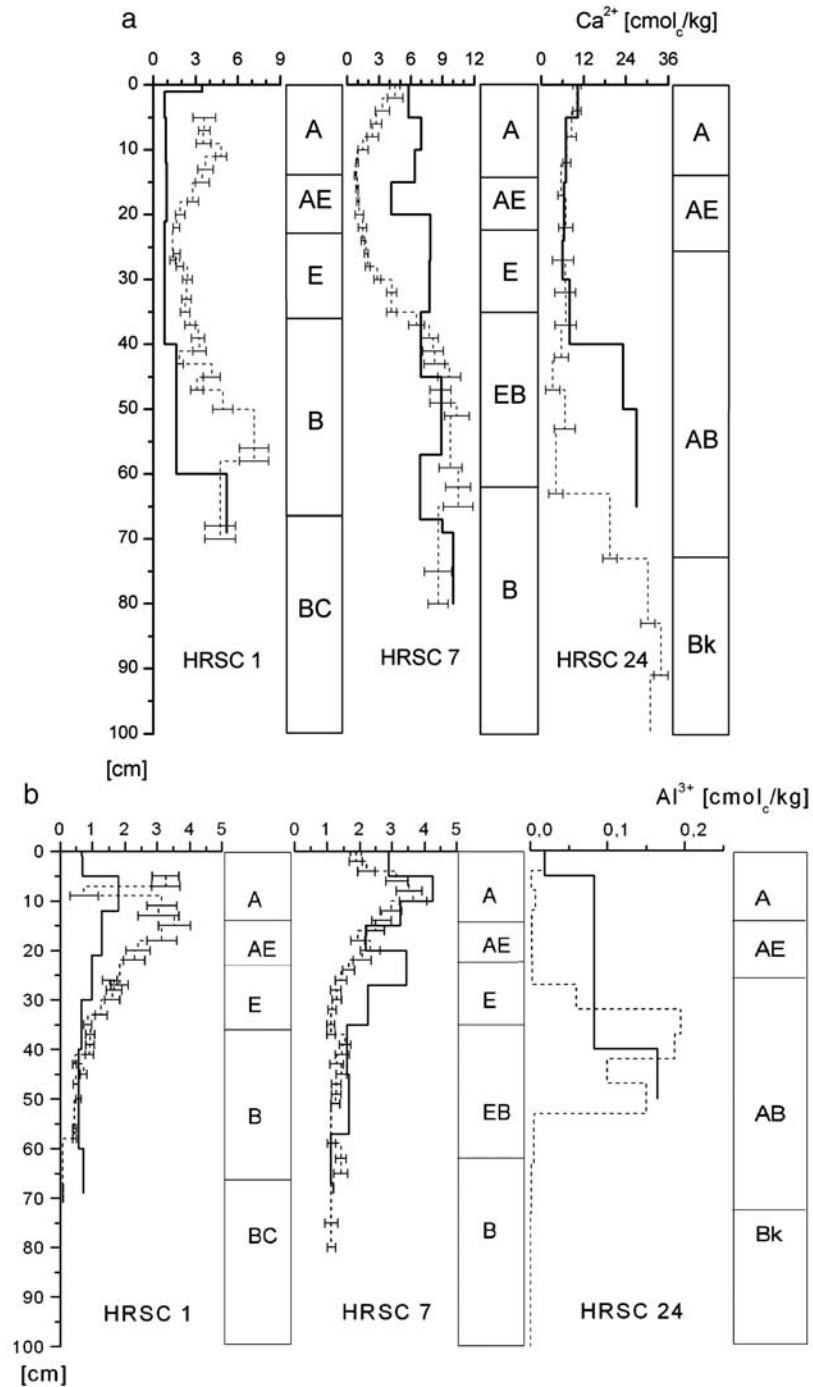

Figure 4. Concentration of (a) exchangeable CA and (b) exchangeable Al, at the three study sites.

have contributed to increased leaching in this well-drained soil, but the high level of acidic deposition at the site is likely to have been the major factor in further acidification. Substantial leaching between the two samplings is indicated by decreases in pH that approach 1 unit, decreases in exchangeable Ca from 6 to less than 1 [$\text{cmol}_c \text{kg}^{-1}$], and decreases in exchangeable Al concentrations in the E horizon. Although podzolization could be expected to lower concentrations of exchangeable Ca and Al in the E horizon,

the lack of illuviation of carbon below the E horizon in the modern samples suggests that strong acids from acidic deposition were an important factor in the decrease in concentration of these cations. Higher concentrations of total sulfur throughout the profile in the modern samples than in the historic samples, despite lower concentrations of organic carbon, are also consistent with atmospheric deposition effects [Lawrence, 2002], as are the Al:Ca ratios in the rooting zone of the modern samples, which fall in the

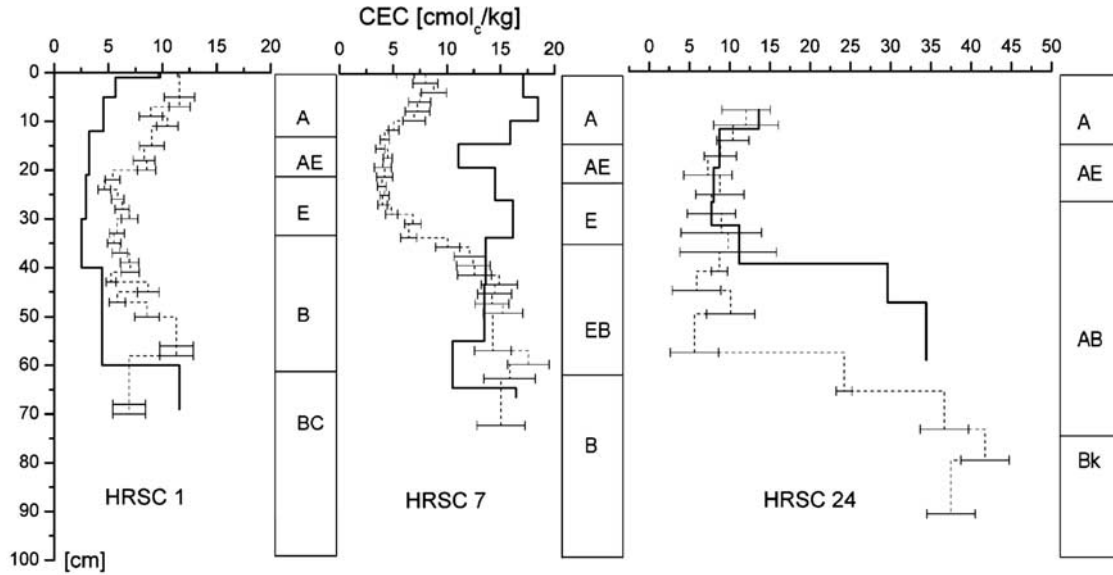

Figure 5. Cation-exchange capacity (CEC) at the three study sites.

range that was found to correlate with biochemical indicators of stress in red spruce ($Al:Ca > 0.5 \text{ mol mol}^{-1}$) in the northeastern United States [Shortle *et al.*, 1997]. The substantial decrease in pH may have enhanced SO_4^{2-} adsorption [Fuller *et al.*, 1985]. Decreased organic carbon concentrations and lower pH may have also led to decreased CEC in the upper profile.

[37] Despite considerable Ca depletion in the upper 40 cm of the profile, little or no depletion occurred below this depth. The most probable explanation for the abrupt change

in the depletion pattern is the existence of a fragipan between 30 and 40 cm depth. Bulk density reached a maximum of 1.6 g cm^{-3} in this depth interval. The high density of this layer undoubtedly restricted water flow and associated leaching of cations lower in the profile.

4.3. Site 24: Buffering of Moderate Acidic Deposition Levels

[38] During the twentieth century, Site 24 received inputs of atmospheric deposition that were considerably less than

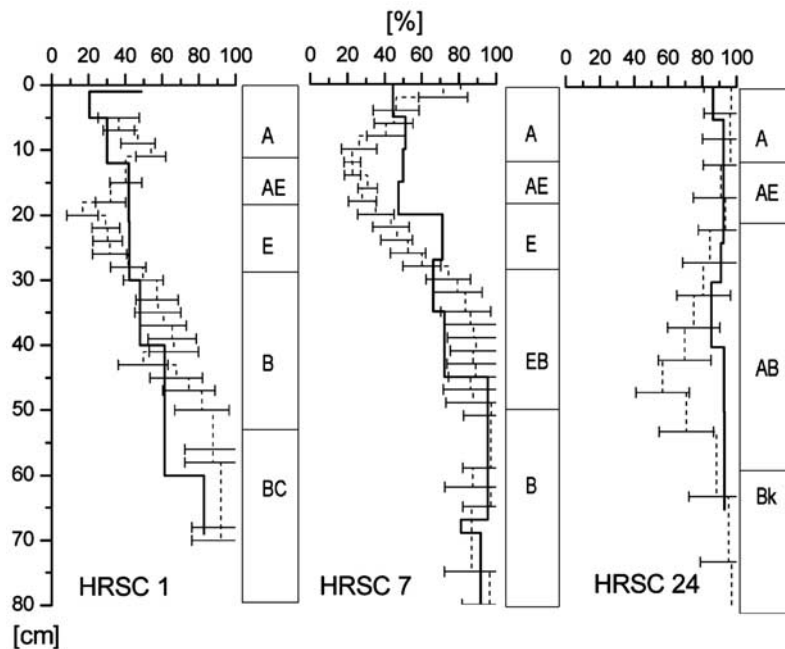

Figure 6. Exchangeable carbonate (Ca and Mg) concentrations, expressed as a percentage of cation-exchange capacity (CEC).

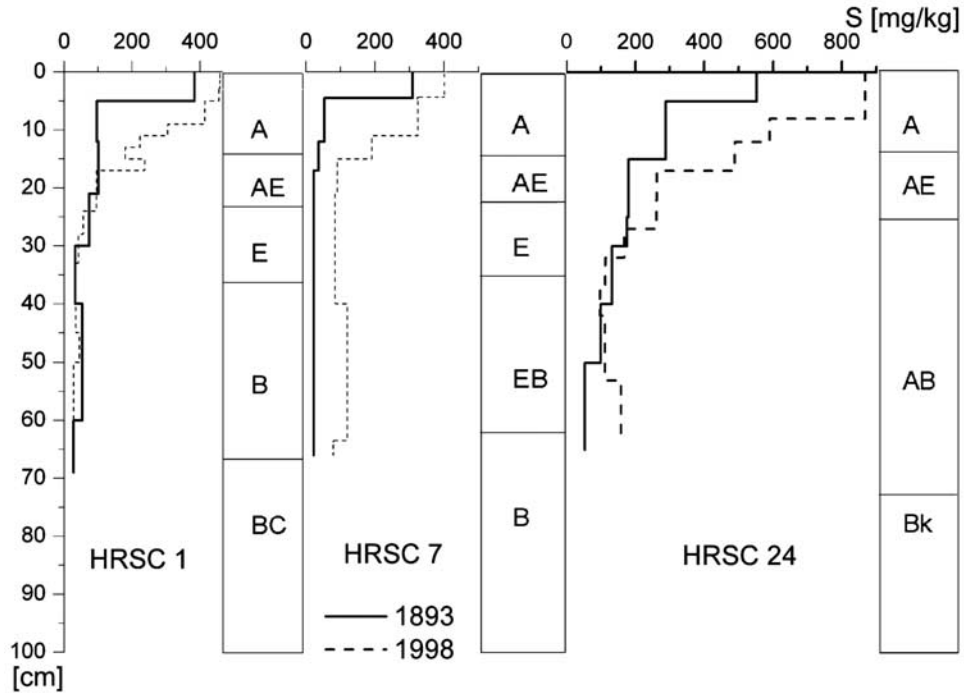

Figure 7. Total concentration of sulfur from main pits and historic samples at the three study sites.

Sites 1 and 7. At the time of the historic sampling, the soil at Site 24 was minimally acidic. Salt-extractable pH was 5.5 or higher through most of the profile, exchangeable carbonates as a percent of CEC was approximately 80%, and exchange-

able Al concentrations were an order of magnitude lower than at Site 1 or Site 7. Several centuries of forest growth resulted in higher concentrations of organic carbon than in soils of Sites 1 or 7. Organic acids derived from organic

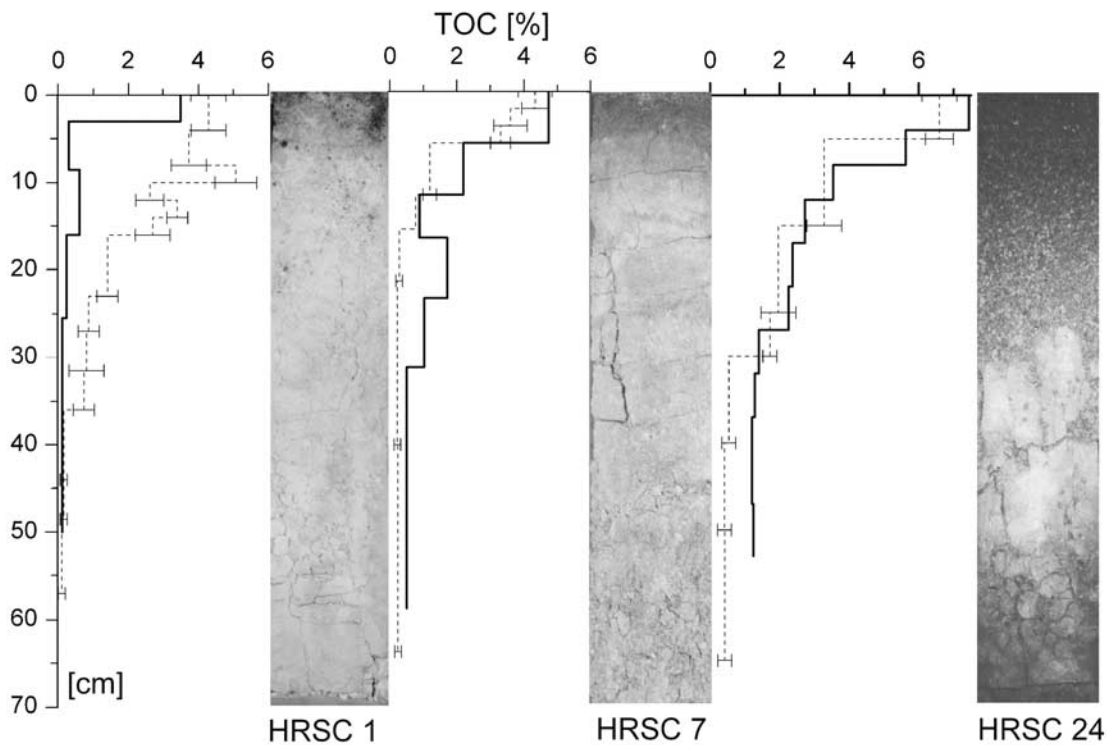

Figure 8. Concentrations of organic carbon at the three study sites. See color version of this figure at back of this issue.

matter are the most likely cause of lower exchangeable Ca concentrations in the upper 40 cm of the soil profile than below the 40 cm depth. Organic acids may also have led to lower exchangeable Al concentrations in the upper profile and deposition of Al deeper in the profile.

[39] A century of continued forest growth, increased precipitation, and relatively moderate acidic deposition resulted in limited changes in this well-buffered soil. The most significant difference in soil chemistry between the historic and modern samples was a decrease in exchangeable Ca from approximately 40 cm to 60 cm below the surface. No difference between the historic and modern samples in exchangeable Ca or water-extractable pH was measured in the top 40 cm of the profile, however, despite a decrease in salt-extractable pH. The weathering flux of the top 40 cm was sufficient to balance leaching losses at a concentration of exchangeable Ca between 6 to 8 [cmol_c kg⁻¹]. Continued leaching over the twentieth century lowered the weathering front approximately 20 cm deeper in the profile.

[40] In the absence of logging (other than thinning) since the 1880 clear-cut, organic carbon content changed little over the twentieth century. Concentrations of total sulfur in the upper 15 cm of the profile were higher in the modern samples than the historic samples, however, reflecting the increase in atmospheric deposition of sulfur in the twentieth century.

5. Conclusion

[41] Soils throughout much of western Russia have developed from fine-textured carbonate material that is considered to be an effective buffer against acidic deposition [Nikonov and Koptsik, 1999]. Nevertheless, some degree of acidification occurred over the twentieth century at each site. The changes in soil chemistry depended upon site history and climate, as well as acidic deposition levels, however. At Site 1, where soil had been previously acidified by agricultural practices, reforestation in the twentieth century resulted in an increase in Ca availability, despite the acidifying processes of net forest growth and acidic deposition. Increases in concentrations of exchangeable base cations offset, to some extent, depletion that occurred in the soil at this site prior to the historic sampling. This type of reforestation was common in the vicinity of small villages in western and northern Russia as agricultural practices shifted to the use of heavy machinery and collectivization, which tended to concentrate intensive agriculture in central locations. Reforestation may have provided a significant sink for atmospheric carbon during the twentieth century [Kolchugina et al., 1995].

[42] Sites 7 and 24 had similar concentrations of exchangeable Ca in the upper 35 cm of the profile at the time of the historic sampling, although salt-extractable pH was lower at Site 7 than Site 24. High inputs of acidic deposition during the twentieth century were most likely the primary cause of the considerable depletion of Ca that occurred in the upper profile at Site 7. The Ca:Al ratios in the rooting zone of the modern samples at Site 7 are in the range that was found to be related to stress in red spruce in the

northeastern United States [Shortle et al., 1997]. Soil at Site 24 was sufficiently buffered to prevent further depletion of Ca in the upper profile under relatively moderate acidic deposition levels, but downward movement of the weathering front in this profile did appear to occur.

[43] Comparison of soil chemistry before and after the twentieth century demonstrated that pronounced Ca depletion can occur within 100 years under high inputs of acidic deposition, even in soils developed from Ca-rich parent material. This result suggests that less buffered soils developed from silica-based parent material, common in northern Europe and eastern North America, have also experienced a significant reduction in Ca availability from acidic deposition, which has lowered their neutralizing capacity. Results also demonstrate that reforestation and changes in hydrology can influence soil chemistry within a century. Additional analysis of historic samples that are less than 100 years old will be necessary to determine the temporal pattern of changes during the twentieth century.

[44] **Acknowledgments.** We thank Boris Aparin, Vsevolod Aparin, Boris Babikov, and Anatoly Timofeev for help in field work. We also thank Mark David for S analysis and Scott Bailey and Mark David for helpful reviews of the manuscript. This work was supported by the NSF Ecosystem Studies Program under the grant 0089939, and partially by the Office of Science, U.S. Department of Energy under contract DE-AC03-76SF00098.

References

- Blume, L. J., et al. (1990), Handbook of methods for acid deposition studies: Laboratory analyses for soil chemistry, EPA/600/4-90/023, Environ. Monit. Syst. Lab., Las Vegas, Nev.
- Bobrov, A. A. (1995), Testate amoebae (Protozoa, Testacea) of Russia and Canada as indicators of climatic changes in Holocene, paper presented at International Conference on Past, Present and Future Climate, Finn. Res. Program on Clim. Change (SILMU), Helsinki.
- Bobrov, A. A., S. B. Yazvenko, and B. G. Warner (1995), Taxonomic and ecological implications of shell morphology of three testaceans (Protozoa: Rhizopoda) in Russia and Canada, *Arch. Protistenkd.*, 145, 119–126.
- Bobrov, A. A., D. J. Charman, and B. G. Warner (1999), Ecology of testate amoebae (Protozoa: Rhizopoda) on peatlands in western Russia with special attention to niche separation in closely related taxa, *Protist*, 150, 125–136.
- Bonnet, L., and R. Thomas (1960), Thecamoebiens du sol, in *Faune terrestre et d'eau douce des Pyrenees-Orientales, Ve Milieu*, 5, Suppl., 1–113.
- Buol, S. W., F. D. Hole, and R. J. McCracken (1980), *Soil Genesis and Classification*, ed. II, Iowa State Univ. Press, Ames, Iowa.
- Chardez, D. (1965), Ecologie générale des Thécamoebiens (Rhizopoda testacea), *Bull. Inst. Agron. Stn. Rech. Gembloux*, 33, 306–341.
- Chertov, O. G. (1990), Accumulation of sulfur in soil, in *Forest Ecosystems and Atmospheric Contamination*, edited by V. A. Alekseyev, pp. 73–75, Nauka, Leningrad, Russia.
- Crane, K., and J. L. Galasso (1999), Arctic environmental atlas, *Publ. 157*, Off. of Nav. Res., Nav. Res. Lab., Washington, D. C.
- Cvetkov, M. A. (1957), *Changes in Forest Cover of European Russia from the End of XVII Century to 1914*, USSR Acad. of Sci., Moscow.
- Cwynar, L. C., E. Burden, and J. H. McAndrews (1979), An inexpensive sieving method for concentrating pollen and spores from fine-grained sediments, *Can. J. Earth Sci.*, 16(5), 1115–1120.
- David, M. B., M. J. Mitchell, D. Aldcorn, and R. B. Harrison (1989), Analysis of sulfur in soil, plant and sediment materials: Sample handling and use of an automated analyzer, *Soil Biol. Biochem.*, 21, 119–123.
- Decloritte, L. (1981), Le genre *Trinema* Dujardin 1841, Révision à jour au 31.12.1979, *Arch. Protistenkd.*, 124, 193–218.
- Faegri, K., P. E. Kaland, and K. Krzywinski (1989), Textbook of pollen analysis, 4th ed., 348 pp., John Wiley, Hoboken, N. J.
- Fuller, R. D., M. B. David, and C. T. Driscoll (1985), Sulfate adsorption relationships in forested spodosols of the northeastern USA, *Soil Sci. Soc. Am. J.*, 49, 1034–1040.

- Georgievskii, V. Y., A. V. Ezhov, A. L. Shalygin, I. A. Shiklomanov, and A. I. Shiklomanov (1996), Assessment of the effect of possible climate changes on hydrological regime and water resources of rivers in the former USSR, *Russ. Meteorol. Hydrol.*, Engl. Transl., 11, 66–74.
- Groisman, P. Y. (1991), Data on present-day precipitation changes in the extratropical part of the Northern Hemisphere, in *Greenhouse-Gas-Induced Climatic Change: A Critical Appraisal of Simulations and Observations*, edited by M. E. Schlesinger, pp. 297–310, Elsevier Sci., New York.
- Groisman, P. Y., V. V. Koknaeva, T. A. Belokrylova, and T. R. Karl (1991), Overcoming biases of precipitation measurement: A history of the USSR experience, *Bull. Am. Meteorol. Soc.*, 72, 1725–1733.
- Horsley, S. B., R. P. Long, S. W. Bailey, and R. A. Hallett (1999), Factors contributing to sugar maple decline along topographic gradients on the glaciated and unglaciated Allegheny Plateau, in *Sugar Maple Ecology and Health: Proceedings of an International Symposium, 1998 June 2–4, Warren, Pa.*, edited by S. B. Horsley and R. P. Long, *Gen. Tech. Rep. NE-261*, pp. 60–62, U.S. Dep. of Agric., For. Serv., Northeastern Res. Stn., Newtown Square, Pa.
- Ivanov, V. A. (1991), 100 years of observations at Kamennaya Steppe National Park (in Russian), Kamennaya Steppe technical report, pp. 102–147, Inst. of Agric. of Central Chernozemic Dist., Kamennaya Steppe, Russia.
- Johnson, A. H., S. B. Anderson, and T. G. Siccama (1994), Acid rain and soils of the Adirondacks: I. Changes in pH and available calcium, *Can. J. For. Res.*, 24, 193–198.
- Kolchugina, T. P., T. S. Vinson, G. G. Gaston, V. A. Rozkov, and A. Z. Shvidendo (1995), Carbon pools, fluxes, and sequestration potential in soils of the former Soviet Union, in *Soil Management and the Greenhouse Effect*, edited by R. Lal et al., pp. 25–40, CRC, Boca Raton, Fla.
- Laminger, H. (1978), The effects of soil moisture fluctuations on the testatean species *Trinema enchechys* (Ehrenberg) Leidy in a high mountain brown-earths-podzol and its feeding behavior, *Arch. Protistenkd.*, 20, 446–454.
- Lapenis, A. G. (2002), Directed evolution of the biosphere: Biogeochemical selection or Gaia?, *Prof. Geogr.*, 54(3), 379–391.
- Lapenis, A. G., M. S. Torn, J. W. Harden, K. Hollocker, B. V. Babikov, A. I. Timofeev, M. I. Hornberger, and R. Nattis (2000), Scientists unearth clues to soil contamination by comparing old and new samples, *Eos Trans AGU*, 81(53), 59–60.
- Lawrence, G. B. (2002), Persistent episodic acidification of streams linked to acid rain effects on soil, *Atmos. Environ.*, 36, 1589–1598.
- Lawrence, G. B., M. B. David, G. M. Lovett, P. S. Murdoch, D. A. Burns, J. L. Stoddard, B. P. Baldigo, J. H. Porter, and A. W. Thompson (1999), Soil calcium status and the response of stream chemistry to changing acidic deposition rates in the Catskill Mountains of New York, *Ecol. Appl.*, 9, 1059–1072.
- Likens, G. E., C. T. Driscoll, and D. C. Buso (1996), Long-term effects of acid rain: Response and recovery of a forest ecosystem, *Science*, 272, 244–246.
- Markewitz, D., D. D. Richter, H. L. Allen, and J. B. Urrego (1998), Three decades of observed soil acidification in the Calhoun Experimental Forest: Has acid rain made a difference?, *Soil Sci. Soc. Am. J.*, 62, 1428–1439.
- Myasoedov, S. S., Y. L. Kiryukov, and K. V. Kryzhanovsky (1969), *Shipov Forest: The Survey of Research and Publications*, Voronezh Univ. Publ., Voronezh, Russia.
- Nikonov, V. V., and G. N. Koptsik (1999), Acid rains and forest soils, 320 pp., Kola Sci. Cent. of the Russ. Acad. of Sci., Apatity, Russia.
- Pantuyukhin, A. I. (1973), Soils of Ladoga-Volkhov Plateau, in *Soils of Leningrad Region*, edited by V. K. Pestryakov, pp. 229–252, Lenizdat, Leningrad, Russia.
- Reuss, J. O., et al. (1990), Aluminum solubility, calcium-aluminum exchange, and pH in acid forest soils, *Soil Sci. Soc. Am. J.*, 54, 374–380.
- Roskomgidromet (2000), Obzor zagriaznenia prirodnoi sredy v Rossiskoi Federatsii za 1999 god (Report on contamination of environment in Russian Federation in 1999), report, Moscow.
- Sergeev, E. M. (1984), *Soil and Geologic Strata of Nonchernozemic Region* (in Russian), 608 pp., Moscow Univ. Press, Moscow.
- Shahgedanova, M. (2003), Climate at present and in the historic past, in *The Physical Geography of Northern Eurasia*, chap. 3, pp. 70–103, Oxford Univ. Press, New York.
- Shortle, W. C., K. T. Smith, R. Minocha, G. B. Lawrence, and M. B. David (1997), Acidic deposition, cation mobilization, and biochemical indicators of stress in healthy red spruce, *J. Environ. Qual.*, 26, 871–876.
- Tamm, C. O., and L. Hallbacken (1986), Changes in soil pH over a 50-year period under different forest canopies, in SW Sweden, *Water Air Soil Pollut.*, 31(1–2), 337–341.
- Thomas, G. W. (1982), Exchangeable cations, in *Methods of Soil Analysis, Part 2*, 2nd ed., edited by A. L. Page, R. H. Miller, and D. R. Keeney, pp. 159–166, Soil Sci. Soc. of Am., Madison, Wis.
- Tolonen, K. (1986), Rhizopod analysis, in *Handbook of Holocene Palaeoecology and Palaeohydrology*, edited by B. E. Berglund, pp. 645–666, John Wiley, New York.
- Torn, M., A. G. Lapenis, J. Harden, A. Timofeev, B. V. Babikov, and S. Savitzkaya (2002), Soil carbon cycling in the Russian Steppe: Radio-carbon analysis of modern and historic Russian soils, *Global Change Biol.*, 8, 941–953.
- Uspensky, V. V. (1997), *History of Forest Industry in Russia* (in Russian), 47 pp., Voronezh Acad. of For., Voronezh, Russia.
- Wesselink, L. G., K.-L. Meiwes, E. Matzner, and A. Stein (1995), Long-term changes in water and soil chemistry in spruce and beech forests, Solling, Germany, *Environ. Sci. Technol.*, 29, 51–58.

A. A. Andreev, Alfred Wegener Institute for Polar and Marine Research, D-14473 Potsdam, Germany. (aandreev@awi-potsdam.de)

A. A. Bobrov, Department of Geography, Moscow State University, Vorobyevy Gory, Moscow 119899, Russia. (anatoly@bobrov.soils.msu.ru)

J. W. Harden, U.S. Geological Survey, 345 Middlefield Road, MS 962, Menlo Park, CA 94025, USA. (jharden@usgs.gov)

A. G. Lapenis, Department of Geography and Planning, Department of Earth and Atmospheric Sciences, State University of New York at Albany, NY 12222, USA. (alapenis@albany.edu)

G. B. Lawrence, U.S. Geological Survey, Troy, NY 12180, USA. (glawrenc@usgs.gov)

M. S. Torn, Lawrence Berkeley National Laboratory, One Cyclotron Road, MS 90-1116, Berkeley, CA 94720, USA. (mstorn@lbl.gov)



Figure 1. Locations of three Historic Russian Soil Collection (HRSC) sites and direction of prevailing winds according to *Shahgedanova* [2003].

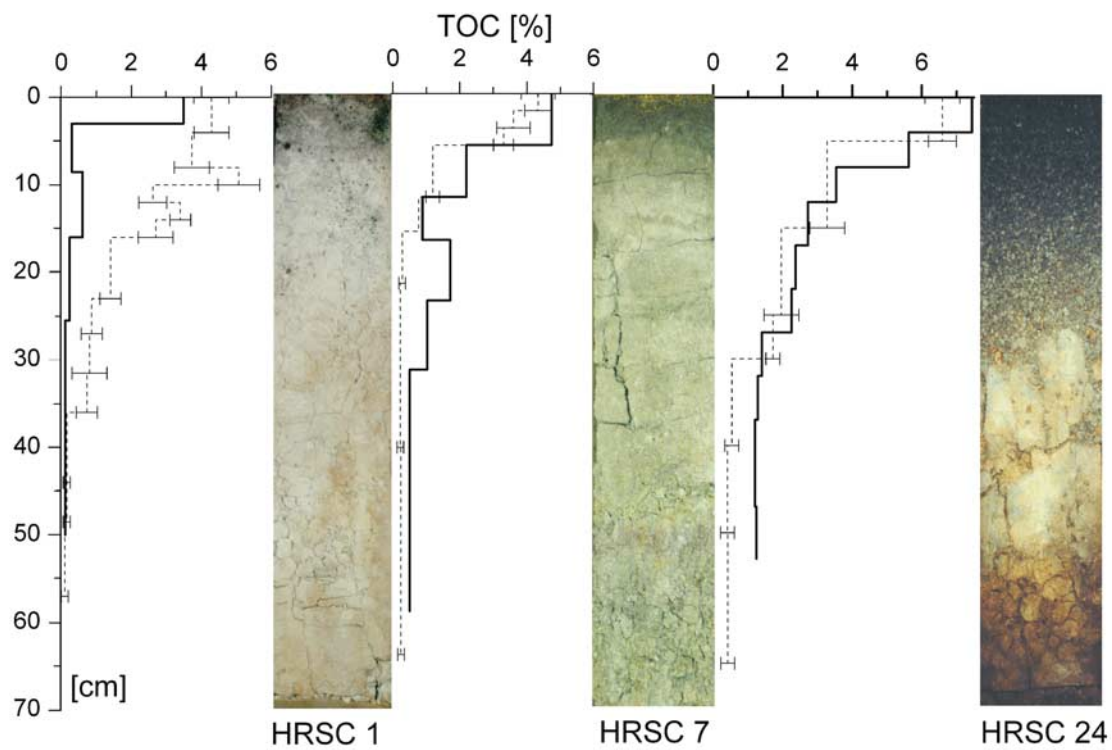

Figure 8. Concentrations of organic carbon at the three study sites.