

The Cryosat land ice validation experiment CryoVex2004

Part I: ASIRAS vs. laser altimeter measurements



Veit Helm, Wolfgang Rack

Alfred Wegener Institute for Polar and Marine Research
Am Alten Hafen 26, D-27568 Bremerhaven, Germany
email: vhelm@awi-bremerhaven.de

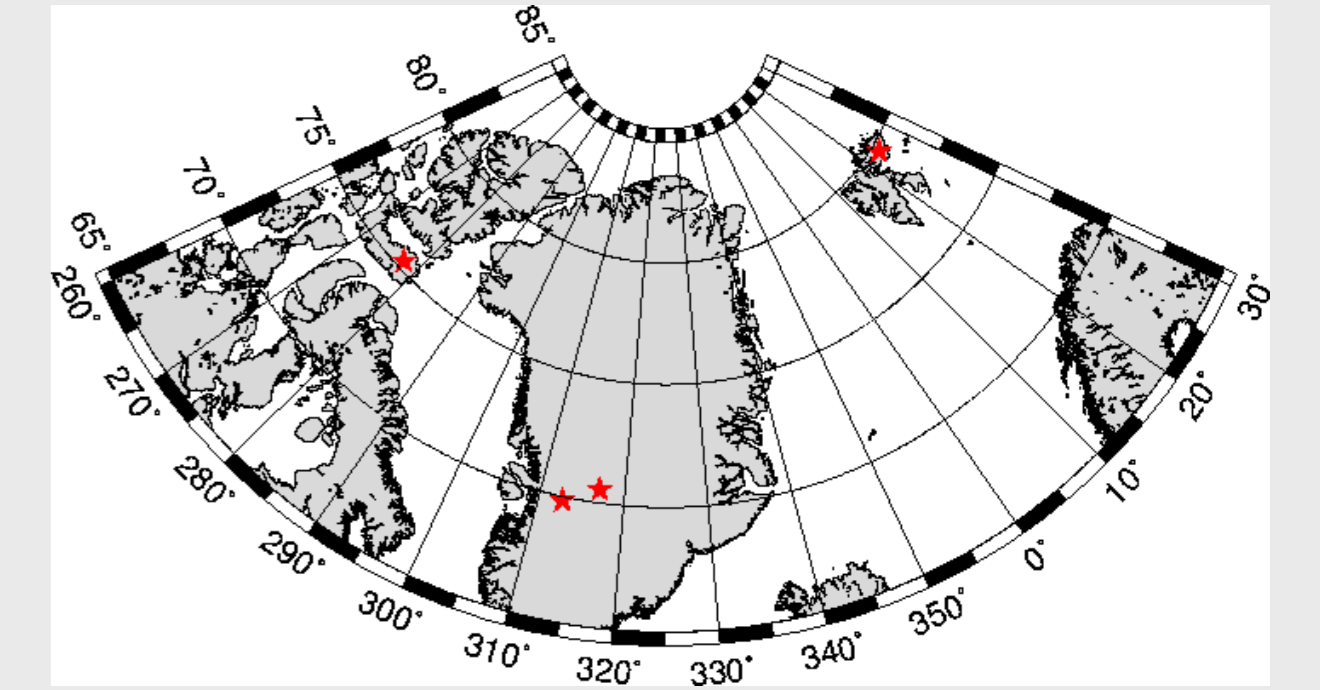

Introduction:

The purpose of the CryoSat altimeter mission was to determine trends in the ice masses of the Earth over a period of ~3 years. Although the launch failed in October 2005 the scientific objectives of the CryoVex validation experiments are still of undiminished importance. CryoVex activities included both ground-based and airborne campaigns. We will present the airborne data processing and calibration & validation results. The primary goal of CryoVex2004 was to provide coincident laser and interferometric radar altimeter measurements, in order to understand the penetration of CryoSat radar signal into polar sea ice and continental ice caps and to quantify uncertainty in the CryoSat measurements.

Austfonna Ice Cap CryoVex 2004A - 040420

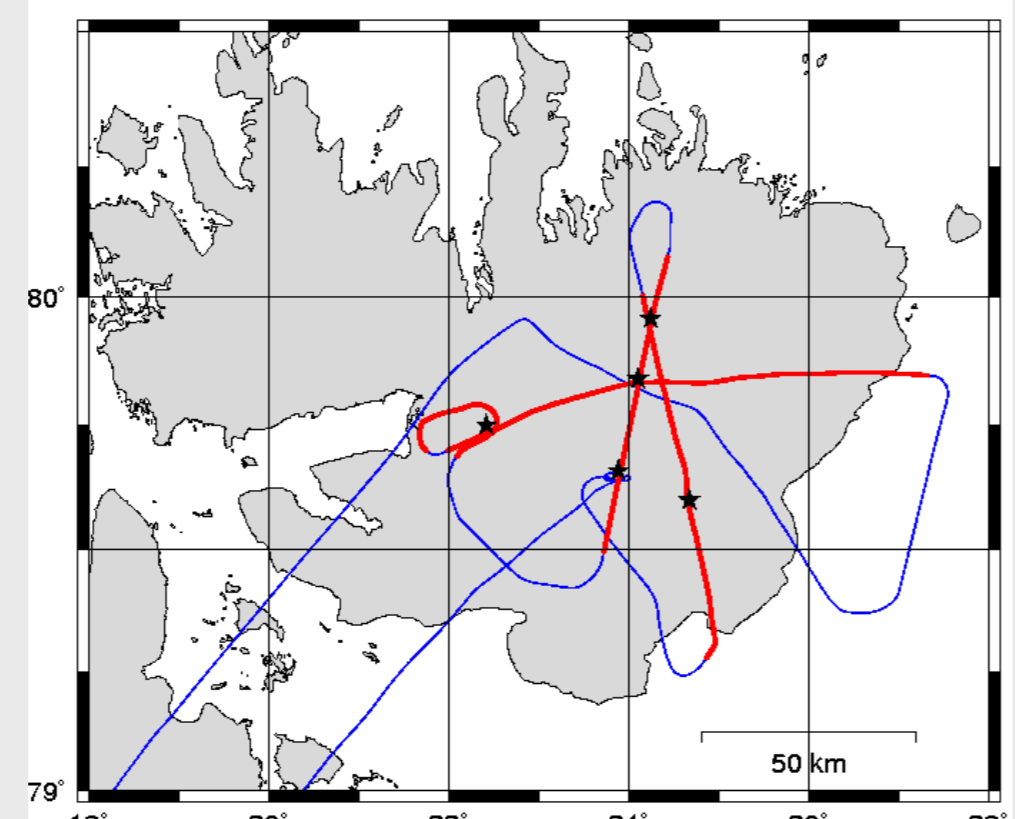

Figure 1: Map of DGPS (blue) and ASIRAS (red) profiles at 20th April 2004

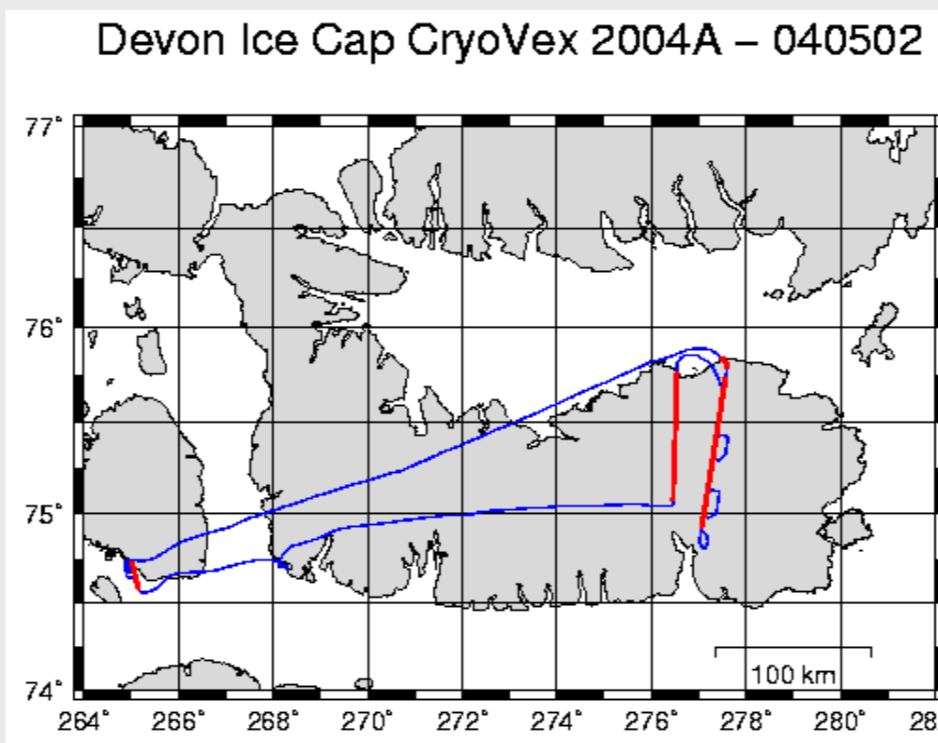

Figure 2: Map of DGPS (blue) and ASIRAS (red) profiles at 2nd May 2004

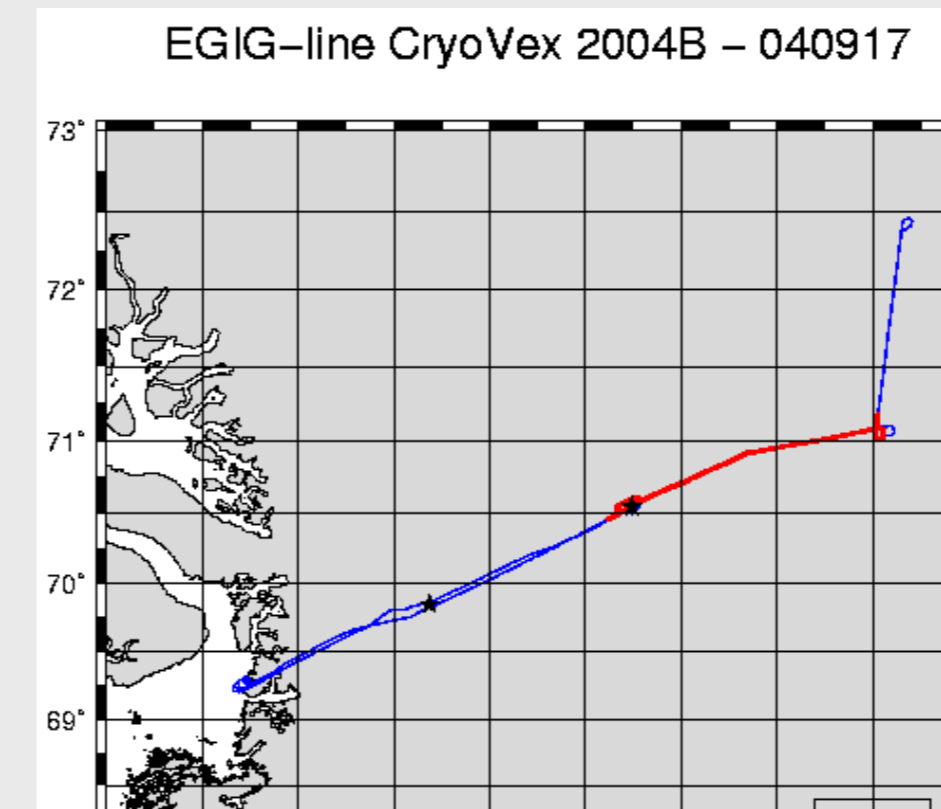

Figure 3: Map of DGPS (blue) and ASIRAS (red) profiles at 17th Sep. 2004

For redundant calibration purposes the German aircraft Polar 4 is equipped with a laser scanner, the ASIRAS instrument (Airborne SAR Interferometric Radar Altimeter System), a single-beam laser and two DGPS receivers.

During CryoVex 2004 two campaigns took place. Flights were performed in Svalbard across Austfonna (Figure 1), on the Greenland Ice Sheet along the EGIS line (Figure 3) and on Devon ice cap (Canadian Arctic, Figure 2). For calibrating the system runway over flights and corner reflector cross flights were performed. We will demonstrate the extensive calibration processing flow (Figure 4) and focus at squint angle and time shift problems between the instruments.

Processing:

For calibration and validation of ASIRAS a precise digital elevation model (DEM) of the measured profiles is required. This DEM is calculated from the Airborne Laser Scanner (ALS) data, which is measured with the Riegl - LMSQ280 instrument. The reference DEM (ALS-DEM) is calculated on a 1x1 m grid using a trigrid delaunay triangulation. After DGPS and ALS_L1 pre processing, it is necessary to calibrate the measurement system. This includes corrections for possible time shifts and inevitable installation inaccuracies (squint angles) in the aircraft (see red box). This procedure is required for every device. After applying these corrections to the ALS and the Single Beam Laser (LD90) the calibration of the ASIRAS with the ALS-DEM is possible. For calibrating the ASIRAS and LD90 a couple of runway over flights were flown.

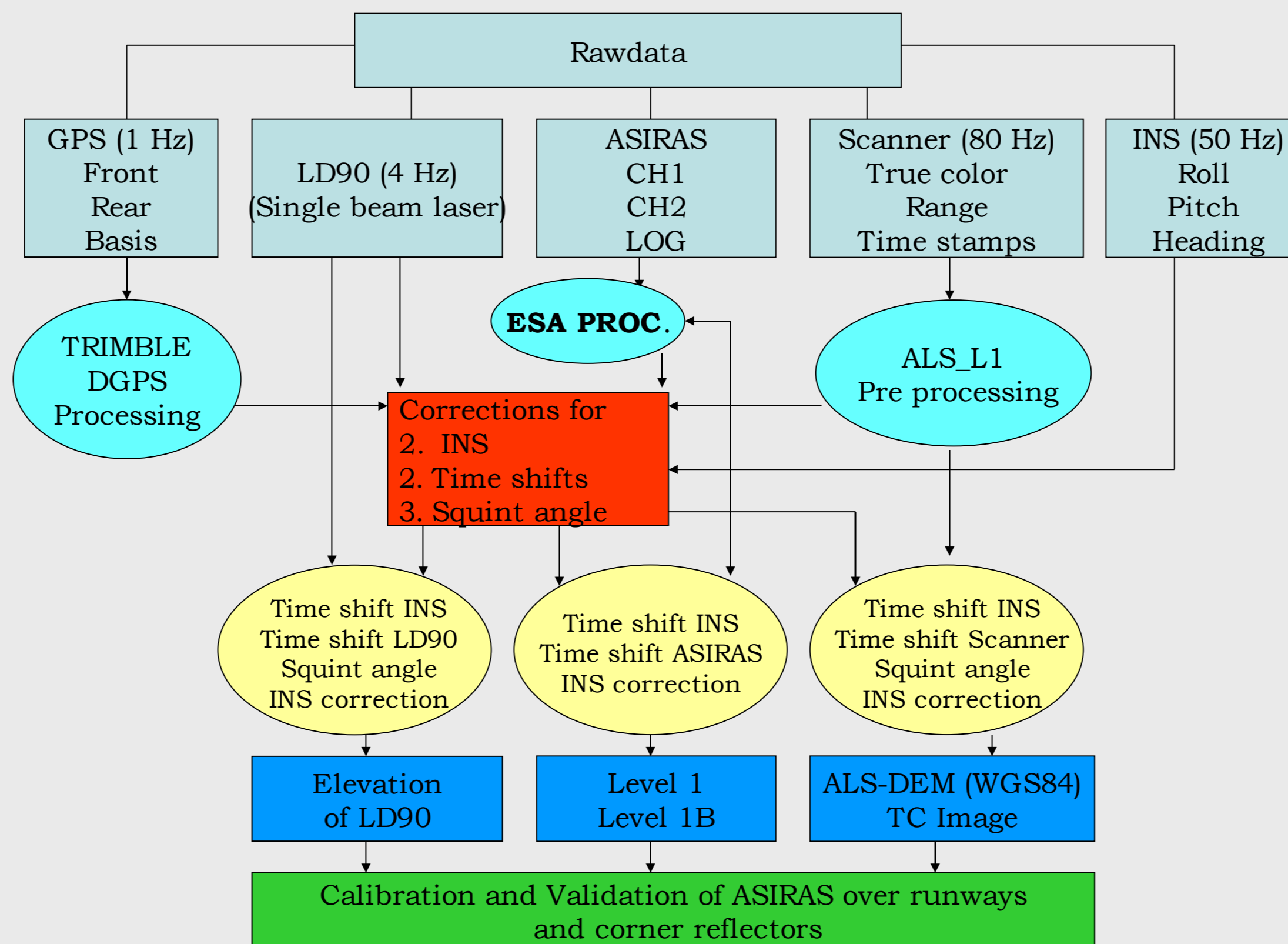

Figure 4: Cal/Val processing flow of ASIRAS

The flow chart in Figure 4 shows the content of the whole processing scheme. In the following calibration/validation box two main tasks are of special importance:

- Determination of device dependent time shifts
- Determination of squint angles of ALS (airborne laser scanner) and LD90 (single beam laser)

In defining time shifts a cross correlation of profile intervals of GPS-derived parameters and true instrument parameters (e.g. pitch rate, vertical velocity, rate of change in elevation) are performed. Second method, a Newton approximation between ALS-DEM and derived elevation, is used only for ASIRAS and LD90 (see Figure 5). Figure 7 shows the Ilulissat runway before and after time shift correction.

In defining squint angles cross flights over hangar buildings are performed. To minimize the distance between hangar edges determined in each cross flight a Newton approximation is applied, see Figure 6. Figures 7,8 are showing overlaid hangar buildings before and after applying the squint angle correction.

The obtained values are used as correction constants in the processing flow.

Concept of the determination of time shifts:

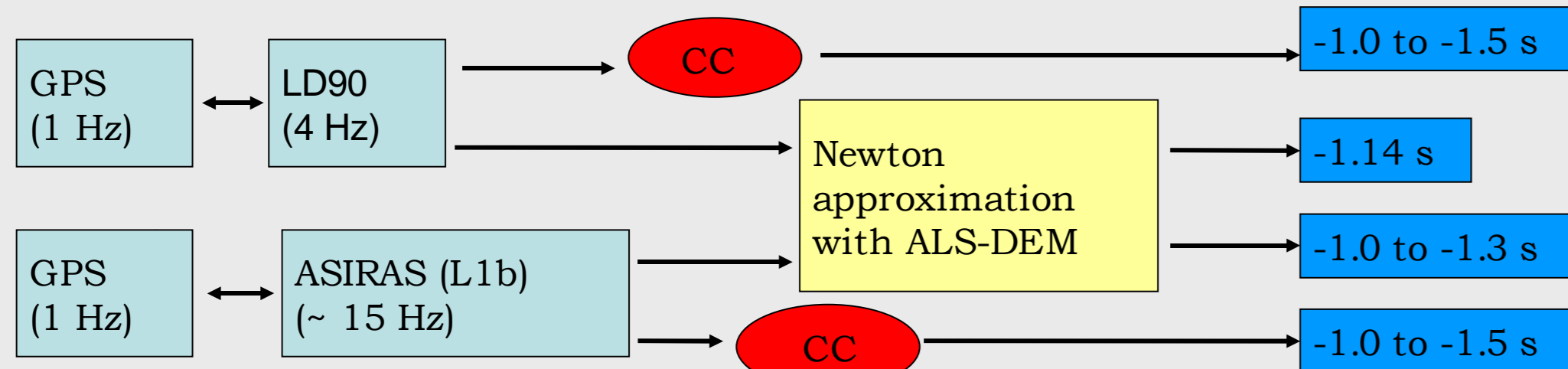

Figure 5: Concept of the determination of time shifts

Concept of the determination of squint angles:

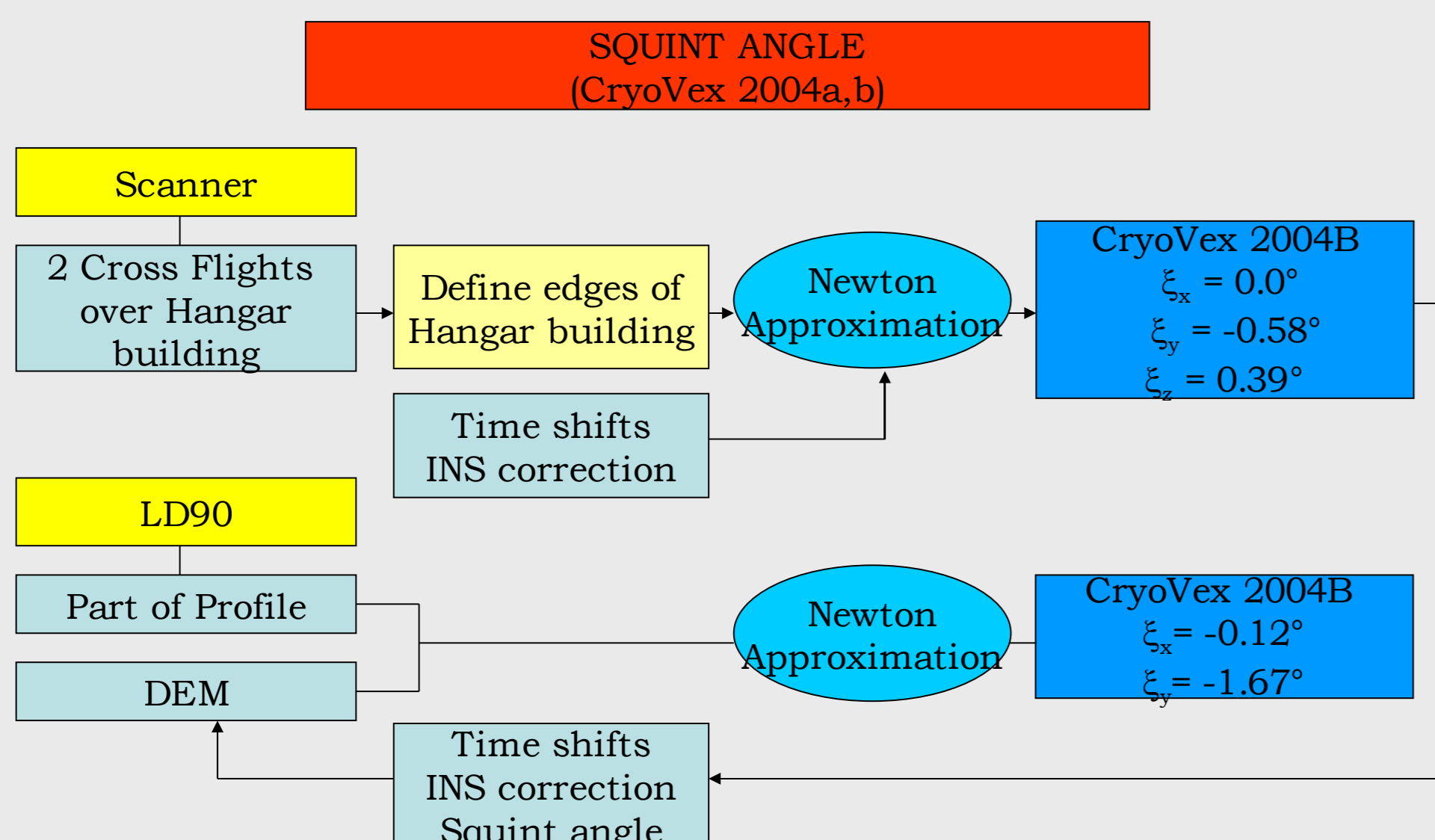

Figure 6: Concept of the determination of squint angles

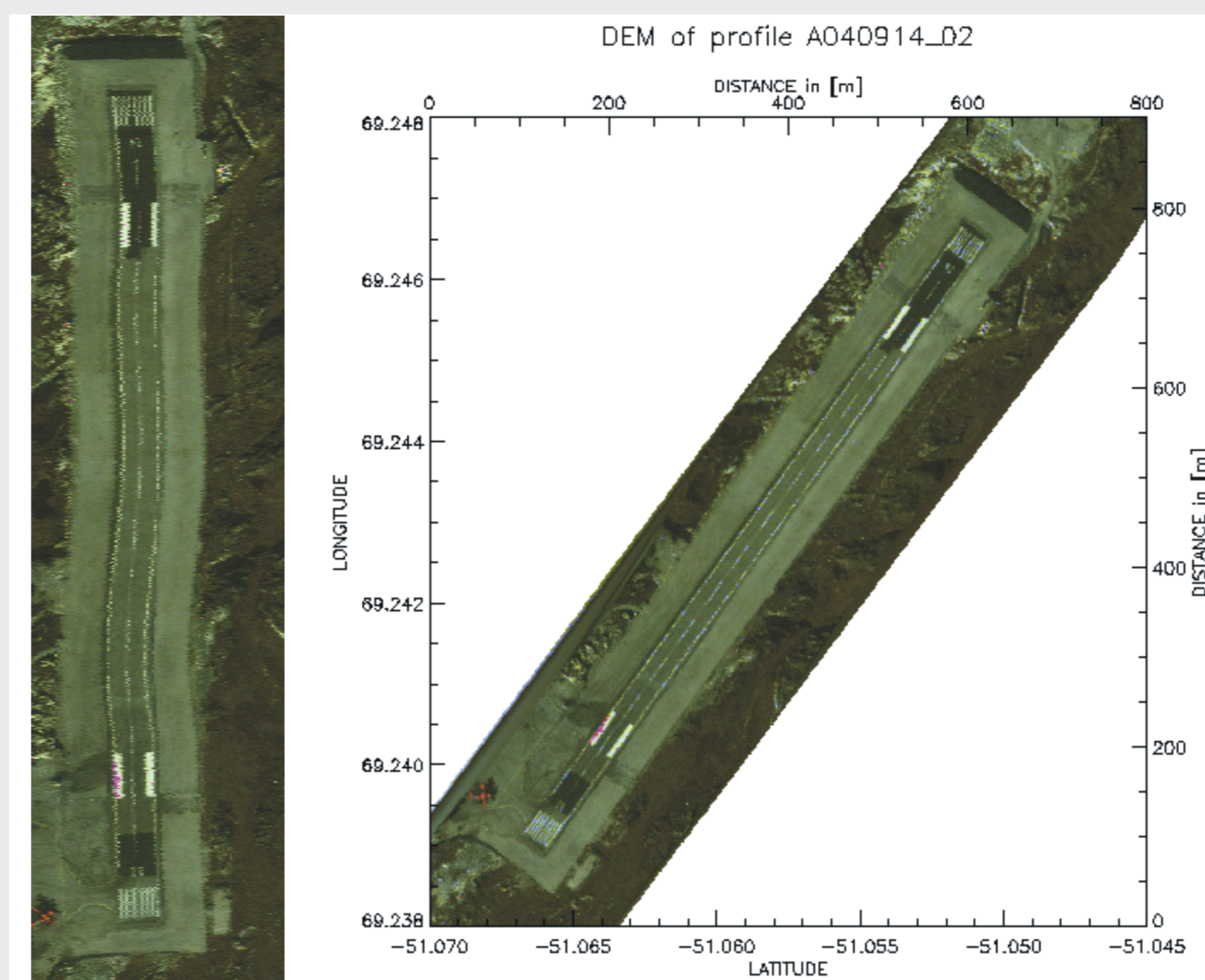

Figure 7: Runway Ilulissat before and after time shift correction. Map projection is UTM with respect to WGS84.

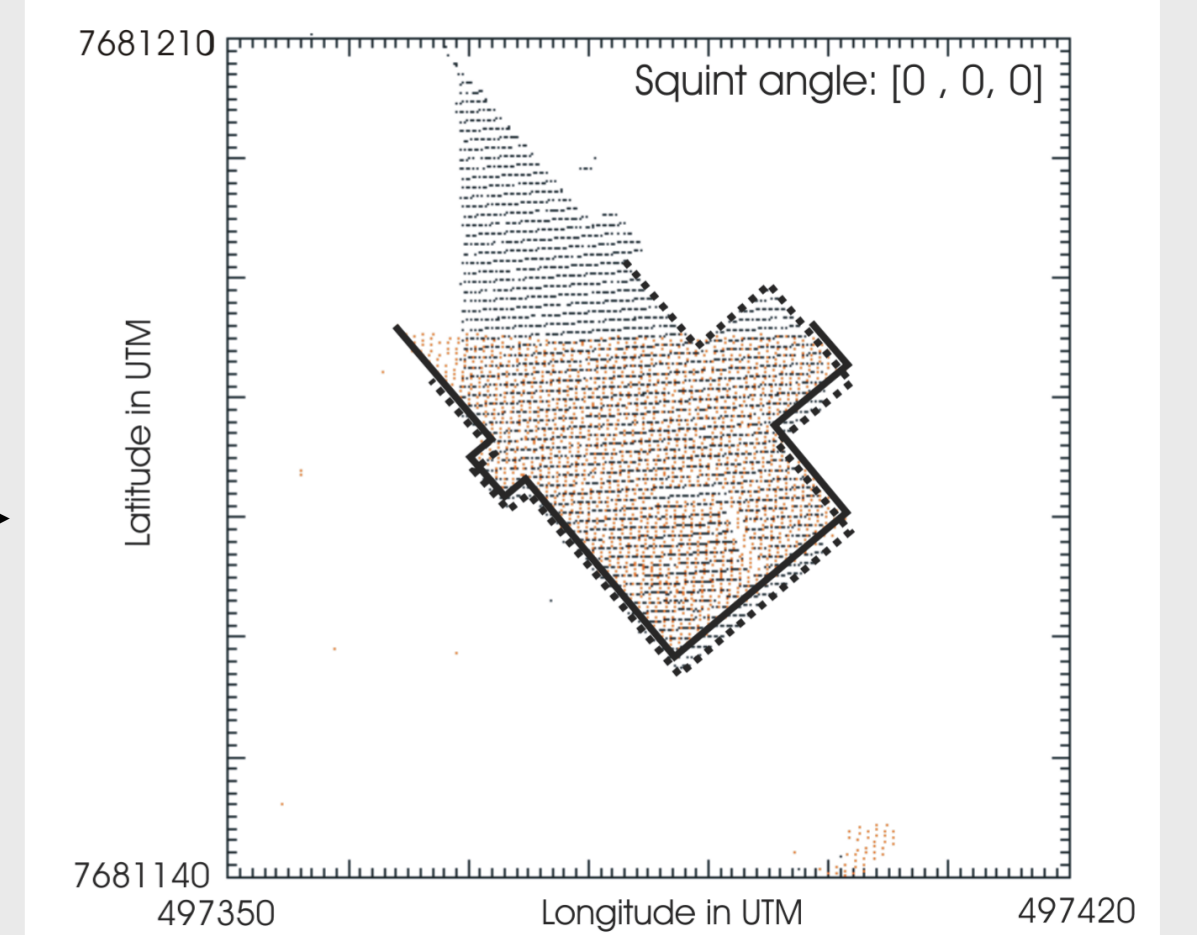

Figure 8: Overlaid hangar buildings before squint angle correction

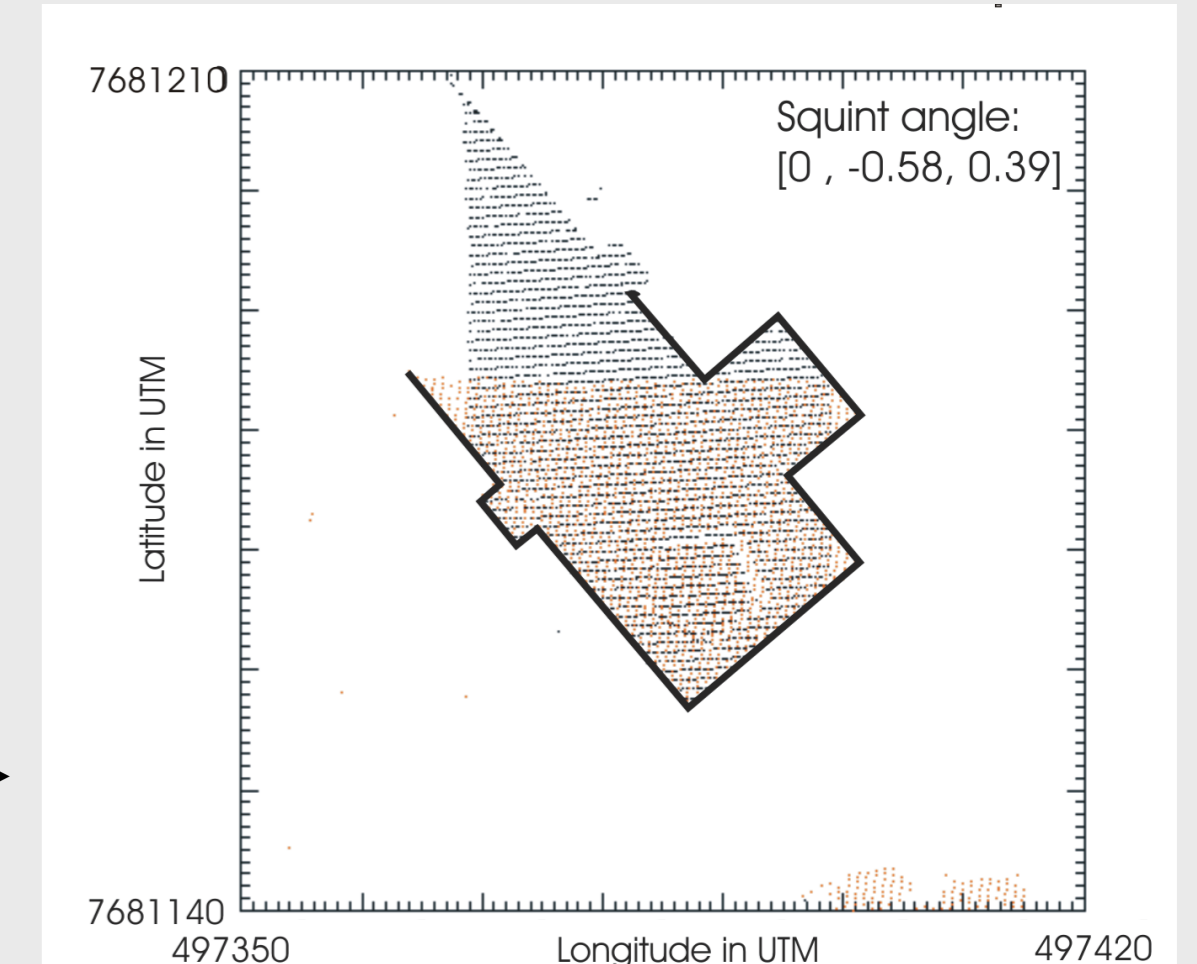

Figure 9: Overlaid hangar building after squint angle correction

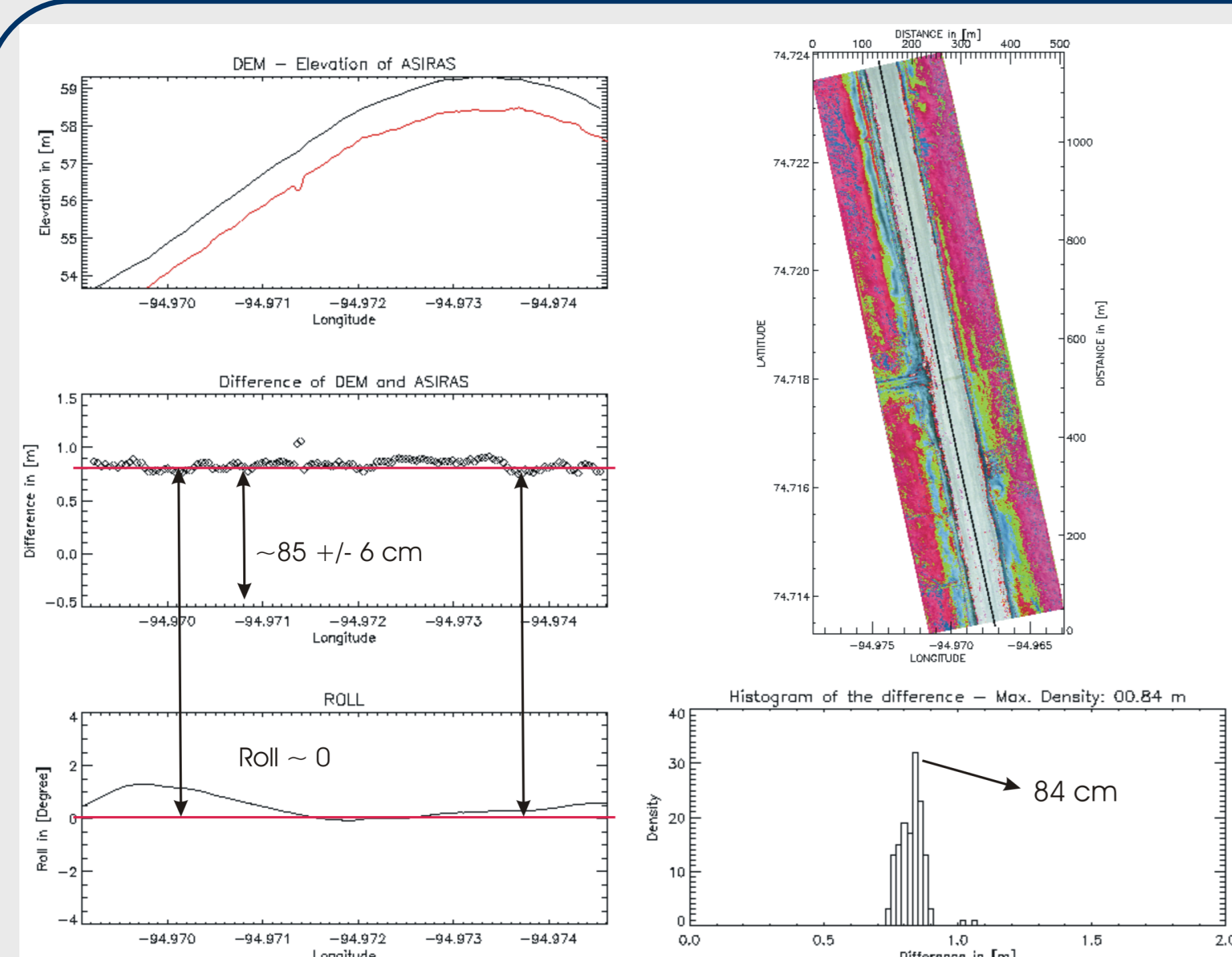

Figure 10: Runway overflight at Resolute Bay

Calibration of ASIRAS:

In order to calibrate the ASIRAS instrument runways were chosen as target assuming no penetration for both the radar and the laser. The true color image at the right hand side of Figure 10 shows an overflight over the runway in Resolute Bay at May 2, 2004. The difference plot of ASIRAS and ALS-DEM subtrack surface elevation (Figure 10, left hand side box 2 and histogram) shows a constant offset of ~85 cm, due to unknown instrument characteristics (e.g. cable length). It is likely that the energy of the radar return is affected by echoes reflected from rough snow beside the runway. This as well as high roll affects the radar waveform and therefore reduces the quality of the retracked surface elevation.

Validation of ASIRAS:

Flight activities during the CryoVex 2004 campaigns included over flights of corner reflectors (Figure 12). An example for the Austfonna Icecap is shown in Figure 11. In Figure 13 a strong corner reflector response is visible in the power echo. The surface response echo is strongly diluted and divided into two peaks, which results in a high uncertainty of tracking the surface. In this case the smaller, first peak was taken and the peak to peak difference is determined to 1.67 m. The ground team measured the corner reflector height above the snow surface with 1.56 m, which yields a penetration depth of the radar echo at CRY-3 of 0.11 m.

Austfonna Ice Cap CryoVex 2004A - 040425



Figure 11: Corner reflector CRY-3

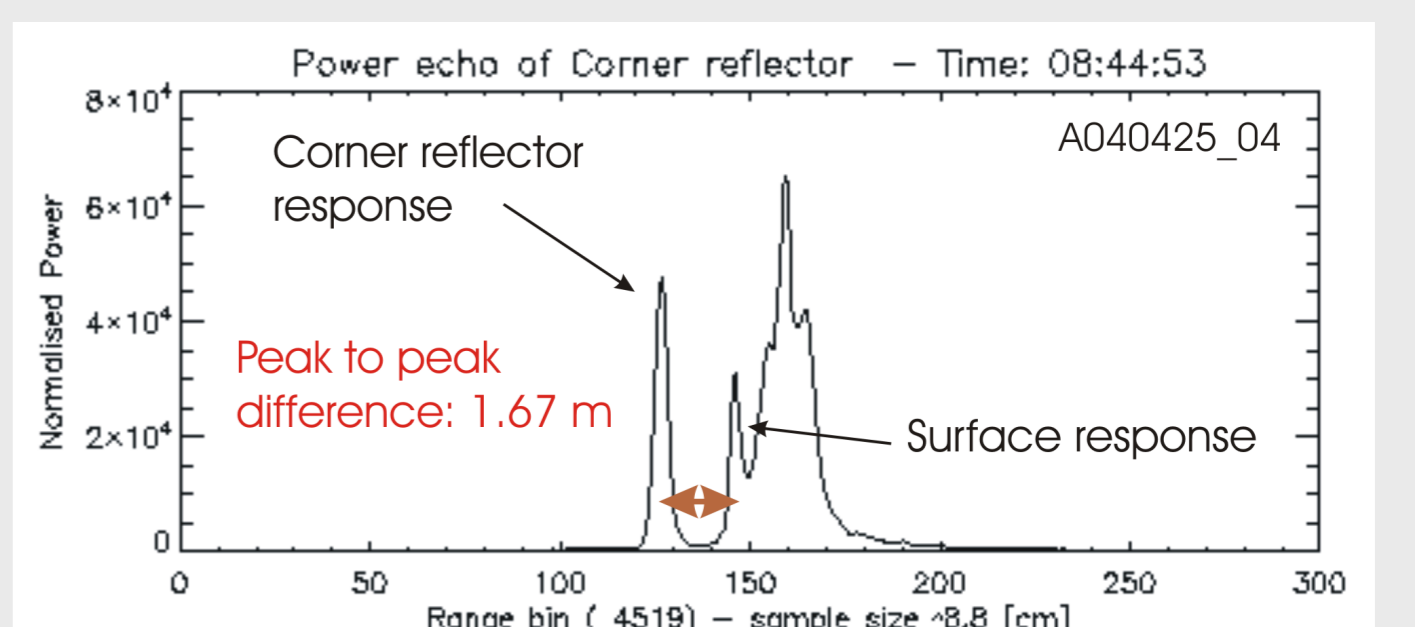

Figure 13: Power echo of corner reflector CRY-3