

## From Georg Forster Station to Neumayer Station III – a Sustainable Replacement at Atka Bay for Future

by Hartwig Gernandt<sup>1</sup>, Saad El Naggar<sup>1</sup>, Jürgen Janneck<sup>1</sup>,  
Thomas Matz<sup>1</sup> and Cord Drücker<sup>1</sup>

**Summary:** Polar research in the Federal Republic of Germany was given a central institution for the coordination and performance of essential scientific tasks in the polar regions by the foundation of the Alfred Wegener Institute for Polar Research (AWI) in 1980 – later Alfred Wegener Institute for Polar and Marine Research. Consultative Status in the Antarctic community was achieved in 1981 after the Georg von Neumayer Station (GvN), a permanently manned below-ground tube facility, was built and commissioned on Ekström Ice Shelf. Because the lifetime of underground buildings in snow is limited, especially when situated on an ice shelf, the station had to be replaced by the present Neumayer Station (NM-II) in 1992. Meanwhile the service life of NM-II is approaching its end, and a new station – Neumayer Station III (NM-III) – with very innovative design will be erected close to its two predecessors during the austral summers 2007/2008 and 2008/2009.

Research priorities at the present station are in the fields of meteorology, geophysics, and air chemistry. The respective observatory programs have been carried out continuously since March 1981. In 2003 the I27DE Infrasonic Array was installed as part of the international monitoring system of the Comprehensive Nuclear-Test-Ban Treaty Organisation (CTBTO). During austral summer 2005/2006 a new outside facility – the Perennial Acoustic Observatory in the Antarctic Ocean (PALAOA) – was set up completing the multidisciplinary research program. PALAOA is located as close as possible to the edge of the ice shelf, where long-term hydro-acoustic recordings from the Southern Ocean will be obtained.

All observatory programmes at Neumayer II are integrated into quite a number of international networks for scientific and with I27DE even for political objectives. During the past 25 years very valuable, unique time series have been recorded the quality of which is highly recognised in the international context. Therefore the intention is to keep the observatories with their outside facilities operational by advanced equipment and to continue feeding international networks with high quality data records.

The continuation of the observations at the same location, i.e. on the Ekström Ice Shelf, is thus of great importance and one of the main reasons for the rebuilding project. The other reason is given by the logistic tasks of the base. Over the recent years NM-II has developed into a significant logistic centre serving field expeditions and air missions for German research activities as well as providing support to other national programs in the area of Dronning Maud Land (DML) and beyond during austral summer periods. NM-II runs a snow runway and ground service equipment for aircraft operation. A considerable fleet of tracked vehicles, mobile cranes and heavy sledges is stationed and maintained there.

The population at NM-II varies strongly between nine to eleven persons wintering, and often more than 40 persons present at a time in austral summer. A newly established air-link within the frame of the internationally organised Dronning Maud Land Air Network (DROMLAN) provides a very efficient access from Cape Town (South Africa) to NM-II, Kohnen Station and field sites within DML. In support of this international project a weather forecast centre for aircraft operations has been established at NM-II.

In the long-term the continuation of these activities on the Ekström Ice Shelf requires a new concept for the replacement of the present NM-II. Extensive studies by interferometric satellite imageries and geodetic GPS surface measurements have been performed and evaluated in combination with records of the ice shelf dynamics of the past 25 years. Based on these results the most stable location on the Ekström Ice Shelf could be selected, where low ice flow and horizontal ice deformation rates provide the best available conditions for the construction of the new station.

The new construction concept features above-ground and below-ground facilities combined in one large structure which can be raised hydraulically to compensate snow accumulation. So the lifetime of the station is no longer determined by increasing snow pressure but only by its movement with the flow of the ice shelf. A significant longer service lifetime of 25 to 30 years can

therefore be envisaged for the new Neumayer Station III (NM-III).

The station part containing living and working space will be two storied and placed above ground on a 6 m elevated platform of about 68 by 24 m. An aerodynamically shaped, insulated hull is to protect this platform from wind and excessive cold and to reduce snow accumulation or erosion caused by the building around the base. A 76 m long, 26 m wide and 8.2 m deep trench in the snow under the platform, accessible via a ramp, will serve as garage and cold storage room. A flat, rigid roof in level with the snow surface covers the trench. An intermediate deck, covering almost the whole garage area, is hung underneath the garage roof. Here some technical rooms, a workshop with stores, and the food stores will be placed. The whole structure will be supported by 16 legs or columns founded on foundation pads which rest on the snow floor of the garage. The hydraulic cylinders for the jacking of the complete building are arranged as slightly inclined bipods and make up the lowermost part of the 16 columns.

Due to the current demands of science and logistics as well as to meet future requirements the new station will get more protected and more heated space than NM-II. A sophisticated energy management and the inclusion of wind power will contribute to fuel efficiency and minimization of unwanted exhaust gas emissions. In spite of above-ground construction the design of the building and the energy management lead to a lower specific (related to heated area) energy consumption than at NM-II.

With increased awareness of an endangered environment and the Madrid Protocol on Environmental Protection in force the new station will set an example for environmentally sound erection and operation. Harmful exhaust gas emissions will be reduced to a state-of-the-art minimum, if not totally avoided, and wastewater will be treated and partly re-used. No parts of the building will be left in the snow when eventually this station will have to be dismantled and removed from Antarctica.

A Comprehensive Environmental Evaluation (CEE) of the project has been presented to the international Antarctic community and to the public, and after examination a permit has been issued by the German Federal Environmental Agency.

NM-II is one of currently 64 stations, maintained by 27 countries in the Antarctic Treaty area. 48 of them are permanently occupied. Several countries, including Germany, UK, United States, and France/Italy have recently completed or are busy building next generation stations. These will offer more comfortable conditions for living and science and follow up new concepts to extend the service lifetime. To beat the encroaching conditions for constructions on ice, these concepts consider a hydraulic lift of the entire station, keeping it on or above the snow surface as a standard feature in polar architecture of the future.

**Zusammenfassung:** Mit der Gründung des Alfred-Wegener-Instituts für Polarforschung (AWI) im Jahre 1980 – später Alfred-Wegener-Institut für Polar- und Meeresforschung – erhielt die Polarforschung in der Bundesrepublik Deutschland eine zentrale Institution für die Koordination und Ausführung langfristiger und großer wissenschaftlicher Vorhaben in den polaren Regionen. Nachdem die ganzjährig besetzte Forschungsstation Georg-von-Neumayer-Station (GvN) auf dem Ekström-Eisschelf errichtet und in Betrieb angenommen werden konnte, erlangte Deutschland den Konsultativstatus im antarktischen Vertragssystem. Die Bauweise der Station folgte der damals auch von anderen nationalen Antarktisprogrammen angewandten, so genannten „Röhrenkonzeption“, welche den Bau einer langjährig betriebsbereiten Forschungsstation auf dem Eis ermöglichte. Hierbei sind die Stationseinrichtungen in entsprechend dimensionierten Röhren aus Stahl untergebracht. Die gesamte Anlage „versinkt“ jedoch über die Jahre immer tiefer im akkumulierten Schnee. Die Lebenszeit solcher Bauten ist deswegen begrenzt, insbesondere wenn sie dazu noch auf einem driftenden Eisschelf errichtet wurden. Diese Umstände führten dazu, dass die erste Station – die GvN – bereits nach elf Jahren Betrieb in der Saison 1991/1992 durch die derzeitige Neumayer-Station (NM-II) ersetzt werden musste. Mittlerweile nähert sich auch die Betriebszeit der NM-II dem Ende, und sie soll während der Sommermonate 2007/2008 und 2008/2009 durch eine neue Station – die Neumayer-Station III (NM-III) mit innovativem Konzept in der unmittelbaren

<sup>1</sup> Stiftung Alfred-Wegener-Institut für Polar- und Meeresforschung (AWI) in der Helmholtz-Gemeinschaft, Postfach 120161, 27515 Bremerhaven, Germany

Nachbarschaft der Vorgängerstationen ersetzt werden.

Die Forschungsschwerpunkte an der jetzigen Station NM-II liegen im Langzeitbetrieb der Observatorien für Meteorologie, Geophysik und Luftchemie. Seit März 1981 wurden in den drei Observatorien kontinuierliche wissenschaftliche Beobachtungen durchgeführt. Zum geophysikalischen Observatorium gehören zwei Außenstationen südwestlich und südöstlich von NM-II. In 2003 wurde eine weitere Messstation mit einem System von Infrarassensoren (I27DE) eingerichtet. Diese Messstation ist Teil eines globalen Netzwerkes, welches die Organisation zur Überwachung des Kernwaffen-Teststopp-Abkommens in Wien koordiniert. Zum Betrieb des I27DE Infrarasschall Arrays an NM-II hat sich die Bundesrepublik Deutschland im Rahmen des Teststopp-Abkommens (CTBT, Comprehensive-Nuclear-Test-Ban-Treaty) verpflichtet.

In der Saison 2005/2006 wurde als weitere wissenschaftliche Außenstation das hydroakustische Observatorium (PALAOA, Perennial Acoustic Observatory in the Antarctic Ocean) in Betrieb genommen, welches das multidisziplinäre Forschungsprogramm an der Station um ein weiteres Segment bereichert. Die Messstation befindet sich nördlich der Station nahe der Schelfeiskante, wo das natürliche Geräuschspektrum des Ozeans kontinuierlich mit vier Hydrophonen breitbandig aufgezeichnet und das Verhalten von Meeresäußern, die sich mittels Schall verständigen, untersucht wird.

Die Langzeitbeobachtungen an den Observatorien sind in internationale Netzwerke eingebunden, womit wichtige wissenschaftliche Beiträge geleistet und internationale, im Falle des I27DE Infrarasschall Array sogar politische, Verpflichtungen erfüllt werden. In den vergangenen 25 Jahren wurden wertvolle und zum Teil einzigartige Zeitserien aufgezeichnet, deren hohe Qualität international absolut anerkannt ist. Es besteht daher die wissenschaftliche Notwendigkeit, die Observatorien mit ihren Außenstellen auch in Zukunft weiter zu betreiben sowie durch entsprechende technische Verbesserungen weiterhin Daten in hoher Qualität in die internationalen Netzwerke einzuspeisen.

Die Fortsetzung der Messprogramme am gleichen Standort, d.h. auf dem Ekström-Eisschelf, ist von großer wissenschaftlicher Bedeutung und begründet so schon allein das Neubau-Projekt. Zum anderen sind es die logistischen Aufgaben zur Durchführung von Landexpeditionen und zur Unterstützung von Flugzeugeinsätzen im Dronning Maud Land (DML) während der kurzen Sommersaison. Während der letzten Jahre hat sich NM-II zu einem bedeutenden logistischen Zentrum entwickelt, welches nicht nur für die deutschen Forschungsaktivitäten sondern auch zur Unterstützung und Kooperation mit anderen nationalen Programmen zur Verfügung steht. An der Station gibt es eine Schneepiste, auf der kleinere Flugzeuge starten und landen können.

Auf Grund der vielseitigen wissenschaftlichen und logistischen Aufgaben variiert die Zahl der auf der Station tätigen Wissenschaftler und Techniker sehr stark. Während im Winter nur eine kleine Gruppe mit neun Personen dort arbeitet, halten sich in den Sommermonaten zeitweilig 40 bis 60 Personen an der Station auf. Neuerdings gibt es eine Flugverbindung von Kapstadt (Südafrika) zu den Stationen im DML, die im Rahmen eines internationalen Projektes (Dronning Maud Land Air Network, DROMLAN) mit Beteiligung von elf Ländern organisiert wird. DROMLAN bietet einen sehr raschen Zugang zu den deutschen Stationen NM-II und Kohlen und ermöglicht ebenso den Transport von Feldgruppen zu ihren Einsatzgebieten.

Die langfristige Fortsetzung der aufgezeigten wissenschaftlichen und logistischen Aktivitäten erfordert ein neues, langlebiges Konzept für den Bau einer neuen Station. Für die Auswahl eines geeigneten Bauplatzes wurden detaillierte Untersuchungen zur Eisbewegungen mit Hilfe der Satelliten-Interferometrie und GPS-Vermessungen durchgeführt. Mit diesen aktuellen Messungen und unter Verwendung der seit 25 Jahren erhobenen Beobachtungsdaten konnte ein geeigneter Standort für die neue Station NM-III auf dem Ekström Schelfeis bestimmt werden.

Das Baukonzept beinhaltet ein kombiniertes Gebäude, welches sich auf einer Plattform oberhalb der Schneeoberfläche befindet und mit einer darunter in den Schnee gebauten Garage verbunden ist. Das gesamte Bauwerk soll hydraulisch angehoben werden, um den jährlichen Schneezuwachs zu kompensieren. So wird die Lebenszeit der Station nicht mehr unmittelbar von der zunehmenden Schneelast abhängen, sondern lediglich von der wesentlich langsameren Fließbewegung des Eisschelfs bestimmt. Eine Betriebszeit von 25 bis 30 Jahren wird daher für NM-III als realistisch angenommen.

Die Station mit ihren Arbeits-, Wohn- und Aufenthaltsräumen wird aus zwei Stockwerken bestehen, die auf einer Plattform von 68 m Länge und 24 m Breite mit 6 m lichter Höhe montiert werden. Eine Hülle wird diesen Teil des Gebäudes vor Windeinflüssen schützen und, bedingt durch die aerodynamische Form, bauwerksbedingten Schneezuwachs oder Erosion in der Umgebung minimieren. In der 26 m breiten, 76 m langen und 8,2 m tiefen Grube im Schnee unter der Plattform wird eine Garage eingerichtet, unter deren Dach in einem Zwischendeck Raum für technische Einrichtungen, die Vorratskühlräume, eine Werkstatt und Lagerräume vorhanden sein wird. Das gesamte Bauwerk wird von 16 Stützen getragen, die ihre Lasten über flache Fundamente auf den Schneeboden der Garage abtragen. Die hydraulischen Zylinder sind als leicht geneigte Bipoden angeordnet und bilden den untersten Teil der Stützen in der Garage.

Aufgrund des gewachsenen Bedarfs für Forschung und Logistik wird NM-III mehr geschützten und beheizten Raum bieten als NM-II. Ein intelligentes

Energie-Management-System unter Einbeziehungen von Windenergie wird dazu beitragen, den Verbrauch an Dieselmotorkraftstoff zu minimieren. Die Abgasreinigung wird modernen Standards entsprechen. Die Bauausführung des gesamten Komplexes und das Energie-Management werden einen niedrigeren spezifischen Energieverbrauch, bezogen auf die beheizte Fläche, ergeben als für die derzeitige Station NM-II.

Im Rahmen des Antarktisvertrages gelten seit dem Inkrafttreten des Madrider Protokolls zum Umweltschutz in der Antarktis im Januar 1998 allgemein verbindliche Regelungen zum Bau und zum Betrieb von Forschungsstationen. Die Konzeption für NM-III folgt diesen Vorgaben und soll ein Beispiel für umweltgerechtes Bauen und umweltgerechten Forschungsbetrieb in der Antarktis werden. Schädliche Abgasemissionen werden mit Hilfe neuester Technik auf ein Minimum reduziert, wenn nicht ganz vermieden. Die Abwässer werden gereinigt und zum Teil wieder verwendet. Bauteile werden nicht im Schnee zurückgelassen, wenn diese Station am Ende ihrer Betriebszeit rückgebaut und das gesamte Material aus der Antarktis abtransportiert werden muss.

Eine Umweltverträglichkeitsstudie (UVS) wurde für dieses Vorhaben erstellt und der Gemeinschaft der Antarktisvertragsstaaten sowie der Öffentlichkeit vorgestellt. Im Rahmen der Umweltverträglichkeitsprüfung (UVP) wurde vom Umweltbundesamt eine Genehmigung zum Bau der Station erteilt.

In den letzten Jahren haben mehrere Länder darunter Deutschland, Großbritannien, die Vereinigten Staaten sowie Frankreich gemeinsam mit Italien, neue Konzepte beim Bau ihrer Forschungsstationen umgesetzt bzw. sind dabei diese zu realisieren. Die neuen Stationen der nächsten Generation werden komfortablere Lebens- und Arbeitsbedingungen bieten und sollen über längere Zeit betriebsfähig sein. Die Beeinträchtigung durch wachsenden Schnee- und Eisoberflächen mit Hilfe hydraulischer Hebevorrichtungen zu kompensieren, ohne dabei Bauteile immer tiefer im Schneegrund zu hinterlassen, ist ein wesentliches Merkmal der neuen Baukonzepte und somit der Polar-Architektur der Zukunft.

## INTRODUCTION

Germany is one of the Consultative Parties of the Antarctic Treaty since 1981 and maintains a long-term commitment to scientific research in Antarctica. The Alfred Wegener Institute for Polar and Marine Research (AWI) as the national co-ordinator enables Germany to fulfil this role by its research, long-term monitoring and survey activities. It provides the main mobile and stationary infrastructure for Antarctic research, and thus maintains the permanent German presence in Antarctica (Fig. 1). The new institute was named after one of the really prominent German polar researchers, who developed the first in-depth ideas about continental drift. Wegener died in 1930 on his way back from Station Eismitte on the inland ice of Greenland (REINKE-KUNZE 1994).

AWI closely cooperates with national Antarctic programs of the Consultative Parties and holds membership to the related international organizations within the Antarctic Treaty System. In addition to AWI, the Federal Institute for Geosciences and Natural Resources (BGR), the German Aerospace Centre (DLR) and the Federal Agency for Cartography and Geodesy (BKG) perform long-term research activities in Antarctica (DFG 2005).

Antarctic Research in Germany has a long but varied tradition. The historical record reminds of famous names like Georg Forster, who participated in the expedition of James Cook on board the ships "Resolution" and "Adventure" in 1773, but also Eduard Dallmann, Erich von Drygalski, Wilhelm Filchner, Alfred Ritscher as expedition leaders and scientists (Krause 1992, Krause 1993, Barr et al. 2004, Krause et al. 2006). The modern international Antarctic research commenced with the International Geophysical Year (IGY) 1957-1958. After IGY both German governments initiated first steps towards Antarctica (Fleischmann 2005). Since 1959 guest scientists from East Germany had stayed for wintering

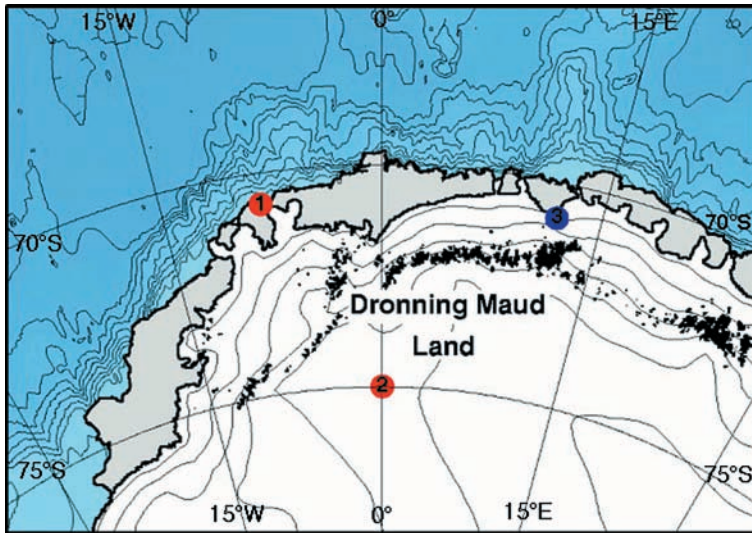

**Fig. 1:** German research facilities in Antarctica, Atlantic sector: Currently operated in red: (1) the permanently occupied station Neumayer II on the Ekström Ice Shelf at  $70^{\circ}38,00'S$ ,  $008^{\circ}15,80'W$  and (2) the summer only Kohnen Station at the inland ice plateau at  $75^{\circ}00'S$ ,  $000^{\circ}04'E$ . In blue (3): the position of the former Georg Forster Station in the Schirmacher Oasis at  $70^{\circ}46'S$ ,  $011^{\circ}41'E$ . Not shown are the Dallmann Laboratory as annex to the Argentinean station Jubany at King George Island ( $62^{\circ}14,27'S$ ,  $058^{\circ}39,87'W$ ), and the German Antarctic receiving Station (GARS) as annex to the Chilean station Bernardo O'Higgins ( $63^{\circ}19,25'S$ ,  $057^{\circ}54,02'W$ ). Contour lines 500 m.

**Abb. 1:** Die deutschen Forschungsstationen in der Antarktis, atlantischer Sektor. In Rot: (1) Die ständig besetzte Neumayer-Station II auf dem Ekström-Schelfeis bei  $70^{\circ}38,00'S$ ,  $008^{\circ}15,80'W$ , und (2) die Sommerstation Kohnen auf dem antarktischen Inlandeisplateau bei  $75^{\circ}00'S$ ,  $000^{\circ}04'E$ . In Blau (3): Die Position der ehemaligen Georg-Forster-Station in der Schirmacher Oase bei  $70^{\circ}46'S$ ,  $011^{\circ}41'E$ . Nicht gezeigt sind das Dallmann-Labor als Annex zur argentinischen Station Jubany auf King George Island bei  $62^{\circ}14,27'S$ ,  $058^{\circ}39,87'W$ , und die deutsche Satellitenempfangsstation in der Antarktis (GARS) als Annex zur chilenischen Station Bernardo O'Higgins bei ( $63^{\circ}19,25'S$ ,  $057^{\circ}54,02'W$ ). Abstand der Höhenlinien 500 m.

and worked in the field at several Russian Antarctic stations. Likewise scientists from West Germany joined US expeditions.

In 1974 the Antarctic Treaty was signed by East Germany, which reached Consultative Status in 1987. The first permanently operated research base – later named Georg Forster Station – was established in 1976 in the Schirmacher Oasis at  $70^{\circ}46'S$ ,  $011^{\circ}41'E$  (GERNANDT 1984, LANGE 1996, FLEISCHMANN 2005). At that time the concept using pre-fabricated container modules for laboratories, power plant and accommodation was pioneering. Altogether eight container modules were carried on sledges from the unloading site at the ice edge of the Lazarev Ice Shelf over a distance of 120 km into the Schirmacher Oasis and assembled to a research base within only six weeks (Fig. 2). Since then the station was permanently used and operated as an annex to the Russian station Novolazarevskaya until 1987, and then as a German Antarctic station named after Georg Forster until 1993. Long-term studies of magnetospheric-ionospheric processes, geophysical investigations, biological studies and sea-ice observations using satellite imaging were performed (BORMANN & FRITZSCHE 1995). In 1985 this station became known to the international scientific community when the vertical extension of the strong ozone depletion (ozone hole) in the southern polar stratosphere was firstly recorded by regular balloon-borne ozone observations. These ozone measurements were performed at Georg Forster Station until 1992 and continued at Neumayer Station afterwards.

The Antarctic Research Program of the Federal Republic of Germany was established in 1978, and the Antarctic Treaty was signed in 1979. The Federal Institute for Geosciences and Natural Resources (BGR) performed the first terrestrial expedition (GANOVEX I) into North Victoria Land in 1979/80. Germany reached Consultative Status on 3 March 1981 after the foundation of the Alfred Wegener Institute for Polar Research (AWI) in 1980 and commissioning of the permanently occupied research station Georg von Neumayer (GvN) on the Ekström Ice Shelf (Fig. 3) (ENSS 1981, ENSS 1981a). The station was named after Georg von Neumayer (1826-1909), an internationally recognised scientific organiser, who promoted the First International Polar Year (1882/83) and successfully initiated for the first time coordinated meteorological and

geomagnetic observations. He strongly supported planning and performance of the first German Antarctic expedition under the leadership of Erich von Drygalski, which departed in coordination with the expeditions of other countries in 1901 (KRAUSE 1996, KRAUSE 2001).



**Fig. 2:** Georg Forster Station in the Schirmacher Oasis at  $70^{\circ}46'S$ ,  $011^{\circ}41'E$ , originally established as an annex to the Soviet station Novolazarevskaya, which was commissioned on 20 April 1976. At that time the construction concept was pioneering. Prefabricated container modules for laboratories, small power plant and accommodation were carried on sledges from the unloading site at the ice edge of the Lazarev Ice Shelf over a distance of 120 km into the Oasis. There the base was assembled on rocks within six weeks. Figure shows the base after the first wintering. In forefront the main building consists of six modules. The power plant on the right side is separated from the compound because of safety reasons. One module close to the antenna mast accommodated the radio transmitting system for ionospheric studies. The station was used until 1993 and then dismantled in the frame of a German-Russian project, which was completed in 1996.

**Abb. 2:** Georg-Forster-Station in der Schirmacher Oase auf  $70^{\circ}46'S$ ,  $011^{\circ}41'E$  war die erste deutsche Überwinterungsstation in der Antarktis; sie wurde ursprünglich als Annexbau (Basislaboratorium) zur sowjetischen Station Novolazarevskaya errichtet, welcher am 20. April 1976 in Betrieb genommen wurde. Zu diesem Zeitpunkt war die Bauweise bahnbrechend. Vorgefertigte Containermodule, die als Laboratorien, Unterkunft und Kraftstation dienen sollten, wurden von der Entladestelle an der Eiskante des Lazarev-Schelfeises über eine Strecke von 120 km auf Schlitten in die Oase gebracht. Hier wurde die Station innerhalb von sechs Wochen auf Fels errichtet. Das Bild zeigt die Station nach der ersten Überwinterung. Im Vordergrund steht das Hauptgebäude aus sechs Modulen. Die Kraftstation (rechts) ist aus Sicherheitsgründen vom Stationsgebäude getrennt. Ein Modul nahe am Antennenmast enthält das Übertragungssystem für ionosphärische Untersuchungen. Die Station wurde bis 1993 betrieben und anschließend im Rahmen eines deutsch-russischen Projekts bis 1996 abgebaut.



**Fig. 3:** Georg von Neumayer (GvN) research station built on the moving Ekström Ice Shelf at initial position  $70^{\circ}37'S$ ,  $08^{\circ}22'W$  and commissioned on 3 March 1981. The photo shows the station just after completion of construction works. The concept is an underground station made of two parallel steel tubes, which accommodate containerised modules for a wintering team of four scientists, four technicians and one physician. The increasing loads of accumulating snow led to unavoidable destructions. The station lasted for eleven years and was replaced by the present Neumayer Station II (NM-II) during austral summer season 1991/1992.

**Abb. 3:** Die Forschungsstation Georg-von-Neumayer (GvN) auf dem driftenden Ekström-Schelfeis (anfängliche Position am 3. März 1981 bei  $70^{\circ}37'S$ ,  $008^{\circ}22'W$ ). Das Bild zeigt die Station unmittelbar nach Beendigung der Aufbauarbeiten. Das Konzept ist eine unterirdische Station bestehend aus zwei parallelen Stahlröhren, in denen Containermodule untergebracht sind. Das Überwinterungsteam besteht aus vier Wissenschaftlern, vier Technikern und einem Arzt. Der wachsende Schneeeauftrag führt unvermeidbar zur Zerstörung der Station. Diese Station hatte eine Lebensdauer von elf Jahren und wurde während des Südsommers 1991/1992 durch die jetzige Neumayer-Station II (NM-II) ersetzt.



**Fig. 4:** The present Neumayer Station II (NM-II) on the Ekström Ice Shelf (initial position  $70^{\circ}39'S$ ,  $008^{\circ}15'W$ ) was commissioned in 1992. The station is meanwhile covered by c. 9 m of accumulated snow, and will bear the increasing loads until 2009 at the longest. The photo shows the two stairway entries (foreground right), antennas and air ducts, the ramp to the garage section (left upper corner) as well as the wind power plant (background), which have to be extended periodically according to snow accumulation to keep access to the tubes below the snow surface. Presently the stairway towers have 96 steps.

**Abb. 4:** Die jetzige Neumayer-Station II (NM-II) auf dem Ekström-Schelfeis (Anfangsposition  $70^{\circ}39'S$ ,  $008^{\circ}15'W$ ) ging 1992 in Betrieb. Inzwischen befindet sich die Station durch den Schneeeauftrag ca. 9 m tief unter der Schneeoberfläche. Dieser zunehmenden Auflast können die Röhren höchstens bis 2009 widerstehen. Das Bild zeigt die beiden Treppenhäuser (Vordergrund rechts), Antennen, Auspuff- und Lüftungsrohre, die Rampe zur Garage (Hintergrund links oben) sowie den Windgenerator (Hintergrund Mitte), die alle regelmäßig verlängert werden müssen, um die Funktionen aufrecht zu erhalten. Die Treppenhäuser führen inzwischen über 96 Stufen hinunter in die Station.

Further terrestrial research facilities within the German Antarctic program were established in cooperation with other national programs over the years. The Dallmann Laboratory is operated as a part of the Argentinean station Jubany on King George Island at  $62^{\circ}14'S$ ,  $058^{\circ}14'W$ . It was established in 1994 as an international laboratory funded by the Instituto Antartico Argentino (IAA), The Netherlands Council of Earth and Life Sciences (NWO) and AWI. Since then about 25 to 35 scientists have been working at the laboratory during summer seasons every year.

The German Antarctic Receiving Station (GARS) is an annex station to the Chilean station General Bernardo O'Higgins ( $63^{\circ}19'S$ ,  $057^{\circ}54'W$ ). Since October 1991 GARS has cooperatively been run and managed by the German Aerospace Centre (DLR) and the Instituto Antartico Chileno (INACH). GARS is part of the international ground segment for remote sensing in the southern hemisphere. Up to 15 scientists can be accommodated in a campaign. The station is only occupied about 120 days per year.

The present Neumayer Station II (NM-II) on the Ekström Ice Shelf ( $70^{\circ}39'S$ ,  $08^{\circ}15'W$ , 40 m ASL) was commissioned in 1992 (Figs. 4, 5), and it replaced the first research base GvN. Like its predecessor NM-II is built in the snow below the surface (Enss 1992). Such constructions are increasingly covered by accumulating snow and last only a few years until the snow pressure destroys them. The first station GvN was in service for eleven years until 1992. The improved construction of NM-II was designed for a longer time of about 15 years.

In January 2001 the latest stationary facility – Kohnen Station – was commissioned about 500 km south of NM-II at  $75^{\circ}00'S$ ,  $00^{\circ}04'E$  on the Antarctic inland ice plateau at an elevation of 2892 m. This station is operated during austral summer only and has to be supplied by surface traverses and aircraft from NM-II.

Several countries, including Germany, UK, United States, and France/Italy have recently completed or are busy building next generation stations. These will offer more comfortable conditions for living and science, but they have also to meet tighter environmental regulations. At the South Pole the collapsing buildings of the Amundsen-Scott Station (US) have been replaced by a new complex on platforms. At Dome C the Concordia Station has been built jointly by France and Italy. The station consists of two octagonal buildings where a crew of 16 stayed in 2005 for the first winter. Both buildings of Concordia Station rest on legs, which can hydraulically lift the entire station. The UK and Germany are facing even tougher challenges than Concordia and the US South Pole station on the almost immovable inland ice with little snow accumulation. They have to build "mobile homes" on flowing and deforming ice in areas with considerable accumulation rates: Halley VI on the Brunt Ice Shelf and the new Neumayer Station III (NM-III) on the Ekström Ice Shelf. Both stations will be built on carefully selected sites to ensure the longest possible service life. Both will be constructed on jackable platforms. To beat the encroaching ice all concepts follow the hydraulic lift concept of keeping the entire station on or above the snow surface as a standard feature in polar architecture of the future (SCHIERMEIER 2004).

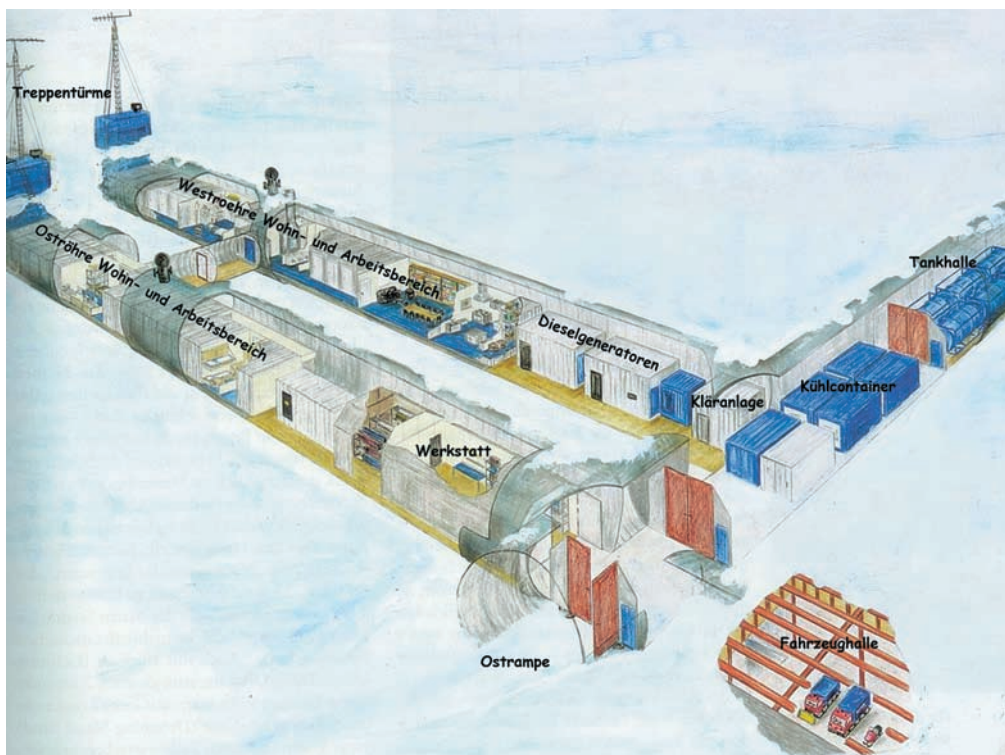

**Fig. 5:** Scheme of Neumayer Station II (NM-II) below the snow surface. The central building is a steel tube system consisting of two main tubes (eastern tube 82 m, western tube 92 m in length), a 92 m long cross tube with stores and fuel tanks and a garage in a snow trench.

**Abb. 5:** Schematische Darstellung der Neumayer-Station II (NM-II) unter der Schneeoberfläche. Das zentrale Bauwerk ist ein System von Stahlröhren, welches aus zwei parallel ausgerichteten Haupttröhren (Oströhre mit 82 m Länge, Westrohre mit 92 m Länge), einer 92 m langen Querröhre mit Lagern und Treibstofftanks und einer Garage in einem Schneegraben besteht.

## FACILITIES AND ACTIVITIES AT NEUMAYER II

Neumayer Station II (NM-II) is one out of currently 37 permanently occupied stations in the Antarctic Treaty area (COMNAP 2006). The station is built in the snow below the surface (Fig. 5). A steel tube system, consisting of two main tubes of 82 and 92 m lengths and a 92 m long cross tube, house the station proper, while tracked vehicles, cranes and skidoos are parked in a garage in a snow trench. The tube diameter is 8 m, and the gross area inside the tubes is 2128 m<sup>2</sup>. The main tubes accommodate 56 containerised modules with living and working spaces and all technical services of the base. Fuel tank containers and food stores are placed in the cross tube. Power is provided by two diesel generators of 100 kW each, one emergency generator of 50 kW, and one wind generator of 20 kW. All required heating is taken from the diesel engines through heat exchangers. A summary of basic data of NM-II is compiled in Table 1 (for further details see KOHLBERG et al. 2007).

Scientific and technical equipment is at a high level standard. The local IT network serves laboratories and the data acquisition systems of the observatories and measurement sites. Communication, data transfer and Internet connection has been established via a permanent satellite link (128 kbit s<sup>-1</sup>). Further communication facilities are Iridium, common INMARSAT links as well as VHF and HF radio.

Outside structures are placed jackable or extendable on steel platforms: a balloon-launching shed, a container housing the I27DE central array control system, a clean air chemistry laboratory (Figs. 6 A,B,C), a radom with dish antenna (Fig. 11), and the wind generator.

The wintering staff consists of the station leader, usually a physician, four scientists, three technicians and the cook.

During austral summer about 30-60 scientists and technicians are temporarily accommodated in outdoor modules to perform scientific fieldwork, aircraft missions and surface traverses with vehicles as well as maintenance works at the station buildings and at the observatories.

Again the limited lifetime and the need to keep all station infrastructure at a high standard with respect to the increasing scientific and logistic demands make an advanced replacement by a new station necessary by 2009 at the latest.

### *Scientific observatories at Neumayer Station II*

Meteorological observations have continuously been carried out at GvN since March 1981. In March 1992 the program was extended and transferred to NM-II (KÖNIG-LANGLO & LOOSE 2007). The meteorological observatory (Fig. 6A) regularly performs 3-hourly synoptic observations, daily upper air soundings including weekly ozone profile measurements, and substantial surface radiation measurements as routine observations. The balloon-borne ozone measurements began in 1992 and continued the ozone observations performed at the nearby Georg Forster Station from 1985 until 1992. These data subsequently gained at both stations over a period of 22 years represent the longest and thus unique record of the stratospheric ozone depletion in Antarctica (KÖNIG-LANGLO et al. 2006).

The meteorological observatory is an integral part of many international networks, mostly associated with the World Meteorological Organization (WMO). The data help to close significant gaps in the global weather and climate observing networks. NM-II takes part in the Global Telecommunication Network (GTS), the Global Climate Observing System (GCOS), the Global Atmospheric Watch (GAW), the Network for the Detection of Stratospheric Change (NDSC), and the

Item	Description / data
Geographic position	70° 38' S, 008° 16' West (2004), Ekström Ice Shelf, Atka Bay
Distance to SANAE IV Station	225 km (aircraft and vehicles only, summer season only)
Distance to Halley Station	800 km (aircraft and ship only, summer season only)
Distance to Novolazarevskaya Station	740 km (aircraft and ship only, summer season only)
Distance to Kohnen Station	553 km (aircraft and vehicles only, summer season only)
Distance to Cape Town	2362 nautical miles = 4375 km (2 x 9 to 11 days by ship, summer season only)
Thickness of ice shelf at building site	about 240 m
Ice shelf flow velocity	160 m per year in northerly direction
Distance to ship's landing place	15 km ("Landing Place North" at the ice shelf edge)
Air strip on snow (only during summer season)	1000 m long, for small STOL aircraft on skids, Do 228 (Dornier DO228, Twin Otter, Basler BT-67)
Snow accumulation rate	c. 80 cm per year
Horizontal snow deformation rates	2 mm per m per year (strain and compression)
Design wind velocity	61 m s <sup>-1</sup> (220 km/h = very severe storm)
Design temperatures	Max. +5 °C, min. -50 °C
Percent of days with drifting snow	60 %
Planned service life time of station	15 years
Jacking equipment of garage roof	21 spindles, 0.5 m stroke and 15 ton capacity each
Station building total size	231 m north – south, 116 m east – west
Sizes of main building sections	Steel tubes total 273 m long of 8.32 m diameter plus 16 m of 4.16 m diameter; Garage 46.4 m long and 16.7 m wide, 4.75 m high; snow tunnel tubes to garage 60.8 m long; 2 stair towers, each 7.2 m by 2.8 m, meanwhile 20 m high; 2 covered vehicle ramps with 17° inclination.
Total weight of the building	c. 1600 tons
Basic construction materials	Steel, light metal, timber, plastics; no CFCs containing insulation or auxiliary materials.
Heated areas winter section	914 m <sup>2</sup> (thereof 119 m <sup>2</sup> labs)
Heated areas summer section	not available in station
Cold rooms	26 m <sup>2</sup> deep freeze room (-18 °C), (2 reefers) 26 m <sup>2</sup> cold room (+5 °C); coolant R134A / R404A
Cold usable areas without garage and snow tunnel	c. 620 m <sup>2</sup> (tubes, stairs, cold storage)
Usable area in garage (cold)	775 m <sup>2</sup>
Total protected areas	2929 m <sup>2</sup> (including snow tunnel to garage)
Laboratories / observatories	Meteorology (with balloon filling platform), geophysics, air chemistry, photo and wet lab, multipurpose lab, electronics workshop, lab stores. Outstations: air chemistry, seismics, magnetics, meteorology measuring field, infrasound, as well as measuring more distant recording points.
Station hospital	Medical care up to smaller operations possible
Wintering staff	Max. 11 persons; during exchange in summer season max. 22 persons
Summer season personnel	Accommodation only in containers/huts/tents next to station and without sanitary facilities.
Power generation	Diesel generators 2 x 100 kW + 1 x 75 kW, average demand 80 kW, 400/230V, 3 phase 50 Hz; 20 kW wind generator
Renewable energy	Wind generator 20 kW
Uninterrupted power supply (UPS)	Sealed batteries, 2 x 5 kVA for 20 minutes
Fuel, storage / consumption	Polar Diesel; 6 tanks 22000 l in station tube; c. 191300 l annual consumption (without vehicles, including 20 kW wind generator usage)
Electrical cables	All cables shielded, silicon jackets halogen-free, flame retardant
Daily fresh water demand	115 l per person
Water generation	10 kW snow melter, use of excess heat only; 4 m <sup>3</sup> / 4 m <sup>3</sup> melting tank / storage capacity
Hot water generation	Excess heat driven boiler (winter and summer)
Heating / ventilation	All heating by usage of excess heat of diesel engines; air humidification c. 6 kW, forced ventilation in garage.
Fire protection	Halon (halogenated hydrocarbon), carbon dioxide
Sewage treatment	Biological cleaning and disinfection of combined (grey/black) waste-waters and discharge to snow pit; direct collection facilities for dangerous liquids from laboratories
Garbage treatment	Separate collection, compaction, complete removal, no combustion at the station
Construction time / team	66 days (6 January to 11 March 1992) / 47 men

**Tab. 1:** Neumayer Station II (NM-II) Basic technical data (Enss pers. com. 2006).

**Tab. 1:** Technische Daten zur Neumayer-Station II (NM-II) (Enss pers. Mitteil. 2006).

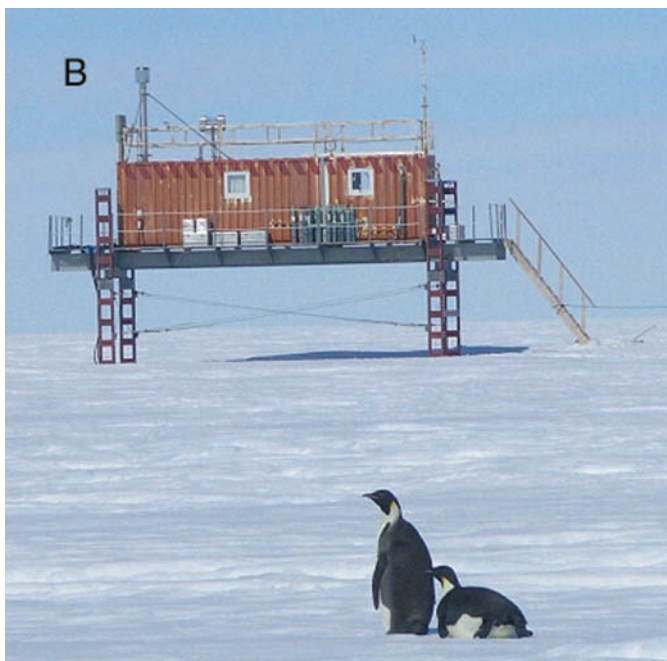

**Fig. 6:** Outside observatory structures at Neumayer Station II (NM-II) for meteorological, air chemical and geophysical investigations, measurements and data recording.

A = Balloon-launching container of the meteorological observatory for daily upper air soundings and weekly ozone concentration profile measurements.

B = Air chemistry observatory installed approximately 1.5 km south of NM-II.

II. The long-term program is focussed on sampling and *in-situ* measurements of tropospheric trace gases of climate relevance.

C = Geophysical observatory; the container houses the Infrasound Station I27DE central control unit and the data transmission units of seismic and geomagnetic data of station VNA1 (for location see Fig. 13). The instruments of this station are in an ice cavern almost 10 m below the snow surface; entrance to the cavern is seen in the background (left side).

**Abb. 6:** Außen liegende Labor-, Mess- und Datenerfassungseinrichtungen der meteorologischen, luftchemischen und geophysikalischen Observatorien and der Neumayer-Station II (NM-II).

A = Ballonfüllhalle des meteorologischen Observatoriums für die täglichen Radiosondierungen und die wöchentlichen Messungen der vertikalen Ozonverteilung.

B = Luftchemie-Observatorium 1,5 km südlich von NM-II. Das Langzeitprogramm konzentriert sich auf Probenahmen und *in situ* Messungen klimawirksamer troposphärischer Spurengase.

C = Messcontainer des geophysikalischen Observatoriums mit der zentralen Steuereinheit für das Infraschall-Array I27DE und die Datenübertragung für Seismometer und Magnetometer der Messstelle VNA1 (zur Lokation siehe Fig. 13). Die Messinstrumente zur Seismik und Magnetik befinden sich etwa 10 m tief in einer Eishöhle, deren Zugang im Hintergrund, links der Stützen zu erkennen ist.

Baseline Surface Radiation Network (BSRN). Meanwhile, data over a period of 25 years have been collected and archived in a carefully validated and post processed form. These qualified data records are of high relevance for climate change studies. Additionally, the meteorological observatory evolved more and more into the meteorological forecast centre for the Dronning Maud Land and provides local weather information for airborne, ship and field operations during summer seasons.

The air chemistry observatory (Fig. 6B) is designed for contamination-free measurements (WELLER et al. 2007). It is currently located approximately 1.5 km south of NM-II. The long-term program is focussed on sampling, *in-situ* measurements and optical remote sensing observations to analyse green-house gases, snow samples, stratospheric trace gases and spectral optical properties of atmospheric aerosols. The observatory is in continuous operation since nearly 25 years. It thus provided unique records of atmospheric trace constituents of climatic relevance. The focus of the established observational program is on characterizing the physical properties and chemical composition of the aerosol, as well as on monitoring the changing trace gas composition of the background atmosphere, especially concerning greenhouse gases. The observation program is maintained jointly by AWI and the Institute for Environmental Physics (IUPH) at the University of Heidelberg.

The geophysical observatory (Fig. 6C) has now been in continuous operation for nearly 25 years (ECKSTALLER et al. 2007). The main subjects are currently the continuous recording of the Earth's magnetic field and the regional and global earthquake activities. For monitoring the regional seismicity a local seismographic network is operated. It consists of three measuring sites, the VNA1 at Neumayer Station and two remote stations. These are located on the ice rises Halvfjar Ryggen (VNA2) and Søråsen (VNA3) located approx. 50 km and 85 km away from NM-II in the Southeast and Southwest (see Fig. 13) The seismic signals from these stations are transmitted digitally to the base for recording. At the site of VNA2 a small aperture, short period detection array was deployed in the beginning of 1997. This array proved to be a powerful tool for the detection of weak local and regional seismicity and has been the first one of this type in Antarctica. The geophysical

observatory at NM-II closes a large gap in the worldwide network of geophysical monitoring stations, which is rather wide-meshed in Antarctica.

During austral summer 2002/2003 the Federal Institute for Geosciences and Natural Resources (BGR) in close cooperation with AWI has commissioned the I27DE Infrasound Array (ECKSTALLER et al. 2007). It measures micro-pressure fluctuations in the atmosphere and is one of the four stations operated in Antarctica. The global infrasound network – the International Monitoring System (IMS) – consists of 60 stations. It was established to detect and to locate worldwide any atmospheric nuclear explosion of 1 kiloton TNT equivalent or more in order to monitor the compliance of the Comprehensive Nuclear Test Ban Treaty (CTBT). The I27DE Infrasound Array consists of nine individual array elements (Fig. 7). They have been distributed on a spiral at regularly increasing radii from the centre point, resulting in a configuration like a “pinwheel” with an aperture of about 2 km. The centre point of the array is about 3 km southwest of the NM-II. A container placed on a steel platform about 800 m south of NM-II (Fig. 6C) houses the central array control system that provides power for the array elements and records the continuously incoming data streams from the array before they are sent via the permanent satellite link to the German NDC (National Data Centre) at BGR and to the IDC (International Data Centre) of the CTBTO (Comprehensive Test Ban Treaty Organization) in Vienna.

During austral summer 2005/2006 the Perennial Acoustic Observatory in the Antarctic ocean (PALAOA) was set up (BOEBEL et al. 2006). PALAOA is located as close as possible to the ice-shelf edge north of NM-II (Fig. 8). It continuously records the underwater sound with four hydrophones installed in the water below the about 100 m thick ice-shelf sheet. Processed data are used to recognize species-specific vocalizations of marine mammals such as whales and seals, to infer the approximate number of animals, to calculate their movements and to examine possible effects of the natural sounds and the sporadic shipping traffic on the acoustic and locomotive behaviour of marine mammals.

The southernmost outside facility of NM-II is the Kohnen Station at the Antarctic inland ice plateau (see Fig. 13), primarily designed and constructed for deep ice core drilling within the frame of the European Project on Ice Coring in Antarctica (EPICA). The construction works were performed during two summer seasons (DRÜCKER et al. 2002), and it was commissioned on 6 January 2001. In the course of three austral summers a 2774 m ice core was drilled with high chronological resolution for studies of decadal to millennial paleoclimate variations. It has been possible to synchronize this ice core with Greenland ice core records, and a one-to-one coupling of climate variability could be shown for the last glacial period (EPICA COMMUNITY MEMBERS, 2006). The prospective tasks of Kohnen Station are (i) the unique deep *in-situ* glaciological laboratory as such the drill hole will further be used, (ii) running automatic measurements for seismology and air chemistry, and (iii) logistic starting point for deep field traverses and aircraft missions over the Antarctic inland ice plateau. So, Kohnen station needs logistic support by the tracked vehicle fleet of NM-II whenever scientific activities are planned (see Fig. 12B). The station is also accessible by aircraft (Fig. 9).

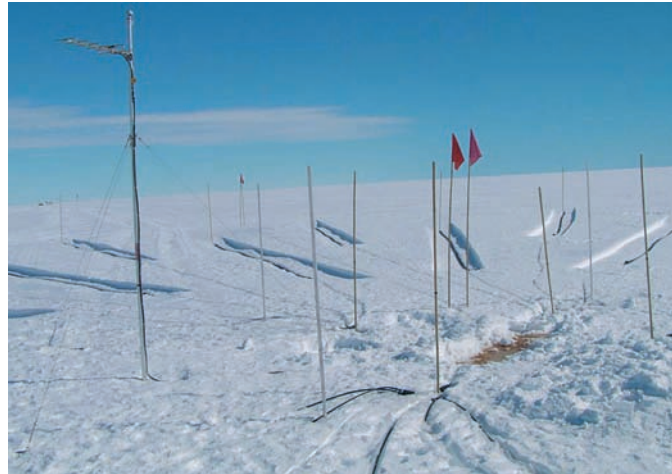

**Fig. 7:** One out of the nine individual array elements of Infrasound Station I27DE; the micro-pressure sensors have to be excavated from the accumulated snow and again placed on the snow surface every year.

**Abb. 7:** Eines der neun individuellen Array-Elemente der Infraschallstation I27DE. In jeder Sommersaison müssen die empfindlichen Drucksensoren aus dem akkumulierten Schnee ausgegraben und auf der Schneeoberfläche neu verlegt und eingerichtet werden.



**Fig. 8:** The hydro-acoustic observatory (PALAOA) is closely located to the ice-shelf edge. The underwater sound is continuously recorded with four hydrophones installed in the water below the 100 m thick ice-shelf sheet.

**Abb. 8:** Das hydro-akustische Observatorium (PALAOA) steht nahe an der Abbruchkante des Schelfeises und registriert kontinuierlich den Unterwasserschall mit vier Hydrophonen die im Wasser unter dem etwa 100 m dicken Schelfeis fixiert sind.

Since 1981 all observatory programs are integrated into quite a number of international networks for scientific and with I27DE Infrasound Array even for political objectives. In the past 25 years very valuable and unique time series have been recorded which are of great importance for climate research and therefore highly recognised by the international community.

#### *Logistic infrastructure at Neumayer Station II*

During austral summer NM-II is accessible by aircraft, which fly personnel and scientific cargo from Cape Town to the station within few days. Two ship calls are scheduled every season in order to transport the major part of supply cargo and materials for maintenance as well as to remove waste and





**Fig. 9:** Kohnen Station is the southernmost outside facility, which has to be supplied via NM-II. Small aircraft such as Basler BT-67 provide access to the station early in the season in order to extend the operational period. The main building of Kohnen Station consists of a 32 x 8 m platform on steel pillars on which eleven prefabricated container modules are mounted. Up to 25 persons can be accommodated.

**Abb. 9:** Die Kohnen-Station ist die südlichste Außenstelle, die über die NM-II versorgt wird. Kleinere Flugzeuge wie die Basler BT-67 ermöglichen bereits früh in der Sommerperiode den Zugang. Das Hauptgebäude besteht aus elf vorgefertigten Container-Einheiten auf einer 32 x 8 m Stahlplattform. Insgesamt können mit Nutzung der Notstation (rote Hütten im Hintergrund) bis zu 25 Personen an der Station arbeiten.

other return cargo. The ships moor to the edge of the Ekström Ice Shelf or early in the season at the rim of fast ice (not yet broken up sea ice) at Atka Bay (Fig. 10). The Atka Bay even serves as the unloading site for the South African National Antarctic Program (SANAP). In austral summer 2003/04 the over-ice route between the Atka Bay and SANAE IV station was traversed for the first time by a South African expedition. Since then supply cargo for this station is unloaded here and is further transported by tracked vehicles to the station over a distance of about 300 km (see Fig. 13). During austral summer at least three or four ship calls give additional flexibility for the coordination of all supply and removal needs for both the AWI and SANAP.

For airborne missions a snow runway is prepared every season, where small ski-equipped aircraft like Dornier 228, Twin Otter or Basler BT-67 can land (Fig. 11). Ground service equipment and refuelling facilities are provided to operate and serve scientific aircraft missions off NM-II and to support aircraft activities of other national operators. During austral summers the research aircraft of AWI are operated from NM II and also from other stations such as Kohnen Station, Halley (BAS) or S17 camp (JARE) close to the Japanese station Syowa. The mobilization and demobilization of AWI research aircraft bound for NM-II is performed via Punta Arenas (Chile), with support provided by the British stations Rothera and Halley.

The vehicle fleet stationed and maintained at NM II is a very important logistic tool (Fig. 12A). It comprises eleven Kässbohrer "Pisten-Bully" tracked vehicles specially adapted to Antarctic conditions. They have a strengthened frame in order to withstand the stress of pulling heavily loaded sledges during supply and research traverses southbound up to the elevated inland ice plateau. They are equipped with GPS navigation, appropriate communication equipment, and can



**Fig. 10:** Supply of Neumayer Station II (NM-II) by ship, unloading of RV "Polarstern" dynamically moored to the edge of the Ekström Ice Shelf near Atka Bay (for location see Fig. 22).

**Abb. 10:** Schiffsversorgung für die Neumayer-Station II. Entladung von RV "Polarstern" an der Abbruchkante des Ekström-Schelfeises nahe der Atka-bucht (zur Orientierung siehe Fig. 22).



**Fig. 11:** Ground service and refuelling facilities at NM-II for smaller aircraft such as Dornier 228, Twin Otter and Basler BT-67. The radom (right) housing the satellite dish-antenna for the permanent satellite communication link (128 kbit s<sup>-1</sup>) is installed on a special support structure, which has to be extended regularly to compensate snow accumulation.

**Abb. 11:** Bei NM-II stehen für die Flugzeuge Dornier 228-101, Twin Otter oder Basler BT-67 Service-Einrichtungen und Tankanlagen zur Verfügung. Im Radom (rechts) ist die Parabolantenne für die Satelliten-Standardleitung (128 kbit s<sup>-1</sup>) montiert; auch dieses Trägergestell muss wegen des Schneeeintrages regelmäßig erhöht bzw. angehoben werden.

operate year-round allowing the servicing of deep field observatory installations. This backbone of deep field logistics is augmented by 30 smaller vehicles (Skidoo), sledges for heavy and light loads, mobile tank containers, mobile accommodation and sundry other equipment necessary to ensure optimal working conditions for scientists as well as their personal safety. If needed the tracked vehicles are regularly transported back to Germany for inspection and maintenance. Additionally two heavy Chieftain crane vehicles are available for construction and jacking up works at the station.

Beside scientific tasks the vehicle fleet is used for transportation of all cargo from the unloading site to the station, for service of outside facilities of the geophysical observatory and – one of the major tasks – for supply of Kohnen Station (Fig. 13) when scientific activities are scheduled there. The route between NM-II and Kohnen is about 750 km. Depending on



**Fig. 12:** The tracked vehicle fleet at NM-II consists of eleven Kässbohrer “Pisten Bully” (PB 260 and PB 300).

A = All vehicles are specially adapted to Antarctic conditions; they are all equipped with GPS navigation, appropriate communication equipment, and have a strengthened frame in order to withstand the stress of pulling heavily loaded sledges.

B = En route supply traverse for Kohlen Station on the inland ice plateau. Depending on weather conditions it takes 9 to 14 days one way. About 100-150 tons of cargo and consumables have to be transported, when the station is to be operated for about 60 to 80 days during summer season. Typically six tracked vehicles, 17 sledges carrying piece goods, living and fuel containers are arranged for such a deep field supply traverse.

**Abb. 12:** Die Kettenfahrzeugflotte an NM-II besteht aus elf Kässbohrer „Pisten Bullys (PB 260 und PB 300).

A = Alle Fahrzeuge sind speziell für die Einsatzbedingungen in der Antarktis modifiziert, sind ausgestattet mit GPS-Navigation, geeigneter Kommunikationstechnik und haben verstärkte Rahmen, um schwer beladene Frachtschlitten auch über weite Strecken über das Eis zu ziehen.

B = Schlittenzug auf Versorgungsfahrt von NM-II zur Kohlen-Station, die über mehr als 750 km je nach Wetterlage ca. 9 bis 14 Tage dauert. Etwa 100-150 t müssen transportiert werden, um den Stationsbetrieb für 60-80 Tage zu gewährleisten. Für eine Versorgungsfahrt werden in der Regel sechs Kettenfahrzeuge mit 17 Schlitten, beladen mit Stückgut, Wohn- und Treibstoff-Containern bereitgestellt.

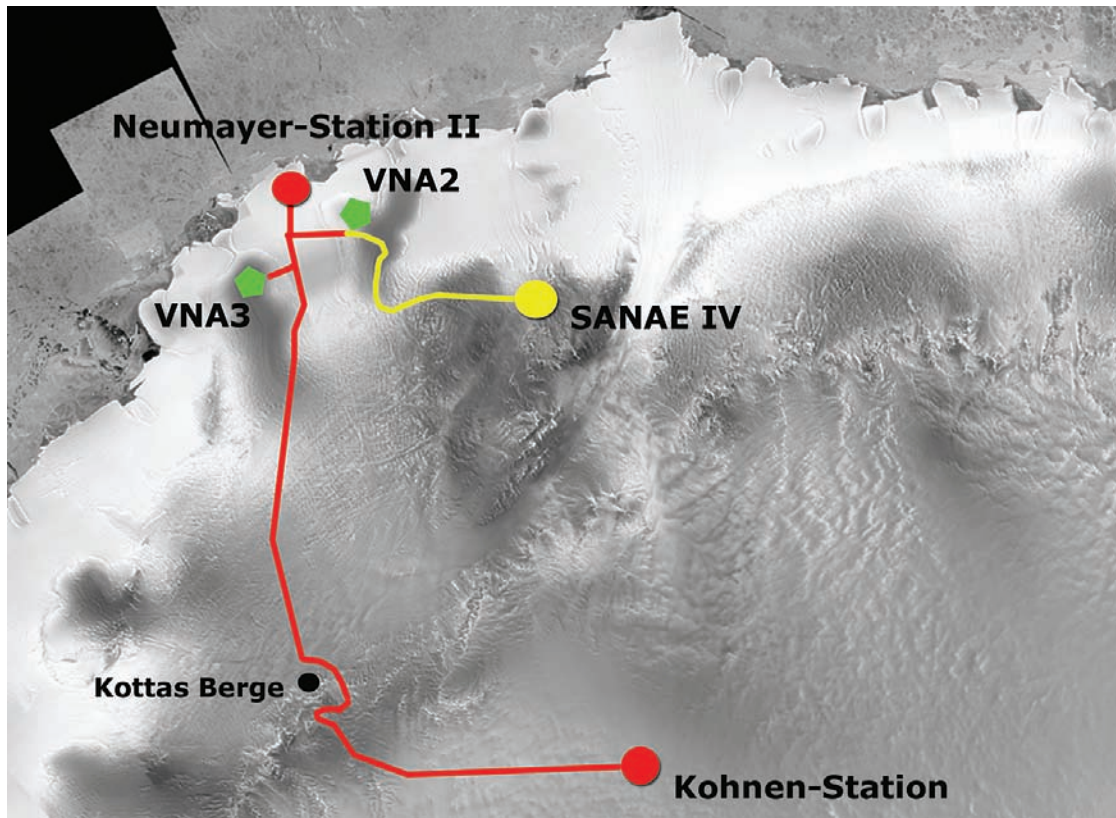

**Fig. 13:** Outside facilities to be serviced by the vehicle fleet of NM-II such as outside installations of the geophysical observatory VNA2 and VNA3 (green) located at Halvfar Ryggen ( $70^{\circ}55'S$ ,  $007^{\circ}24'W$ ) and Søråsen ( $71^{\circ}15'S$ ,  $009^{\circ}40'W$ ) respectively. Major tasks are supply traverses (red) for Kohlen Station via Kottas Mountains over a distance of 750 km up to the inland ice plateau. As Atka Bay is also used as unloading site for supplying the South African station SANAE IV (yellow square) a separate route (yellow) was traversed to this station over a distance of about 300 km. The map is retrieved and modified from radar sat mosaic.

**Abb. 13:** Außenstationen bei NM-II, die regelmäßig logistisch betreut werden müssen. Dazu gehören die Außenstationen des Geophysikalischen Observatoriums VNA2 und VNA3 (grün) auf dem Halvfar Ryggen bei  $70^{\circ}55'S$ ,  $007^{\circ}24'W$  bzw. auf dem Søråsen bei  $71^{\circ}15'S$ ,  $009^{\circ}40'W$ . Wichtigste Aufgaben sind die Versorgungsfahrten zur Kohlen-Station auf dem Inlandeisplateau über eine markierte und beflaggte Wegstrecke (rot) von mehr als 750 km. Seit Südsommer 2005/2006 wird auch die südafrikanische Station SANAE IV (gelb) von der Atka-Bucht aus über eine Wegstrecke (gelb) von 300 km versorgt. Die unterlegte Karte wurde vom RADAR-Sat-Mosaik übernommen und modifiziert.

weather conditions a traverse takes 9 to 14 days one way. 100 to 150 tons of cargo and consumables have to be transported to supply the station for about 60 to 80 days of operations. Six tracked vehicles, twelve sledges carrying piece goods and containers, and five sledges with tank containers are typically arranged for these deep field supply traverses (Fig. 12B). Additionally small aircraft support this mission to carry personnel and scientific cargo from or to NM-II or directly from Novo-Runway to Kohnen Station.

#### DRONNING MAUD LAND AIR NETWORK – INTERCONTINENTAL AIR-LINK TO NEUMAYER II

Since 2002 the AWI has been actively involved to get established a new international partnership for air operations into and within Dronning Maud Land (DML). The Cape Town airport became the gateway for Dronning Maud Land Air Network (DROMLAN), the first international framework organised by the national Antarctic programs of Belgium, Finland, Germany, India, Japan, The Netherlands, Norway, Russia, South Africa, Sweden, and the United Kingdom (Fig. 14). The DROMLAN community coordinates all activities such as intercontinental flights between Cape Town and DML, connecting flights (feeder flights) to stations and field sites in the region, maintenance and operation of two airfields for

landing of heavy wheeled aircraft, provision of flight weather forecast for both the intercontinental flights and feeder flights between the stations Halley (UK) and Syowa (Japan), and organisation of pre-flight services and briefings in Cape Town.

For landing of heavy wheeled aircraft runways are prepared every season at Novo-Airbase (70°51'S, 011°36'E), located close to the Russian station Novolazarevskaya, and – beginning in austral summer 2005/2006 – at the Norwegian station Troll (72°00'S, 002°32'E). The runway at Novo-Airbase at about 550 m ASL consists of compacted snow. It is operated by the Russian Antarctic Expedition (RAE). The runway close to Troll station at an elevation of about 1,300 m ASL consists of blue ice. Because of its higher elevation no surface melting occurs at this runway, and it can be used even during mid-summer season. It is operated by the Norwegian Antarctic Research Expedition (NARE).

The majority of intercontinental flights between Cape Town and Novo-Airbase is performed with the cargo aircraft Ilyushin (IL-76TD; Fig. 15). The aircraft IL-76TD is mobilised and operated by a commercial enterprise – Antarctic Logistic Centre International (ALCI), Cape Town. Mid-season intercontinental flights to Troll airfield are currently performed with the Lockheed Orion P3N aircraft mobilised by NARE.

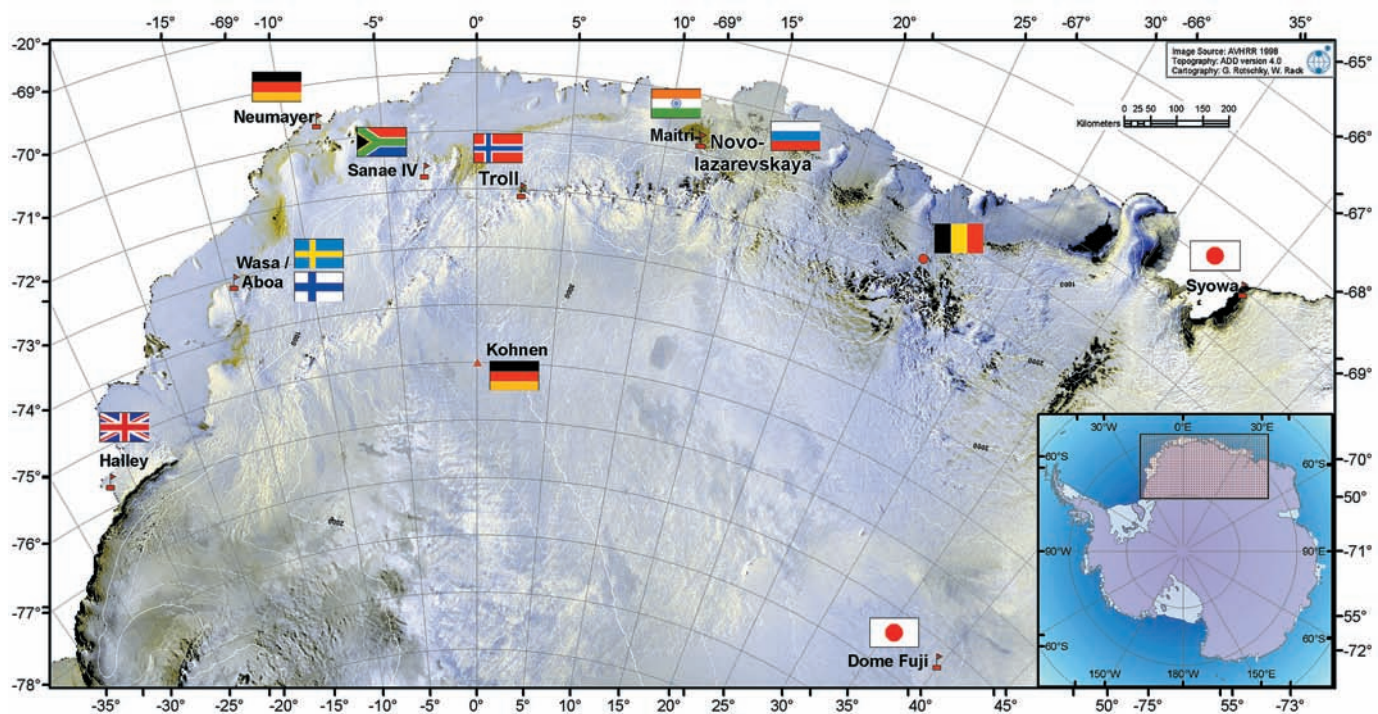

**Fig. 14:** Antarctic destinations of the DROMLAN (Dronning Maud Land Air Network) community. Supported by AWI a new international partnership has been formed to organise an air-gateway from Cape Town into Dronning Maud Land in 2002. DROMLAN members are the national Antarctic programs of Belgium, Finland, Germany, India, Japan, The Netherlands, Norway, Russia, South Africa, Sweden, and the United Kingdom. Runways for intercontinental flights with heavy wheeled aircraft can be operated close to the Russian station Novolazarevskaya and the Norwegian station Troll respectively. Commuter flights (feeder flights) are performed with small ski-equipped aircraft to stations and field sites in the region. NM-II is responsible for running the weather forecast centre for intercontinental flights and feeder flights in the area between the stations Halley (UK) in the west and Syowa (Japan) in the east, covering a distance of approximately 2500 km (map courtesy by G. Rotschky, AWI).

**Abb. 14:** Forschungsstationen, die von DROMLAN (Dronning Maud Land Air Network) bedient werden. Unter Mitwirkung des AWI wurde 2002 die internationale DROMLAN-Partnerschaft gebildet, um eine Luftbrücke von Kapstadt ins Dronning-Maud-Land einzurichten. Mitglieder von DROMLAN sind die nationalen Organisationen für die Antarktisforschung aus Belgien, Finnland, Großbritannien, Deutschland, Indien, Japan, Niederlande, Norwegen, Russland, Schweden und Südafrika. Zwei mögliche Landebahnen stehen bei Bedarf für interkontinentale Flüge von Kapstadt in die Antarktis bei den Stationen Troll (Norwegen) und Novolazarevskaya (Russland) zur Verfügung. Die Zubringerflüge zu den Stationen oder für Feldeinsätze werden mit kleineren, mit Skifahrwerk ausgerüsteten Maschinen, durchgeführt. NM-II ist das Zentrum für die Flugwetterberatung sowohl der interkontinentalen Flüge als auch für die Flugeinsätze in der Region zwischen den Stationen Halley (Großbritannien) im Westen und Syowa (Japan) im Osten über ca. 2500 km (Karte G. Rotschky, AWI).

Almost all feeder flights from Novo-Runway and Troll are made with a smaller ski-equipped aircraft (Basler BT-67), which is capable of landing on all snow runways at the stations and even on unprepared snow surfaces at field sites (Fig. 16). The BT-67 is operated by ALCI. If required, national operators as members of DROMLAN additionally support the feeder flight service with aircraft Dornier 228-101 (AWI) and Twin Otter (BAS). All members of the community provide meteorological data, support flight following, and ensure fuel provisioning and accommodation at their respective stations.

The number of flight missions depends on logistic and scientific requirements of the DROMLAN community. The coordination of flight schedules is performed by DROMLAN members in cooperation with ALCI, which also provides all pre-flight services in Cape Town. About six to seven IL-76TD flights take place to Novo-Airbase between November and February every austral summer, and up to three flights to Troll during mid-season. Up to 250 scientist and technicians including about 20 to 25 ton of cargo are transported via this air link.

DROMLAN enables a very efficient access for AWI activities into Antarctica. The NM-II station and the summer only Kohnen Station can both be reached within few days during the period from November until February. Every austral summer since 2003 up to 65 scientists and technicians as well as three to eight tons of scientific instrumentation were transported via this air-link. A significant benefit was obtained during the final EPICA ice core drilling in season 2005/2006, when all 26 scientists, technicians and 7400 kg of cargo for the Kohnen Station were directly flown in and out via Novo-Airbase. The first BT-67 aircraft landed at the station very early in the austral summer on 6 November 2005. Because of this early access the drilling works could be finalised within 90 days – the longest working period ever realised at Kohnen Station during one austral summer. Without aircraft access an additional full season operation would have been necessary to achieve the same result.

To make DROMLAN so successful the AWI regularly makes significant contributions. Since austral summer 2002/2003 the meteorological observatory at NM-II provides the flight weather forecast service in the scope of DROMLAN (KÖNIG-LANGLO et al. 2007). This service is performed in close cooperation between the AWI and the German Weather Service (DWD). Every season two qualified forecasters of the DWD share this task. NM-II provides the necessary communication facilities including a permanent satellite data link (128 kbit s<sup>-1</sup>, Intelsat), and the modern infrastructure of the meteorological observatory. Beside the data of the meteorological observatory up to 300 Mbyte of meteorological data from other Antarctic stations, automatic weather stations and numerical forecast data products are daily received. The forecasts are based on special model outputs from the European Centre for Medium-Range Weather Forecasts (ECMWF), the Antarctic Mesoscale Prediction System (AMPS) and the Global Model (GME). New outputs from these models are available twice a day. They are used to cover a forecast period up to one week. For short-term forecasts – crucial for feeder flight activities – the satellite image receiving station (HRPT, Seaspace) of the meteorological observatory at is of fundamental importance. Data of up to 20 satellite passes can be obtained daily from NOAA 17 and 18, DMSP 14, 15 and 16). Visual as well as



**Fig. 15:** Iljushin (IL-76TD) take-off from Novo-Runway (70°51'S, 011°36'E), which is located on the inland ice at an elevation of 550 m ASL about 15 km southward of the Russian station Novolazarevskaya in the Schirmacher Oasis. The landing strip is prepared by compacted snow and certified for landing of heavy wheeled cargo aircraft such as IL-76TD or Hercules C-130. The size of the runway is 2980 m by 60 m. Since season 2002/2003 Novo-Airbase is operational every year from the beginning of November until mid-February.

**Abb. 15:** Start einer Iljushin (IL-76TD) von Novo-Runway (70°51'S, 011°36'E) in einer Höhe von 550 m ASL auf dem Inlandeis etwa 15 km südlich von der russischen Station Novolazarevskaya in der Schirmacher-Oase. Die Landebahn besteht aus kompaktiertem Schnee und ist zertifiziert für Landungen schwerer Transportflugzeuge wie Iljushin IL-76TD, Hercules C-130 und andere. Die Landebahn ist 2980 m lang und 60 m breit. Seit der Saison 2002/2003 ist Novo-Runway jeweils von Anfang November bis Mitte Februar in Betrieb.



**Fig. 16:** A Basler BT-67 aircraft performs most of the commuter flights to all destinations of the DROMLAN community.

**Abb. 16:** Mit einer Basler BT-67 werden die meisten Verbindungsflüge zu den Stationen im Dronning-Maud-Land durchgeführt.

infrared images are geocoded automatically and are obtained in a variety of masters covering the synoptic scale (2,500 x 2,500 km) down to local scale with a spatial resolution down to 500 x 500 m. Additionally, all information from Global Telecommunication System (GTS) is available via the permanent data link at any time. Also measurements from surrounding automatic weather stations, transponding via ARGOS but not included into the GTS, are automatically extracted from NOAA-satellite information. The forecaster can be reached at any time by all DROMLAN members via e-mail, fax, telex, phone, and short wave communication. Forecast information can also be obtained via Iridium.

DROMLAN stands as an example of international cooperation in science and logistics. The network is open to any member country of COMNAP and SCAR to benefit from this very efficient airlink into DML. The Neumayer Station II contributes a major part in making possible these extended aircraft operations in the DML region and beyond with its high standard meteorological observatory and qualified forecasters.

#### NEW CONSTRUCTION CONCEPT for Neumayer III – REQUIREMENTS AND CHALLENGES

The first Neumayer Station (Georg von Neumayer, GvN) at Atka Iceport was built during the 1980/81 austral summer and started operation in March 1981 (ENSS 1981, ENSS 1981a). It was an underground station made of corrugated steel tubes with containerised and heated accommodation insides. This construction has certain advantages in the rough environment of an Antarctic ice shelf, but it is also exposed to the ever increasing loads of accumulating snow, which eventually will lead to the unavoidable destruction of the building. GvN lasted for eleven years and was replaced in 1992 by the present station NM-II, which is a very similar construction put up about 7 km further south. On account of increasing requirements of science and growing logistic activity this second station had to be built bigger in size (Fig. 17). Space capacities for both stations are compiled in Table 2. Some constructional improvements were made, e.g. a changed geometry of the tube section, and the innovative garage building (Fig. 18), which can be kept at the growing snow surface and at the same time connected to the station tubes. This station is meanwhile covered by about 9 m of snow, and will bear the increasing loads through 2009 at the longest (Fig. 19 A,B). In order to provide safe access to such underground stations all stairways, ramps and also all cables, pipes and air ducts leading to the surface must be extended again and again.

The above mentioned scientific and logistic activities are to be continued at the Ekström Ice Shelf and at Kohnen Station. This also includes new deep field traverses on the inland ice plateau and extended aircraft missions in Antarctica. Consequently the continuation of long-term scientific and political commitments, new research projects and the function as a logistic base for German and international logistic cooperation such as DROMLAN justifies an advanced replacement of the current Neumayer Station II. Here – after having used the underground steel tube concept with limited lifetime twice – a new concept has to be developed. It is keyed to keep the build-

Facilities	GvN (m <sup>2</sup> )	NM-II (m <sup>2</sup> )	NM-III (m <sup>2</sup> ) planning Nov. 2006
Warm areas	416	914	1850
Cold areas	675	2015	2523
Total protected areas	1091	2929	4473
- thereof science facilities	55	119	265
- thereof summer base	separate c. 100	separate c. 130	172
- thereof vehicle parking area	separate c. 200	c. 775	1659

Tab. 2: Space capacities of Neumayer stations.

Tab. 2: Platz- und Raumkapazität der verschiedenen Neumayer-Stationen.

ing at or above the snow surface and to prolong its operational lifetime so that the renewal intervals get longer. It has also to take into account that all structures should remain accessible for dismantling and removal in compliance with the requirements of the Protocol on Environmental Protection to the Antarctic Treaty (ENSS 2000).

Neumayer Station III will feature above-ground and below-ground facilities combined in one large building, which can be raised hydraulically to compensate snow accumulation. The

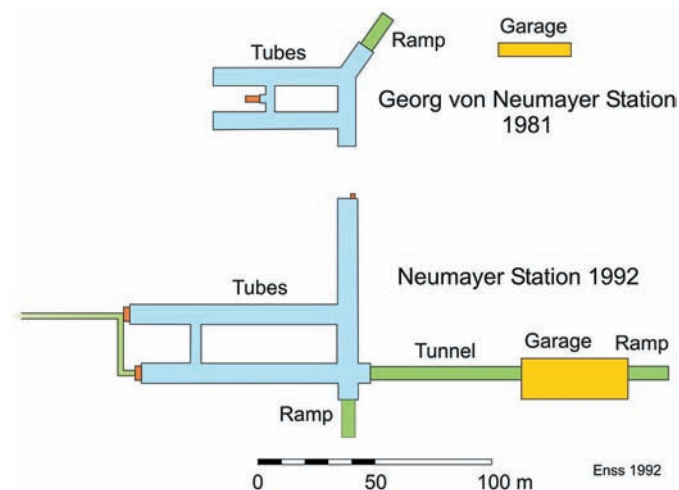

Fig. 17: Comparison of layout and size of the tube structures of the old station Georg von Neumayer (GvN) and the present station Neumayer II (NM-II) shows the growing capacity and construction improvements of NM-II. The protected/heated areas doubled from 1,160/416 m<sup>2</sup> to 2,250/816 m<sup>2</sup>, respectively. The garage trench at GvN was a separate structure but it is now connected through a tunnel with the station tubes at NM-II.

Abb. 17: Der Vergleich der Abmessungen der Röhrenkonstruktionen der alten Georg-von-Neumayer-Station (GvN) und der derzeitigen Neumayer-Station II (NM-II) zeigt die Zunahme der Kapazität und die konzeptionellen Verbesserungen. Die geschützten, bzw. beheizten Flächen haben sich nahezu verdoppelt von 1.160 bzw. 416 m<sup>2</sup> auf 2.250 bzw. 816 m<sup>2</sup>. Zudem war an GvN die Garage getrennt von der Station; bei NM-II besteht ein geschützter Zugang durch einen Eistunnel zur Garage.



Fig. 18: The innovative garage trench at NM-II under construction. The roof can easily be lifted up and the garage floor backfilled with snow in accordance with yearly snow accumulation while the garage remains accessible through a tunnel with the station tubes.

Abb. 18: Bau des neuartigen Garagengrabens an NM-II. Entsprechend dem Schneezutrag kann das Dach einfach angehoben, der Garagenboden mit Schnee aufgefüllt und erhöht werden. Gleichzeitig wird die Verbindung zur Station durch einen Eistunnel aufrechterhalten.



**Fig. 19:** Deformation of Neumayer Station II in the 13th year of its existence. A = View into the 92 m long cross tube, where the diesel tanks are mounted. The deformation of the tube, caused by the permanently increasing load of accumulated snow, can clearly be seen. B = View into the tunnel connecting the tube system with the garage. To keep a sufficient tunnel height, the compressed snow has to be cut out every third year.

**Abb. 19:** Verformung der Neumayer-Station II im 13. Jahr des Bestehens. A = Blick in die 92 m lange Querröhre, wo auch die Dieseltanks für die Kraftstation untergebracht sind. Die fortschreitende Deformation der Stahlröhre, verursacht durch die zunehmende Schneelast, ist deutlich erkennbar. B = Blick in den Schneetunnel, der die Stationsröhren mit der Garage verbindet. Um den Tunnel passierbar zu halten, muss der zusammengepresste Schnee jedes dritte Jahr herausgeschnitten werden.

whole structure rests on columns reaching from the platform down to shallow foundations at the trench bottom below the snow surface. A flat, rigid roof covers the trench section. The combination of an elevated platform with a trench section underneath improves the conditions of operation and the working conditions, because the complete station will be kept at a predetermined level in relation to the snow surface. Hereby the service lifetime of the station will be considerably prolonged when compared with the previous stations, and maintenance expenditures will be reduced as well. It also makes it dispensable to jack up some single outer structures additionally as necessary at the present station every year. The lifetime of this structure will no longer depend on snow accumulation and on increasing snow pressure but only on its movement with the flow of the ice shelf. Stress from hori-

zontal deformation of the ice sheet will not harm the building because the foundations will be raised from ground when backfill snow is placed underneath once a year. A significant longer service lifetime – estimated 25 to 30 years – can therefore envisaged.

The construction site has to be selected further south of the present station so that there will be no danger of getting too near to the breaking edge of the ice shelf during the planned service life.

Following this concept the major challenges are:

- to find a suitable location on a flow line not too far away from the ship's landing place where the least deformation will be encountered during the lifetime of the station;
- to design the statics for the platform structure and foundations which are able to withstand differential ground deformation and uneven settlements of the flowing ice shelf;
- to determine the bearing capability of the snow ground for shallow foundations;
- to design an aerodynamically shaped structure above ground to limit the generation of snow mounds;
- to develop a hydraulic jacking concept to compensate snow accumulation and to keep the entire structure at the level of the snow surface; and
- to make sure that no building parts are embedded deeper and deeper in the snow ground over the time.

#### DETERMINATION OF THE CONSTRUCTION SITE – ICE SHELF DYNAMICS

The Ekström Ice Shelf is not freely floating in the area but moves over ridges rising from the bottom of the sea to the north and east of the station area. This leads to extended zones with strong shear and a larger variation of the deformation vectors. Extensive observations and surveys have been carried out to determine shear zones, ice flow and differential horizontal deformations of the ice in the vicinity of the planned station (Fig. 20A).

Using ERS-1 SAR interferogram (Fig. 20B) and coherence images, shear zones and tidal flexure zones of the Ekström Ice Shelf can be identified. Zones with very big shear deformation are located quite near to others with comparable little differential movement and corresponding small differences in flow rates (Rack & Klenke pers. comm. 2005). The planned service time of the new station of 25 to 30 years calls for a positioning far enough south. The station will move with the flowing ice during this time towards the area where the predecessor station NM-II is situated now. Based on satellite observations and taking the logistic restraints into consideration, an area has been chosen due south of the present base for further detailed investigation.

To determine the best location for construction in the designated area it is necessary to know both the absolute movement and the differential deformation of the Ekström Ice Shelf. The parameters of horizontal strain at the surface (compression and expansion vectors) were measured repeatedly in the designated area since 2003 using a geodetic GPS reference network (Schenke, Krömer, Schulte & Weidt pers. comm. 2006). A rectangle of observation points arranged at rectangular

distances with sidelengths of 5 km in E–W and 7 km in N–S direction was set up southwest of NM-II. This area is safe although only a few kilometres away from a crevassed shear zone in the west, extending from the NE corner of Halvfår Ryggen to the SE corner of Atka Bay and disappearing gradually some kilometres ESE of NM-II. The spacing of the observation grid is 1000 m. Initial positions of the grid points were determined by GPS. The changed positions of all points were calculated using differential GPS measurements. Two reference receivers were used, one in the centre of the observation grid and one fixed at NM-II.

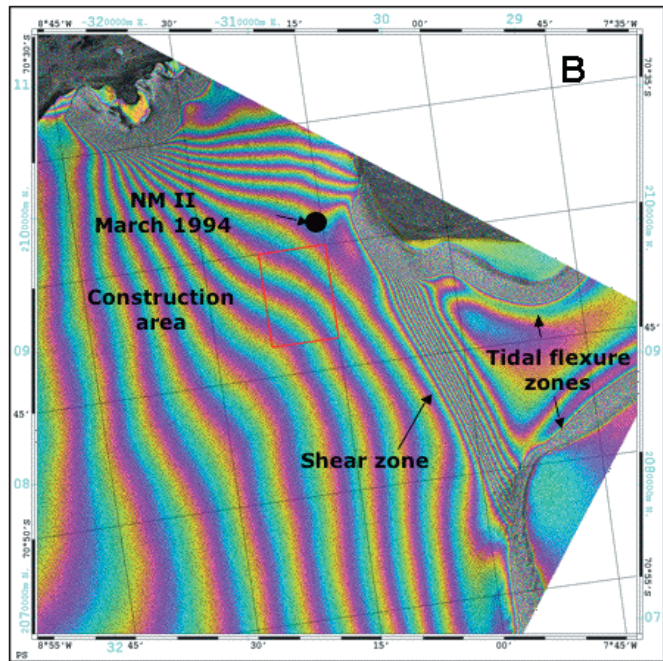
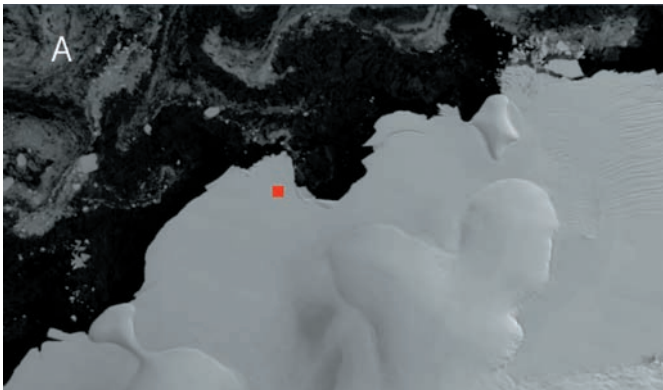

**Fig. 20:** Determination of the optimal construction site for the new Neumayer Station III (NM-III).  
 A = Satellitenfoto mit Übersicht über Atkabucht und Ekström-Schelfeis; rotes Quadrat = Lage der Neumayer-Stationen; Bildbreite ca. 400 km.  
 B = ERS-1 SAR Interferogramm aufgenommen vom 2. bis 5. März 1994, das die Scherungen und Gezeitenbewegungen im Eis zeigt; Bildgröße ca. 45 x 45 km. Markiert sind die Positionen der NM-II = schwarzer Kreis und das für den Bau von NM-III untersuchte Gelände = rotes Rechteck (Rack et al. pers. comm. 2005).

**Abb. 20:** Festlegung des optimalen Bauplatzes für die neue Neumayer-Station III (NM-III).  
 A = Satellitenfoto mit Übersicht über Atkabucht und Ekström-Schelfeis; rotes Quadrat = Lage der Neumayer-Stationen; Bildbreite ca. 400 km.  
 B = ERS-1 SAR Interferogramm aufgenommen vom 2. bis 5. März 1994, das die Scherungen und Gezeitenbewegungen im Eis zeigt; Bildgröße ca. 45 x 45 km. Markiert sind die Positionen der NM-II = schwarzer Kreis und das für den Bau von NM-III untersuchte Gelände = rotes Rechteck (Rack et al. pers. comm. 2005).

The analyses of these data including results from previous surveys show the movement along the flow line for the coming 20 to 30 years (Fig. 21). The mean velocity is of about 157 m per year towards the breaking edge about 16 km farther north. In 2009 the initial position of NM-III will be at 70° 40.8'S, 008° 16.2'W. During 25 years the station will move about 4.5 km almost north bound along a flow line curved about nine degrees clockwise. Along this flow line the horizontal deformation rates will remain smaller than ±1 ‰ per year mean deformation (strain and compression). The turn of the flow line has to be taken into account, as the orientation of the station must be aligned due crosswise to the direction of the prevailing wind. It is planned to minimize the effects of the expected turn by presetting the station axis by four degrees to the optimal orientation. According to these survey results the selected location on the Ekström Ice Shelf is most appropriate (Fig. 22). With respect to the regulations of the Environmental

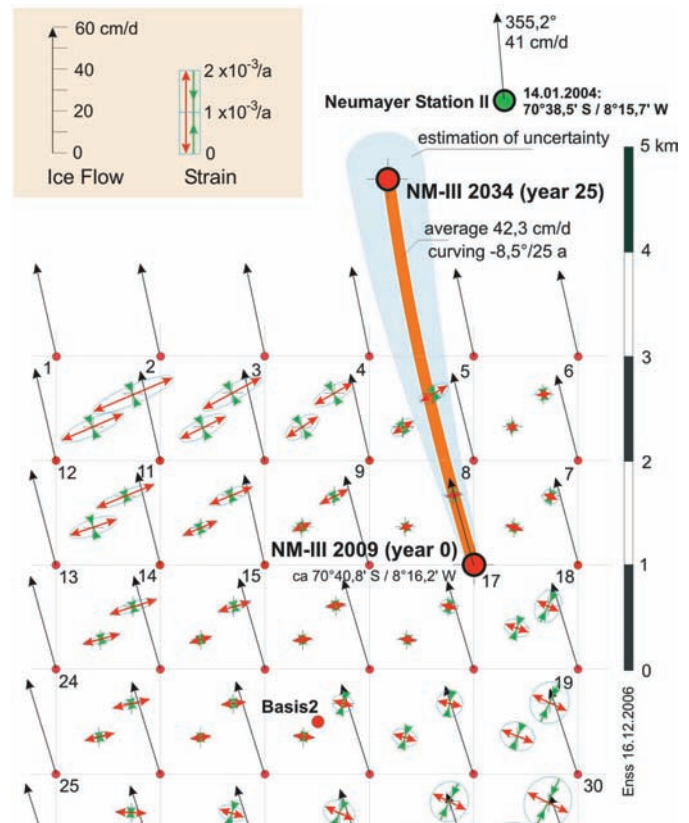

**Fig. 21:** Ice flow and horizontal ice deformations as retrieved from GPS measurements from 2003–2005. Mean ice flow (black arrows, cm day<sup>-1</sup>) is of about 157 m year<sup>-1</sup> towards the breaking edge farther north. The horizontal deformation rates (rote und grüne Pfeile, Maßstab ‰ Jahr<sup>-1</sup>) sind <1 ‰ Jahr<sup>-1</sup> für die Anfangsposition 70°40.8'S, 008°16.2'W chosen for the place where NM-III shall be positioned at completion in 2009, and similarly small along the 4.5 km long path it will move during its lifetime. At the end (2034) NM-III will approach the area where NM-II was located in 2004 (green dot). The estimated influence of the uncertainty of the ice flow is indicated as well (Schenke et al. pers. com. 2006, Enss pers. com. 2006).

**Abb. 21:** Eisbewegung und horizontale Deformation nach GPS-Messungen in den Jahren 2003–2005. Die mittleren Eisflüsse (schwarze Pfeile, cm Tag<sup>-1</sup>) betragen 157 m Jahr<sup>-1</sup> in Richtung Schelfeiskante. Die horizontalen Deformationsraten (rote und grüne Pfeile, Maßstab ‰ Jahr<sup>-1</sup>) sind <1 ‰ Jahr<sup>-1</sup> für die Anfangsposition 70°40,8'S, 008°16,2'W bei Fertigstellung in 2009 und ähnlich klein entlang des ca. 4,5 km langen Weges, den NM-III während ihrer gesamten Lebenszeit zurücklegen wird. Am Ende (2034) wird NM-III das Gebiet erreicht haben, in dem sich NM-II noch 2004 befand. Der Unsicherheitsbereich für die Driftrichtung und Geschwindigkeit des Eises ist ebenfalls markiert (Schenke et al. pers. Mitteil. 2006, Enss pers Mitteil. 2006).

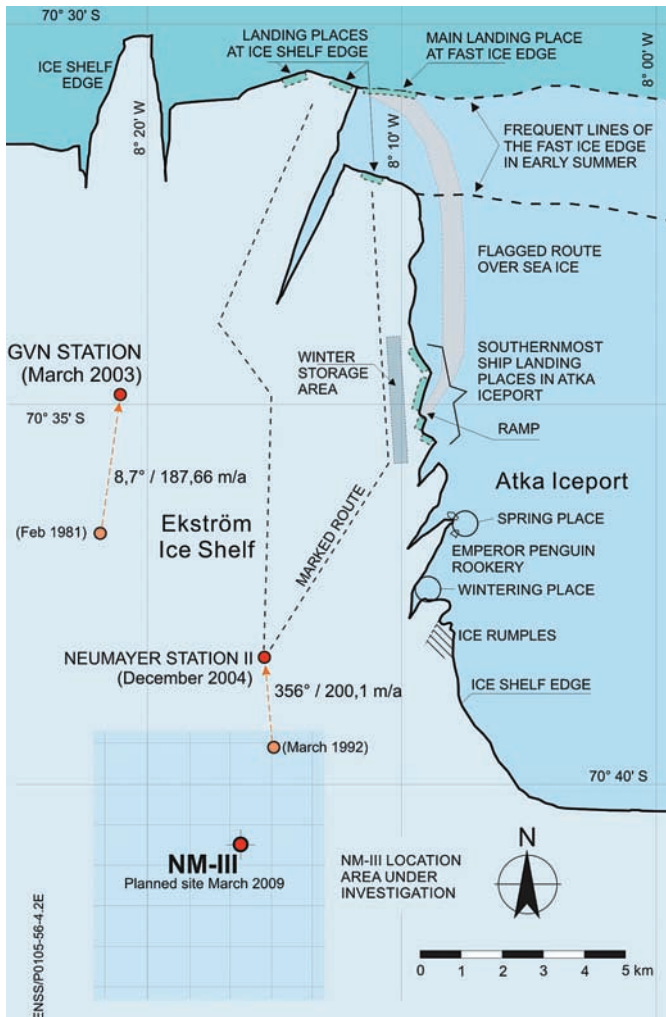

**Fig. 22:** Detailed map of the Ekström Ice Shelf and Atka Iceport with the initial and later positions of stations GvN (1981/2003) and NM-II (1992/2004). The various landing sites for unloading supply vessels, transport routes, winter storage area and other details are shown (Enss pers. com. 2006).

**Abb. 22:** Detailkarte des Ekström-Schelfeises und der westlichen Atkabucht mit den Anfangs- und Endpositionen der Stationen GvN (1981/2003) und NM-II (1992/2004). Die verschiedenen Entlastestellen für die Schiffsversorgung an der Schelfeiskante, Transportwege, Winterlager und weitere Einzelheiten sind markiert (Enss pers. Mitteil. 2006).

Protocol care has been taken to keep the station sufficiently far away from the Emperor colony at Atka Bay.

### GENERAL DESIGN of Neumayer III

The general design was performed by the Joint Venture IMS Ingenieurgesellschaft mbH (Hamburg) and m+p consulting Nord GmbH (Braunschweig) from January until November 2005.

#### *Basic design of the building*

The station building proper, containing living and working space, will be two storied and placed above snow on an elevated platform. A shell is to protect this building from wind and, because of its aerodynamic shape, to reduce snow accumulation or erosion around the base. A trench in the snow

under the platform, accessible via a ramp, will serve as garage and cold storage room and provide room for an intermediate deck with various facilities and technical installations hanging to the flat, rigid roof that covers the trench in level with the snow surface. The legs or columns bearing the platform reach through this roof, actually also taking the loads of the roof and the deck underneath, and rest on flat foundations on the snow of the trench floor. The construction material is mainly steel, but light metal, timber, plastics, no CFCs containing insulation and other auxiliary materials will be used.

The load bearing steel structure of the building consists of a 3D-framework. It is sufficiently flexible to withstand deformation of up to  $\pm 2\%$  at foundation level. As the horizontal strain of ice shelf is only about  $\pm 1\%$  per year no bigger static stability of the structure is required, because the foundations will be lifted from the ground and tensions thus released every year when the station is raised to compensate snow accumulation.

The whole construction with its weight of approximately 2600 tons will be raised once a year by means of hydraulic jacks. The jacks are integrated pair-wise in the columns at the garage level and will allow easy, mostly automated adjustment for different settlements of individual foundations. An automatic, doubly laid-out monitoring system will continuously monitor settlements and give alarm whenever preset stability or deformation limits have been reached.

#### *Shallow foundation on snow*

Exceptional care had to be given to the design of the foundation of the new station. The accumulation rate, the bearing capacity for constant loading and the settling behaviour of snow determine the design of the foundations.

Over the last 25 years the local snow accumulation and snow densities retrieved from firm cores were recorded at stake arrays near to the stations (H. Oerter pers. comm. 2005). These long-term records were used to assess the local snow properties. Some selected data are shown in Table 3. For the period from 1982 to 1992 the mean snow growth rate is  $80.1 \text{ cm a}^{-1}$  with standard deviation  $\pm 16.5 \text{ cm a}^{-1}$ . The hydraulic lift has to be designed for compensation of this growth and so for keeping the entire station above the snow surface. After lifting up the building the foundation pads will be raised one by one for backfilling with snow underneath. Thereafter the load will again be transferred to the snow.

Studies on snow mechanics, time dependent settlement behaviour of snow, firm, and ice under permanent loading (BETTEN 2005, SHAPIRO et al. 1997, WU et al. 1993 and others), including the local data of snow properties, have been considered to determine the basic limitations for a shallow foundation on snow (Geduhn & Enss pers. comm. 2006). As the bearing capacity of snow increases substantially with depth the calculations were made for foundation pads with a size of  $4 \times 3 \text{ m}$  founded at least  $5 \text{ m}$  below the snow surface. The maximum possible short-term bearing capacity and the settlement behaviour of snow under permanent loading in the long term has been determined. So two different snow failure scenarios have to be investigated: (i) the snow bearing capacity or snow breaking strength and (ii) the visco-elastic properties of snow.



Snow growth, accumulation and standard deviations					
Location	Period (year)	Growth (cm a <sup>-1</sup> )	STD (cm a <sup>-1</sup> )	Accumulation (kg m <sup>-2</sup> a <sup>-1</sup> )	STD (kg m <sup>-2</sup> a <sup>-1</sup> )
Stake array NM-I	1982-1992	80	16	277	52
Stake array NM-II	1993-2002	69	23	240	79
Stake array south	1993-2002	99	32	394	128
Snow densities and standard deviations					
Depth (m)	Number	Density (kg m <sup>-3</sup> )	STD (kg m <sup>-3</sup> )		
0.0 m	11 pits	386	45		
0.5 m	11 pits	408	41		
1.0 m	11 pits	432	39		
1.5 m	9 pits	445	35		
2.0 m	4 cores	483	22		
3.0 m	4 cores	496	26		
4.0 m	4 cores	509	42		
5.0 m	4 cores	524	23		
6.0 m	4 cores	538	29		
7.0 m	4 cores	555	23		
8.0 m	4 cores	578	21		
9.0 m	4 cores	578	24		

**Tab. 3:** Mean values of snow growth, snow accumulation, and snow density recorded in the vicinity of Neumayer stations on Ekström Ice Shelf (OERTER 2005).

**Tab. 3:** Mittlere Werte für Schneeauftrag, Schneeeakkumulation und Schneedichte im Umfeld der Neumayer-Stationen auf dem Ekström Eisschelf (OERTER 2005).

### i) Snow bearing capacity

To carry heavy loads sufficient breaking strength (shear stability) of the snow is required, or a shear failure will occur shortly after load application and the foundation become unstable similar to the shear failure mechanism in cohesive or non-cohesive soils.

At the NM-III building the heaviest load on a foundation will be around 3200 kN during the short time when one of the edge-columns is relieved during the backfilling operation and loads are transferred to the neighbouring foundations. The corresponding pressure then increases up to 267 kN m<sup>-2</sup>, which the foundation exerts on the snow for that limited time span. Load tests at NM-II and calculations with the shear failure evaluation after the German Standard 4017 have shown that the bearing capacity of snow is considerably higher at least for a limited period of time, and no danger is envisaged here for the load during backfilling operation (Geduhn & Enss pers. com. 2006).

### ii) Visco-elastic properties of snow

In order to determine the long-term stability of a shallow foundation on snow the visco-elastic properties of snow under permanent high loads have to be considered. The creep of the snow, here best explained as settlement of the foundation pad per time increment, is not constant over time. The time dependent behaviour of the settlement, the settlement rate and acceleration of settlement are shown in Figure 23, where snow and ice are considered as a linear visco-elastic material (BETTEN 2005). During the first period, so called "primary creep", the settlement rate decreases with time. During the second phase or "secondary creep" the rate of settlement keeps constant. But

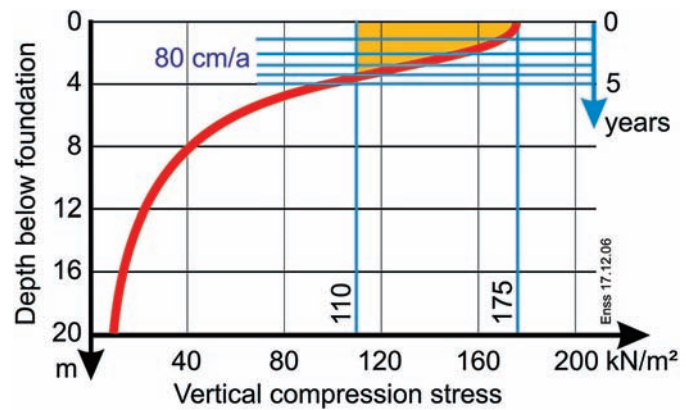

**Fig. 23:** Creep or settlement behaviour of snow under load as a function of time, when a certain snow-level, described as proportionality boundary (PB), is transgressed. Settlement, the settlement rate and acceleration of settlement are shown. During the first period, so called "primary creep" the settlement rate decreases with time. During the second phase or "secondary creep" the rate of settlement keeps constantly. In the third phase or "tertiary creep" the settlement rate increases exponentially. According to this model deformation of snow gets indefinite, because of non-linear processes, and might result in a complete instability of snow bearing ability under the foundation pads. Therefore, foundation pressures on snow must be kept below the PB, at least safely before the tertiary creep phase is reached (Enss pers. com. 2006).

**Abb. 23:** Kriech- und Setzungsverhalten des Schnees unter Last als Funktion der Zeit, wenn eine bestimmte Spannung, die als Proportionalitätsgrenze (PB) bezeichnet wird, überschritten wird. Setzung (obere Kurve), Setzungsraten (mittlere Kurve) und Setzungsbeschleunigungen (untere Kurve) sind dargestellt. Im ersten Zeitabschnitt, der so genannten „primären Kriechphase“, nimmt die Setzung mit der Zeit ab. Während des zweiten Zeitabschnitts, der „sekundären Kriechphase“, bleibt die Setzungsraten konstant. Im dritten Zeitabschnitt, der „tertiären Kriechphase“, nehmen die Setzungsraten exponentiell zu. Nach diesem Modell wird die Verformung des Schnees auf Grund nichtlinearer Prozesse unbestimmt, und es könnte zu einer vollständigen Instabilität der Fundamentgründung im Schnee kommen. Fundamentgründungen auf Schneegrund müssen deshalb unter der Proportionalitätsgrenze gehalten werden, zumindest bevor die tertiäre Kriechphase beginnt (Enss pers. Mittel. 2006).

for the third phase or "tertiary creep" the settlement rate increases exponentially. During the tertiary creep the bearing ability of snow might not be sufficient for the applied load, because non-linear processes of the creep failure mechanism might result in an indefinite instability of snow under the foundation pads after  $t_2$  (Fig. 23).

The least stress on snow or least permanent load on snow leading to a creep failure after a certain period of time is determining the so-called proportionality boundary (PB) of snow (DÖRR et al. 1983). Following the creep failure mechanism, reliable foundations can be set with permanent loading below the PB. However, the PB cannot easily be determined, especially when snow parameters vary widely or are not sufficiently known in detail. In order to keep sufficient safety margin with respect to the PB, the limiting values as assumed reasonable for the foundation at 5 m below the snow surface have thus been set to 110 kN m<sup>-2</sup> permissible stress with an estimated proportionality boundary at 180 kN m<sup>-2</sup> (Enss pers. com. 2005, Geduhn pers. com. 2006; Tab. 4).

Even though the permanent pressure with about 175 kN m<sup>-2</sup> for some of the given foundation pads is higher than the above set limit. The pads cannot be designed larger than 4 x 3 m for technical and operational reasons. But the vertical stress is "dispersed" quickly with increasing depth due to the shear strength of snow, which has been compressed by the overburden and/or the column load (Fig. 24). The calculation

Snow depth	Proportionality boundary	Permissible stress
Near surface	100 kN m <sup>-2</sup>	60 kN m <sup>-2</sup>
5 m	180 kN m <sup>-2</sup>	110 kN m <sup>-2</sup>

**Tab. 4:** Proportionality boundaries and permissible stress as assumed for the design of the foundations for the Neumayer Station III (NM-III).

**Tab. 4:** Proportionalitätsgrenzen und aufgenommene zulässige Belastung für die Dimensionierung der Fundamente für die Neumayer-Station III (NM-III).

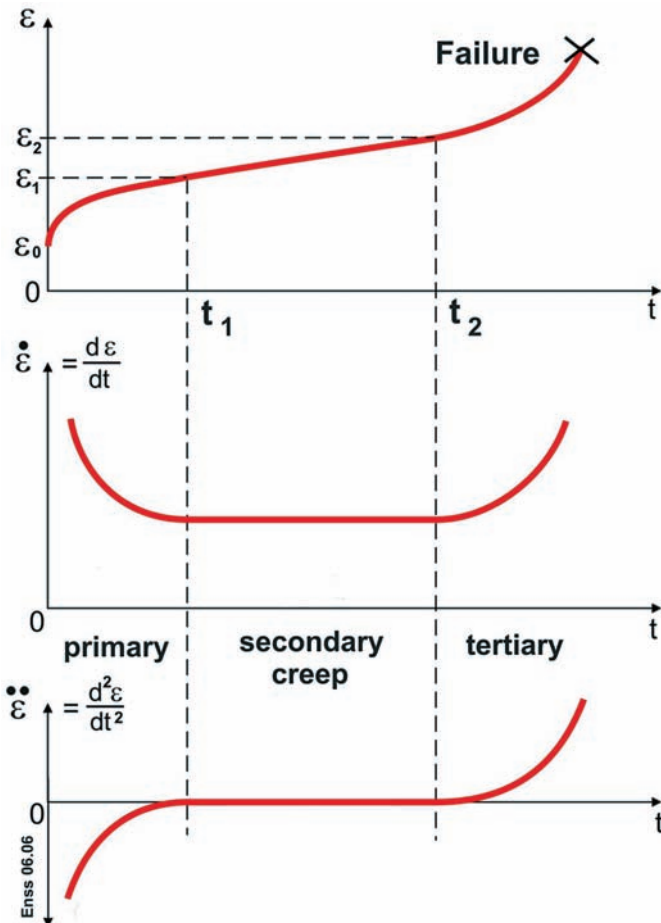

**Fig. 24:** Changes of vertical stress caused by dispersion as function of depth below a foundation pads. At 20 m below the foundation the stress is already almost negligible. By calculation it has been determined that the primary creep phase for a pressure of 175 kN m<sup>-2</sup> will last safely for 5 years, while the proportionality limit is at 110 kN m<sup>-2</sup> (see Fig. 23). At NM-III a pressure above the proportionality limit can be applied, because new snow will be backfilled under the foundation pads every year. With 80 cm of height adjustment per year the snow layer brought in over five years will have reached a thickness of 4 m (compare orange field), and at that depth under the foundation the pressure has decreased below the proportionality limit. Thus no snow under the foundations will be subject to vertical stress above the proportionality limit for longer than five years (The bearing capacity of ground snow after one day of age hardening is much higher than 175 kN m<sup>-2</sup>, Enss pers. com. 2006).

**Abb. 24:** Verlauf der vertikalen Druckverteilung als Funktion der Tiefe unterhalb einer Fundamentplatte. In 20 m Tiefe unter dem Fundament ist der Druck bereits vernachlässigbar. Berechnungen zeigen, dass die primäre Kriechphase bei einem Druck von 175 kN m<sup>-2</sup> mindestens fünf Jahre andauert, während die Proportionalitätsgrenze bei 110 kN m<sup>-2</sup> liegt (vgl. Abb. 23). Bei NM-III kann ein Fundamentdruck oberhalb der Proportionalitätsgrenze angesetzt werden, weil jedes Jahr neuer Schnee unterhalb der Fundamente eingebracht wird. Bei einem Höhenausgleich von 80 cm pro Jahr mit Schnee werden in fünf Jahren etwa 4 m Schnee eingebracht (siehe Orange farbiger Bereich); bei 4 m Tiefe unter dem Fundament liegt der Druck nicht mehr oberhalb der Proportionalitätsgrenze. Damit wird kein Schnee länger als fünf Jahre einem Druck oberhalb der Proportionalitätsgrenze ausgesetzt sein (Die Tragfestigkeit von gemahlenem Schnee nach einem Tag Altershärtung ist deutlich höher als 175 kN m<sup>-2</sup>, Enss pers. Mitteil. 2006).

considers the recorded depth-density profiles given in Table 3. At depths below 4 m under the foundation the vertical stress is smaller than the permissible stress set for the foundation, and at depths 20 m below the foundation there is almost no additional vertical stress left contributing to the settlement of snow. Settlement, deformation rate and deformation acceleration as a function of time have been calculated for a permanent pressure of 175 kN m<sup>-2</sup> in order to determine the duration of the primary creep phase (Geduhn pers. comm. 2006). For these conditions the primary creep phase – until  $t_1$  (Fig. 24) – will last between five and six years after installation and loading the foundation pads. The duration of the second creep phase, and the moment of a potential creep failure cannot be determined by the used model. But a creep failure can be excluded for the period of the first six years.

The conclusion for the case of NM-III is: when applying load above the PB one should make sure to limit the duration of the effected pressure of up to 175 kN m<sup>-2</sup> to less than six years. Fortunately this condition can be met. The snow under the foundation pads is not really permanently subject to this high pressure because 80 cm of backfill snow will be placed under the pads every year. Hereby no snow will be stressed to more than 110 kN m<sup>-2</sup> for longer than five years (Fig. 24). So the high annual growth rates of snow certainly constitute a technical challenge to keep the whole building at the snow surface but on the other hand make it possible to apply higher loads of a heavy building to shallow foundation on snow.

#### *Aerodynamic studies – hull shape, wind forces, snow deposition*

The aerodynamically shaped hull of the platform shall not only protect the inner parts of the building from wind but also help to reduce drift snow deposition around the new station building. The Environmental Wind Tunnel Laboratory of the Meteorological Institute at Hamburg University was tasked to deliver basic information on the wind fields and snow drift patterns to be expected around the building (LEITL et al. 2005). Based on wind data recorded at the existing NM-II, a scaled model boundary layer flow was established in the test section of the wind tunnel first. A scaled model of the planned station was built with several options for changing structural parameters like the height of the station platform above the snow surface, shape of the station outer contour or the location of structural attachments. Exemplary model results of this study were summarised in LEITL et al. 2006.

In order to study the aerodynamic behaviour of various shaped hulls an extensive set of qualitative LASER light sheet visualization experiments were performed (LEITL et al. 2006). In addition to the semi-circular contour proposed originally in the initial engineering designs of the concept, several triangular and trapezoid shapes were investigated. The visual assessment already showed a slightly better performance of the trapezoid contour with lower wind velocities below the station. The quantitative analysis of the flow field around the station confirmed that for the trapezoid contour a smaller fraction of the approach flow is pushed below the station. For the wind direction perpendicular to the station axis the flow field is shown for the centre cross section in Fig. 25. Strong vortex structures were seen at the lateral ends of the station body for

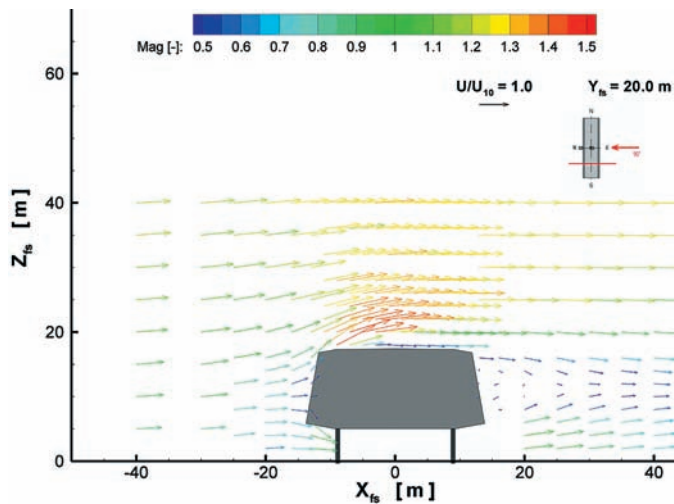

**Fig. 25:** Flow field for wind direction perpendicularly to station axis in the central section of NM-III. Quantitative analysis of the flow field around NM-III confirms that for the trapezoid contour a smaller fraction of the approaching flow is pushed below the platform because of the lower stagnation point (LEITL et al. 2005).

**Abb. 25:** Strömungsfeld für eine Anströmung senkrecht zu Längsachse des Stationsmodells von NM-III. Eine quantitative Untersuchung bestätigt, dass bei der Umströmung einer trapezförmigen Umhüllung ein geringerer Anteil der Strömung wegen des tiefer liegenden Staupunktes unterhalb der Plattform geführt wird (LEITL et al. 2005).

prevailing winds perpendicularly to the station axis. In order to avoid the development of these vortices protruding end plates were suggested and considered in the design of the hull.

A second test series was performed to study the snowdrift and the shear flow distribution above the snow surface. For the visualization of shear flow impact at the ground a so-called oil-soot-technique was utilised. For the snowdrift studies, the wind tunnel floor was replaced by a sufficient deep cavity filled with glass spheres in order to visualise the pattern of snow accumulation and erosion influenced by the upwind and downwind of the station body. The experiments were performed with 1:120 and 1:480 scaled models. By using the 1:480 scaled station-body the drift height of the modelled snow could be increased covering the entire station body. These cases have to be considered because at full scale under strong wind conditions the drifting snow can reach much higher than the height of the building. Fig. 26 shows an example how snowdrift is affected by the elevated 1:120 scaled station body. The wake of the piles carrying the station can clearly be identified. Depending on the height of the station piles, the vortex cones develop at both the windward and leeward side of the station. The drift patterns get weaker when the station is higher above the snow surface.

In the result of these studies the optimal height of the station platform was thus determined to be 6 m, and a suitable aerodynamic shape of the hull was found not only designed to reduce the turbulences and to avoid extreme vertical wind force components acting on the hull, but also to be feasible from standard faced panels. A further result, as already mentioned above, lead to the application of protruding panels at the ends of the hull which stop the wind flow from deviating at the outer edges and avoid adverse tip vortex effects.

In a third test series the wind loads were measured for seven

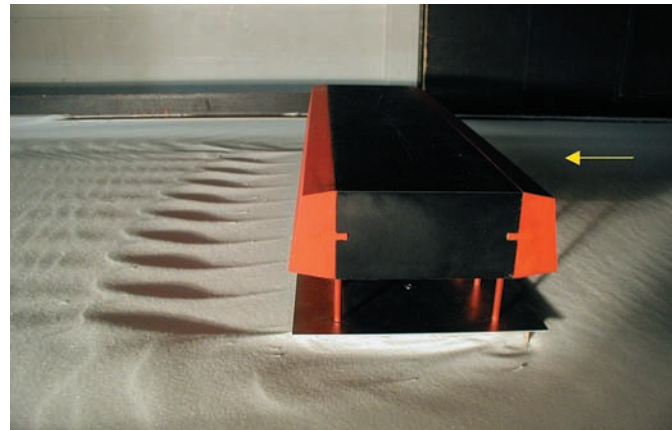

**Fig. 26:** Snowdrift studies with 1:120 scaled station body. In order to visualize the pattern of snow accumulation and erosion the wind tunnel floor was filled with glass spheres. The wake of the piles carrying the station can clearly be identified. Depending on the height of the station piles, the vortex cones develop at both the windward and leeward side of the station (LEITL et al. 2006).

**Abb. 26:** Schneedriftuntersuchungen mit einem Stationsmodell im Maßstab 1:120. Der Schnee wird mit Glasperlen simuliert. Die durch die Stützen verursachte Wirbelströmung bildet sich deutlich in den Schneeeablagerungen aus. Wirbelstromkegel bilden sich in Abhängigkeit von der Plattformhöhe an Luv- und Leeseiten der Station (LEITL et al. 2006).

different wind directions in order to determine the requirements on the stability of the hull (LEITL & SCHATZMANN 2005). The station model was equipped with altogether 72 pressure sensors distributed in several sections of the hull. The measured pressure values were scaled with the reference wind velocity measured at 10 m height in the undisturbed flow. The highest local wind pressure coefficient, suction as expected, was measured at the top edge of the windward side of the hull, when the prevailing wind direction is  $110^\circ$  to the axis of the station. These high local wind loads on the hull have to be considered for keeping an appropriate stability of the hull. The wind impact might be very strong. The relevant 2-second-gust wind speed can reach  $63 \text{ m s}^{-1}$  for a mean wind speed of  $45.7 \text{ m s}^{-1}$  as already recorded at the present NM-II.

## DETAILED ENGINEERING DESIGN

In August 2006 the contract for manufacturing and on site construction works was concluded between AWI and the Joint Venture Neumayer III – J.H.K. Anlagenbau GmbH & Co KG / KAEFER Isoliertechnik GmbH & Co. KG in Bremerhaven. The detailed engineering planning addressed construction details such as the statics of the whole steel structure and the stability of the aerodynamic shaped hull with respect to the anticipated wind loads as well as the performance of the service systems: power supply, heating, air conditioning, water supply, waste water treatment, etc. Based on the general design and on earlier studies construction parameters such as foundation loading, operational bearing capacity of the floors, energy consumption, performance of the hydraulic system, and others were checked, adjusted if necessary, and finally confirmed to be applied. In the result the engineering design for manufacturing provided feasible and even much more important economical solutions for all components of the station. Mainly because of economical constraints the whole compound became shorter in length as previously planned, and only 16 legs will bear the platform (Fig. 27).

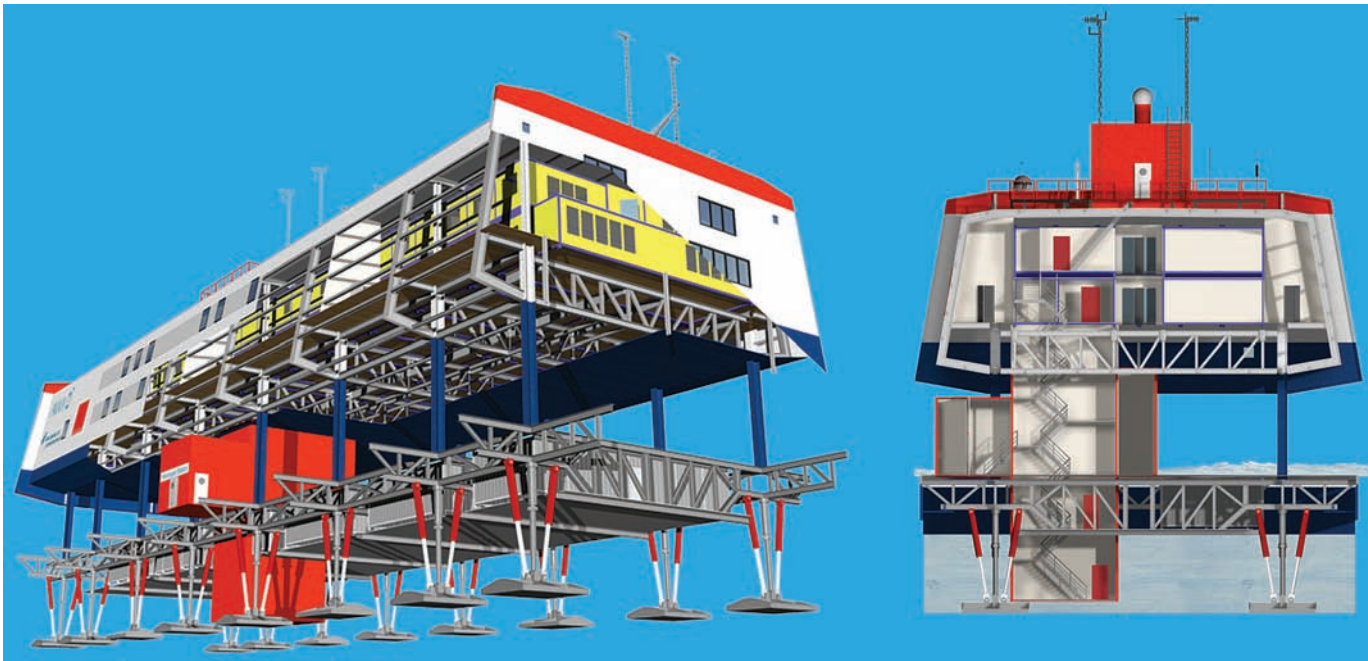

**Fig. 27:** Sideviews of the construction of the new Neumayer Station III (NM-III) according to planning as of December 2006. 16 legs with hydraulic units will be used to bear the whole construction. The two-storied warm part of the building (Deck 1, Deck 2) is accommodated on the 68 x 24 m large platform within the protective hull. The clear platform height is 6 m, and the height above the snow surface is 16 m without roof installations. The garage trench is 76 m long, 26 m wide and 8.2 m deep. Clear height in the garage is 4.6 m. The connection between garage and platform decks is via stairs and lift in the central section. The total elevation of the structure is 29.2 m from the garage ground floor (Deck U2) up to the roof of the balloon-launching shed (Any Motion/AWI).

**Abb. 27:** Seitenansichten der Konstruktion der neuen Neumayer-Station III (NM-III) nach Stand vom Dezember 2006). 16 Stützen mit hydraulischen Hebevorrichtungen tragen die gesamte Konstruktion. Der zweigeschossige beheizte Gebäudeteil (Deck 1, Deck 2) befindet sich auf der 68 x 24 m großen Plattform innerhalb der Schutzhülle. Die lichte Plattformhöhe ist 6 m, die Höhe bis zum Dach beträgt 16 m ohne Dachaufbauten. Der Schneegraben unterhalb der Plattform ist 76 m lang, 26 m breit und 8,2 m tief. Die freie Durchfahrthöhe in der Garage beträgt 4,6 m. Das Treppenhaus mit Lift verbindet die Garage mit den Plattformdecks. Die Gesamthöhe des Bauwerkes vom Garagenboden bis zum Dach der Ballonfüllhalle beläuft sich auf 29,2 m (Any Motion/AWI).

The two-storied building with its working, living and service spaces is accommodated on the elevated, 68 x 24 m large platform. The clear platform height is 6 m, the total height without roof installations is 16 m above snow surface. The garage trench is 76 m long and 26 m wide offering room not only to the plant and vehicle fleet of the base but also for additional storage. The trench depth is 8.2 m and the clear height in the garage is 4.6 m. The connection between garage and platform decks is via stairs and lift in the central section. The total elevation of the structure is 29.2 m from the garage ground floor (U2) up to the roof of the balloon-launching shed.

It has been possible to accommodate all required scientific, logistic and operational functions, namely to provide:

- Larger than before laboratories for observatories and scientific project groups;
- Accommodation for wintering and summer season personnel;
- Provision of all necessary technical service units, storage rooms, hospital, IT network and communication facilities; and
- Facilities for logistic operations – support of deep field traverses and aircraft missions.

According to the scientific and logistic commitments and envisaged new activities more space and laboratory capacity will be available than at the present NM-II (Tab. 2). The combined building will reduce the number of individual constructions needed for jacking up every year. Furthermore, various facilities and installations – so far separately placed on

the snow ground near the main building – can now be incorporated in or on the station building. Many of the antennas and the balloon-launching shed will be put on the roof of the building, and a good number of storage facilities will be moved from snow ground to the deck underneath the garage roof. The outstations of the observatories will be connected to the main building via cable and via radio links. High-capacity communication via satellites will be available for voice and data exchange.

#### *Station layout*

Based on planning stage of December 2006 Figure 28 gives a general view and impression of the construction. Figure 29 shows the layout of the decks D2 and D1 on the platform as well as the intermediate floor of Deck U1 and the garage in the ground floor of Deck U2 in the trench. The intermediate floor under the garage roof contains amongst other a large workshop, workshop storage rooms, hydraulics control room, cold provisions storage rooms and the snow-melting tank. Apart from the laboratories the laboratory store capacity has been enlarged due to urgent scientific needs. There will be special rooms in the new station for some of the works, which so far led to unwanted mutual interference, like a forecast-room for the meteorologists, and a clean air laboratory. Furthermore the servers will be accommodated in a special server room.

The leisure rooms are on one hand in keeping with the require-

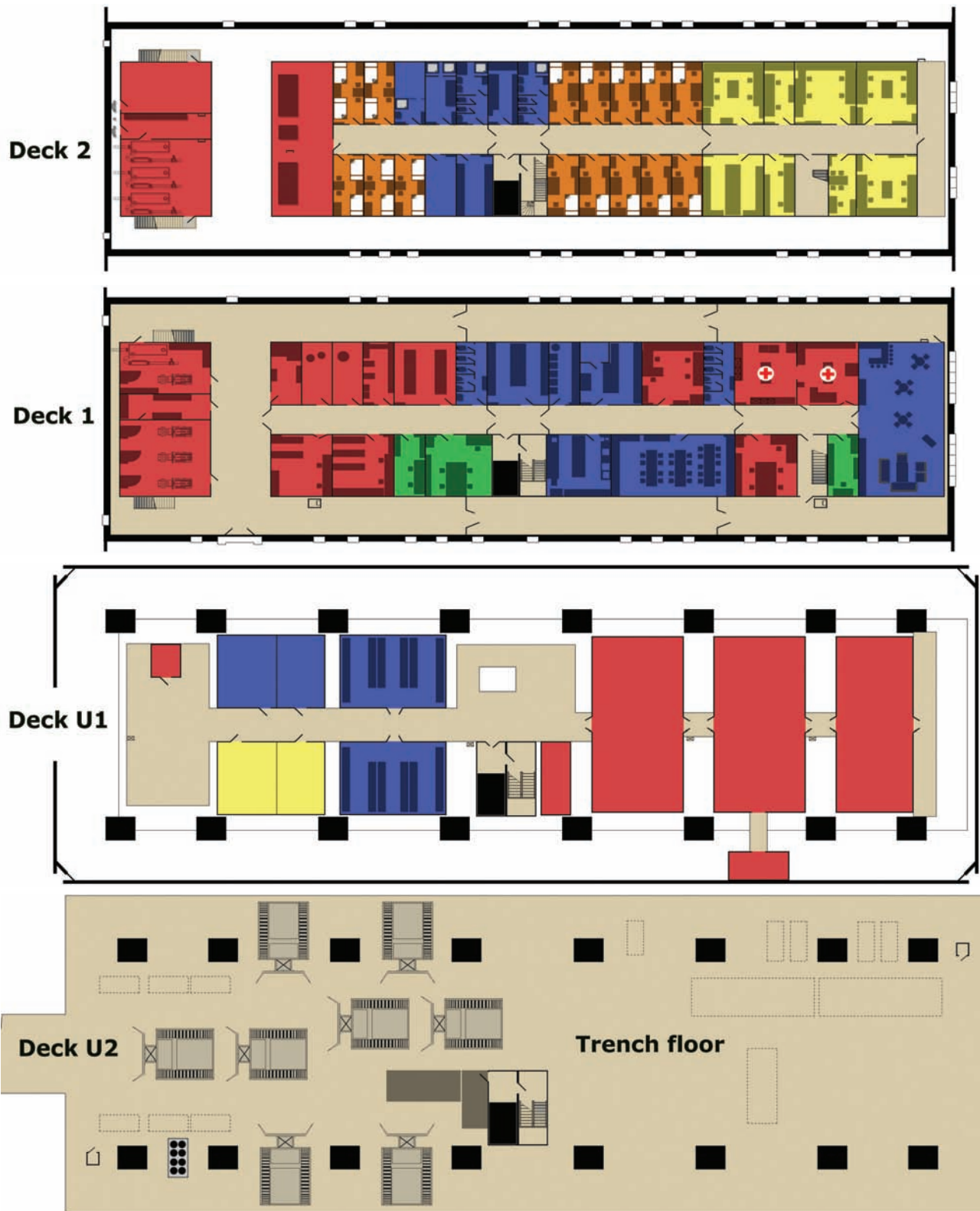

**Fig. 28:** Floor plan and layout of Neumayer Station III showing main levels of Deck 2, Deck 1, Deck U1, and Deck U2 (planning stage as of December 2006). Yellow = Scientific laboratories and storage rooms; brown = Living and sleeping rooms provide altogether 40 berths, where 10 rooms with two berths are allocated to the wintering staff; Blue = Social facilities comprise lounge, mess, kitchen, laundry, sauna, gym, sanitary, and corresponding storage rooms; red/red cross = Hospital will be accommodated in two rooms; red = Technical facilities are power plant, energy management, air conditioning, hydraulic system unit, workshops, and storage rooms; green = Working rooms for station management and control.

Deck U1 stretches over the full length of the garage trench, where mainly workshops and provision storage rooms as well as some technical installations (snow-melter, fuel pumping station, hydraulic control room) will be accommodated. Deck U2 is not only the garage for the tracked vehicle but also for additional storage (Any Motion/AWI).

**Abb. 28:** Grundrisse und Nutzungsplan der neuen Neumayer-Station III der Hauptgeschosse: Deck 2, Deck 1, Deck U1 und Deck U2. Gelb = Wissenschaftlichen Labore und Lagerräume. Braun = Wohn- und Schlafräume verfügen über 40 Betten, wobei 10 Räume mit jeweils zwei Betten für die Überwinterungspersonal zur Verfügung stehen. Blau = Zu den Sozialräumen gehören Lounge, Messe, Küche, Wäscherei, Sauna, Sport, Toiletten, Waschräume und dafür notwendige Lagerräume. Rot/rotes Kreuz = Das Hospital wird in zwei Räumen eingerichtet. Rot = Die technischen Einrichtungen sind Kraftstation, Energiemanagement, Klimatisierung, hydraulische Steuereinheit, Werkstatt und Lagerräume. Grün = Arbeitsräume für den technischen Stationsbetrieb und Funktionskontrolle. Im Deck U1 befinden sich hauptsächlich Werkstätten und Lagerräume für die Verpflegung sowie technische Einrichtungen wie Schneeschmelze, Wasseraufbereitung, Kraftstoffpumpenraum, Hydraulikaggregate. Deck U2 ist die Garage für die Kettenfahrzeuge, die auch weiteren Raum für zusätzliches Staugut bietet (Any Motion/AWI).

ments of a small crew which is confined to a small place over prolonged times, and on the other hand with a larger group of people in summer. From the lounge (Deck 1), which is situated at the southern end of the building and takes its total width, one has a wide view into the icy landscape. There is also a small gymnastics room and a sauna, and the gallery reaching all around the inner building can be used for jogging.

Accommodation is for up to ten people during winter, and up to 20 guests plus changeover winter personnel during summer season. The winterers have single rooms, while the summer guests – depending on their numbers – have to accommodate with up to four persons in a room. All sleeping rooms, laboratories, working and living rooms except of the kitchen have windows. They cannot be opened, though, but they give daylight and provide views on the environment.

#### Power supply, energy management and technical equipment

Diesel engines will basically provide the necessary power supply. One separate engine will be installed for emergency cases. A sophisticated energy management and the inclusion of wind power will contribute to fuel efficiency and minimization of unwanted exhaust gas emissions.

All required heating energy for the building is to be provided by excess heat from the diesel engines through cooling water and exhaust gas heat exchangers. About 70 to 150 kW of heat will be needed in the station. The available heat energy will be even higher under most foreseeable conditions. Electrical heating may be necessary under rare conditions where very little electric demand, mostly provided by the wind generators, comes together with an extreme thermal power demand at the same time. Although it is difficult to see such conditions arise heater rods will be provided to the buffer tanks and heating circuits. The required energy will be gained from three diesel engines and one wind generator as one can see in the cogeneration scheme (Fig. 29).

The available electric power is 300 kW with two of three machines running plus max. 30 kW of wind power, thus safely covering the peak demand (still without load shedding) envisaged during summer. Two compact, paralleled Uninterrupted Power Supply systems (UPS) with a capacity of 20 kW/20 minutes each will provide a safe power supply for the extensive electronic data processing equipment.

The inclusion of wind power is an important segment of the energy management. The concept is to gradually increase the contribution of wind energy over the years. AWI has a long-term experience to operate a wind power plant at NM-II. It has been developed for the special Antarctic conditions. Since 1994 the test module worked reliably over the years and covered up to 10 % of the energy demand of the station (EL NAGGAR et al. 2000). Based on these positive experiences an advanced wind generator unit E-10 with 30 kW nominal power is currently under development in cooperation between ENERCON GmbH (Aurich, Germany) and AWI (Tab. 5). The design includes a lightweight supporting-structure for the foundation in snow, which can easily be moved to higher places before it is buried by accumulating snow. The first test module will be installed during the final assembly of the

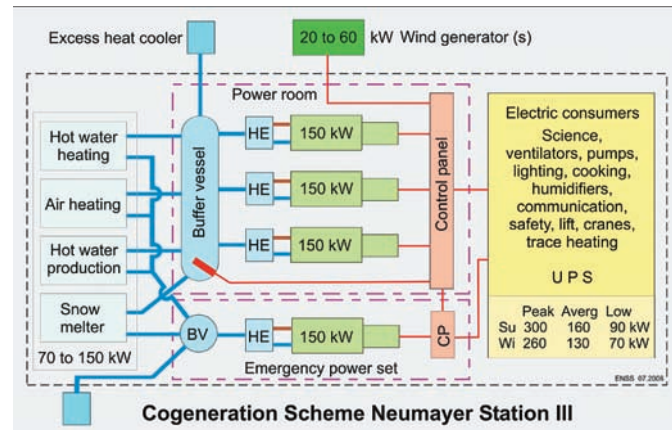

**Fig. 29:** Cogeneration scheme of power and heat supply for NM-III. The power plant consists of three diesel engines (150 kW each), one wind generator (30 kW) and one emergency power unit (150 kW). Each diesel engine provides 150 kW of electric energy and, depending on electric load, through heat exchanger 70 to 150 kW of heat energy. Consumers of electric energy (right side) and heat energy (left side) are shown. The estimated peak, average and low consumption of electric energy is shown for summer and winter conditions (right). The average demand of electric and heat energy (including snow melting) can be covered by one diesel engine (Enss pers. com. 2006).

**Abb. 29:** Diagramm für das Blockheizkraftwerk für NM-III. Die Kraftstation verfügt über drei Dieselmotoren (jeweils 150 kW), einen Windgenerator (30 kW) und einen Notstromgenerator (150 kW). Jeder Dieselmotor liefert 150 kW elektrische Energie und über die Wärmetauscher, in Abhängigkeit von der elektrischen Last, 70 bis 150 kW Wärmeenergie. Elektrische Verbraucher rechts, Verbraucher der Wärmeenergie links. Maximaler, mittlerer und minimaler Verbrauch elektrischer Energie für Sommer- und Winterbedingungen ist geschätzt (Su, Wi; rechts). Ein Dieselmotor allein kann den durchschnittlichen Kraft- und Wärmebedarf der Station – einschließlich der Schneeschmelze – decken (Enss pers. Mittel. 2006).

Item	Description
Total weight	2700 kg
Height up to hub	15 m
Length of fixed pitch blades	5 m
Yawing system	follows wind direction changes
Generator	direct propulsion without gear box
Operation range – wind speed	2 – 40 m s <sup>-1</sup>
Brakes	by electrical load
Nominal capacity	30 kW
Power limitation	stall control

**Tab. 5:** Design parameters for the lightweight wind generator E-10.

**Tab. 5:** Entwurfsparameter für den neuen Windgenerator E-10.

station in the austral summer 2008/2009. As mentioned above the share of wind energy will be increased stepwise by the installation of further wind generator units in the subsequent years. The aim is to significantly reduce the consumption within a period of five years below the current consumption of NM-II.

The Diesel engines at NM-III with four-stroke pump nozzle technology will come with a motor management system, which will ensure compliance with current European exhaust emission standards. In order to meet future standards and to further reduce emissions pre-installations are provided to use urea based technology at a later stage. The machines allow safe running with less than usual partial loads so that all feasible demand can be covered without excess power production. In that way it will be possible to use one size of motors throughout, quite useful in respect of maintenance and spares management. The estimated consumption of polar diesel will

be about 300 to 350 tons per year. This is approximately 150 tons more than currently needed for NM-II, mainly due to an increased power demand for an enlarged laboratory capacity, scientific outstations, and generally more space. But the advanced design of the building – in spite of above-ground construction – and the energy management lead to a lower specific energy consumption. The specific fuel consumption is about  $210 \text{ l m}^{-2} \text{ a}^{-1}$  for NM-II, while NM-III will require about  $190 \text{ l m}^{-2} \text{ a}^{-1}$  only, which is a reduction by approximately 10 %.

Fresh water will be produced in a 25 kW snow melting device driven by waste heat from the diesel engines. A state-of-the-art waste-water treatment plant will be used for the grey and black waters of the base, and grey water will be recycled to the water system for toilet flushing. So the average fresh water consumption will be brought down to less than 90 litres per day and person compared to around 120 litres at NM-II.

Fire protection is of great importance in an exposed environment with low humidity and lack of water. The station is therefore divided into various fire sections and equipped with a sophisticated fire detection system. An automatically activated water fog extinguishing system protects all vitally important and fire-endangered technical installations of the station. Smoke extraction systems will allow access to the seats of fire and make effective fire fighting easier for the well-trained station crew.

There are sufficient storage capacities for fuel supplies and provisions on the platform, so that replenishing from stocks kept in winter storage areas on the ice will be reduced to very few times. Large cold rooms will be installed for the storage of one-year supplies of cold and deep-freeze provisions, and the diesel fuel tanks can take an amount lasting for more than two months.

The technical operation of the base is largely unattended, monitored and run automatically by an integrated sensor system. Alarms are triggered if attention is necessary. Individual groups or components of the automatic systems can be switched off at any time by the technical staff and operations continued by manual control. A building monitoring system serves for the early identification of unwanted deformations and stress in the spacious, multi-storied building. Both monitoring and sensing systems can also be observed via satellite at AWI in Bremerhaven. Even remote control interventions can be carried out from there.

The hospital will have high-grade medical equipment. Intensive efforts are made at the AWI to introduce a telemedicine system at NM-III to allow online exchange of medical data and support from Germany. It can be assumed that the “remote emergency room” will become reality at Neumayer Station III.

For an overview the main basic data of the new Neumayer Station III are compiled in Table 6 according to the planning stage as of November 2006.

#### COMPREHENSIVE ENVIRONMENTAL EVALUATION (CEE) AND CONSTRUCTION IN ANTARCTICA

First information on the Neumayer III project was given to the international community at ATCM XXVII in Cape Town

(GERNANDT 2004). A draft Comprehensive Environmental Evaluation (CEE) was prepared by AWI for the proposed construction and operation of NM-III and removal of the present Station NM-II. The draft CEE was prepared in accordance with Annex I of the Protocol on Environmental Protection to the Antarctic Treaty. It was submitted as Draft CEE to the relevant national authority in Germany in December 2004 (ENSS et al. 2004). In 2005 the Draft CEE was circulated among the Consultative Parties to the Antarctic Treaty and discussed at ATCM XVIII and at CEP VIII in Stockholm (GERNANDT 2005).

The draft CEE documented that no harmful or lasting effects to the environment are to be expected by the performance of the project. This is because of improved environmental and energy management procedures, and the introduction of “state-of-the-art” technologies to reduce fossil fuel consumption, minimise waste, and recycle and re-use water. In addition, NM-III was designed for a much longer lifetime (25 to 30 years) than its predecessors GvN and NM-II, and to be capable of being easily decommissioned and removed after eventually shutdown. The draft CEE concluded that the global scientific importance and value to be gained by the construction and operation of NM-III and the continued operation of the research facility by AWI on the Ekström Ice Shelf outweighs the minor impact the station will have on the Antarctic environment and fully justifies the activity proceeding. The CEE has identified and evaluated potential impacts. The environmental footprints of the proposed activities are minor, and the initial environmental reference state will be regained only a few years after when NM-II has been decommissioned.

After consideration at CEP VIII the final CEE was published in 2006, and meanwhile the national permit for the activities has been given, valid for the construction works in Antarctica from June 2006 onwards until the year 2011, including the removal of NM-II.

On 8 January 2006 the inauguration of the selected construction site took place on the Ekström Ice Shelf. Representatives of the German Bundesministerium für Bildung und Forschung (BMBF), AWI, and guests from the Norwegian Polar Institute (NPI) as well as scientists and technicians working at NM-II participated in the event (Fig. 30).

The general planning and design of the new station was completed in November 2005 and the detailed engineering planning for manufacturing was completed until January 2007. Shipment to Antarctica has to be performed until the beginning of December 2007. The building moduls, site camp, construction plant and fuels, altogether some 3000 tons, will be brought to Antarctica by a chartered, ice-going ship, while the building personnel will travel by air coordinated by DROMLAN. Transports between ship’s landing places at the ice edge and the 21 km distant site (see Fig. 22) will be carried out by means of tracked vehicles and sledges, mostly belonging to the station’s plant pool. A site camp for about 45 persons will have to be set up before the construction works can start and will be removed after completion of building. The erection in Antarctica will take place during the austral summers 2007/08 and 2008/09, with the better part of the second season left for moving the scientific installations from NM-II to the new station NM-III.

Item	Description / data
Initial geographic position (at begin)	70°40.8' S, 008°16.2' W; Ekström Ice Shelf, Atka Bay
Ice shelf flow velocity	157 m per year in northerly direction
Distance to ship's landing place	21 km ("Landing Place North" at ice shelf edge)
Snow accumulation rate	80 cm per year
Horizontal snow deformation rates	1.5 mm per metre per year (strain and compression)
Design wind velocity	63 m s <sup>-1</sup> (227 km h <sup>-1</sup> = very severe storm)
Design temperatures	Max. +5 °C, min. -45 °C
Percent of days with drifting snow	60 %
Planned service life time of station	at least 25 years
Length / width of building	Garage 76 m / 26 m; platform 68 m / 24 m
Height of building	Garage floor 8.20 m below snow surface; platform hull from 6 m to 16.5 m above snow level; total building height 29.2 m including trench and balloon filling shed
Total weight of building	c. 2600 ton
Jacking equipment	16 hydraulic cylinders, 1.5 m stroke and 250 ton (360 ton short time) capacity each
Basic construction materials	Steel, light metal, timber, plastics; no CFCs containing insulation or auxiliary materials
Heated areas winter section	1850 m <sup>2</sup> (thereof 238 m <sup>2</sup> laboratories and laboratory-stores)
Heated areas summer section	172 m <sup>2</sup>
Cold areas on platform	548 m <sup>2</sup> (gallery, corridors and stairs)
Cold rooms	42 m <sup>2</sup> deep freeze room (-18°C); 42 m <sup>2</sup> cold room (+5 °C); coolant R134A / R404A
Usable areas snow ground in garage	1659 m <sup>2</sup>
Usable areas intermediate deck U1	645 m <sup>2</sup> (partly heated)
Total protected areas	4473 m <sup>2</sup>
Laboratories / observatories	Meteorology (with forecast room, balloon filling station), geophysics, air chemistry (with clean room lab), multipurpose labs, electronics workshop, lab stores. Outstations: air chemistry, seismics, magnetics, meteorology, infrasound, as well as hydroacoustics.
Station hospital	Every medical care below intensive care level possible; telemedicine system
Wintering staff	max. 10 persons; during exchange in summer season max 20 persons
Summer season personnel	max. 20 persons regular (12 more for short-time)
Power generation	Diesel generators 3 x 150 kW + 1 x 150 kW back-up, average demand 140 kW, 400/230V, 3 phase 50 Hz
Renewable energy	Wind generator 30 kW (option for extension)
Uninterrupted power supply (UPS)	Sealed batteries, 2 x 20 kW for 20 minutes
Fuels, storage / consumption	Polar Diesel; 6 x 9000 l tanks on the platform; c. 350000 l annual consumption (without vehicles, including 30 kW wind generator usage)
Electrical cables	All cables shielded; silicon jackets halogen-free, flame retardant
Fresh water demand	Less than 90 litres/person/day; usage of treated waste water for toilet flushing
Water generation	25 kW snow melter, use of excess heat only; 4 m <sup>3</sup> (summer 8 m <sup>3</sup> ) storage capacity
Hot water generation	Excess heat driven boiler (winter and summer)
Heating / ventilation	All heating by usage of excess heat of the diesel engines or of wind energy; air humidification c. 10 kW. Forced ventilation in the garage.
Fire protection	Water fog, carbon dioxide
Sewage treatment	Cleaning and disinfection of combined (grey/black) waste-waters and discharge to snow pit; direct collection facilities for dangerous liquids from labs.
Garbage treatment	Separate collection, compaction, complete removal (i.e. no combustion at the station)

**Tab. 6:** Basic data of Neumayer Station III (NM-III) according to planning stage as of November 2006 (Enss pers. com. 2006).

**Tab. 6:** Technische Daten der Neumayer-Station III (NM-III) entsprechend dem Planungsstand von November 2006 (Enss pers. Mittel. 2006).

When NM-III will take up operation all scientific and technical facilities of the geophysical observatory will be renewed and improved again. There will be a third generation observatory with new instruments and new data acquisition systems, and outside stations will be remotely controlled. Likewise, after 13 years of permanent operation, the present air chemistry observatory is to be replaced. New laboratory containers with advanced installations will be installed on a separate steel platform in parallel with the construction works during austral summer 2007/2008.

Moving from the old NM-II to the new station NM-III can only take place once the technical services of the new station are fully operational, so that there is the least possible interruption of scientific monitoring. This means that the removal of the NM-II, an imperative requirement of the Environmental Protocol, can only be started after NM-III is in full operation. According to the current planning these works are going to start during austral summer 2009/2010 earliest.





**Fig. 30:** Inauguration of the construction site of the new Neumayer Station III (NM-III) on 8 January 2006. Left to right: Reinhard Junker (Chair of AWI Board), Gry Larsen (Norwegian Ministry of Foreign Affairs), Aage Rosnes (Norwegian Ministry of Education and Research), Kjetil Bjorklund (Norwegian Ministry of the Environment), Jan Gunnar Winter (Director NPI), Hege Andenes (Norwegian Ministry of the Environment), Rainer Köttgen (Vice Chair of AWI Board), Jan Erling Haugland (Chair DROMLAN), Jörn Thiede (Director AWI), Hartwig Gernandt (Head AWI Logistics), Nikolaus Schües (F. Laeisz Shipping).

**Abb. 30:** Bauplatz-Einweihung für die neue Station Neumayer III (NM-III) am 8. Januar 2006. Von links nach rechts: Reinhard Junker (Vorsitz AWI-Kuratorium), Gry Larsen (Norwegian Ministry of Foreign Affairs), Aage Rosnes (Norwegian Ministry of Education and Research), Kjetil Bjorklund (Norwegian Ministry of the Environment), Jan Gunnar Winter (Director NPI), Hege Andenes (Norwegian Ministry of the Environment), Rainer Köttgen (Stellv. Vorsitz AWI-Kuratorium), Jan Erling Haugland (Chair DROMLAN), Jörn Thiede (Direktor AWI), Hartwig Gernandt (Leiter AWI Logistik), Nikolaus Schües (Reederei F. Laeisz).

## CONCLUSIONS

Germany will continue Antarctic research in its national frame as well as actively take part in international networks and projects. This effort, which needs a large share of field work and station facilities, is dependent on a very specific infrastructure allowing efficient and safe operations, and in turn requires regular investments to keep all facilities in top condition or to make advanced replacements.

Scientific and logistic activities are to be continued at the Ekström Ice Shelf and at Kohnen Station as part of the long-term scientific and political commitments to global networks and within the Antarctic Treaty System. This also includes to hold logistics at the disposal for new deep field traverses on the inland ice plateau and extended scientific aircraft missions in Antarctica.

The construction of the new station NM-III is one of the most ambitious projects of AWI during the International Polar Year (IPY). The construction works will be a major part of German

Antarctic activities during austral summers 2007/08 and 2008/09.

The construction site was carefully investigated. In 2009 the initial position of NM-III will be at  $70^{\circ}40.8'S$ ,  $008^{\circ}16.2'W$ . During the planned service lifetime NM-III will move about 4.5 km towards the present position of NM-II.

Due to the current demands of science and logistics as well as to meet future requirements the new station will provide more protected and more heated space than the present NM-II. A sophisticated energy management and the inclusion of wind power will contribute to reduced fuel consumption and minimization of unwanted exhaust gas emissions. Construction and operation will comply with the requirements and regulations of the Protocol on Environmental Protection to the Antarctic Treaty.

The continuation and extension of the scientific activities at NM-III and its important tasks as a logistic base justify the efforts to implement this innovative research station. The



**Fig. 31:** Artistic view of the new Neumayer Station III shallow founded in snow on Ekström Ice Shelf (courtesy of KAEFER Isoliertechnik GmbH & Co. KG).

**Abb. 31:** Künstlerische Darstellung der neuen Neumayer-Station III auf dem Ekström Schelfeis (mit freundlicher Genehmigung von KAEFER Isoliertechnik GmbH & Co. KG).

design is not only different from its predecessors but from all known buildings in Antarctica. It is keyed to prolong the lifetime of the facility so that renewal intervals get longer, and takes into account that all structures should remain accessible for dismantling and removal.

Several countries, including Germany, UK, United States, and France/Italy have recently completed or are busy building next generation stations. These will offer more comfortable conditions for living and science. The UK and Germany are facing tough challenges, because both stations will be built on moving ice shelves. To beat the encroaching ice, all new concepts apply the hydraulic jacking of the station buildings, which seems to become a standard feature in polar architecture of the future.

## ACKNOWLEDGMENTS

We greatly acknowledge the very successful cooperation with Dietrich Enss, Civil and Polar Engineering Consultant, Hamburg. He had been involved as designer and construction supervisor of the first two Neumayer Stations, and is currently working as a design adviser and planning coordinator for the Neumayer III project. He provided figures and tables as well as detailed information on the general and engineering design to the relevant chapters of this article. The Arbeitsgruppe Neumayer-Station III has been formed at AWI in 2002. This working group of scientists and engineers, lead by Dietrich Enss, developed the concept and provided advice during the initial design phase and planning works.

Initial engineering studies on the new concept were performed by Arbeitsgemeinschaft Boll & Partner Ingenieurgesellschaft mbH & Co KG / Scholzgruppe Ingenieure / Wulf & Ass. Architekten GmbH (Stuttgart). The General Design Works have been carried out by Arbeitsgemeinschaft IMS Ingenieurgesellschaft mbH (Hamburg) and m+p consulting Nord GmbH (Braunschweig).

Bernd Leitl, Merike Schultz, Tillmann Baur and Michael Schatzmann at Meteorologisches Institut, Zentrum für Meeres- und Klimaforschung, Universität Hamburg performed the aerodynamic studies. Wolfgang Rack and Martin Klenke (AWI) contributed satellite studies on ice shelf dynamics. GPS survey measurements were performed by Hans-Werner Schenke, Tobias Krömer, Daniel Schulte and Maik Weidt (AWI).

Very special thanks are due to Patrice Godon and his technical division from IPEV, France, as well to Karl Tuplin and his project group from BAS, UK, for helpful technical consultations.

Detailed engineering design, manufacturing and on site construction works are being carried out by Arbeitsgemeinschaft Neumayer III, J.H.K. Anlagenbau GmbH & Co KG/KAEFER Isoliertechnik GmbH & Co. KG (Bremerhaven). Visualizations based on the planning stage December 2006 were produced by AnyMotion (Bremen).

Thanks are due to Ralf Brauner (DWD) and Gerd König-Langlo (AWI) who have established the regular flight weather

forecast service for DROMLAN at Neumayer Station. The details, provided by Ralf Brauner to the relevant chapter of this article, are highly appreciated.

## Photo figures references

AWI archives	Fig.4; Figs. 6A, B, C; Fig. 7; Fig. 9; Fig. 10; Fig. 11; Fig. 12A; Fig. 18; Fig. 19A;
D. Enss	Fig. 3;
L. Kindermann	Fig. 8;
C. Drücker	Fig. 12B; Fig. 16; Fig. 16;
H. Gernandt	Fig. 2; Fig. 30.

## Acronyms and Abbreviations used

ALCI	Antarctic Logistics Center International
ARGE	Arbeitsgemeinschaft (Joint Venture)
ATCM	Antarctic Treaty Consultative Meeting
AUG	Ausführungssetz zum Umweltschutzprotokoll (Act of implementing the Protocol of Environmental Protection to the Antarctic Treaty of October 1991)
BAS	British Antarctic Survey
BGR	Bundesanstalt für Geowissenschaften und Rohstoffe
BHKW	Blockheizkraftwerk (cogeneration scheme)
BMBF	Bundesministerium für Bildung und Forschung
BSRN	Baseline Surface Radiation Network
CEE	Comprehensive Environmental Evaluation
COMNAP	Council of Managers of National Antarctic Programs
CTBT	Comprehensive Nuclear Test Ban Treaty
CTBTO	Comprehensive Test Ban Treaty Organization
DLR	Deutsches Luft- und Raumfahrtzentrum
DML	Dronning Maud Land
DROMLAN	Dronning Maud Land Air Network
DWD	Deutscher Wetterdienst
EPICA	European Project on Ice Coring in Antarctica
ECMWF	European Center of Medium Weather Forecast
GAW	Global Atmospheric Watch
GCOS	Global Climate Observing System
GPS	Global Positioning System
GTS	Global Telecommunication system
IAA	Instituto Antartico Argentino
IDC	International Data Center of the CTBTO
IGY	International Geophysical Year
IUPH	Institut für Umweltphysik Heidelberg
INACH	Instituto Antartico Chileno
IPEV	Institute Polair Emile Victor
IPY	International Polar Year
JARE	Japanese Antarctic Research Expedition
ASL	above sea level
NARE	Norwegian Antarctic Research Expedition
NDC	National Data Center at BGR
NDSC	Network for Detection of Stratospheric Change
NPI	Norwegian Polar Institute
PALAOA	PerenniAL Acoustic Observatory in the Antarctic Ocean
PB	Proportionality Boundary
SANAP	South African National Antarctic Program
SAR	Synthetic Aperture Radar
USP	Uninterrupted Power Supply unit
UVP	Umweltverträglichkeitsprüfung
UNA	International code for seismographic network stations
UVS	Umweltverträglichkeitsstudie
WMO	World Meteorological Organisation

## References

- Barr, W., Krause, R. & Pawlik, P.-M. (2004): Chukchi Sea, Southern Ocean, Kara Sea: the polar voyages of Captain Eduard Dallmann, whaler, trader, explorer 1830-96.- Polar Record 40 (212): 1-18.
- Betten, J. (2005): Creep mechanics.- Springer-Verlag, Berlin, 2nd Edition, 1-353.
- Boebel, O., Kindermann, L., Klinck, H., Bornemann, H., Plötz, J., Steinhage, D., Riedel, S. & Burkhardt, E. (2006): Real-time underwater sounds from the Southern Ocean.- EOS Transact. Amer. Geophys. Union 87/36: 361, 366.
- Bormann, P. & Fritzsche, D. (eds) (1995): The Schirmacher Oasis, Queen Maud Land, East Antarctica, and its surroundings.- Petermanns

- Geograph. Mitteil. Ergänzungsheft, 289: 1-448.
- COMNAP (2006): COMNAP Antarctic Facilities Map. Compiled for COMNAP by DataVision.- GIS Rty Ltd & Latitude Technologies Pty Ltd, <[www.comnap.aq/publications/maps](http://www.comnap.aq/publications/maps)>.
- DFG, Deutsche Forschungsgemeinschaft (2005): Deutsche Forschung in der Antarktis: Wissenschaftlicher Fortschritt und Perspektiven – Denkschrift.- M. Spindler, W. Arntz, G. Kleinschmidt, H. Oerter, A. Brandt, S. Faulhaber, J. Wohlenberg, F. Tessensohn & M. Huch (Hrsg.). WILEY-VCH Verlag, Weinheim, 1-211.
- Dörr, R. & Jessberger, H. (1983): Time-dependent deformation behaviour of structures in snow, firn or ice.- *Annals Glaciol.* 4: 47-51.
- Drücker, C., Wilhelms, F., Oerter, H., Frenzel, A., Gernandt, H. & Miller, H. (2002): Design, transport, construction, and operation of the summer base Kohlen for ice core drilling in Dronning Maud Land, Antarctica.- *Mem. National Inst. Polar Res. Spec. Issue* 56: 302-312.
- Eckstaller, A., Müller, Ch., Ceranna, L. & Hartmann, G. (2007): The Geophysical observatory at Neumayer stations (GvN and NM-II, Antarctica).- *Polarforschung* 76: xx-xx.
- El Naggar, S., Gernandt, H. & Janneck, J. (2000): Operational experience with wind power technology at Neumayer Station.- In: K. Shiraishi (ed), *Proc. 9th SCALOP Sympos.*, National Inst. Polar Res. Tokyo, 89-97.
- Enss, D. (1981): Die deutsche Antarktis-Forschungsstation.- *Hansa, Zentralorgan Schifffahrt, Schiffbau, Hafen* 13: 963-966, 1011-1015.
- Enss, D. (1981a): Die deutsche Antarktis-Forschungsstation.- *Hansa, Zentralorgan Schifffahrt, Schiffbau, Hafen* 15/16: 1165-1170.
- Enss, D. (1992): Der Neubau der Neumayer-Station in der Antarktis.- *Hansa, Zentralorgan Schifffahrt, Schiffbau, Hafen* 9: 877-892.
- Enss, D. (2000): Construction in Antarctica and cost effects on research after implementation of the Environmental Protocol.- In: K. Shiraishi (ed), *Proc. 9th SCALOP Sympos.*, National Inst. Polar Res. Tokyo, 13-24.
- Enss, D., Eckstaller, A., El Naggar, S., Gernandt, H., Janneck, J., König-Langlo, G., Oerter, H., Plötz, J., Ruholl, Ch. & Weller, R. (2004): Rebuild and operation of the wintering Station Neumayer III and retrogradation of present Neumayer II - comprehensive environmental evaluation (CEE). December 2004 / July 2005.- <[http://www.awi.de/infrastruktur/stationen/neumayer\\_station\\_III/umweltvertraeglichkeitsstudie/](http://www.awi.de/infrastruktur/stationen/neumayer_station_III/umweltvertraeglichkeitsstudie/)> <[http://www.awi.de/en//infrastruktur/neumayer\\_station\\_III/environmental\\_impact\\_study](http://www.awi.de/en//infrastruktur/neumayer_station_III/environmental_impact_study)>
- EPICA Community members (2006): One-to-one coupling of climate variability in Greenland and Antarctica.- *Nature* 444: 195-198.
- Fleischmann, K. (2005): Zu den Kältepolen der Erde – 50 Jahre deutsche Polarforschung.- *Delius Klasing, Bielefeld*, 126-140.
- Geduhn, M. & Enss, D. (2006): Bearing capacity of 20 single column shallow foundations of the Antarctic station Neumayer III over 30 years service life.- *Proc. OMAE2006, Pap. OMAE2006-92444*: 7.
- Gernandt, H. (1984): Erlebnis Antarktis.- *Transpress, VEB Verlag für Verkehrswesen, Berlin*, 1-284.
- Gernandt, H. (2004): Construction of a new permanent Antarctic station replacing Neumayer Station at Ekström Ice Shelf.- *Inform. Pap. (IP 028) ATCM 27, Cape Town*, <<http://www.ats.aq/>>
- Gernandt, H. (2005): Draft comprehensive environmental evaluation (CEE) – rebuild and operation of the wintering station Neumayer III and retrogradation of the present Neumayer Station II.- *Inform. Pap. (IP 030) ATCM 28, Stockholm*, <[http://www.ats.aq/#\\_Antarctic\\_Treaty\\_consultative](http://www.ats.aq/#_Antarctic_Treaty_consultative)>
- Kohlberg, E. & Janneck, J. (2007): Georg von Neumayer (GvN) and Neumayer (NM-II) stations – A Comparative Reflection of Technology and Living Conditions on two Antarctic Research Stations.- *Polarforschung* 76: xx-xx.
- König-Langlo, G. & Loose, B. (2007): The meteorological Observatory at Neumayer Station (Antarctica).- *Polarforschung* 76: 25-38.
- König-Langlo, G. & Gernandt, H. (2006): 20 Jahre Ozonsondierungen an den deutschen Antarktisstationen Georg Forster und Neumayer.- *Ozonbull. Deutsch. Wetterdienst*, 113: 2.
- Krause, R. (1992): Die Gründungsphase deutscher Polarforschung 1865-1875 – The period of founding of German Polar Research, 1865-1875.- *Rep. Polar Res.* 114: 1-375.
- Krause, R. (1993): Hintergründe der deutschen Polarforschung von den Anfängen bis Heute.- *Deutsch. Schifffahrtsarchiv* 16: 7-70.
- Krause, R. (1996): 1895: Gründungsjahr der deutschen Südpolarforschung.- *Deutsch. Schifffahrtsarchiv* 19: 141-162.
- Krause, R. (2001): Georg von Neumayer (1826-1909): Nestor der Meeres- und Polarforschung.- *Deutsch. Schifffahrtsarchiv* 24: 197-214.
- Krause, R. & Rack, U. (Hrsg) (2006): Schiffstagebuch der Steam-Bark GROENLAND geführt auf einer Fangreise in die Antarktis im Jahre 1873/ 1874 unter Leitung von Capitain Ed. Dallmann.- *Ber. Polar.-Meeresforsch.* 530: I-LXXV, 1-175.
- Lange, G. (Hrsg) (1996): Sonne, Sturm und weiße Finsternis – Die Chronik der ostdeutschen Polarforschung.- *Ernst Kabel Verlag, Hamburg, Schriften Deutsch. Schifffahrtsmuseums* 43: 124-130.
- Leitl, B., Schult, M. & Schatzmann, M. (2005): Windkanalversuche zur Schneewehen- und Kolkbildung im Umfeld der neuen deutschen Antarktisstation.- *Ergebnisber. Zentrum Meeres- & Klimaforsch. Univers. Hamburg*, 1-24.
- Leitl, B. & Schatzmann, M. (2005): Bestimmung der Windbeiwerte an der Antarktisstation Neumayer III.- *Abschlussber. Zentrum Meeres- & Klimaforschung, Universität Hamburg*, 1-62.
- Leitl, B., Schatzmann, M., Baur, T. & König-Langlo, G. (2006): Physical modelling of snow drift and wind pressure distribution at the proposed German Antarctic station Neumayer III.- *Proc. OMAE2006, pap. OMAE2006-92452*: 7.
- Reinke-Kunze, Ch. (1994): Alfred Wegener – Polarforscher und Entdecker der Kontinentaldrift.- *Birkhäuser Verlag, Basel*, 1-188.
- Schiermeier, Q. (2004): Cold comfort.- *Nature* 431: 734-735.
- Shapiro, L.H., Johnson, J.B. & Sturm, M. (1997): Snow Mechanics: review of the state of knowledge and applications.- *Report Nr. AD-A330 695, CRREL-97-3*: 1-40.
- Siegmund, R. (2004): AWI patent DE 103 58631.B3.
- Weller, R., Levin, I., Wagenbach, D. & Minikin, A. (2007): The air chemistry observatory at Neumayer Stations (GvN and NM-II, Antarctica).- *Polarforschung* 76: xx-xx.
- Wu, Z., Mahrenholtz, O. & Enss, D. (1993): Time dependent subsidence of snow-ground under distributed loading.- *Beitr. Mechanik, Festschr.* 65. Geburtstag Prof. Dr. Rudolf Trostel, *Tech. Univers. Hamburg-Harburg*, 170-179.