

Berichte

zur Polar-
und Meeresforschung

605
2010

Reports
on Polar and Marine Research



The Expedition of the Research Vessel "Polarstern"
to the Antarctic in 2003 (ANT-XXI/1)

Edited by
Otto Schrems
with contributions of the participants

 HELMHOLTZ
| GEMEINSCHAFT

ALFRED-WEGENER-INSTITUT FÜR
POLAR- UND MEERESFORSCHUNG
In der Helmholtz-Gemeinschaft
D-27570 BREMERHAVEN
Bundesrepublik Deutschland

ISSN 1866-3192

Hinweis

Die Berichte zur Polar- und Meeresforschung werden vom Alfred-Wegener-Institut für Polar- und Meeresforschung in Bremerhaven* in unregelmäßiger Abfolge herausgegeben.

Sie enthalten Beschreibungen und Ergebnisse der vom Institut (AWI) oder mit seiner Unterstützung durchgeführten Forschungsarbeiten in den Polargebieten und in den Meeren.

Es werden veröffentlicht:

- Expeditionsberichte (inkl. Stationslisten und Routenkarten)
- Expeditionsergebnisse (inkl. Dissertationen)
- wissenschaftliche Ergebnisse der Antarktis-Stationen und anderer Forschungs-Stationen des AWI
- Berichte wissenschaftlicher Tagungen

Die Beiträge geben nicht notwendigerweise die Auffassung des Instituts wieder.

Notice

The Reports on Polar and Marine Research are issued by the Alfred Wegener Institute for Polar and Marine Research in Bremerhaven*, Federal Republic of Germany. They appear in irregular intervals.

They contain descriptions and results of investigations in polar regions and in the seas either conducted by the Institute (AWI) or with its support.

The following items are published:

- expedition reports (incl. station lists and route maps)
- expedition results (incl. Ph.D. theses)
- scientific results of the Antarctic stations and of other AWI research stations
- reports on scientific meetings

The papers contained in the Reports do not necessarily reflect the opinion of the Institute.

The „Berichte zur Polar- und Meeresforschung“
continue the former „Berichte zur Polarforschung“

* Anschrift / Address

Alfred-Wegener-Institut
für Polar- und Meeresforschung
D-27570 Bremerhaven
Germany
www.awi.de

Editor in charge:
Dr. Horst Bornemann

Assistant editor:
Birgit Chiaventone

Die "Berichte zur Polar- und Meeresforschung" (ISSN 1866-3192) werden ab 2008 ausschließlich als Open-Access-Publikation herausgegeben (URL: <http://epic.awi.de>).

Since 2008 the "Reports on Polar and Marine Research" (ISSN 1866-3192) are only available as web based open-access-publications (URL: <http://epic.awi.de>)

The Expedition of the Research Vessel "Polarstern" to the Antarctic in 2003 (ANT-XXI/1)

**Edited by
Otto Schrems
with contributions of the participants**

**Please cite or link this item using the identifier
hdl:10013/epic.34025 or <http://hdl.handle.net/10013/epic.34025>**

ISSN 1866-3192

ANT-XXI/1

**22 October 2003 - 15 November 2003
Bremerhaven - Cape Town**

**Fahrtleiter / Chief Scientist
Otto Schrems**

**Koordinator / Coordinator
Hans-Otto Pörtner**

CONTENTS

1. Zusammenfassung und Fahrtverlauf	3
Summary and itinerary	5
2. Weather conditions	8
3. Atmospheric chemistry and satellite ground truthing	12
3.1 Measurements of ozone profiles with ECC sondes on a North (50°N) to South (30°S) transect	12
3.2 FTIR measurements of atmospheric trace gases for the validation of the SCIAMACHY instrument on board the ENVISAT satellite	14
3.3 Determination of aerosol optical depth by sunphotometer measurements	16
3.4 Measurements of aerosols and tropical cirrus clouds with an Aerosol Raman LIDAR	17
3.5 UV-B and UV-A spectral measurements and UV-B dosimetry	21
3.6 MAX-DOAS observation of tropospheric and stratospheric trace gases for validation of the SCIAMACHY instrument	25
3.7 Multiphase halogen chemistry in the Atlantic marine boundary layer	27
3.8 Global marine sources of reactive halogen species	29
3.9 Levels and patterns of organic nitrates in the northern and southern hemisphere	33
4. MARINE CHEMISTRY	35
4.1 ¹³ C-sampling programme during <i>Polarstern</i> transits	35

5. ACOUSTICS	37
5.1 Sea acceptance test of the Hydrosweep multibeam system in the Bay of Biscay	37
5.2 Sediment acoustics: Software replacement and data collection	44
A.1 Beteiligte Institute / Participating Institutes ANT-XXI/1	51
A.2 Fahrtteilnehmer / Participants ANT-XXI/1	53
A.3 Schiffspersonal / Ship's crew ANT-XXI/1	54
A. 4 Station list PS 28	55

1. ZUSAMMENFASSUNG UND FAHRTVERLAUF

Otto Schrems

Alfred-Wegener-Institut für Polar- und Meeresforschung



Nach einer knapp 10-tägigen Liegezeit in Bremerhaven nach der letzten Arktisexpedition legte die *Polarstern* am Mittwoch, den 22. Oktober 2003, wie vorgesehen pünktlich um 11.00 Uhr (MESZ) zum 1. Fahrtabschnitt ihrer 21. Reise in die Antarktis ab. An Bord des Schiffes waren 44 Besatzungsmitglieder sowie 28 Wissenschaftler aus Deutschland, Großbritannien und den USA. Schwerpunkte der Forschungsaktivitäten an Bord waren Messungen von atmosphärischen Spurengasen und Aerosolen in Troposphäre und Stratosphäre, die z. T. auch zur Validierung von Instrumenten auf dem Umweltsatelliten ENVISAT dienen. Ein weiterer Schwerpunkt war die Erprobung eines Fächerecholots. Der Aufbau der Experimente für die atmosphärenchemischen Untersuchungsprogramme hatte bereits eine Woche vor Auslaufen des Schiffes begonnen, so dass die meisten Probennahme- und Messsysteme schon zu Beginn der Fahrt einsatzfähig waren.

Die Reise führte zunächst über die Nordsee Richtung Ärmelkanal. Nach zwei Tagen Fahrt durch eine ruhige See bei sonnigem, aber sehr kühlem Wetter entlang der südünglischen Küste erreichten wir das Arbeitsgebiet für die Erprobung des Fächerecholots in der nördlichen Biskaya. Das Gebiet am Canyon de Noirmoutier dient seit fast 20 Jahren zur Kalibrierung und Erprobung der Fächerecholotanlage Hydrosweep, die während der Liegezeit in Bremerhaven technisch erweitert wurde. Die stark zerklüfteten Geländeformen des 45 km langen Canyons am französischen Kontinentalhang, der einen Tiefenbereich von 150 m bis 4200 m durchläuft, stellen höchste Anforderungen an die Leistungsfähigkeit der Hydrosweep-Anlage. Während einer 30-stündigen Kalibrierung wurde der Canyon und ein weiteres Testgebiet dann auf vorgegebenen Fahrtprofilen mit großer nautischer Präzision mehrfach durchfahren.

Die 20 Atmosphärenwissenschaftler an Bord bildeten ein internationales Team für ein globales Atmosphärenchemie-Programm und ergänzten sich mit ihren jeweiligen Untersuchungen. Die Messungen, die auf dem Fahrtabschnitt ANT-XXI/1 durchgeführt wurden, dienen der Untersuchung chemischer und dynamischer Prozesse in der Atmosphäre und zur Bestimmung der Verteilung zahlreicher atmosphärischer Spurenstoffe in der Süd- und Nordhemisphäre.

Die Probennahmesysteme für Spurengase und Aerosole der amerikanischen Gruppe von der University of New Hampshire & Mount Washington Observatory und der University of Virginia sowie der Teilnehmer von den englischen Universitäten York

und Manchester sowie der Universität Ulm waren auf dem Peildeck und dem Krähenest der *Polarstern* installiert. Die Luftproben wurden überwiegend durch kontinuierlich arbeitende Messsysteme beprobt. Gesammelte Aerosolproben wurden mit den entsprechenden Messinstrumenten in den Labors direkt an Bord analysiert.

Bei diesen Untersuchungen bildeten anorganische und organische Halogenverbindungen einen besonderen Schwerpunkt. Es wurden aber u.a. auch das bodennahe Ozon, Kohlenmonoxid und organische Nitrate gemessen. Zu den Messsystemen an Bord, die mit Hilfe des Sonnenlichtes arbeiteten, zählten ein MAX-DOAS-Spektrometer der Universität Heidelberg, das Sonnenphotometer des AWI zur Messung der aerosoloptischen Dicke und das von AWI und der Universität Bremen gemeinsam betriebene FTIR-Spektrometer. Ein UV-Spektralradiometer und ein Biometer des AWI registrierten kontinuierlich die solare UV-Strahlung. Auf dem Helideck des Schiffes befand sich ein Laborcontainer des AWI mit einem Lidarsystem mit dem Höhenprofile von Zirruswolken und entlang der westafrikanischen Küste die Höhenverteilung von Saharastaub gemessen wurden. Täglich wurde vom Helideck eine Ozonsonde gestartet, welche jeweils Ozonprofile bis in Höhen von ca. 34 km lieferte.

Am Donnerstag, den 30. Oktober wurden die Kanarischen Inseln erreicht und *Polarstern* ging für einen halben Tag vor Las Palmas auf Reede. Von einem Boot wurde zusätzliche Ausrüstung auf *Polarstern* übergesetzt, was bei den bis zu 3 m hohen Wellen nicht ganz ungefährlich war, aber mit größter Vorsicht erfolgreich durchgeführt werden konnte. Außerdem wurden 6 Wissenschaftler ausgebootet und zwei Fahrtteilnehmer wurden aufgenommen. Südlich der kanarischen Inseln wurden dann neben den Hydrosweep-Messungen auch Testmessungen mit dem Parasound-Echsounder DS-1 durchgeführt und es konnten Messdaten über ein Gebiet von ca. 2000 Seemeilen gewonnen werden.

Der insgesamt sehr erfolgreiche Fahrtabschnitt ANT-XXI/1 endete am 15. November 2003 morgens um 8.00 Uhr nach dem Festmachen der *Polarstern* im Hafen von Kapstadt.

SUMMARY AND ITINERARY

After about 10 lay days at Bremerhaven following the last expedition to the Arctic *Polarstern* started the first leg of her 21st voyage to Antarctica on Wednesday, 22 October at 11.00 a.m.. Aboard the ship were 44 crew members and 28 scientists from Germany, United Kingdom and the USA. The main focus of the research activities aboard were measurements of atmospheric trace gases and aerosols in the troposphere and stratosphere, which partly also served for validation of instruments aboard the ENVISAT satellite. A further focal point was the test of echosounder systems. Setting up all the experiments for the atmospheric investigations had started already a week prior to sailing. Thus, most sampling devices and measuring systems were ready to operate right at the beginning of the cruise.

At the beginning of the journey we firstly passed the North Sea towards the English Channel. After sailing through a quiet sea at sunny but cold weather along the southern part of the English coast we arrived in the northern part of the Bay of Biscay. The area at the Canyon de Noirmoutier has served for 20 years for the testing and calibration of the echosounder system. The Hydrosweep system was operated there for test and calibration purposes. The echosounder system had been technically upgraded during the lay days in Bremerhaven. The cliffy forms of the 45 km long canyon at the French continental slope, passing through a water depth of 150 m to 4.200 m requires great demands on the performance of the Hydrosweep system. During a 30 hour lasting calibration the canyon and a further testing area were crossed several times at given profiles with high nautical precision.

The 20 atmospheric scientists aboard complemented each other with their measurement programmes and formed an international team for global atmospheric chemistry studies. The measurements which were carried out during the ANT-XXI/1 cruise dealt with the investigation of chemical and dynamical processes in the atmosphere and the determination of the distribution of numerous atmospheric trace substances in the southern and northern hemisphere.

The sampling systems for trace gases and aerosols of the American group from the University of New Hampshire & Mount Washington Observatory and University of Virginia as well as the participants from the English Universities of York and Manchester and the University of Ulm were installed at the observation deck and at the "crow's nest" of the ship. The air samples had mainly been probed by continuously running measurement systems. Collected aerosol samples were analysed directly aboard the ship with appropriate instruments.

The atmospheric investigations were specially focused on inorganic and organic halogen compounds. However, in addition, near the surface ozone carbon monoxide and organic nitrates were also measured. Among the optical instruments which used

solar radiation were the MAX-DOAS spectrometer of the University of Heidelberg, AWI's sunphotometer for the measurement of the optical depth of the atmosphere and a FTIR spectrometer which was jointly operated by AWI and the University of Bremen. AWI's UV spectroradiometer and a biometer continuously registered solar UV radiation. A laboratory container was placed on the helicopter deck of the ship which contained AWI's LIDAR system MARL. This LIDAR was used for the study of height profiles of cirrus clouds and along the West African coast to study the height distribution of Saharan dust. From the helicopter deck an ozone sonde was launched daily. These sondes provide ozone profiles up to altitudes of 34 km.

On 30 October in the morning we arrived at the Canary Islands and lied in the roads at Las Palmas for half a day. Despite a rough sea a boat supplied *Polarstern* with additional equipment and 6 scientists disembarked and two scientists were taken aboard. In the further course, south of the Canary Islands test measurements not only with the Hydrosweep echosounder but also with the Parasound echosounder DS1 were performed yielding data over a distance of about 2,000 nm.

Altogether, the ANT-XXI/1 voyage was very successful and ended on 15 November 2003, at 8.00 a.m. after the mooring of *Polarstern* in the port of Cape Town.



Abb. 1.1: Fahrtverlauf von ANT-XXI/1
 Fig. 1.1: Cruise track of ANT-XXI/1

2. WEATHER CONDITIONS

Klaus Buldt
Deutscher Wetterdienst

RV *Polarstern* left Bremerhaven on time on 22 October 2003 at 11:00 h local time. A high pressure system reaching from Iceland to central Norway provided sunny but cool weather appropriate for autumn with easterly winds of 5 to 6 Bft. Only during the evening cloud fields of a shallow low pressure system at the western exit of the English Channel affected the conditions on our track. During the night it propagated to Brittany and later to central France. At its northern edge cold air was advected into our area. The orographic conditions in the English Channel induced an additional amplification of the easterly winds so that wind forces of 8 Bft were attained.

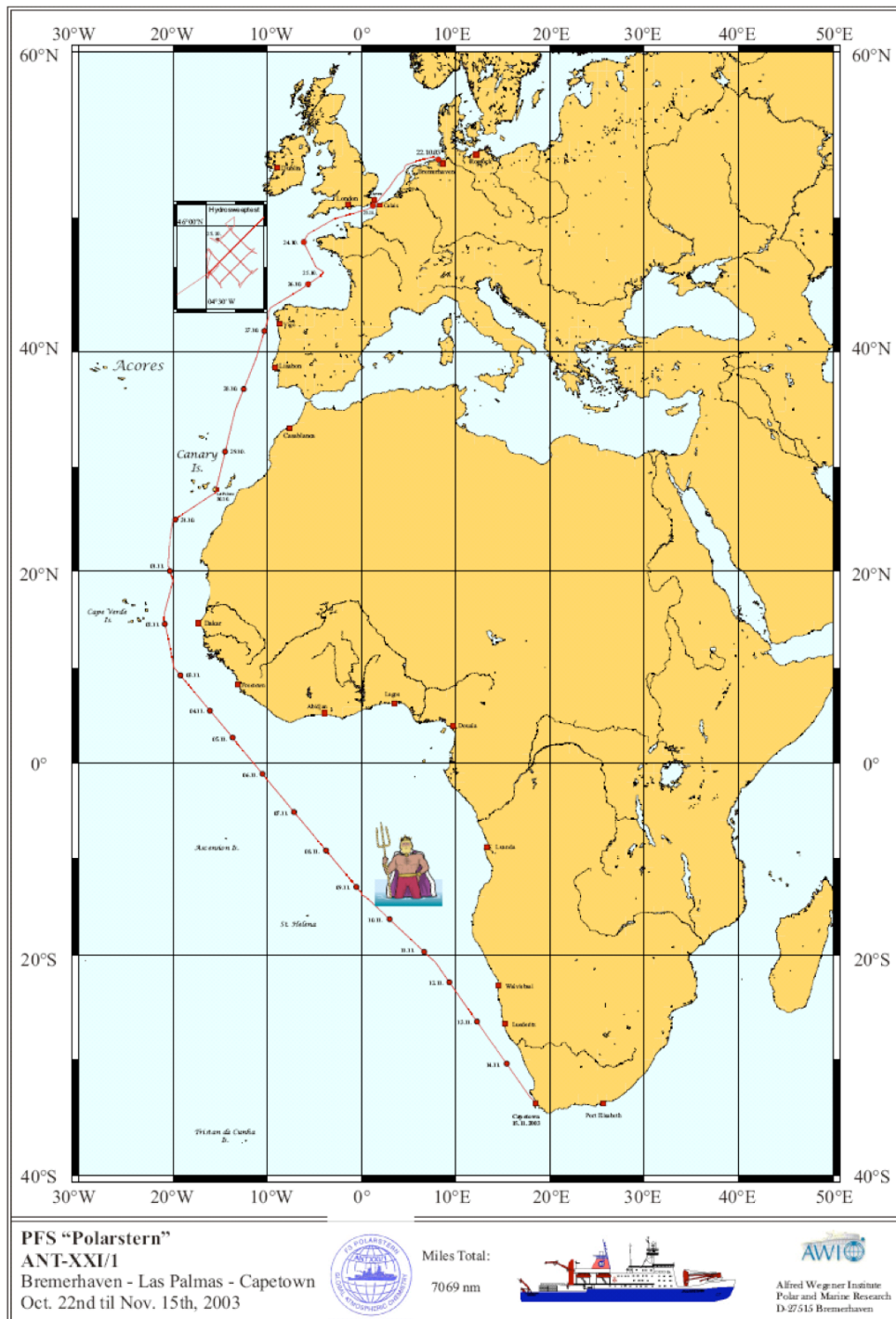
The stable high pressure system northwest of the Azores moved until 25 October only little to the east. Simultaneously a small but intensive low developed off the Portuguese coast. The area of the first operations of *Polarstern* was located between the two systems in the Bay of Biscay at 46°N 4°W. Here off-shore airflow from the east with wind forces of 3 to 4 Bft and only a few clouds provided optimal working conditions. The low changed its position and intensity only little during the following days. Along our track it gave rise to easterly to northeasterly winds on average of force 6.

In the early morning hours of the 27 October in the vicinity of Cape Finisterre the winds increased shortly up to 7 Bft. During the day the low shifted slightly to the northwest which induced a significant increase of the wind force and directions veering from southeast to south during the afternoon when the core with a pressure of 998 hPa was reached. Wind forces of 8 Bft and in gusts of 9 Bft were measured. Even in the evening the wind turning now to southwesterly directions relaxed only little.

On 28 October the low moved to southeast first (Fig. 2.1) and then again to east with unchanged core pressure. In consequence the track of *Polarstern* was situated during the whole day in the backside of the wind field with 8 Bft from southwest and with gusts of 9 - 10 Bft. The waves reached 4 m height. Only during the early evening hours the wind calmed slowly down and veered to westerly later to northwesterly directions.

On 29 October the low moved to southwest Portugal where it dissolved during the day. With easterly, later northeasterly winds of about 5 Bft, waves of 2 m and a few clouds *Polarstern* continued its course to Las Palmas.

On the early morning of the 30 October we reached Las Palmas. With northeasterly winds of 5 to 6 Bft and a swell of 2.5 m, heavy cloud cover and temperatures about 21°C, the transfer of personnel and material by boat lasted until the early afternoon. When we continued our cruise the wind increased due to local effects for a short time to 6 to 7 Bft before it calmed down completely in the lee side of the islands. On 31 October we left the area of the influence of the islands early and from now on the Northeast trade winds kept on with 4 Bft.

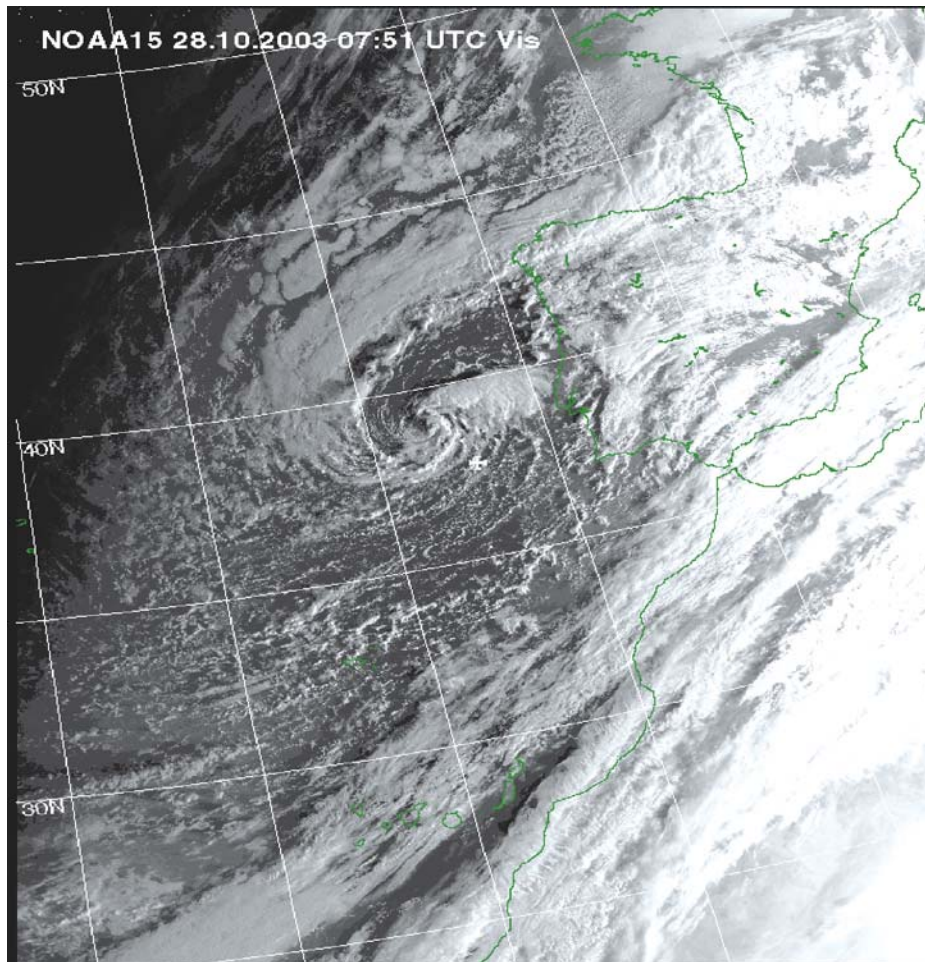

Fig. 2.1: The low pressure system off the Portuguese coast on 28 October 2003

In the early morning of the 3 November, almost exactly at 10°N, intensive lightning indicated the edge of the Intertropical Convergence Zone (Fig. 2.2). Already in the late morning we crossed the first tropical shower which provided up to 88 mm/h precipitation and a weak thunder storm. In the vicinity of the shower the wind reached 6 Bft. An intensive cloud cluster separated at 5°N 9°W from the West African coast during the afternoon and the evening and crossed our track in the night to 4 November. However they were not particular weather effective. During the day the over all weak to moderate winds veered to easterly directions and the cloud cover dissolved increasingly during the afternoon. At this day the highest temperatures during the whole cruise were measured with 28.6°C.

In the night from 5 to 6 November we crossed the Equator. The southerly wind blew with 4 to 5 Bft, the temperatures were about 25°C. During the following days we reached the area of influence of the South Atlantic subtropical high. At its northern edge extended fields of stratiform cloud cover determined the weather conditions. In consequence it was mostly cloudy in the morning but already in the early forenoon the clouds cover dispersed. The Southeast trades blew steadily with 4 to 5 Bft and the temperatures were at 24°C. There was no precipitation.

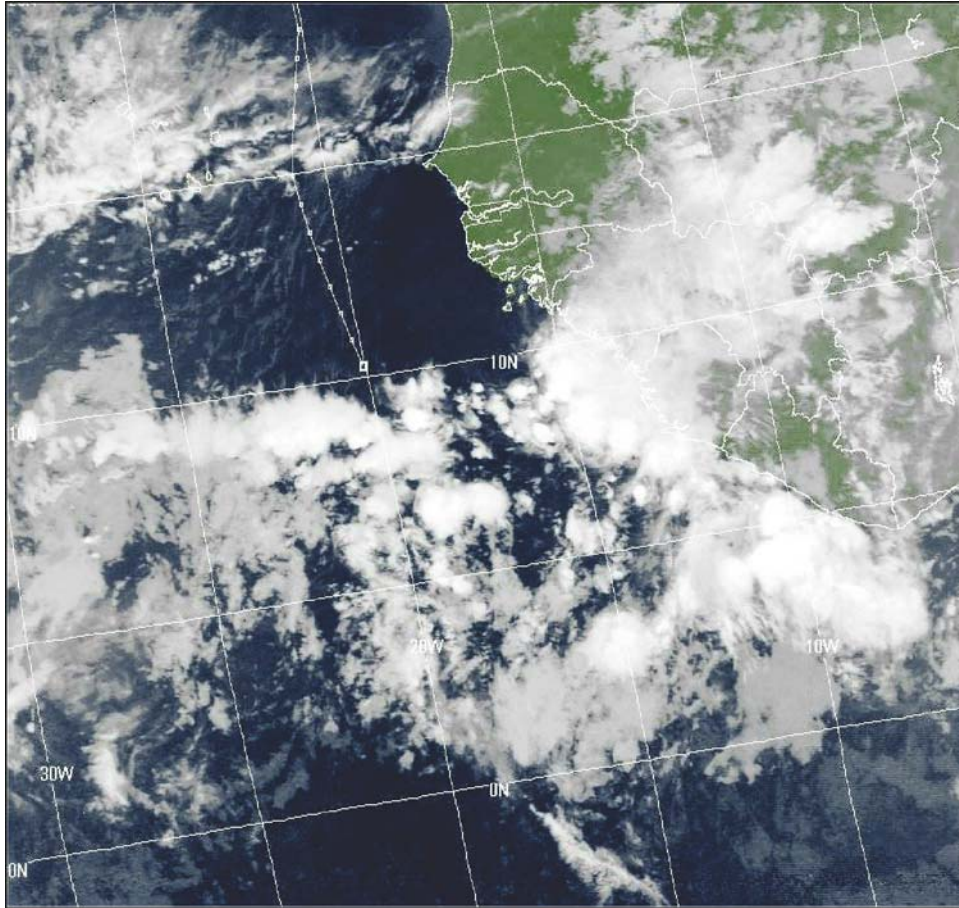

Fig. 2.2: Approaching the ITC early on 3 November at 10°N – 20°W

The subtropical high moving to the east and a stable weak low over Angola induced increasing gradients from the evening of the 10 November onwards. In consequence the wind increased to 6 to 7 Bft. The waves reached already 4 m in the morning of the 11 November.

On 12 November the situation did not change significantly. The subtropical high moved to the southern tip of Africa and over Botswana a further low developed which did not change its position at the beginning. On our course between the two pressure systems we experienced southeasterly to southerly air flow of 6 Bft, some clouds and waves of 4 m.

During the 13 November the wind relaxed again, but the sea calmed down only slowly. In the night to the 14 November the outskirts of a low centred at 51°S 2°E influenced the weather on our course with approaching high clouds. But already during the morning the last Cirrus fields had passed our course. With westerly winds of 4 to 5 Bft, a wave height of 2 m and temperatures around 18°C, this last day was one of the sunniest ones of the whole cruise.

Polarstern arrived in Cape Town in the morning of 15 November 2003 at 08.00 h local time. The distribution of wind direction and force during ANT-XXI/1 are presented in figs. 2.3 and 2.4.

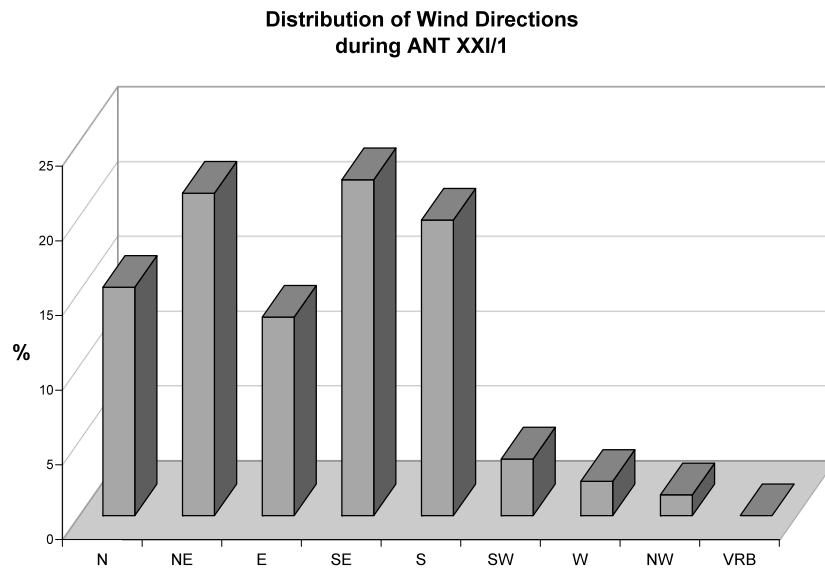

Fig. 2.3: Distribution of wind directions during ANT-XXI/1

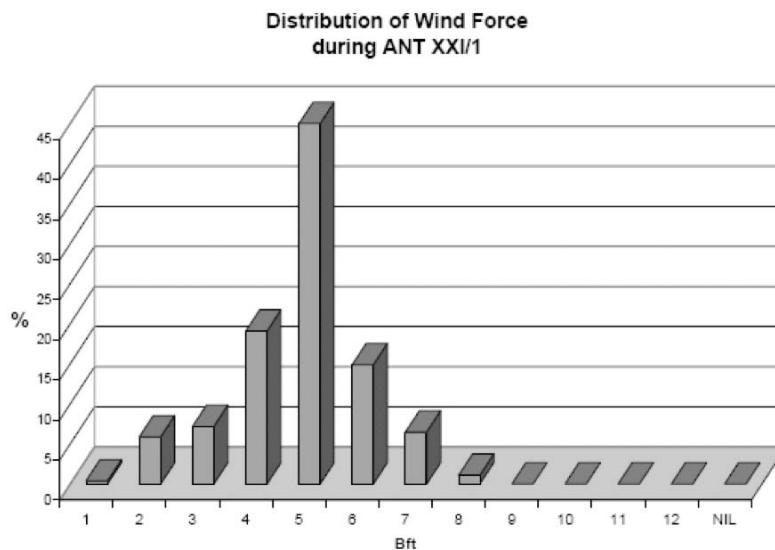

Fig. 2.4: Distribution of wind force during ANT-XXI/1

3. ATMOSPHERIC CHEMISTRY AND SATELLITE GROUND TRUTHING

3.1 Measurements of ozone profiles with ECC sondes on a North (50°N) to South (30°S) transect

Otto Schrems¹, Saad El Naggar¹,
Susann Tegtmeier¹, Ingo Beninga²

¹Alfred-Wegener-Institut
²Impres GmbH

Objectives

The main objective of this project was to study the vertical ozone distribution over the Atlantic Ocean by shipborne ozone soundings. We continued measurements performed during earlier ship cruises in order to obtain in combination with our previous soundings a comprehensive picture of the vertical ozone distribution pattern over a wide meridional range in the marine atmosphere over the Atlantic Ocean. Primarily, ozone data are available from vertical ozone profiles measured from ground stations which are either located in the continental northern hemisphere or in polar regions. However, there is still a lack of reliable ozone data from the subtropics and tropics. Thus, the intention of our measurements is to help closing this gap and to provide data for the calibration of satellite-borne instruments and for interpreting spectral UV measurements.

Work at sea

The ozone soundings aboard *Polarstern* were performed daily in the time period between 24 October 2003 and 14 November 2003. We used electrochemical concentration cells (ECC sondes) together with RS-80-GE and RS-90-AGE radiosondes from Vaisala. The sondes were launched with helium balloons from the helicopter deck of the ship. The balloons reached altitudes between 31 to 35 km, thus the maximum of the stratospheric ozone concentration is well documented. The ECC sondes were prepared according to the detailed instructions given by Komhyr (1986). The equipment allows to simultaneously measure the ECC current which corresponds to the O₃ partial pressure, the temperature of the inlet air, and from the meteorological sondes, atmospheric temperature, relative humidity, wind speed and direction, and the pressure of the ambient air. The data string has been modulated on a 403 MHz carrier frequency and transmitted to a DigiCORA radiosonde system (Vaisala) installed in the aerological lab of *Polarstern*. The demodulated signals have been fed into a PC for further evaluation by a special software (Vaisala): the data have been recorded in 10 s intervals. Taking into account the inherent time constant of the ECC sondes of approximately 20 s and the ascent velocity of around 5 m/s, the effective height resolution of the O₃ profiles is about 100 m.

Preliminary results

Altogether 22 ozone profiles were successfully recorded during the cruise. All dates of the ozone sonde launches along with the corresponding latitudes and longitudes and preliminary results for column densities are summarized in table 3.1.1. Figure 3.1.1 shows the preliminary results of the total ozone column. The total ozone column was changing between 350 DU in the North, decreasing in the subtropical and tropical regions and increasing again in the South to about 320 DU. The preliminary analysis of our measurements demonstrates, in connection with comparable data from previous measurements that shipborne ozone soundings are an adequate method to provide particulars of the general O₃ distribution pattern on a global scale.

Tab. 3.1.1 : Summary of all ozone sounding data collected during ANT-XXI/1 22.10.03 – 15.11.03

Date	Start Time [UTC]	Latitude [deg]	Longitude [deg]	Max.Height [m]	Ozone	Ozone	Ozone	Max. Sun Elevation [°]
					Measured [DU]	Residual [DU]	Total [DU]	
22.10.2003	-							
23.10.2003	-							
24.10.2003	09:42	48.88	-5.81	33023	268.8	34.7	304	30
25.10.2003	13:27	45.86	-4.38	31882	272.38	41.66	314	32
26.10.2003	13:39	45.17	-5.99	35033	307.38	34.95	342	32.4
27.10.2003	09:48	42.26	-10.7	34208	311.79	40.79	353	35.7
28.10.2003	21:42	35.09	-13.4	34385	297.8	39.29	337	40.1
29.10.2003	09:38	32.56	-14.14	32217	253.4	51.8	305	44.6
30.10.2003	16:21	27.78	-15.36	34760	250.35	40.63	291	47.1
31.10.2003	09:40	25.51	-19.18	31586	210	64	274	51
01.11.2003	16:00	18.91	-20.11	33770	254.7	53.5	308	56.2
02.11.2003	14:06	13.86	-20.81	32087	204.3	58.7	263	61.4
03.11.2003	09:30	9.74	-19.78	35036	226.3	40.8	267	66.1
04.11.2003	09:35	5.76	-16.44	31789	204.00	64.40	268	68.5
05.11.2003	09:41	2.61	-13.81	32981	223.7	52.31	276	70.9
06.11.2003	09:50	-0.98	-10.83	31189	240	95	335	72.5
07.11.2003	13:07	-5.43	-7.12	31326	226.40	75.80	302	79.2
08.11.2003	09:56	-8.68	-4.4	31208	207.3	71.5	279	82.4
09.11.2003	09:41	-12.49	-1.17	31651	234.2	82	316	86.1
10.11.2003	09:47	-16.08	2.49	32769	252.1	59.6	312	89.2
11.11.2003	09:43	-19.53	6.34	32752	248.6	60.7	309	87.5
12.11.2003	09:51	-22.52	9.15	31061	242.9	83	326	84.8
13.11.2003	09:47	-26.5	12.2	31963	259.5	65.8	325	81.1
14.11.2003	09:39	-30.9	15.73	33020	257	50	307	77
15.11.2003	-							

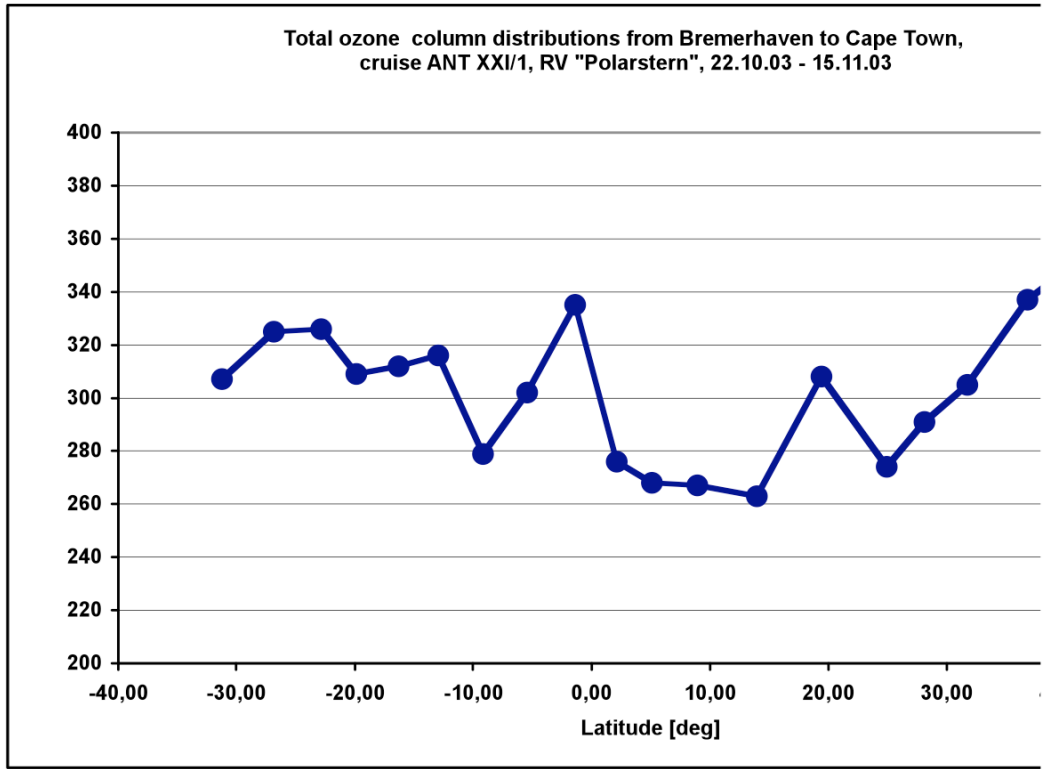

Fig. 3.1.1: Ozone column distribution between Bremerhaven and Cape Town during ANT-XXI/1

References

Weller, R., Lilischkis, R., Schrems, O., Neuber, R., Wessel, S. (1996) "Vertical Ozone distribution in the marine atmosphere over the central Atlantic Ocean (56°S - 50°N)", *J. Geophys. Res.*, 101, D1, 1387-1399.

Komhyr, W.D., Operations handbook - Ozone measurements to 40 km altitude with model 4A-ECC-ozone sondes, /NOAA Techn. Memorandum ERL-ARL-149/, *1986*.

3.2 FTIR measurements of atmospheric trace gases for the validation of the SCIAMACHY instrument on board the ENVISAT satellite

Astrid Schulz¹), Otto Schrems¹),
Thorsten Warneke²)
not on board: Justus Notholt,
University of Bremen

¹)Alfred -Wegener -Institut
²)University of Bremen

Objectives

The upper troposphere in the tropical regions act as a reservoir for gases entering the stratosphere, and the UTLS region (Upper Troposphere, Lower Stratosphere) is therefore of high interest for stratospheric research. Our previous ship-based measurements in this region have implied that trace gases originating from biomass burning in the African and the South American continents were enhanced in the upper tropical troposphere. It is thus likely that biomass burning has an influence on

the stratospheric air composition. Data of selected trace gases will also be used for the validation of the SCIAMACHY instrument on the ENVISAT satellite.

Work at sea

Measurements of atmospheric trace gases were conducted aboard the research vessel *Polarstern* during its cruise from Bremerhaven, Germany, to Cape Town, South Africa (ANT-XXI/1). This was accomplished using a Fourier Transform Infrared (FTIR) spectrometer which is mounted inside a custom-made laboratory container and which was located on the observation deck of the ship. Absorption spectra with a maximum resolution of 0.005 cm^{-1} were recorded by using the sun as light source. However, to record such high resolution spectra, very stable weather conditions are necessary. On 15 days of the cruise the conditions were good enough to perform such measurements. The respective days are indicated in table 3.2.1 below. Measurements during the other days were prevented by dense cloud fields, too high windspeeds or rough sea.

Tab. 3.2.1: Summary of measurement days, latitude of the measurements and expected data quality

Date	Approx. Latitude	Expected Data Quality
22.10.2003	53 N	low
24.10.2003	48 N	high
25.10.2003	45 N	high
29.10.2003	32 N	high
30.10.2003	29 N	high
31.10.2003	24 N	low
01.11.2003	20 N	high
02.11.2003	13 N	low
04.11.2003	5 N	high
05.11.2003	2 N	high
06.11.2003	0	high
07.11.2003	4 S	high
08.11.2003	8 S	high
10.11.2003	16 S	low
13.11.2003	26 S	high

Status of data and expected results

With the high number of measurements in the tropical regions obtained during this cruise, we were looking forward to providing new insights to the composition of the tropical free troposphere.

Data analysis will be performed after the cruise. Total column densities of more than 20 trace gases, including O_3 , HCl , HF , CH_4 , HCO_3 , NO_2 , CO , CO_2 , C_2H_2 , C_2H_6 , CH_2O , HCN and OCS will be retrieved from the gathered measurements. In addition, it will be possible to retrieve height-resolved information from high-resolution spectra

for some trace gases. This would yield concentration profiles with a resolution of 6-8 km.

Data of selected trace gases (e.g. CO, O₃, NO₂) will be used for the validation of the SCIAMACHY instrument on the ENVISAT satellite. The measurements in the tropical regions are of special interest for the validation since there are only very few measuring sites at these latitudes. The collected data will also be interpreted in comparison with cruise data obtained in October 1996 (Bremerhaven - Punta Quilla) and December 1999 (Bremerhaven - Cape Town), as well as with the data of two recent cruises between Cape Town and Bremerhaven in November 2002 and February 2003, during which the measurements in the tropics were also a major focus of the investigations.

References

Notholt, J., G. C. Toon, C. P. Rinsland, N.S. Pougatchev, N.B. Jones, B. J. Connor, R. Weller, M. Gautrois, and O. Schrems, (2000). Latitudinal variations of trace gas concentrations in the free troposphere measured by solar absorption spectroscopy during a ship cruise, *J. Geophys. Res.*, 105, 1337-1349

3.3 Determination of aerosol optical depth by sunphotometer measurements

Susann Tegtmeier, Otto Schrems
Alfred-Wegener-Institut

not on board: Andreas Herber, Alfred-Wegener-Institut

Objectives

The primary goal of the sunphotometer measurements is the determination of a meridional distribution of atmospheric aerosol. The values of the aerosol optical depth will be used for the evaluation of the UV irradiation measurements.

Work at sea

In this study, a multi-channel spectroradiometer SP1A developed by Dr. Schulz and Partner GmbH in Buckow, Germany, was used aboard *Polarstern* for the optical depth measurements. This instrument measures the sun intensity at 17 predetermined wavelengths in a range from 350 nm to 1,100 nm. It takes into account the changing sun elevation and the absorbing and scattering effect from non-aerosol particles, thus enabling it to yield optical properties of atmospheric aerosols, among them the aerosol optical depth.

Tab. 3.3.1: Summary of measurement days, geographical positions of the measurements and number of sunphotometer measurements

Date	Geographical position	Number of measurements
22.10.2003	53 N, 7 E	2
24.10.2003	48 N, 5 W	86
25.10.2003	45 N, 4 W	70
29.10.2003	32 N, 14 W	57
30.10.2003	28 N, 21 W	19
31.10.2003	24 N, 20 W	28
01.11.2003	20 N, 20 W	51
02.11.2003	13 N, 20 W	34
04.11.2003	05 N, 15 W	28
05.11.2003	02 N, 13 W	12
06.11.2003	01 S, 10 W	54
07.11.2003	04 S, 07 W	10
08.11.2003	09 S, 03 W	8
09.11.2003	13 S, 00 W	13
10.11.2003	15 S, 02 E	36

The sunphotometer measurements strongly depend on weather conditions. For the realization of a successful measurement a clear, cloudless sky, especially close to the sun, is needed. Sunphotometer measurements could be performed on 15 days. During the remaining days it was either too cloudy or too stormy for performing measurements.

After the calibration of the instrument in February, 2004, at Izana/Tenerife, Spain, it will be possible to calculate the aerosol optical depth from the measured voltage signals.

3.4 Measurements of aerosols and tropical cirrus clouds with an Aerosol Raman LIDAR

Franz Immler¹⁾, Otto Schrems¹⁾, Ingo Beninga²⁾

¹⁾Alfred-Wegener-Institut

²⁾Impres GmbH

Objectives

One of the main objectives of this activity was to determine the latitudinal variation of aerosol in the troposphere. Another focus of the project was the detection of tropical cirrus clouds. These clouds form in the tropical tropopause region at altitudes up to 18 km and are generally not visible by the bare eye. Tropical cirrus (TC) play an important role in the exchange between troposphere and stratosphere. As the air moves upward in the tropical tropopause region, these clouds stop the water vapour before it can enter the stratosphere, allowing only very small amounts to reach the stratosphere above 18 km.

Work at sea

The measurements were performed with our Mobile Aerosol Raman LIDAR system (MARL) which is mounted in a standard 20 ft laboratory container. During the cruise this container was placed at the helicopter deck of *Polarstern*. MARL is a backscatter LIDAR based on a linear polarized Nd:YAG Laser with 30 Hz repetition rate and 200 mJ pulse energy at 532 nm and 355 nm. The 9-channel detector measures elastic backscatter at 355 and 532 nm separated for polarization. Additional N₂-Raman channels at 397 and 607 nm provide the opportunity to perform extinction measurements. The system was generally operated with a time resolution of 140 s and a height resolution of 7.5 m. A small field of view and narrowband optical filters allow daytime operation.

Preliminary results

Data from about 100 hours of measurements could be collected during the cruise by this Mobile Aerosol Raman LIDAR. Dust from the Sahara and other continental sources is often present above the Atlantic in an altitude range from 2 to 6 km. During this cruise, however, we could only detect small amounts of Saharan dust. The highest dust loading was detected on 3 November at about 10°N where the optical depth reached values of about 0.2. Dust is identified by its scattering behaviour, in particular because it depolarises the linearly polarised laser beam. This can be detected with high sensitivity by the LIDAR (see Fig. 3.4.1). Interestingly, weak depolarising layers were present in the altitude range from 2 to 4 km starting from 4 November throughout the ITCZ region and south of the Equator down to about 16°S. The origin of this aerosol needs to be determined back home by means of backward trajectories.

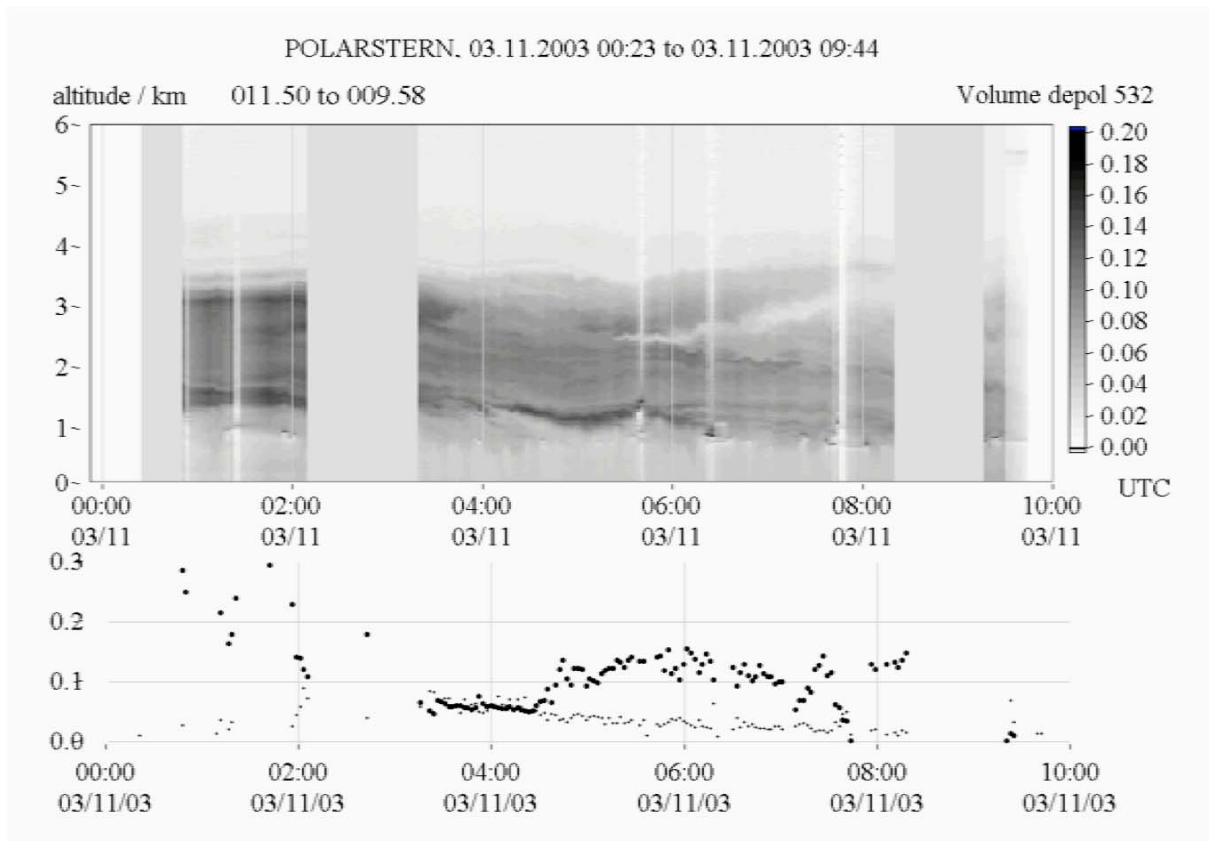

Fig. 3.4.1: These time series of the depolarisation profiles show a layer of Saharan dust in an altitude range between 1.5 and about 4 km. The lower plot gives the optical depth of the layer (dots) and the mean depolarisation (crosses). These measurements were made between 11.5 and 9.6°N (preliminary data).

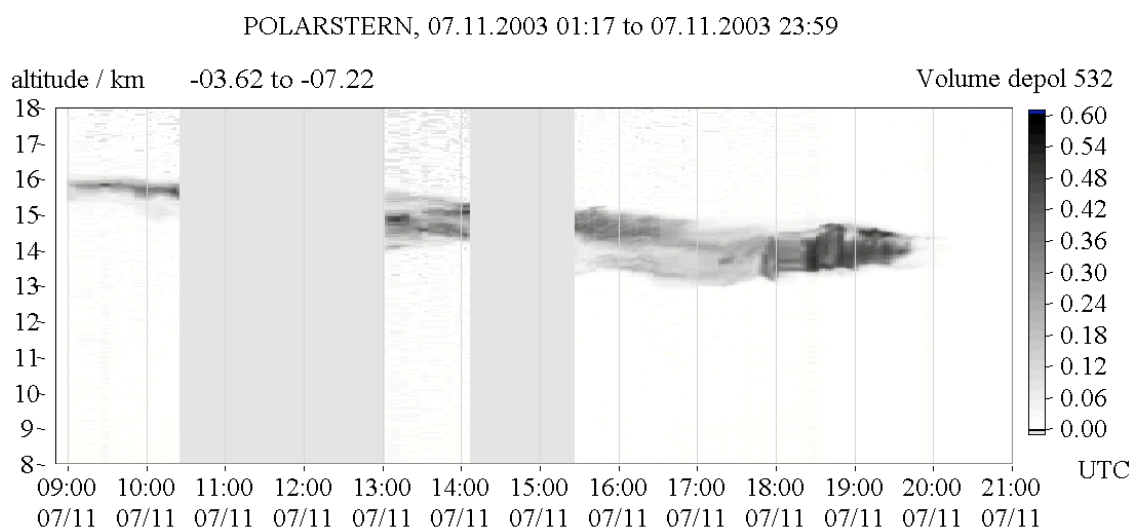

Fig. 3.4.2: Time series of depolarisation profiles measured aboard Polarstern on 7 November around 4°S. The series shows the occurrence of subvisible tropical cirrus throughout the day. Just about sunset (18:00 UTC) a stronger, visible cloud developed before the event disappeared. (preliminary data)

3.4. Measurements of aerosols and tropical cirrus clouds with an Aerosol Raman Lidar

As mentioned above a further focus of the project was the detection of tropical cirrus clouds. During this cruise we observed these types of clouds occasionally (see Fig. 3.4.2). The first event was registered on 1 November, 23:00 UTC, 17°N at 14 km altitude and the last one as far south as 14°S. That last one was of the ultra-thin type which describes clouds with an optical depth below 10^{-3} . In between there were some high altitude clouds detected in the ITCZ but there was also a large region without the occurrence of TC around the equator. In addition to the daily radiosounding at about noon time we had additional radiosonde launches at night, allowing for a detailed analysis of the temperature in the tropopause region. Based on this data we will be able to determine precisely the conditions under which tropical cirrus do or do not occur.

Based on Raman shifted backscatter, our LIDAR system is also able to determine the water vapour content in the lower and middle troposphere. These data are very useful to study the properties of aerosol in that region as it varies with the relative humidity. Also it gives an interesting insight in synoptic scale airmass variations. On 30 October a thin layer of very dry air was detected just above the planetary boundary (Fig. 3.4.3).

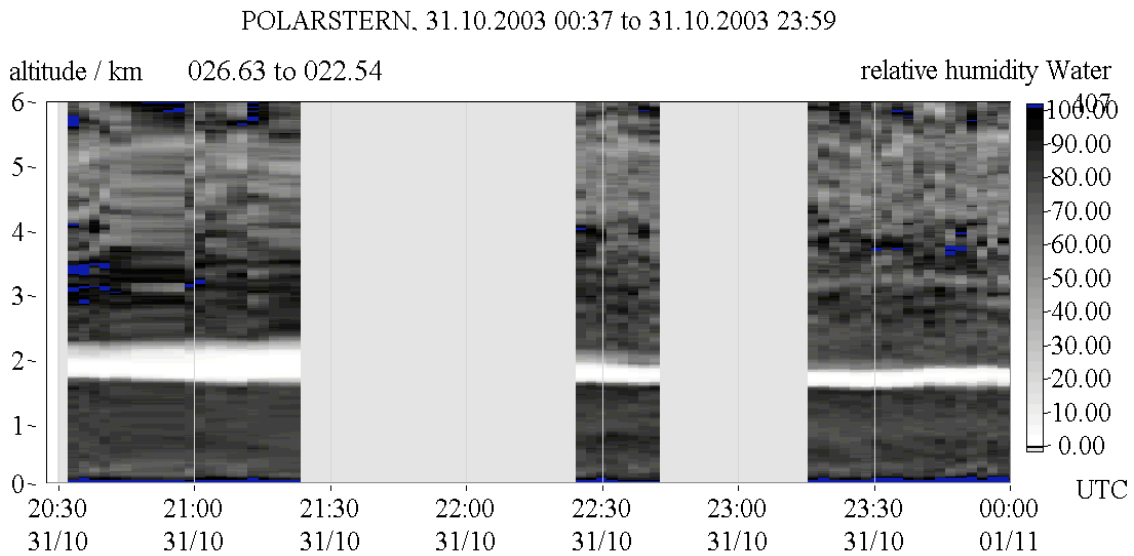

Fig. 3.4.3: Relative humidity calculated from water vapour Raman measurements by MARL (preliminary data)

3.5 UV-B and UV-A spectral measurements and UV-B dosimetry

Saad El Naggar¹⁾, Otto Schrems¹⁾, Heiko Lilienthal²⁾ ¹⁾Alfred-Wegener-Institut
²⁾ISITEC, Bremerhaven

Objectives

The aims of this project were to investigate incident UV radiation in dependence of latitude with the focus on the influence of variable ozone content in the atmosphere. In detail the following objectives have been addressed:

- measuring spectral UV-A and UV-B distributions during the cruise using our combined UV-A & UV-B spectroradiometer
- assessing different UV radiation conditions in a variety of climate zones and a large range of solar zenith angles.
- Correlation of meridional ozone column variations with UV-B irradiation
- Determination of global UV-B doses as a function of latitude, sun elevation and total ozone column with different radiation detectors.

Instruments

Solar spectral UV irradiance has been recorded with a spectroradiometer designed and built at AWI (Groß et al., 2001) This instrument consists of a Bentham 150 DTM double monochromator with a 32 Multi Channel Photomultiplier Plate to measure UV-B irradiance from 290 to 320 nm. The single channels of the UV-B instrument are 1.35 nm apart and the resolution is about 2 nm. For the detection of UV-A irradiance (320 to 400 nm) an Oriel single monochromator with a 256 diode array detector is used. The spectroradiometer has a resolution of 2 nm, but the channels have a step width of only 0.65 nm. Both, the UV-B and UV-A parts of the instrument are operated in a temperature-stabilized box and are controlled by the same software. A complete spectrum is obtained for each part every few seconds (1 sec for the UV-B, 2 to 32 seconds in the UV-A, depending on brightness). Spectra of UV irradiance are stored every minute.

Erythemal irradiance was recorded by two different types of instruments, the personal UV-B dosimeter ELUV-14 and the Solar Light Model 501 Biometer. Both instruments are broadband detectors with a response similar to the erythemal action spectrum. Data are stored in daily files in 1 minute and 5 minute records for the ELUV dosimeters and the Biometer, respectively.

Work at sea

The spectroradiometer for the measurement of the solar UV irradiance was mounted at the port side of the observation deck. The instrument was in operation during the whole cruise from 22 October to 14 November and had never failed (Tab. 3.5.1). For direct measurements of the erythemal weighted UV-B irradiances and doses, the UV-B- Biometer, type 501 from Solar Light was used and installed nearby the spectrometer.

Preliminary results

Fig. 3.5.1 shows the irradiance spectra of the UV-B integrated from 280 to 315 nm given with a time resolution of 5 minutes. When the ship crossed the meridian with the sun in the zenith on 10 November the expected maximum was influenced by cloud cover. The irradiance values in the figure obviously are influenced by three parameters, which are the solar zenith angle, cloud cover and ozone.

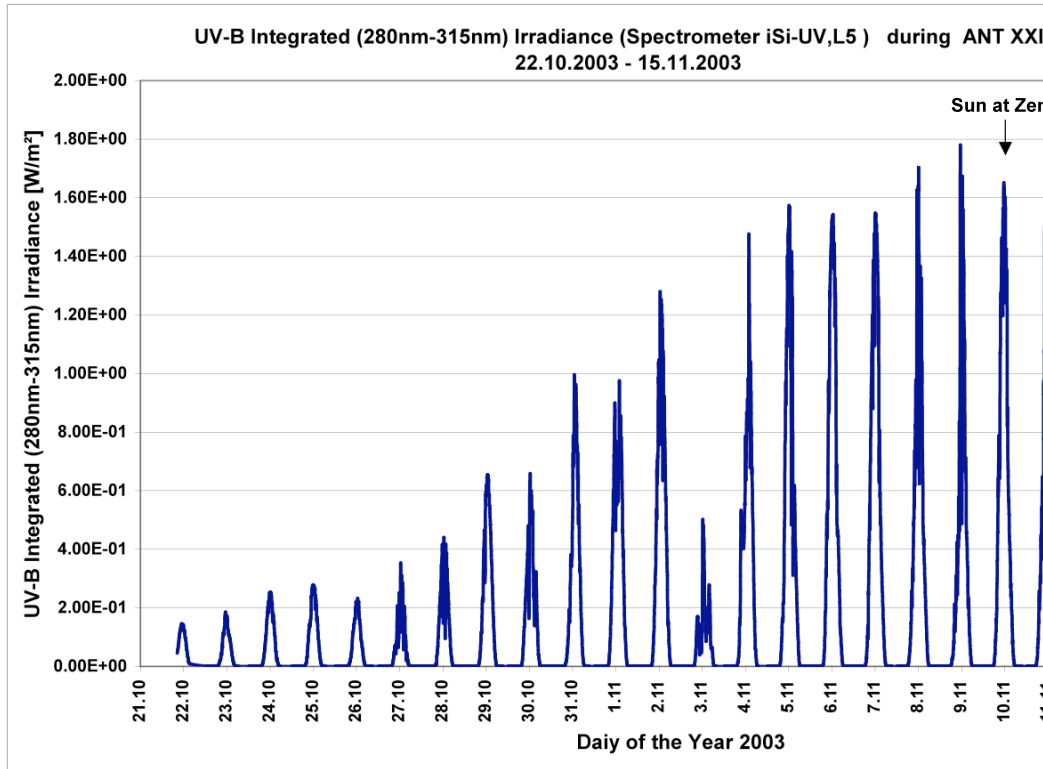

Fig. 3.5.1: Daily integrated UV-B irradiance during ANT-XXI/1

The integrated UVB doses retrieved from the integral over a whole day for wavelength between 280 and 315 nm, are shown in Fig. 3.5.2. The influence of cloud cover can be excluded by forming the ratio of two irradiance values of the same spectrum because the absorption of clouds is almost the same for two wavelengths not far separated from each other. The ratio obtained from the irradiance at 300 and 320 nm is called the UVB index. The index is only affected by the solar zenith angle and the ozone column, because the ozone absorption at 300 nm is rather high compared to that at 320 nm.

To calculate the relative ozone variations, the ratio of irradiance at 320/ irradiance at 300 is considered at the same zenith angel for every day. This is shown in Fig. 3.5.3 for airmass 2.3 which corresponds to a solar zenith angle of about 65 degrees. This airmass was chosen with respect to the departure date in Bremerhaven. This also means that for all other days of the cruise we obtained two index values, one in the morning and one in the afternoon. Note, that between both values at a position close to the equator the time gap between both measurements can be more than 8 hours. The average of both measurements is transformed on an absolute scale like in

Fig. 3.5.4. The absolute scale was derived from ozone sonde measurements at the same date. These total ozone values computed by an integral of the tropospheric and stratospheric ozone profile are also shown in figure 3.5.3.

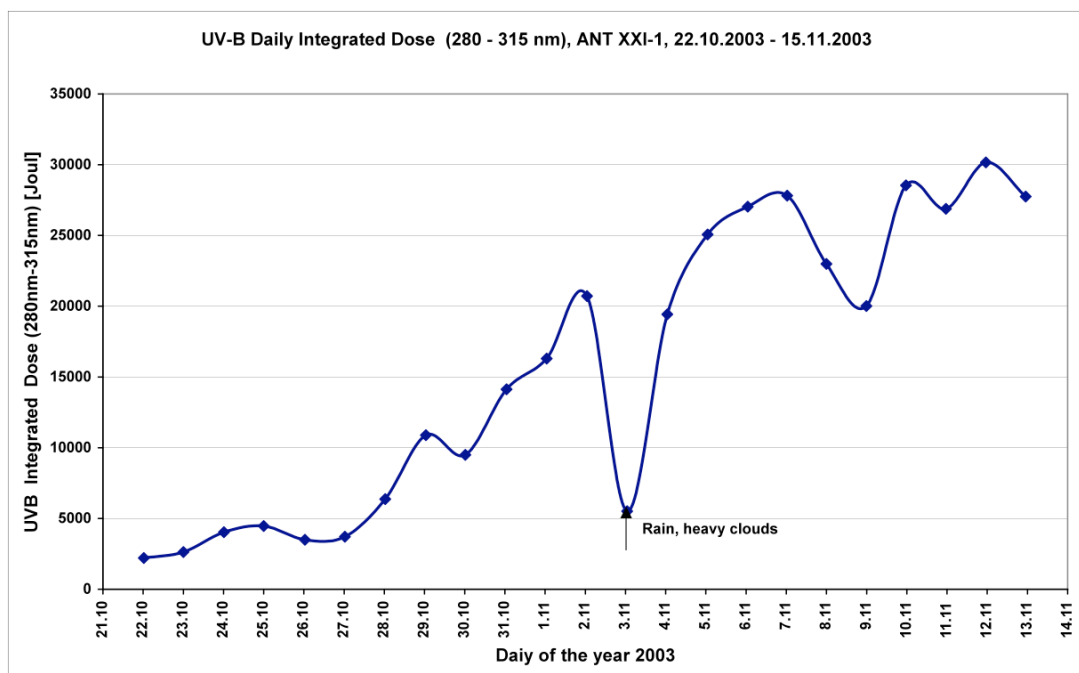

Fig. 3.5.2: Daily integrated UV-B dose during ANT-XXI/1

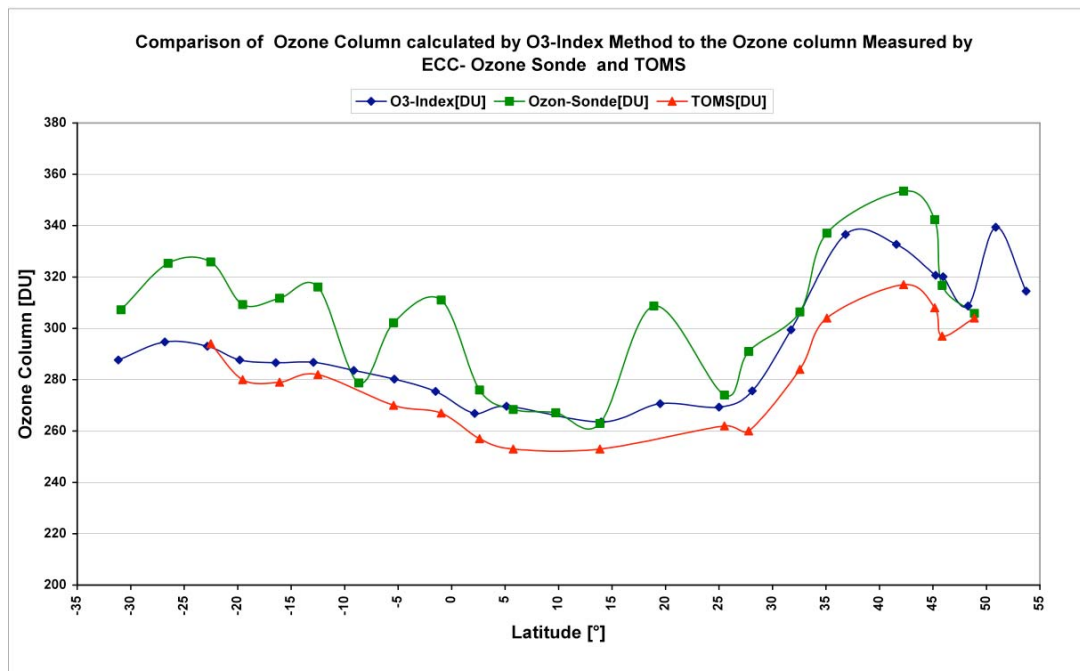

Fig. 3.5.3: Comparison of Ozone Column calculated by O₃-Index Method to the Ozone column measured by ECC- Ozone Sondes and TOMS during ANT-XXI/1

3.5 UV-B and UV-A spectral measurements and UV-B dosimetry

Figure 3.5.4 shows the UV-B unweighted and erythemal weighted daily doses during the cruise. All measurements were affected by the bad weather conditions. On 3 November heavy cloud coverage occurred and this explains the very low dose for this day. The maximal dose of 60,736 Joule (UV-B) and 3,442 Joule (Erythemal weighted = 16.4 MED, Minimal Erythemal Dose) were recorded on 12 November at sun elevation of 84.8°. The expected maximum should have been observed on 10 November at sun elevation of 89.2°. However, the cloud cover on this day reduced the dose.

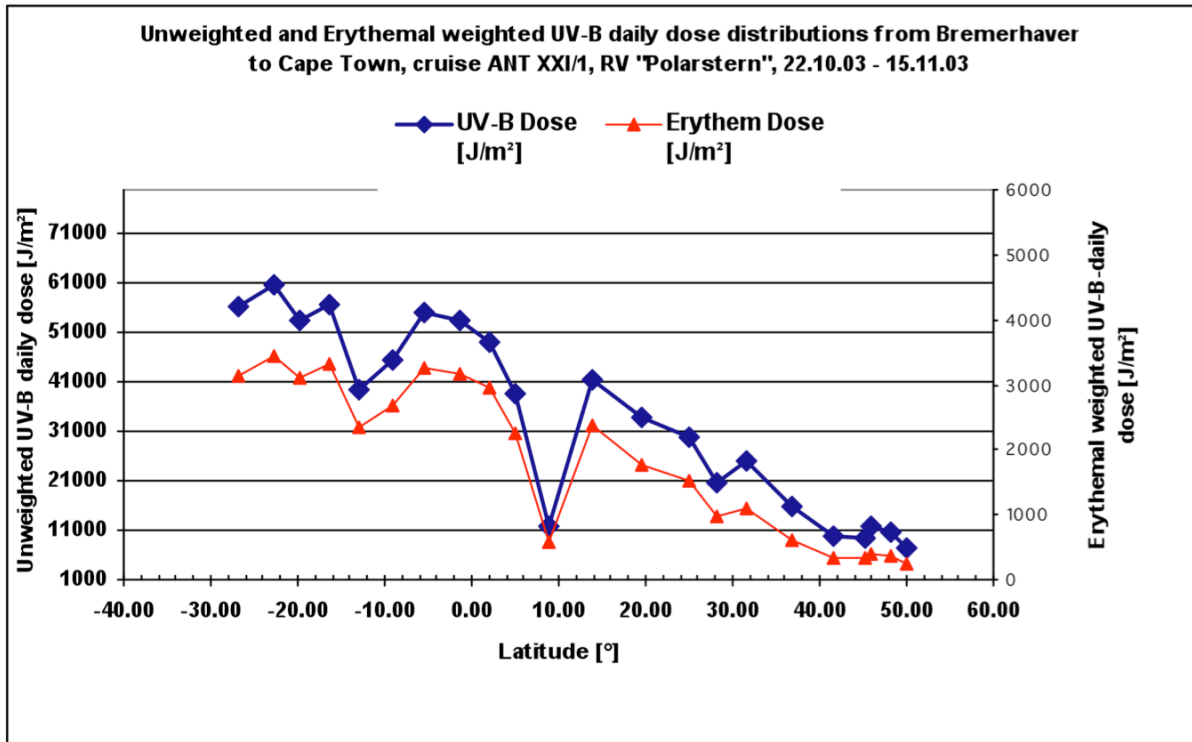

Fig. 3.5.4: UV-B Dose distributions between Bremerhaven and Cape Town during ARK XXI/1

Tab. 3.5.1: Summary of all relevant data of the UV-B measurement obtained during the cruise

Date	Zenith Time [UTC]	Latitude [deg]	Longitude [deg]	UV-B Dose [J/m ²]	Erythem Dose [J/m ²]	Erythem Dose [MED]	Ozone [DU]	Max.Sun Elevation [°]
22.10.2003								
23.10.2003	11:45	50.00	-1.40	7561.243	237.029	1.129		27.6
24.10.2003	12:25	48.25	-6.17	10655.266	370.615	1.765	304	30
25.10.2003	12:18	45.92	-4.40	11728.408	410.854	1.956	314	32
26.10.2003	12:23	45.23	-5.85	9229.694	320.715	1.527	342	32.4
27.10.2003	12:44	41.53	-10.46	9651.112	344.689	1.641	353	35.7
28.10.2003	12:51	36.80	-12.65	15988.919	597.644	2.846	337	40.1
29.10.2003	12:57	31.70	-14.38	24964.727	1085.619	5.170	305	44.6
30.10.2003	13:02	28.10	-15.36	20753.651	985.880	4.695	291	47.1

Date	Zenith Time [UTC]	Latitude [deg]	Longitude [deg]	UV-B Dose [J/m ²]	Erythem Dose [J/m ²]	Erythem Dose [MED]	Ozone [DU]	Max.Sun Elevation [°]
31.10.2003	13:20	24.95	-20.00	29785.035	1519.073	7.234	274	51
01.11.2003	13:21	19.44	-20.27	34081.547	1773.546	8.445	308	56.2
02.11.2003	13:23	13.92	-20.82	41636.427	2374.419	11.307	263	61,4°
03.11.2003	13:16	8.90	-19.10	11785.206	590.405	2.811	267	66.1
04.11.2003	13:04	5.10	-15.90	38729.338	2247.313	10.701	268	68.5
05.11.2003	12:54	2.14	-13.42	49259.385	2969.069	14.138	276	70.9
06.11.2003	12:42	-1.38	-10.37	53338.829	3175.600	15.122	335	72.5
07.11.2003	12:29	-5.42	-7.13	55145.765	3248.928	15.471	302	79.2
08.11.2003	12:16	-9.15	-3.98	45655.588	2677.968	12.752	279	82.4
09.11.2003	12:03	-12.96	-0.77	39642.769	2339.440	11.140	316	86.1
10.11.2003	11:48	-16.32	3.00	56658.246	3322.831	15.823	312	89.2
11.11.2003	11:33	-19.87	6.72	53551.800	3119.012	14.852	309	87.5
12.11.2003	11:23	-22.83	9.37	60736.217	3442.406	16.392	326	84.8
13.11.2003	11:10	-26.85	12.47	56412.877	3130.001	14.905	325	81.1
14.11.2003	10:56	-31.22	15.98				307	77.0

References

Groß, C., H. Tüg, and O. Schrems, (2001). Three years spectral resolved UV-measurements at Koldewey-Station (1997-1999), *Mem. Natl. Inst. Polar Res., Spec. Issue*, 54, 113-123

3.6 MAX-DOAS observation of tropospheric and stratospheric trace gases for validation of the SCIAMACHY instrument

Ossama Ibrahim Ahmed

Universität Heidelberg

not on board: Ulrich Platt, Thomas Wagner, Universität Heidelberg

Introduction

During the cruise of the research vessel *Polarstern* from Bremerhaven to Cape Town observations of the absorption spectra of the sun light scattered by atmospheric gases were performed daily. These observations were made by the proved DOAS method (Differential Optical Absorption Spectroscopy) in order to identify trace gases in the atmosphere by their characteristic absorption lines in the obtained spectra in different wavelength ranges of the scattered solar light and then to calculate their concentrations through analysis of the obtained data.

These measurements can identify trace gases and determine their concentrations like some mainly tropospheric trace gases as NO₂, H₂O, HCHO, IO and SO₂ and also some other mainly stratospheric trace gases (absorbers) as O₃, NO₂, BrO, OCIO, H₂O, HCHO, O₄ and IO.

Since some gases have absorptions only in the UV region, as BrO, SO₂, HCHO others have absorptions in the visible as H₂O and IO while some gases have

absorption in both ranges like O₃, NO₂, OCIO, and O₄, the MAX-DOAS (Multi Axis DOAS) instrument uses 2 separate instrumental setups :

- 1) The UV unit: covers the spectra range from about 300 to 400 nm and consists of 3 movable telescopes collecting light simultaneously from 3 different directions of sight. Every telescope is connected to an entrance slit with 7 glass fibres to the spectrograph and the resulting 3 spectra are then recorded by a 2-dimensional CCD array with 1,024 x 256 pixels.
- 2) The unit for the visible covers wavelengths from about 400 to 700 nm. It consists of one movable telescope connected to a spectrograph of 2,048 pixel CCD row by one glass fibre with a diameter 800 micrometer.

The collected scattered sunlight is dispersed by spectrographs and the resulting spectra are recorded by CCD detectors and collected data are saved on PC aboard *Polarstern* for later retrieval and analysis. The concentrations of atmospheric trace gases can be determined by analysis of the collected data.

Work at sea

About 4.2 GB of data were collected during ANT-XXI/1. The MAX-DOAS instrument was running continuously and performing measurements during the day and carrying out calibrations at night using Hg-Ne calibration lamps and Halogen lamps. The whole measurements and calibration processes are controlled automatically to a large extent by the measurement software.

Expected results

Since similar measurements were also performed by the SCHIAMACHY instrument on board of the ENVISAT satellite launched into a polar orbit in March 2002, it is important to validate the satellite data by making ground-based control measurements at locations beneath the satellite's orbit. The measurements on board of *Polarstern* are best suited for that purpose because during the Antarctica cruise, the ship follows a polar course convenient to the ENVISAT orbit. The validity and the value of SCIAMACHY data will depend on their exactness which is validated by the MAXDOAS ground-based measurements on board of *Polarstern*.

3.7 Multiphase halogen chemistry in the Atlantic marine boundary layer

Alex Pszenny^{1,2)}, Bill Keene³⁾, Astrid Kerkweg⁴⁾ John Maben³⁾, Tom O'Halloran³⁾, Rolf Sander⁴⁾ and Andy Wall²⁾

¹⁾ University of New Hampshire,

²⁾ Mount Washington Observatory, North Conway, USA

³⁾ University of Virginia, USA,

⁴⁾ Max-Planck-Institut für Chemie, Mainz, Germany

Introduction

Multiphase chemical transformations involving halogenated compounds impact important, interrelated chemical processes in the marine boundary layer (MBL). The phase partitioning of HCl regulates aerosol pH and associated pH-dependent reactions including halogen activation and S(IV) oxidation. Halogen radical chemistry catalytically destroys O₃, oxidizes hydrocarbons, dimethylsulfide, and S(IV), and modifies HO_x cycling. However, spatial and temporal variabilities in most reactant and product species and details concerning the nature of some chemical pathways are poorly characterized. Consequently, the global significance of chemical processes involving tropospheric halogens is very uncertain.

Detectable BrO (indicative of significant halogen radical chemistry) was first measured in the open-ocean MBL north of the Canary Islands during a boreal autumn 2000 cruise of *Polarstern* from Germany to South Africa. The present project is part of a more comprehensive follow-up investigation of chemical processes involving halogens along the same transect

Scientific objectives

- Measure diel variability of principal reactant and product species and related physical parameters relevant to inorganic halogen cycling in the marine boundary layer (MBL) along a latitudinal transect through the North and South Atlantic Oceans.
- Characterize variability in the pH of near-surface marine aerosol as functions of size, day versus night, latitude, and air-mass history (including transport regime) and associated chemical composition.
- Collaborate with other participating scientists in assessing details of halogen activation chemistry and related influences on the cycling, lifetimes, and environmental implications of tropospheric O₃ and S(IV).
- Model the relative importance of gaseous- versus particulate- dry deposition for major S and N compounds.

This research addresses the goals of the International Global Atmospheric Chemistry (IGAC) Project and Surface Ocean – Lower Atmosphere Study (SOLAS) elements of the International Geosphere-Biosphere Programme (IGBP).

Work at sea

Size-segregated aerosols were sampled with cascade impactors. These samples will be analyzed post-cruise for major ionic constituents. Total volatile inorganic Br was sampled with filterpacks, which will also be analyzed post-cruise. HCl* (primarily

HCl), Cl* (including HOCl and Cl₂), HNO₃, NH₃, SO₂, HCOOH, and CH₃COOH were sampled with mist chambers; these samples were analyzed onboard by ion chromatography. Aerosol pH as a function of size will be inferred from the measured phase partitioning of the gases and associated thermodynamic properties. Observations will be applied using box model calculations to test specific hypotheses regarding halogen chemistry and sulfur cycling in the marine atmosphere.

Thirty-one sets of aerosol and filter pack samples were collected during the cruise. Samples were transferred into clean centrifuge tubes, sealed in glass mason jars and frozen at -20°C to minimize degradation. Over 175 mist chamber samples were collected and analyzed. Due to failure of one of four ion chromatography systems early during the cruise preliminary data are available now only for HCl* for part of the cruise. These data indicate mixing ratios of 400 to 1200 pptv HCl* during the period 23 - 27 October (English Channel to Bay of Biscay) and 200 to 500 pptv from 30 October to 1 November (track portion from ~33°N to ~21°N).

Expected results

Once the analyses are complete, the obtained results will provide critical and hitherto unavailable constraints on knowledge concerning multiphase halogen cycling and aerosol pH over a broad range of MBL conditions and the related influences on Earth systems including climate. The study also trains graduate students and strengthen partnerships between European and U.S. scientists. The results of this project will be disseminated through scholarly and public presentations, scientific journals, popular articles, and freely accessible data archives.

3.8 Global marine sources of reactive halogen species

Paul I Williams¹⁾, James Hopkins²⁾,
Carl Parlmer²⁾, Ossama Ibrahim
Ahmed³⁾

¹⁾University of Manchester, UK

²⁾University of York, UK

³⁾Universität Heidelberg, Germany

Introduction

Over the last decade it has been established that catalytic cycles involving reactive halogen species (RHS) are responsible for ozone depletion events in the troposphere. Active RHS chemistry has so far been demonstrated in regions including (i) the Arctic and around Antarctica where abrupt bromine oxide (BrO) “episodes” completely destroy surface ozone in timescales of hours to days (Barrie et al., 1988; Bottenheim et al., 1990; Tuckermann et al., 1997), (ii) coastal areas where concentrations of the IO radical can be sufficiently high to double the marine boundary layer (MBL) depletion rate of O₃ (Alicke et al., 1999; McFiggans et al., 2000) and (iii) the Dead Sea Valley where the highest tropospheric BrO concentrations to date have been observed (Hebestreit et al., 1999). The sources of RHS and/or their precursors in these regions include sea ice, ice algae, salt pans and coastal macroalgae.

It is now emerging that tropospheric bromine and iodine chemistry may not be confined to these specific areas and sources. IO has recently been detected at concentrations of up to 3 pptv (parts per trillion by volume) in air masses with little or no coastal influence (Allan et al., 2000). The most recent measurements of BrO from balloons, aircraft and satellites indicate a free tropospheric background of BrO of about 10⁷-10⁸ molecules cm⁻³ (e.g., Fitzenberger et al., 2000). The implications of a more widespread abundance of IO and BrO are profound. An important consequence is that the rate of tropospheric ozone destruction may be currently underestimated, which in turn suggests that tropospheric ozone production may also be underestimated.

A detailed understanding of the marine aerosol surface area is vital, as the proposed chemical pathways include the uptake and processing of BrO and IO by-products by aerosol. As a result, gas phase Br and I may be enhanced as the aerosol processing can lead to multiplying and subsequent outgassing of these molecules.

Collaboration between UMIST, York University and the University of Heidelberg was set up to study the effects and importance of marine halogen chemistry, away from coastal sources. Participants on the 2003 cruise were Dr. Paul I. Williams (UMIST), Dr. James Hopkins and Carl Parlmer (York) and Ossama Ibrahim Ahmed (Heidelberg). Modelling of the chemical reactions, both in the gas phase and aerosol phase, is to be carried out at UMIST by Dr. Gordon McFiggans once all the data has been collated.

Work at sea

Measurements onboard included aerosol size number distribution (in the size range 5nm to 20 μm), carbon monoxide (CO), O₃, organo-halogens including C_nH_{2n+1}I (n=1-3), CH₂XY and CHXYZ (X,Y, Z = I, Br, Cl) and BrO and IO.

Preliminary results

Preliminary results indicate that there is a good and almost continuous data set for the aerosol size distributions, CO and O₃ and that the cruise had been a success. The halogen gas data set is still being validated and some water samples have also been taken.

Some very marked difference between the Northern and Southern hemispheres have been seen and are shown in figure 3.8.1. This shows the total number concentration for aerosol particles with a diameter (D_p) < 1.0 μm for the 2003 and 2002 cruises. There are similarities between the cruises as a function of latitude, the most marked being the drop in total number south of 10°N. Differences between the cruises can be explained by the wind direction and back trajectories. Figure 3.8.2 re-plots the total number concentration on a 2D map and has a sample of the aerosol size distributions from the contrasting regions. The solid curve is data from the UMIST differential mobility particle sizer (DMPS) for sizing and counting particles in the range 5 nm – 820 nm, the dashed from the UMIST optical particle counter (Supplied by Grimm) for the size range 0.3 μm to 20 μm . In the Northern hemisphere, high concentrations of particles are seen in all sizes, extending down to the sub 20 nm size range (ultra fine particles). South of 10°N and on the Southern hemisphere, a different distribution is observed. The distribution is regularly tri-modal with mode diameters around 60 - 100 nm, 200 - 300 nm and 1-2 μm . Furthermore, the total number concentration is two orders of magnitude lower and few, if any, particles exist below 20 nm. The lowest aerosol number concentration of 25 particles per cubic centimetre was recorded on 8 November. The average in the clean Southern hemisphere is about 300 - 450 per cubic centimetre.

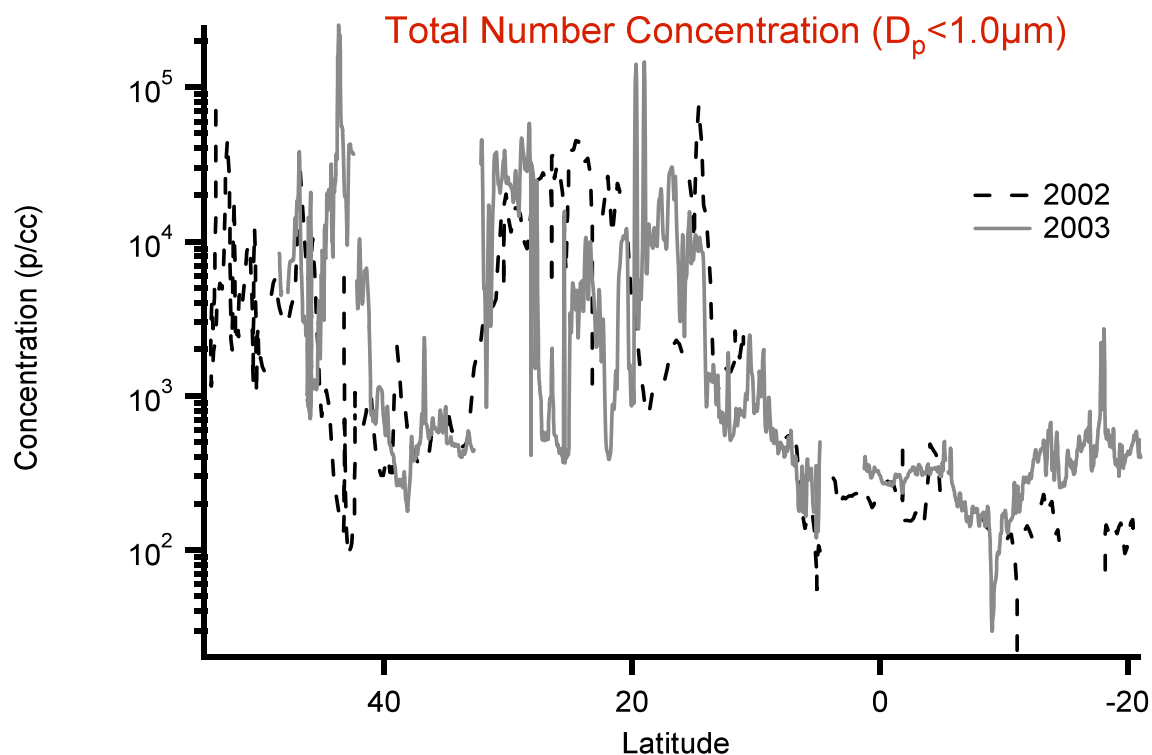

Fig. 3.8.1: Total number concentration from the UMIST DMPS

The reason for the lower concentrations is due to the relatively clean air in the Southern Atlantic. The York CO analyser (supplied by Aerolaser) has recorded values of around 60 - 70 parts per billion by volume (ppbv), which suggests that the air masses have not been influenced by any anthropogenic sources. This is further supported by the daily back trajectories which indicated that air masses sampled have not been over land for several days.

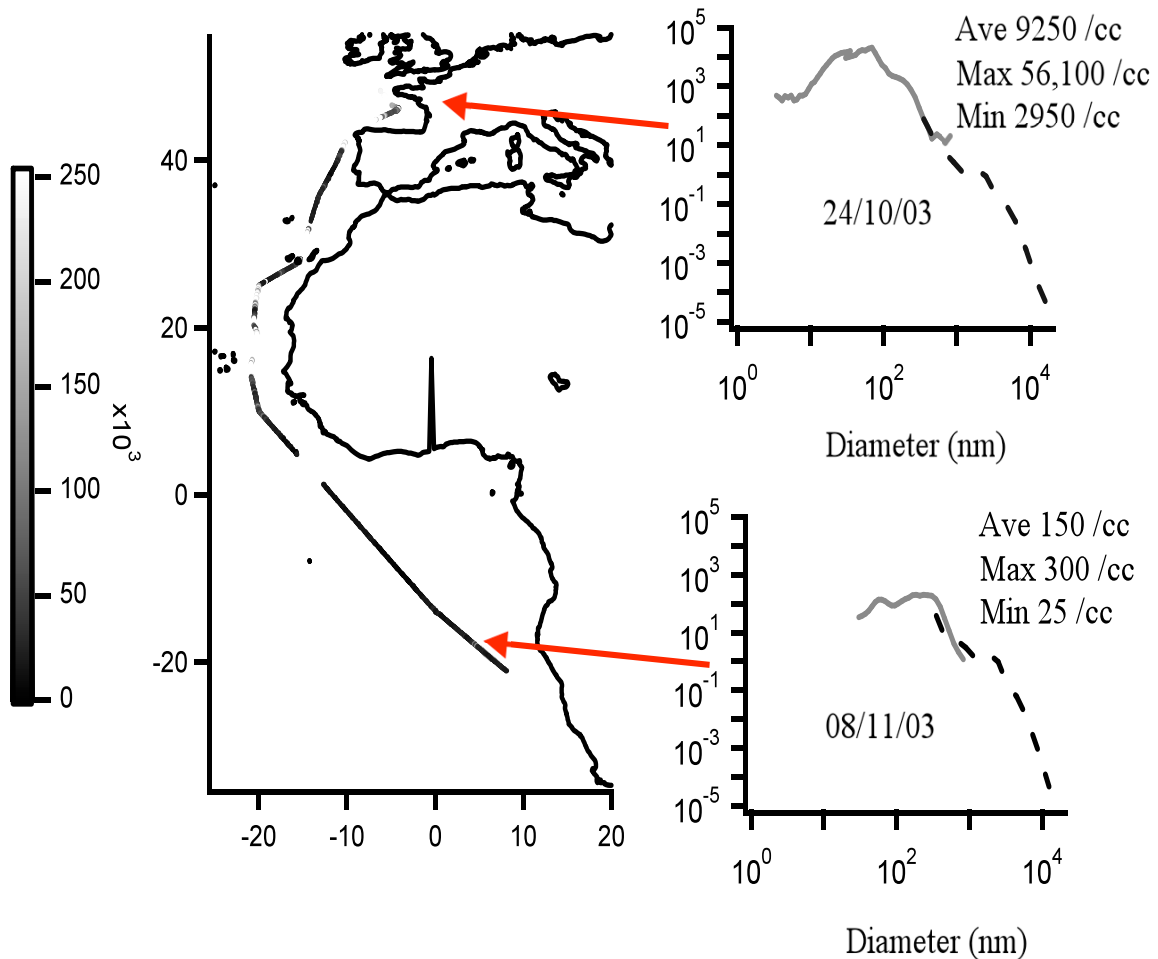

Fig. 3.8.2 : Total number concentration as a function of the ship's course and examples of the aerosol size distributions

References

- Alicke B., K. Hebestreit, J. Stutz and U. Platt, Iodine oxide in the marine boundary layer, *Nature*, 397, 572-573, 1999.
- Allan B. J., G. McFiggans, J. M. C. Plane, H. Coe, Observations of iodine monoxide in the remote marine boundary layer, *J. Geophys. Res.*, 105, 14363-14369, 2000.
- Barrie, L. A., J. W. Bottenheim, R. C. Schnell, P. J. Crutzen and R. A. Rasmussen, Ozone destruction and photochemical reactions at polar sunrise in the lower Arctic atmosphere, *Nature*, 334, 138-141, 1988.
- Bottenheim, J. W., L. A. Barrie, E. Atlas, L. E. Heidt, H. Niki, R. A. Rasmussen, and P. B. Shepson, Depletion of lower tropospheric ozone during Arctic spring: The Polar Sunrise Experiment, *J. Geophys. Res.*, 95, 18555-18568, 1990.
- Fitzenberger R., Bosch H., Camy-Peyret C., Chipperfield M.P., Harder H., Platt U., Sinnhuber B.M., Wagner T., Pfeilsticker K., First profile measurements of tropospheric BrO, *Geophys. Res. Lett.*, 27, 2921-2924, 2000.
- Hebestreit, K., Stutz J., Rosen D., Mateev V., Pelev M., Laira M., and Platt U., First DOAS Measurements of Tropospheric BrO in Mid Latitudes, *Science*, 283, 55-57, 1999.

- McFiggans, G., B. Allan, H. Coe, J. M. C. Plane, L. J. Carpenter and C. O'Dowd, Observations of IO and a modelling study of iodine chemistry in the marine boundary layer, *J. Geophys. Res.*, 105, 14,371-14,385, 2000.
- Tuckermann, M., R. Ackermann, C. Golz, H. Lorenzen-Schmidt, T. Senne, J. Stutz, B. Trost, and U. Platt, DOAS-Observation of Halogen Radical-Catalysed Arctic Boundary Layer Ozone Destruction during the ARCTOC Campaigns 1995 and 1996 in Ny-Alesund, Spitsbergen, *Tellus 49B*, 533-555,

3.9 Levels and patterns of organic nitrates in the northern and southern hemisphere

Anke Grünert
University of Ulm
not on board: Karlheinz Ballschmiter, University of Ulm

Objectives

Global aspects of environmental chemistry – in this case especially of the atmospheric chemistry – become more and more significant. Therefore, a precise knowledge about possible reaction cycles and the involved trace gases is necessary. The aim of this project was to investigate the levels and patterns of organic nitrates in the northern and southern hemisphere. These data will help to identify the sources and sinks of these compounds. As it has been established in investigations of other compounds in our research group, the exchange between the marine boundary layer and the seawater surface seems to play an important role (Schreitmüller, J. et al., 1994 and 1995). Beside the importance of the distribution in the two hemispheres the varying levels and patterns during day and night time chemistry are a main aspect.

Work at sea

During the expedition ANT-XXI/1 low volume air samples were taken on different adsorbent materials. The amounts of air ranged from 2 l up to 100 l. Because of the extremely high surface area of *Hayesept D* this material was only used for the very low samples (14 samples). Most of the 70 samples were taken on *TENAX TA*. The air samples have extremely low levels of organic nitrates. Thus, it is very important to take care about contamination caused by the ship. After passing the ITCZ all air samples were collected at the "crow's nest" where the air flow of the south-east trade wind came from the front. Some of the northern hemisphere samples had to be taken at the helideck because the air flow was coming from the north.

Expected results

The analysis of the air samples will be performed at the University of Ulm with a Chrompack Thermal desorption unit (TCT 4001) coupled with an HP HRGC-ECD-system HP HRGC-MSD, respectively. The obtained results will then be compared with data of former ship expeditions in order to improve the knowledge of the behaviour of organic nitrates in the lower marine atmosphere (Fischer, R. et al., 2000; Ballschmiter, K., 2002).

References

- J. Schreitmüller, K. Ballschmiter, "The Equilibrium Distribution of Semivolatile Organochloro Compounds between Atmosphere and Surface Water in the Atlantic Ocean", *Angew. Chem. Int. Ed. Engl.* 33 (1994) 646-649; *Angew. Chem.* 106 (1994) 688-691.
- J. Schreitmüller, K. Ballschmiter, "Air-Water Equilibrium of Hexachlorocyclo-hexanes and Chloromethoxybenzenes in the North and South Atlantic", *Environ. Sci. Technol.* 29 (1995) 207-215.
- R. G. Fischer, J. Kastler, K. Ballschmiter, „Levels and pattern of alkyl nitrates, multifunctional alkyl nitrates, and halocarbons in the air over the Atlantic Ocean“, *J. Geophys. Res.* 105/11 (2000) 14,473-14,494.
- K. Ballschmiter, "A Marine Source of Alkyl Nitrates", *Science*, 297 (2002) 1127-1128.

4. MARINE CHEMISTRY

4.1 ¹³C-sampling programme during *Polarstern* transits

Sarah Gebhardt

Universität Kiel

not on board: Arne Körtzinger, Universität Kiel

Objectives

The primary goal of the ¹³C sampling programme was to study the interannual variability and long term trends in the air-sea $\delta^{13}\text{C}$ -DIC disequilibrium of surface waters in the Atlantic Ocean. The project is meant to be a long-term study which involves sampling during all *Polarstern* transits to/from the Southern Ocean. It is a joint project of Prof. Dr. Paul Quay of the School of Oceanography, University of Washington, Seattle/WA, U.S.A. and Prof. Dr. Arne Körtzinger of the Institut für Meereskunde, Kiel.

Work at sea

During each transect, surface samples for $\delta^{13}\text{C}$ -DIC measurements were taken with regular spacing along the entire cruise track. These samples will be measured at Paul Quay's Stable Isotope Laboratory. For this purpose, the CO_2 is extracted to $100 \pm 0.5\%$ using a helium stripping technique, and the $^{13}\text{C}/^{12}\text{C}$ ratio of the extracted CO_2 is later measured on a Finnigan MAT 251 isotope ratio mass spectrometer. The overall precision of $\delta^{13}\text{C}$ analyses is typically $\pm 0.02\text{‰}$ based on replicate analyses of standards and seawater samples (Quay et al., 1992).

In order to enhance interpretation of the $\delta^{13}\text{C}$ data (Körtzinger et al., 2002), parallel sampling for dissolved inorganic carbon (DIC) and total alkalinity (A_T) was carried out with a similar number of samples. The water samples were collected from a seawater pumping system at a depth of 11 m at the keel of the vessel. The system works with a "Klaus"-pump, the tube which leads the water into the lab are made of teflon. Temperature- and salinity data were measured by a thermosalinograph nearby the water in-flow. All samples are poisoned with 100 μL saturated HgCl_2 -solution. Measurements of DIC and A_T will be carried out in Kiel using the following techniques: DIC is measured by coulometric titration following extraction of the CO_2 with an automated system known as SOMMA (Johnson et al., 1993). A_T is determined by potentiometric titration in an open cell (Mintrop et al., 2000 and references therein). DIC and A_T analyses are checked every 10–15 samples by measuring a certified reference material provided by A. Dickson (Scripps Institution of Oceanography, La Jolla, CA, U.S.A.). The estimated typical accuracy is $1.5 \mu\text{mol}\cdot\text{kg}^{-1}$ for DIC and $2.5 \mu\text{mol}\cdot\text{kg}^{-1}$ for A_T .

The samples are collected during leg 1 and 5 of the *Polarstern* cruise ANT-XXI.

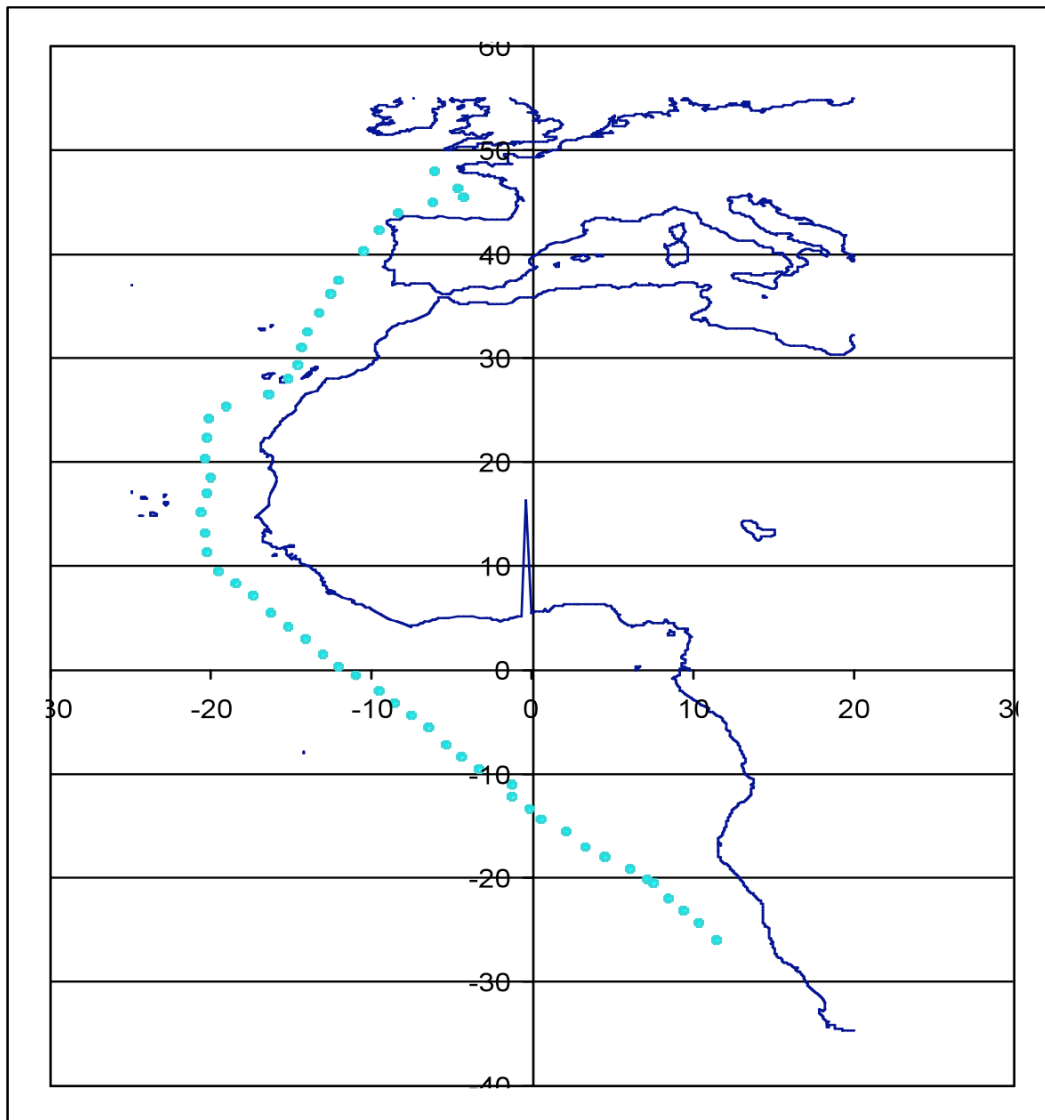

Fig. 4.1: Overview of the sampling positions

References

- Johnson, K.M., Wills, K.D., Butler, D.B., Johnson, W.K., Wong, C.S., 1993. Coulometric total carbon dioxide analysis for marine studies: maximizing the performance of an automated gas extraction system and coulometric detector. *Mar. Chem.*, **44**, 167-187.
- Körtzinger, A., P.D. Quay, and R.E. Sonnerup, 2003. Relationship between anthropogenic CO₂ and the ¹³C Suess effect in the North Atlantic Ocean, *Global Biogeochem. Cycles*, **17**, 1005-1024.
- Mintrop, L., Pérez, F.F., Gonzalez-Davila, M., Santana-Casiano, J.M., Körtzinger, A., 2000. Alkalinity determination by potentiometry – intercalibration using three different methods. *Ciencias Marinas*, **26**, 23-37.
- Quay, P.D., B. Tilbrook, and C.S. Wong, Oceanic uptake of fossil fuel CO₂: Carbon-13 evidence, *Science*, **256**, 74-79, 1992.

5. ACOUSTICS

5.1 Sea acceptance test of the Hydrosweep multibeam system in the Bay of Biscay

Hans Werner Schenke¹⁾, Andreas Beyer¹⁾, Saad El Naggar¹⁾, Fred Niederjasper¹⁾, Martin Dittmer²⁾

¹⁾Alfred-Wegener-Institut

²⁾Atlas Hydrographic GmbH

Objectives

The software upgrade of the new operating modes “High Definiton Bearing Estimation (HDBE)” and “Automatic Source Level Control (ASLC)” of the Hydrosweep System was evaluated and tested during the first leg of ANT-XXI/1, Bremerhaven to Las Palmas / Gran Canaria (Fig. 5.1.1), on the base of the Sea Trial Acceptance Protocol.

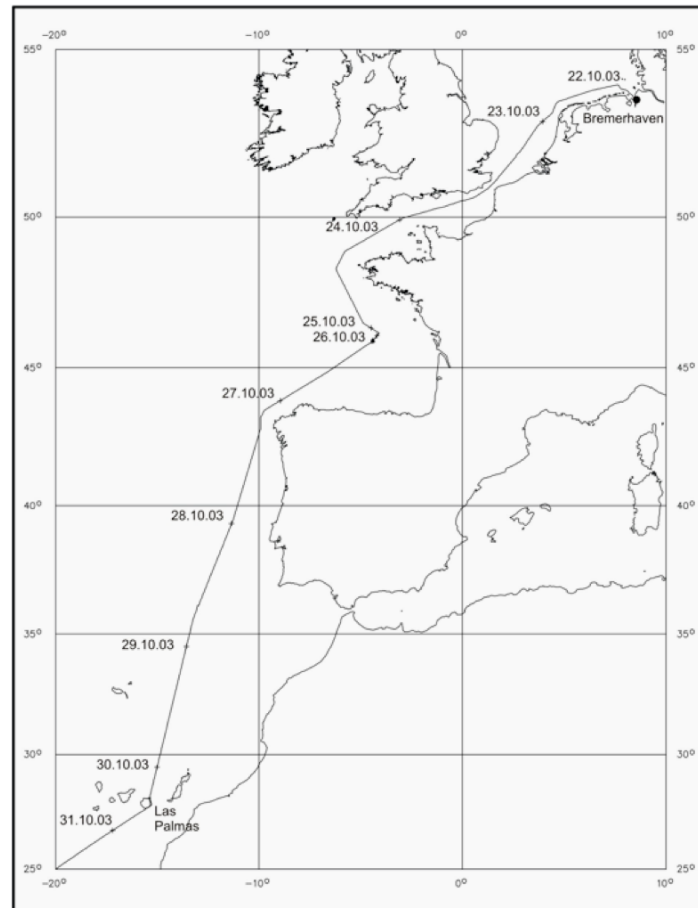

Fig. 5.1.1: ANT-XXI/1 cruise track of the first leg Bremerhaven to Las Palmas

Work at sea

Most of the tests were carried out in the French part of the Bay of Biscay at the continental slope by water depths of 200 to 4,000 m. The established test area "Location 2b", in which previous deep sea trials were carried out with Hydrosweep DS-1 and DS-2 (first version), could not be used in full expansion, because of geographic restrictions given in the French research permission. Therefore the region of the Canyon de Noirmoutier (Fig. 5.1.2) of which well known bathymetry is also available, was utilized for the trials. A new test area "Location 2c" (Fig. 5.1.3) was established at the foot of the canyon.

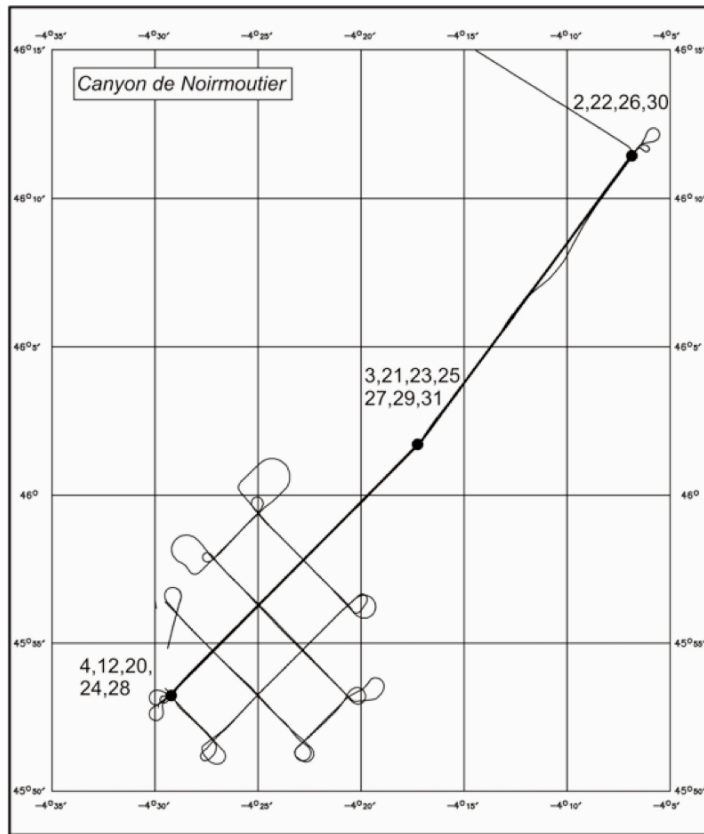

Fig. 5.1.2: ANT-XXI/1 cruise track and waypoint numbers at the Hydrosweep test site "Canyon de Noirmoutier".

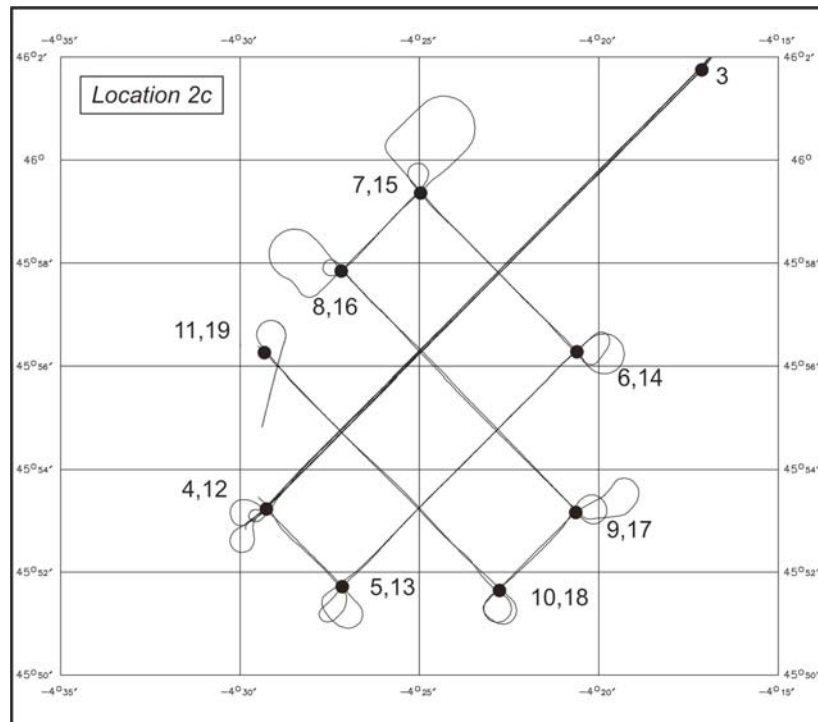

Fig. 5.1.3: ANT-XXI/1 cruise track and waypoint numbers at the Hydrosweep test site "Location 2c"

Location 2c is located at the south-west end of the Canyon de Noirmoutier. The test surveys were carried out between 25 and 26 October 2003. During that time the tracks in both areas were sailed and surveyed with Hydrosweep several times with different settings of the new survey modes. Details are shown in table 5.1.1.

Results

Programming errors, inherent in the HDBE software upgrade of the Hydrosweep system generated noisy and erroneous data and systematic outliers of the outer beams which were found during the trials. Crashes of the Hydrosweep operating system happened occasionally. Therefore it was not possible to work through all points of the sea acceptance test in detail. In close cooperation with the technician from the manufacturer, efforts were taken to describe the errors, install the software fixes obtained during the trials and test the system again. Shortly before the end of the first part of the cruise in Las Palmas, most of the serious problems were fixed, but there was not enough time left to repeat all required tests a second time.

The ASLC mode depends on a correct estimation of the gain of the received signal. It was shown that this function doesn't work properly which means as a result that the ASLC mode could not be used as desired.

It was agreed that the remaining problems with HDBE and ASLC would have to be solved by Atlas remotely by internet including test measurements carried out with support of the ship's system manager in due time before the subsequent expedition.

5.1 Sea acceptance test of the Hydrosweep multibeam system in the Bay of Biscay

Tab. 5.1.1: Waypoint list of tracklines for the HDBC/ASLC trials, including geographical coordinates, date and time of the Hydrosweep profiles and variation of the Hydrosweep_{NBS}

Waypoint	Date	Time UTC	Latitude	Longitude	WP (end point of profile)	Transmit Angle	Receive Angle	HDBE Mode	Parameter	Calibration Mode	Parasound On/Off	Comment
	25.10.03	05:53	45° 59.33'N	4° 24.89'W	7	90	90	Standard		Never	off	End of profile
7	25.10.03	06:24	45° 59.43'N	4° 24.90'W		90	90	Standard		Never	off	Begin of profile
	25.10.03	06:37	45° 57.87'N	4° 27.14'W	8	90	90	Standard		Never	off	End of profile
8	25.10.03	07:00	45° 57.79'N	4° 27.07'W		90	90	Standard		Never	off	Begin of profile, RPM of propeller set to 537, 28% pitch
	25.10.03	07:39	45° 53.14'N	4° 20.53'W	9	90	90	Standard		Never	off	End of profile
9	25.10.03	08:04	45° 53.18'N	4° 20.62'W		90	90	Standard		Never	off	Begin of profile
	25.10.03	08:17	45° 51.69'N	4° 22.75'W	10	90	90	Standard		Never	off	End of profile
10	25.10.03	08:26	45° 51.48'N	4° 22.43'W		90	90	Standard		Never	off	Begin of profile
	25.10.03	09:08	45° 56.37'N	4° 29.46'W	11	90	90	Standard		Never	off	End of profile, transmission off
12	25.10.03	09:32	45° 53.47'N	4° 29.50'W		90	90	Standard		Never	off	Begin of profile, transmission on
	25.10.03	ca. 09:50	45° 51.52'N	4° 27.03'W	13	90	90	Hardbeam		Never	off	End of profile, switch to hardbeam mode
13	25.10.03	10:01	45° 51.81'N	4° 27.02'W		90	90	Hardbeam		Never	off	Begin of profile
	25.10.03	10:40	45° 56.27'N	4° 20.67'W	14	90	90	Hardbeam		Never	off	End of profile
14	25.10.03	10:56	45° 56.21'N	4° 20.57'W		90	90	Hardbeam		Never	off	Begin of profile
	25.10.03	11:23	45° 59.38'N	4° 25.00'W	15	90	90	Hardbeam		Never	off	End of profile
15	25.10.03	11:33	45° 59.35'N	4° 25.06'W		90	90	Hardbeam		Never	off	Begin of profile
	25.10.03	11:45	45° 57.91'N	4° 27.06'W	16	90	90	Hardbeam		Never	off	End of profile, beams 38-48 with wrong depths (to deep)
16	25.10.03	11:53	45° 57.90'N	4° 27.16'W		90	90	Hardbeam		Never	off	Begin of profile
	25.10.03	12:31	45° 53.20'N	4° 20.66'W	17	90	90	Hardbeam		Never	off	End of profile
17	25.10.03	12:42	45° 53.24'N	4° 20.67'W		90	90	Hardbeam		Never	off	Begin of profile
	25.10.03	12:55	45° 51.67'N	4° 22.80'W	18	90	90	Hardbeam		Never	off	End of profile

Tab. 5.1.1 continued: Waypoint list of tracklines for the HDBC/ASLC trials, including geographical coordinates, date and time of the Hydrosweep profiles and variation of the Hydrosweep parameter settings

Waypoint	Date	Time UTC	Latitude	Longitude	WP (end point of profile)	Transmit Angle	Receive Angle	HDBE Mode	Parameter	Calibration Mode	Parasound On/Off	Comment
18	25-10-03	13:07	45° 51.66'N	4° 22.86'W		90	90	Hardbeam		Never	off	Begin of profile
	25-10-03	13:46	45° 56.18'N	4° 29.14'W	19	90	90	Hardbeam		Never	off	End of profile
	25-10-03	13:50	45° 56.74'N	4° 29.49'W		90	90	Hardbeam		Never	off	Transmission off, data recording stop
	25-10-03	14:30										For unknown reason system does not start,
	25-10-03	15:24										After several tries system starts operating
20	25-10-03	15:30	45° 53.08'N	4° 29.58'W		90	90	ASLC	Max. Source Lev. 239 dB Desired S/N 20 dB Desired Coverage 90° Equal Angle	Never	off	
	25-10-03	15:35	45° 53.64'N	4° 28.78'W		90	90	ASLC		Never	off	Outlier on both sides, IP reset, data recording stop
	25-10-03	16:42	46° 01.71'N	4° 17.26'W	21	90	90	ASLC		Never	off	
21	25-10-03	16:42	46° 01.71'N	4° 17.26'W		90	90	ASLC		Never	off	Continue survey after IP reset
	25-10-03	16:55	46° 03.51'N	4° 15.32'W		90	90	ASLC		Never	off	Outlier, 2/3 of data are corrupt
	25-10-03	17:09	46° 05.42'N	4° 13.29'W		90	90	ASLC		Never	off	No depth profile visible because of a bug in the "min depth" adjustment
	25-10-03	17:21	46° 07.01'N	4° 11.62'W		90	90	ASLC		Never	off	Change to medium depth automatically
	25-10-03	17:55	46° 11.51'N	4° 06.79'W	22	90	90	ASLC	Max. Source Lev. 239 dB Desired S/N 10 dB	Never	off	
22	25-10-03	18:05	46° 11.48'N	4° 06.82'W		90	90	ASLC	Max. Source Lev. 233 dB Desired S/N 10 dB	Never	off	Used Source Lev. down to 207 dB, stop survey at ~18:50
	25-10-03	19:00	46° 04.32'N	4° 14.39'W		90	90	ASLC	Max. Source Lev. 239 dB Desired S/N 10 dB	Never	off	Factor SLARW changed from 180 dB to 206 dB, IP reset, restart of data recording
	25-10-03	19:30	46° 00.64'N	4° 18.72'W	23	90	90	ASLC		Never	off	WP 23 at 19:20, good data quality since 19:30
23	25-10-03	19:30	46° 00.64'N	4° 18.72'W		90	90	ASLC		Never	off	
	25-10-03	20:35	45° 53.28'N	4° 29.21'W	24	90	90	ASLC		Never	off	ASLC uses 239 dB Max. Source Lev. only, factor SLARW changed from 206 dB to 180 dB,

Tab. 5.1.1 continued: Waypoint list of tracklines for the HDBC/ASLC trials, including geographical coordinates, date and time of the Hydrosweep profiles and variation of the Hydrosweep parameter settings

Waypoint	Date	Time UTC	Latitude	Longitude	WP (end point of profile)	Transmit Angle	Receive Angle	HDBE Mode	Parameter	Calibration Mode	Parasound On/Off	Comment
24	25.10.03	20:41	45° 53.07'N	4° 29.36'W		120	120	ASLC	Max. Source Lev. 239 dB Desired S/N 10 dB	Never	off	Survey speed 10.5 kt
	25.10.03	21:18	45° 57.66'N	4° 23.05'W		120	120	ASLC		Never	off	S/N 30 dB, slowly increasing source level to 2 dB. ASLC control doesn't work
	25.10.03	21:43	46° 00.63'N	4° 18.81'W		120	120	ASLC		Never	off	Switch to equal footprint for a short time -> cross profile looks better
	25.10.03	21:54	46° 01.90'N	4° 17.04'W	25	120	120	ASLC		Never	off	Change of course, evasion manoeuvre
25	25.10.03	21:54	46° 01.90'N	4° 17.04'W		120	120	ASLC		Never	off	
	25.10.03	22:24	46° 05.88'N	4° 12.81'W		120	120	ASLC		Never	off	Water depth 1520 m, some loss of data starboard side
	25.10.03	23:06	46° 11.69'N	4° 06.58'W	26	120	120	Standard		Never	off	Medium depth, 227 dB source level indicated
26	25.10.03	23:20	46° 11.70'N	4° 06.53'W		120	120	Standard		Never	off	Medium depth, 229 dB source level indicated
	26.10.03	00:33	46° 01.93'N	4° 16.93'W	27	120	120	Standard		Never	off	
27	26.10.03	00:33	46° 01.93'N	4° 16.93'W		120	120	Standard		Never	off	
	26.10.03	01:08	45° 57.71'N	4° 22.90'W		120	120	Standard		Never	off	Switch between equal footprint / equal angle because of outlier at port side till 01:10
	26.10.03	01:45	45° 53.13'N	4° 29.45'W	28	120	120	Standard		Never	off	End of profile
28	26.10.03	01:59	45° 53.20'N	4° 29.32'W		90	90	Standard		Never	off	Begin of profile
	26.10.03	03:10	46° 01.74'N	4° 17.21'W	29	90	90	Standard		Never	off	End of profile
29	26.10.03	03:10	46° 01.74'N	4° 17.21'W		90	90	Standard		Never	off	Begin of profile
	26.10.03	03:30	46° 04.58'N	4° 14.19'W		90	90	Standard		Never	off	Switch between equal footprint / equal angle because of outlier at outer sides of swath
	26.10.03	03:46	46° 06.84'N	4° 11.78'W		120	120	Standard		Never	off	Equal angle
	26.10.03	04:21	46° 11.49'N	4° 06.81'W	30	120	120	Standard		Never	off	End of profile
30	26.10.03	04:31	46° 11.37'N	4° 06.98'W		120	120	Standard		Never	off	Begin of profile
	26.10.03	05:08	46° 06.59'N	4° 11.98'W		90	90	Standard		Never	off	Outliers at outer sides of swath after changing the angle

Tab. 5.1.1 continued: Waypoint list of tracklines for the HDBC/ASLC trials, including geographical coordinates, date and time of the Hydrosweep profiles and variation of the Hydrosweep parameter settings

Waypoint	Date	Time UTC	Latitude	Longitude	WP (end point of profile)	Transmit Angle	Receive Angle	HDBE Mode	Parameter	Callibration Mode	Parasound On/Off	Comment
	24.10.03	17:17	47° 21.11'N	5° 29.82'W		90	90	Standard	Medium Depth	Standard	off	Sea Acceptance Test, checkpoint 4.3.7; 14
	24.10.03	17:32	47° 18.19'N	5° 27.51'W		90	90	ASLC	Medium Depth Max. Source Lev. 239 dB Desired S/N 20 dB Desired Coverage 90°	Standard	off	Sea Acceptance Test, checkpoint 4.3.7; 18
	24.10.03	17:50	47° 14.63'N	5° 24.52'W		90	40	ASLC	Medium Depth Max. Source Lev. 230 dB Desired S/N 20 dB Desired Coverage 40°	Standard	off	Sea Acceptance Test, checkpoint 4.3.7; 22 until 18:04
	25.10.03	00:35	46° 18.15'N	4° 21.68'W		90	90	ASLC	Different Settings	Standard	off	Several tests with ASLC
2	25.10.03	01:42	46° 11.51'N	4° 06.79'W		120	120	Standard		Standard	off	
	25.10.03	01:56	46° 09.18'N	4° 09.25'W		120	120	Standard		Never	off	Switch to water sound velocity profile
	25.10.03	02:15	46° 06.64'N	4° 11.94'W		90	90	Standard		Never	off	
	25.10.03	02:50	46° 01.88'N	4° 16.98'W	3	90	90	Standard		Never	off	
3	25.10.03	02:50	46° 01.88'N	4° 16.98'W		90	90	Standard		Never	off	
	25.10.03	03:39	45° 55.88'N	4° 25.53'W		90	90	Standard		Never	off	Operation stop for IP reset
	25.10.03	03:45	45° 55.13'N	4° 26.59'W		90	90	Standard		Never	off	Operation restart
	25.10.03	04:00	45° 53.28'N	4° 29.27'W	4	90	90	Standard		Never	off	End of profile
4	25.10.03	04:12	45° 53.19'N	4° 29.24'W		90	90	Standard		Never	off	Begin of profile
	25.10.03	04:24	45° 51.75'N	4° 27.19'W	5	90	90	Standard		Never	off	End of profile
5	25.10.03	04:39	45° 51.81'N	4° 27.15'W		90	90	Standard		Never	off	Begin of profile
	25.10.03	05:16	45° 56.26'N	4° 20.66'W	6	90	90	Standard		Never	off	End of profile
6	25.10.03	05:29	45° 56.38'N	4° 20.74'W		90	90	Standard		Never	off	Begin of profile
	25.10.03	05:33				90	90	Standard		Never	off	Switch to equal footprint because of less of outer beams
	25.10.03	05:36				90	90	Standard		Never	off	Switch back to equal angle because of missing affect

5.2 Sediment acoustics: Software replacement and data collection

Andrea Gerriets¹, Gerhard
Kuhn²

¹University of Bremen
²Alfred-Wegener-Institut

Objectives

Two main goals were achieved during the cruise we had participated after Canary Islands. First the old DOS-based software for data collection of the Parasound sediment echosounder was replaced by a Windows-based software and secondly, approximately 2,000 nm (ca. 8 GBytes) of sub-bottom echosounder data had been collected. In addition to that, data of the swath bathymetric echosounder HYDROSWEEP were recorded, too.

Parasound / ParaDigMA

System Description Parasound

The Parasound echosounder DS-2 designed by ATLAS Hydrographic is a permanently installed system on *Polarstern*. It determines the water depth and detects variable frequencies from 2.5 up to 5.5 kHz thereby providing high-resolution information of the sedimentary layers up to a depth of 200 meters below sea floor. For the sub-bottom profiler task, the system uses the parametric effect, which produces additional frequencies through non-linear acoustic interaction of finite amplitude waves. If two sound waves of similar frequencies (18 kHz, 22 kHz) are emitted simultaneously, a signal of the resulting frequency (e.g. 4 kHz) is generated for sufficiently high primary amplitudes. The new component is travelling within the emission cone of the original high frequency waves, which are limited to an angle of 4° for the equipment used. The resulting footprint size of 7 % of the depth is much smaller than for conventional systems and both vertical and lateral resolutions are significantly improved. The Parasound system sends out a burst of pulses at 400 ms intervals until the first echo returns. The coverage of this discontinuous mode depends on the water depth, and produces non-equidistant shot intervals between bursts.

Replacement of DOS ParaDigMA by Windows ParaDigMA

For about 10 years the ATLAS Parasound system had been equipped with the associated DOS-based data acquisition system ParaDigMA developed by V. Spieß (1993, University of Bremen). The ParaDigMA software offers the visualisation as well as the digitisation and storage of acoustic soundings.

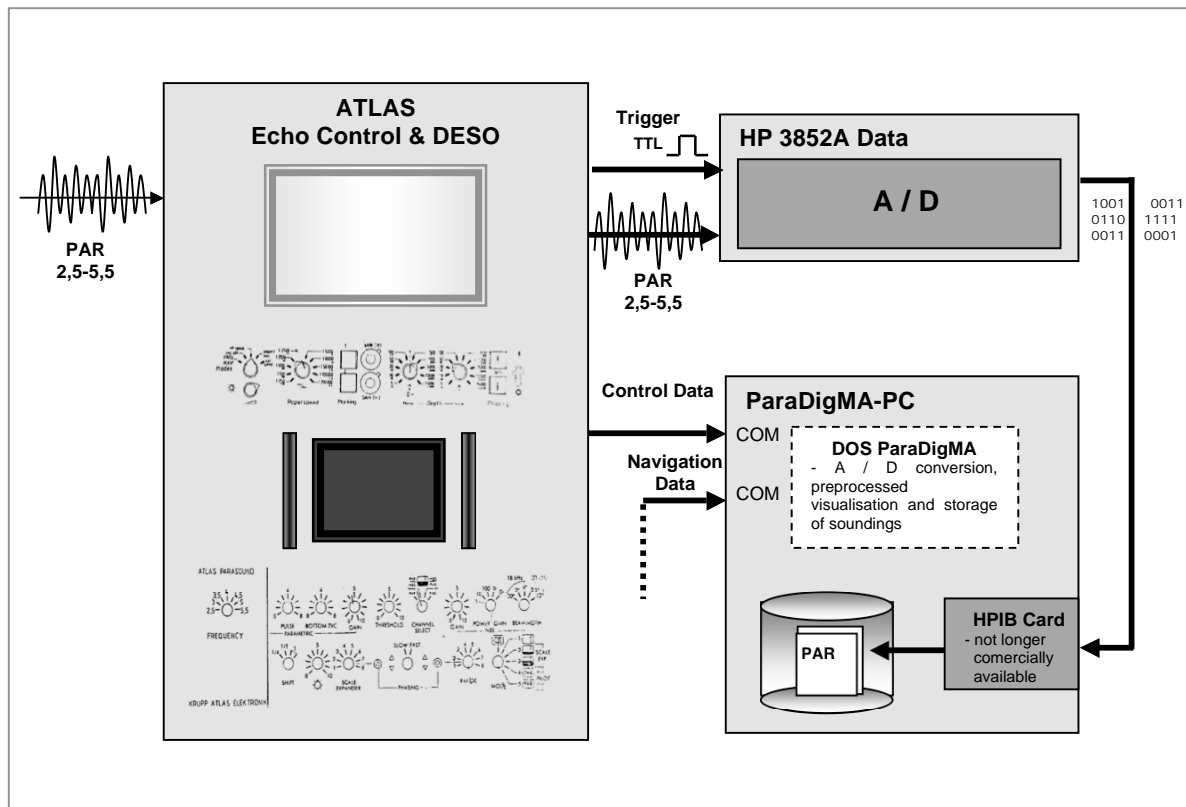

Fig. 5.2.1: Parasound / ParaDigMA system architecture, since 1993 on Polarstern with communication over hardware interfaces

Today the combination of Parasound echosounder DS-2 designed by ATLAS Hydrographic and ParaDigMA has accomplished the step from DOS towards Windows platform and network-capability (Fig. 5.2.2). In cooperation with ATLAS Hydrographic and the Department of Earth Sciences, University of Bremen a new release of the Parasound/ParaDigMA system has been developed in order to adapt the system on modern requirements and thereby provide improved features to survey the physical state of the sea floor along the ship's track and a high level data quality.

The new Windows ParaDigMA is commercially available as PARASTORE 3. It is designed for the ATLAS Parasound DS2 system and does not work automatically with the old System on *Polarstern*.

In spite of the fact that this can only be a temporary solution, we decided to make the Windows version of ParaDigMA available for the old Parasound control as it currently exists on *Polarstern* as well as on *Meteor* and *Sonne*. A main reason for that decision is that in general, DOS-based programmes are restricted to a lot of limitations

concerning memory management, processing in general and network capability, which would make it worthwhile to improve the measurement quality as soon as possible. Another urgent reason still to invest in a temporary adaptation of the new to the old, had been the fact that a special HPIB controller required by the DOS programme is not commercially available anymore. Crashes of the last card might very soon stop any further digital registration.

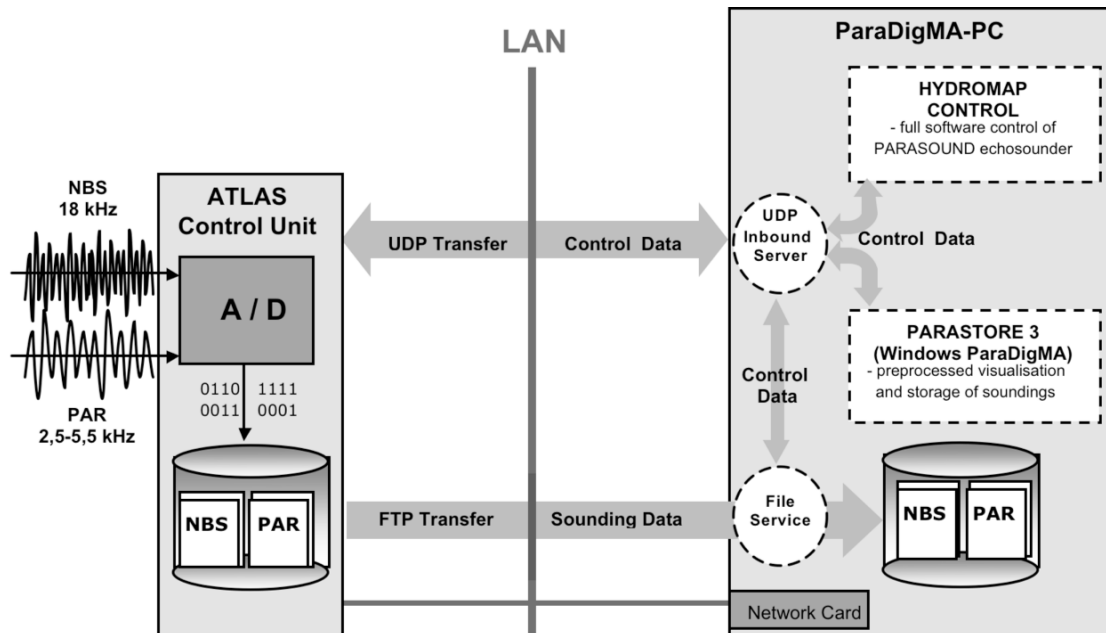

Fig. 5.2.2: System architecture of new ATLAS Parasound DS2 system (2002) with communication over local area network.

For making the new Windows ParaDigMA available for the old Parasound control system, a supplemental interface application had to be developed and in a second step adapted to the vessel's special environment. The DAU-Interface application (DAU = Short name of the old HP 3852 Data Acquisition Unit) simulates the new Parasound control system. On the one hand it communicates with and acquires the data from the old Parasound system like the former DOS software did. On the other hand it provides the data to the Windows ParaDigMA software like the new Parasound DS2 control system would do. Concrete advantages of the Windows platform for Parasound watchkeepers and responsables are the multi-threaded programming structure and the network capability. So, paper jams in the printer do not longer stop the whole registration. The registered data is immediately available now and can be transferred over network to processing computers on any location without stopping the registration. The registration window can be increased up to 400 m without reducing the sampling rate. Finally the improved interactive graphical user interface makes the application more user friendly than before. Also a first step into the direction "Remote PARASOUND" has been done with the installation of remote stations that cannot control the echosounder but visualise online the current soundings on each location with LAN access on the vessel.

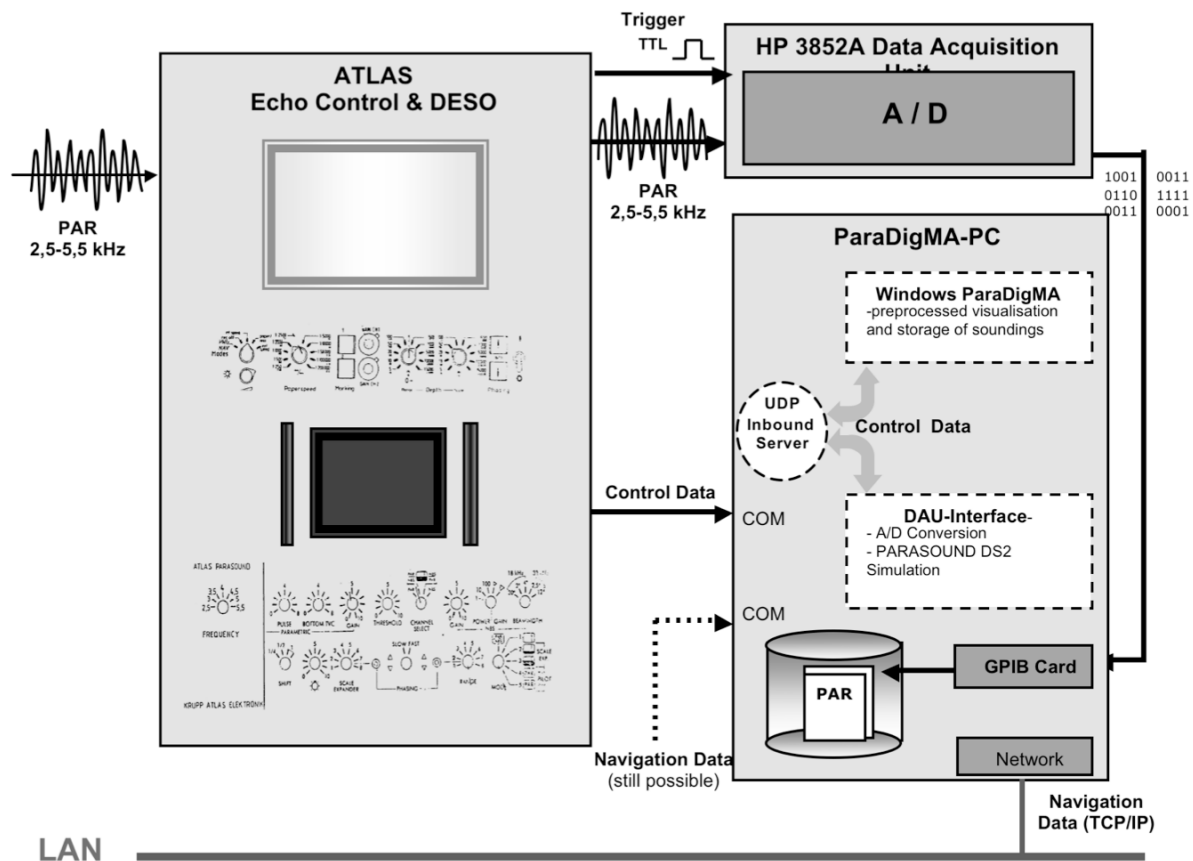

Fig. 5.2.3: Parasound / ParaDigMA system architecture installed on ANT-XXI/1 with communication over hardware interfaces and network capability

Some important features of Windows ParaDigMA are still not available in connection to the old analogue control. The registration of the whole water column which allows a watchkeeping free Parasound operation, is only provided by the Parasound DS2, also the two-channel registration of the 2.5 - 5.5 kHz parametric signal (PAR) and the 18 kHz Narrow Single-Beam signal (NBS), which, in combination with the recording of complete sounding profiles, provides the base for evolving scientific research topics, e.g. gas venting. A further exclusively Parasound DS2 capability is the complete software control and the resulting independency of sensor location, A/D location and control location.

Since the programming and adaptation of the DAU-Interface solution had been finished almost a week before *Polarstern* arrived in Cape Town we still had time for operation tests of several days and for ordinary data registration within the transit area (Fig. 5.2.4). A first data quality control had been done already on this cruise. Nevertheless the collected data will be reviewed a second time at the University of Bremen and AWI.

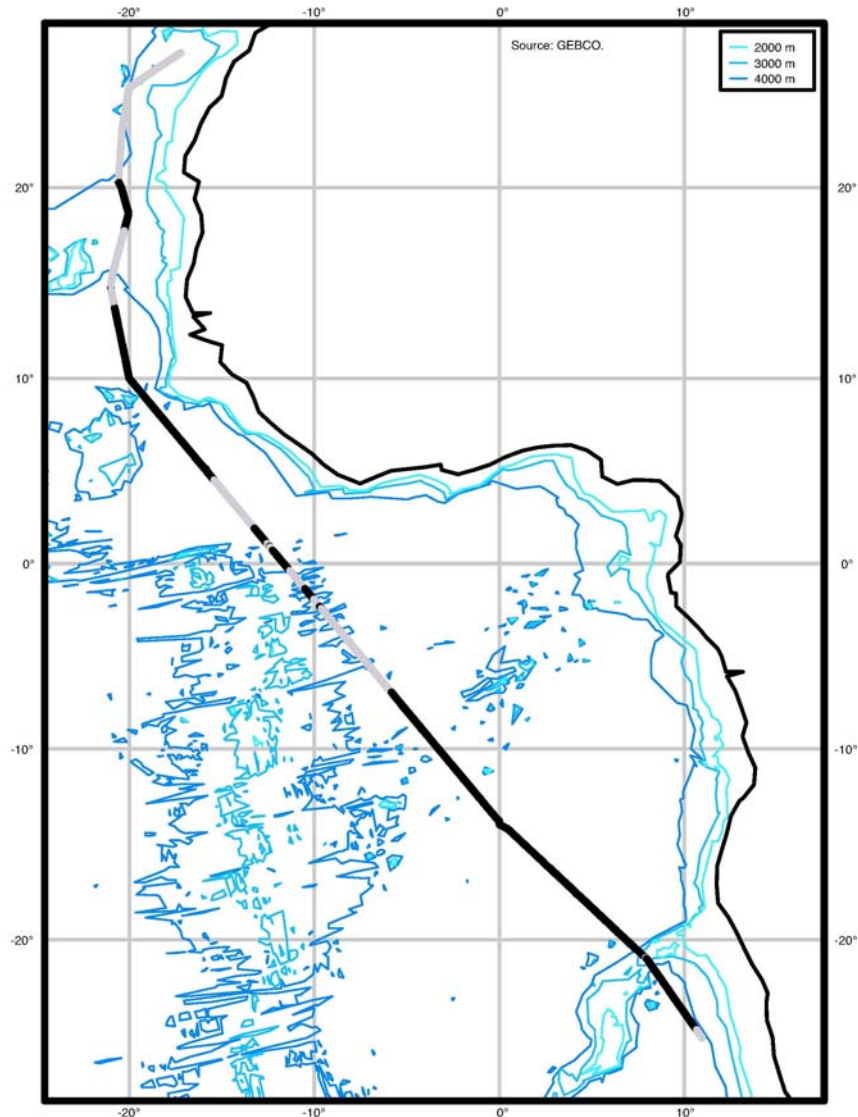

Fig. 5.2.4: Course track during ANT-XXI/1 (grey) and Parasound / ParaDigMA data registration (black)

HYDROSWEEP

The swath bathymetric system HYDROSWEEP of ATLAS Hydrographic is used for mapping the water depth. 59 beams of well known pre-defined angles sample the seafloor. The total swath width is 90°, giving coverage of 2 times the ocean depth. The system operates at a frequency of 15.5 kHz. The system uses a calibration mode to compare depth values of the central and outer beams in order to calculate a mean sound velocity by producing the best fit between both values. Refraction effects on the outer beams are suppressed by this method and minimize residual errors to values smaller than 0.5 % of water depth.

In cooperation between geosciences at University Bremen and AWI (research center of ocean margins RCOM) we collected Hydrosweep data on the cruise. Data quality must be reviewed, because the system was running in test mode after installation of

new software on the cruise between Bremerhaven and Canary Islands. North of Cape Verde Islands we crossed the Cap Timiris Canyon, which was mapped on Meteor-Cruise M58/1 (Fig. 5.2.5). The canyon here still is approximately 100 m deep and more than 1 km broad. The processing of the bathymetric data can be carried out with the public domain software MultiBeam (for Linux, Unix OS) at the university.

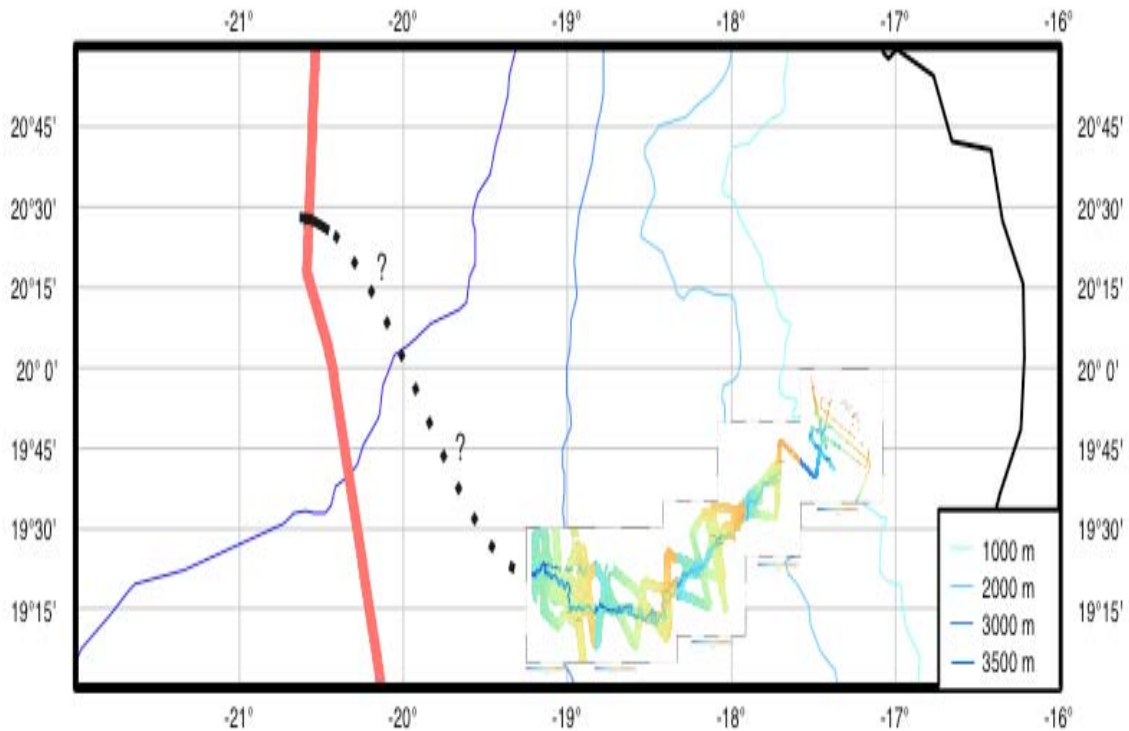

Fig. 5.2.5: Cruise track (thick grey line) crosses Cap Timiris Canyon (black line) at 20°30'N. The area mapped during Meteor-Cruise M58/1 is more to the south.

APPENDIX

**A.1 BETEILIGTE INSTITUTE / PARTICIPATING
INSTITUTES**

A.2 FAHRTTEILNEHMER / PARTICIPANTS

A.3 SCHIFFSBESATZUNG / SHIP'S CREW

A.4 STATIONSLISTE / STATION LIST PS 28

A.1 BETEILIGTE INSTITUTE / PARTICIPATING INSTITUTES ANT-XXI/1

	Adresse / Address	No. of participants
AWI	Alfred-Wegener-Institut für Polar- und Meeresforschung Columbusstraße 27568 Bremerhaven	7
AWI-P	Alfred-Wegener-Institut für Polar- und Meeresforschung Forschungsstelle Potsdam 14401 Potsdam	2
CHYORK	University of York Department of Chemistry York, YO10 5DD UK	2
DWD	Deutscher Wetterdienst Geschäftsbereich Wettervorhersage Seeschiffahrtsberatung Bernhard Nocht Str. 76 20359 Hamburg Germany	2
FIELAX	FIELAX Gesellschaft für wissenschaftliche Datenverarbeitung mbH Schifferstrasse 10-14 27568 Bremerhaven	2
IfM	Institut für Meereskunde Universität Kiel Düsternbrooker Weg 20 24105 Kiel	1
Impres	Impres GmbH Varreler Landstrasse 9 28259 Bremen	1
isitec	ISITEC GmbH Stresemannstr. 46 27570 Bremerhaven	1

	Adresse / Address	No. of participants
IUPB	Universität Bremen Institut für Umweltphysik Otto-Hahn-Allee 1 28359 Bremen	1
IUPH	Universität Heidelberg Institut für Umweltphysik Im Neuenheimer Feld 69120 Heidelberg	1
MPI-M	Max-Planck-Institut für Chemie Postfach 3060 55020 Mainz	2
U Bremen	Universität Bremen FB 5 Geowissenschaften Klagenfurter Str, 28334 Bremen	1
UMIST	University of Manchester Institute of Science and Technology PO Box 88 Manchester M60 1Q UK	1
UNH	University of New Hampshire Institute for the Study of Earth, Oceans, and Space 39 College Road Durham, NH 03824-3525 USA	2
UU	Universität Ulm Abt. Analytische Chemie u. Umweltchemie Albert-Einstein-Allee 11 89081 Ulm	1
UVA	University of Virginia Department of Environmental Science Charlottesville, VA 22904 USA	3

A.2 FAHRTTEILNEHMER / PARTICIPANTS ANT-XXI/1

Name	Vorname First name	Institut Institute
Bayer	Uli	FIELAX
Beninga	Ingo	Impres/AWI
Beyer	Andreas	AWI
Buldt	Klaus	DWD
El Naggar	Saad	AWI
Gebhardt	Sarah	IfM
Gerriets	Andreas	UB
Grünert	Anke	UU
Hopkins	James	CHYORK
Ibrahim Ahmed	Ossama	IUPH
Immler	Franz	AWI
Kahrs	Thomas	FIELAX
Keene	William	UVA
Kerkweg	Astrid	MPI-M
Kuhn	Gerhard	AWI
Lilienthal	Heiko	isitec/AWI
Maben	John	UVA
Niederjasper	Fred	AWI
O'Halloran	Thomas	UVA
Palmer	Carl	CHYORK
Pszenny	Alexander	UNH
Sander	Rolf	MPI-M
Schrems	Otto	AWI
Schulz	Astrid	AWI-P
Tegtmeier	Susann	AWI-P
Wall	Andrew	UNH
Warneke	Thorsten	IUPB
Williams	Paul Ivor	UMIST

A.3 SCHIFFSPERSONAL / SHIP'S CREW ANT-XXI/1

No.	Name		Rank
01.	Domke	Udo	Master
02.	Grundmann	Uwe	1.Offc.
03.	Pluder	Andreas	Ch. Eng.
04.	Peine	Lutz G.	2. Offc.
05.	Spielke	Steffen	2. Offc.
06.	Szepanski	Nico	2. Offc.
07.	Krüger	Klaus Jürgen	Doctor
08.	Koch	Georg	R.Offc.
09.	Delff	Wolfgang	1.Eng.
10.	Kotnik	Herbert	2. Eng.
11.	Ziemann	Olaf	2.Eng.
12.	Baier	Ulrich	FielaxElo
13.	Bretfeld	Holger	FielaxElo
14.	Fröb	Martin	FielaxElo
15.	Gerchow	Peter	FielaxElo
16.	Muhle	Heiko	ElecTech.
17.	Piskorzynski	Andreas	FielaxElo
18.	Loidl	Reiner	Boatsw.
19.	Reise	Lutz	Carpenter
20.	Bäcker	Andreas	A.B.
21.	Bastigkeit	Kai	A.B.
22.	Freitag	Patrick	A.B.
23.	Hagemann	Manfred	A.B.
24.	Pousada Martinez	S.	A.B.
25.	Schmidt	Uwe	A.B.
26.	Vehlow	Ringo	A.B.
27.	Winkler	Michael	A.B.
28.	Preußner	Jörg	Storek.
29.	Elsner	Klaus	Mot-man
30.	Grafe	Jens	Mot-man
31.	Hartmann	Ernst-Uwe	Mot-man
32.	Ipsen	Michael	Mot-man
33.	Voy	Bernd	Mot-man
34.	Haubold	Wolfgang	Cook
35.	Silinski	Frank	Cooksmate
36.	Völske	Thomas	Cooksmate
37.	Jürgens	Monika	1.Stwdess
38.	Wöckener	Martina	Stwdss/KS
39.	Czyborra	Bärbel	2.Stwdess
40.	Gaude	Hans-Jürgen	2.Steward
41.	Huang	Wu-Mei	2.Steward
42.	Möller	Wolfgang	2.Steward
43.	Silinski	Carmen	2.Stwdess
44.	Yu Kwok	Yuen	Laundrym

A. 4 STATION LIST PS 28

Station No.	Date/Time	Position Latitude	Position Longitude	Elevation	Elevation end	Device
PS28/1-track	1993-10-18T08:20	5.422.000	773.000			Measurements along cruise track
PS28/1_2	1993-10-21T09:59	4.573.330	-1.276.670	-4774	-756	Expendable bathythermograph
PS28/1_3	1993-10-21T14:21	4.498.330	-1.388.330	-3786	-756	Expendable bathythermograph
PS28/1_4	1993-10-21T19:00	4.400.000	-1.373.330	-4327	-756	Expendable bathythermograph
PS28/1_5	1993-10-21T23:45	4.403.330	-1.391.670	-5237	-756	Expendable bathythermograph
PS28/1_7	1993-10-22T09:46	4.096.670	-1.426.670	-5284	-756	Expendable bathythermograph
PS28/1_9	1993-10-22T20:50	3.908.330	-1.415.000	-4441	-756	Expendable bathythermograph
PS28/1_10	1993-10-23T03:41	3.800.000	-1.383.330	-4005	-756	Expendable bathythermograph
PS28/1_11	1993-10-23T18:07	3.703.330	-1.400.000	-1683	-756	Expendable bathythermograph
PS28/1_12	1993-10-23T22:58	3.603.330	-1.441.670	-3865	-756	Expendable bathythermograph
PS28/1_13	1993-10-24T04:08	3.501.670	-1.471.670	-3226	-756	Expendable bathythermograph
PS28/1_14	1993-10-24T08:47	3.405.000	-1.521.670	-3857	-752	Expendable bathythermograph
PS28/1_15	1993-10-24T13:26	3.306.670	-1.561.670	-3948	-756	Expendable bathythermograph
PS28/1_16	1993-10-24T18:20	3.205.000	-1.601.670	-4377	-756	Expendable bathythermograph
PS28/1_17	1993-10-24T23:10	3.103.330	-1.640.000	-4371	-756	Expendable bathythermograph
PS28/1_18	1993-10-25T04:00	3.003.330	-1.680.000	-3973	-756	Expendable bathythermograph
PS28/1_19	1993-10-25T08:44	2.903.330	-1.716.670	-3803	-756	Expendable bathythermograph
PS28/1_20	1993-10-26T12:07	2.603.330	-1.886.670	-3358	-756	Expendable bathythermograph
PS28/1_21	1993-10-26T05:15	2.506.670	-1.960.000	-3610	-756	Expendable bathythermograph
PS28/1_22	1993-10-26T11:07	2.403.330	-2.038.330	-3914	-756	Expendable bathythermograph
PS28/1_23	1993-10-27T01:21	2.300.000	-2.095.000	-4258	-756	Expendable bathythermograph
PS28/1_24	1993-10-27T06:08	2.200.000	-2.100.000	-4305	-756	Expendable bathythermograph
PS28/1_25	1993-10-27T10:39	2.106.670	-2.108.330	-4174	-756	Expendable bathythermograph
PS28/1_26	1993-10-27T17:16	2.003.330	-2.118.330	-3779	-756	Expendable bathythermograph
PS28/1_27	1993-10-27T21:47	1.903.330	-2.146.670	-3311	-756	Expendable bathythermograph
PS28/1_28	1993-10-28T03:36	1.783.330	-2.181.670	-3286	-756	Expendable bathythermograph

Station No.	Date/Time	Position Latitude	Position Longitude	Elevation	Elevation end	Device
PS28/1_29	1993-10-28T07:26	1.700.000	-2.205.000	-3288	-756	Expendable bathythermograph
PS28/1_30	1993-10-28T12:10	1.600.000	-2.231.670	-1823	-756	Expendable bathythermograph
PS28/1_31	1993-10-28T16:37	1.500.000	-2.261.670	-3692	-756	Expendable bathythermograph
PS28/1_32	1993-10-28T21:13	1.400.000	-2.288.330	-4281	-756	Expendable bathythermograph
PS28/1_33	1993-10-29T01:33	1.303.330	-2.315.000	-4655	-756	Expendable bathythermograph
PS28/1_34	1993-10-29T06:31	1.201.670	-2.343.330	-5031	-756	Expendable bathythermograph
PS28/1_35	1993-10-29T11:24	1.101.670	-2.370.000	-5181	-756	Expendable bathythermograph
PS28/1_36	1993-10-29T16:59	1.000.000	-2.400.000	-5300	-756	Expendable bathythermograph
PS28/1_37	1993-10-29T23:37	900.000	-2.351.670	-4966	-756	Expendable bathythermograph
PS28/1_41	1993-10-30T11:03	700.000	-2.245.000	-3984	-756	Expendable bathythermograph
PS28/1_42	1993-10-31T11:42	200.000	-2.016.670	-4567	-756	Expendable bathythermograph
PS28/1_43	1993-10-31T16:23	200.000	-1.973.330	-5131	-756	Expendable bathythermograph
PS28/1_44	1993-10-31T22:14	100.000	-1.920.000	-4663	-756	Expendable bathythermograph
PS28/1_45	1993-11-01T03:52	0.00000	-1.866.670	-4144	-756	Expendable bathythermograph
PS28/1_46	1993-11-02T10:21	-0.13330	-1.483.330	-2981	-756	Expendable bathythermograph
PS28/1_47	1993-11-03T10:27	-113.330	-996.670	-4333	-756	Expendable bathythermograph
PS28/1_48	1993-11-04T10:18	-213.330	-480.000	-4788	-756	Expendable bathythermograph
PS28/1_49	1993-11-05T09:41	-315.000	0.53330	-4382	-756	Expendable bathythermograph
PS28/1_50	1993-11-06T08:29	-500.000	563.330	-4765	-756	Expendable bathythermograph
PS28/1_51	1993-11-07T08:29	-600.000	1.015.000	-3079	-756	Expendable bathythermograph
PS28/1_53	1993-11-07T18:25	-800.000	963.330	-4128	-756	Expendable bathythermograph
PS28/1_54	1993-11-07T23:32	-900.000	936.670	-4346	-756	Expendable bathythermograph
PS28/1_55	1993-11-08T04:34	-1.000.000	911.670	-4554	-756	Expendable bathythermograph
PS28/1_56	1993-11-08T13:47	-1.101.670	811.670	-4835	-756	Expendable bathythermograph
PS28/1_57	1993-11-08T21:14	-1.200.000	705.000	-5140	-756	Expendable bathythermograph
PS28/1_58	1993-11-09T14:31	-1.300.000	625.000	-5312	-756	Expendable bathythermograph
PS28/1_59	1993-11-09T19:39	-1.400.000	665.000	-5171	-756	Expendable bathythermograph
PS28/1_60	1993-11-10T12:27	-1.496.670	705.000	-5050	-756	Expendable bathythermograph

Station No.	Date/Time	Position Latitude	Position Longitude	Elevation	Elevation end	Device
PS28/1_61	1993-11-10T05:48	-1.600.000	746.670	-5008	-756	Expendable bathythermograph
PS28/1_62	1993-11-10T12:31	-1.700.000	768.330	-4946	-756	Expendable bathythermograph
PS28/1_63	1993-11-10T17:59	-1.800.000	785.000	-5002	-756	Expendable bathythermograph
PS28/1_64	1993-11-10T23:20	-1.900.000	803.330	-5061	-756	Expendable bathythermograph
PS28/1_65	1993-11-11T04:54	-2.000.000	828.330	-2572	-756	Expendable bathythermograph
PS28/1_66	1993-11-11T11:51	-2.100.000	868.330	-3436	-756	Expendable bathythermograph
PS28/1_67	1993-11-11T17:32	-2.200.000	906.670	-4248	-756	Expendable bathythermograph
PS28/1_68	1993-11-11T23:31	-2.298.330	948.330	-4355	-756	Expendable bathythermograph
PS28/1_69	1993-11-12T05:34	-2.398.330	988.330	-4279	-756	Expendable bathythermograph
PS28/1_70	1993-11-12T11:27	-2.500.000	1.030.000	-4319	-756	Expendable bathythermograph
PS28/1_71	1993-11-12T18:10	-2.596.670	1.000.000	-4600	-756	Expendable bathythermograph
PS28/1_72	1993-11-13T12:06	-2.700.000	963.330	-4816	-756	Expendable bathythermograph
PS28/1_73	1993-11-13T05:41	-2.800.000	926.670	-4967	-756	Expendable bathythermograph
PS28/1_74	1993-11-13T10:23	-2.900.000	891.670	-4980	-756	Expendable bathythermograph
PS28/1_75	1993-11-14T12:02	-3.000.000	868.330	-4984	-756	Expendable bathythermograph
PS28/1_76	1993-11-14T04:47	-3.100.000	871.670	-4916	-756	Expendable bathythermograph
PS28/1_77	1993-11-14T09:22	-3.200.000	871.670	-4823	-756	Expendable bathythermograph
PS28/1_78	1993-11-14T13:27	-3.300.000	861.670	-5026	-756	Expendable bathythermograph
PS28/1_79	1993-11-14T18:48	-3.400.000	850.000	-5091	-756	Expendable bathythermograph
PS28/1_80	1993-11-15T07:19	-3.608.330	825.000	-5041	-632	Expendable bathythermograph
PS28/1_81	1993-11-15T15:05	-3.731.670	813.330	-4879	-756	Expendable bathythermograph
PS28/1_82	1993-11-15T18:48	-3.800.000	803.330	-4997	-756	Expendable bathythermograph
PS28/1_83	1993-11-16T12:23	-3.900.000	791.670	-5347	-756	Expendable bathythermograph
PS28/1_84	1993-11-16T15:12	-4.000.000	795.000	-5020	-756	Expendable bathythermograph
PS28/1_85	1993-11-16T20:07	-4.100.000	806.670	-4931	-756	Expendable bathythermograph
PS28/1_86	1993-11-17T01:02	-4.200.000	820.000	-4580	-756	Expendable bathythermograph
PS28/1_87	1993-11-17T10:31	-4.400.000	850.000	-4583	-756	Expendable bathythermograph
PS28/1_88	1993-11-17T15:41	-4.500.000	865.000	-4563	-756	Expendable bathythermograph

Station No.	Date/Time	Position Latitude	Position Longitude	Elevation	Elevation end	Device
PS28/1_89	1993-11-17T20:45	-4.600.000	880.000	-4513	-756	Expendable bathythermograph
PS28/1_90	1993-11-18T02:11	-4.708.330	896.670	-3726	-756	Expendable bathythermograph
PS28/1_91	1993-11-18T06:41	-4.800.000	910.000	-3861	-756	Expendable bathythermograph
PS28/1_92	1993-11-18T11:24	-4.900.000	920.000	-4317	-756	Expendable bathythermograph
PS28/1_93	1993-11-18T16:32	-5.000.000	876.670	-4363	-756	Expendable bathythermograph
PS28/1_94	1993-11-18T21:43	-5.100.000	830.000	-4205	-756	Expendable bathythermograph
PS28/1_95	1993-11-19T02:59	-5.205.000	850.000	-3784	-756	Expendable bathythermograph
PS28/1_96	1993-11-19T07:17	-5.300.000	883.330	-2883	-756	Expendable bathythermograph
PS28/1_97	1993-11-19T20:38	-5.400.000	911.670	-3526	-756	Expendable bathythermograph
PS28/1_98	1993-11-20T01:13	-5.500.000	916.670	-3483	-760	Expendable bathythermograph
PS28/1_99	1993-11-20T06:45	-5.606.670	920.000	-5226	-758	Expendable bathythermograph
PS28/1_100	1993-11-20T11:04	-5.700.000	916.670	-5417	-756	Expendable bathythermograph
PS28/1_101	1993-11-20T15:33	-5.783.330	915.000	-5177	-756	Expendable bathythermograph
PS28/10572	1993-10-19T10:34	5.150.000	210.000			Radiosonde
PS28/10573	1993-10-20T10:35	4.910.000	-610.000			Radiosonde
PS28/10574	1993-10-20T21:06	4.800.000	-1.000.000			Radiosonde
PS28/10575	1993-10-21T10:31	4.570.000	-1.280.000			Radiosonde
PS28/10576	1993-10-21T14:38	4.500.000	-1.350.000			Radiosonde
PS28/10577	1993-10-21T19:15	4.400.000	-1.380.000			Radiosonde
PS28/10578	1993-10-21T23:38	4.300.000	-1.390.000			Radiosonde
PS28/10579	1993-10-22T05:05	4.200.000	-1.410.000			Radiosonde
PS28/10580	1993-10-22T09:33	4.110.000	-1.430.000			Radiosonde
PS28/10581	1993-10-22T14:52	4.010.000	-1.440.000			Radiosonde
PS28/10582	1993-10-22T21:13	3.900.000	-1.420.000			Radiosonde
PS28/10583	1993-10-23T03:51	3.800.000	-1.390.000			Radiosonde
PS28/10584	1993-10-23T10:22	3.770.000	-1.380.000			Radiosonde
PS28/10585	1993-10-23T18:18	3.710.000	-1.400.000			Radiosonde
PS28/10586	1993-10-23T22:52	3.600.000	-1.440.000			Radiosonde
PS28/10587	1993-10-24T04:26	3.500.000	-1.480.000			Radiosonde
PS28/10588	1993-10-24T09:03	3.400.000	-1.520.000			Radiosonde
PS28/10589	1993-10-24T13:43	3.300.000	-1.560.000			Radiosonde
PS28/10590	1993-10-24T18:32	3.200.000	-1.610.000			Radiosonde
PS28/10591	1993-10-24T23:04	3.110.000	-1.640.000			Radiosonde
PS28/10592	1993-10-25T04:15	3.000.000	-1.680.000			Radiosonde
PS28/10593	1993-10-25T08:56	2.900.000	-1.720.000			Radiosonde
PS28/10594	1993-10-26T00:01	2.610.000	-1.880.000			Radiosonde
PS28/10595	1993-10-26T05:29	2.510.000	-1.960.000			Radiosonde

Station No.	Date/Time	Position Latitude	Position Longitude	Elevation	Elevation end	Device
PS28/10596	1993-10-26T11:22	2.400.000	-2.040.000			Radiosonde
PS28/10597	1993-10-27T01:36	2.300.000	-2.090.000			Radiosonde
PS28/10598	1993-10-27T06:52	2.190.000	-2.100.000			Radiosonde
PS28/10599	1993-10-27T10:31	2.110.000	-2.110.000			Radiosonde
PS28/10600	1993-10-27T17:34	2.000.000	-2.120.000			Radiosonde
PS28/10601	1993-10-27T23:02	1.900.000	-2.150.000			Radiosonde
PS28/10602	1993-10-28T03:45	1.780.000	-2.180.000			Radiosonde
PS28/10603	1993-10-28T07:40	1.700.000	-2.210.000			Radiosonde
PS28/10604	1993-10-28T12:23	1.600.000	-2.230.000			Radiosonde
PS28/10605	1993-10-28T16:51	1.500.000	-2.260.000			Radiosonde
PS28/10606	1993-10-28T21:28	1.400.000	-2.290.000			Radiosonde
PS28/10607	1993-10-29T01:45	1.310.000	-2.310.000			Radiosonde
PS28/10608	1993-10-29T06:43	1.210.000	-2.340.000			Radiosonde
PS28/10609	1993-10-29T11:38	1.100.000	-2.370.000			Radiosonde
PS28/10610	1993-10-29T16:56	1.000.000	-2.400.000			Radiosonde
PS28/10611	1993-10-29T23:52	900.000	-2.350.000			Radiosonde
PS28/10612	1993-10-30T05:45	800.000	-2.300.000			Radiosonde
PS28/10613	1993-10-30T10:31	730.000	-2.250.000			Radiosonde
PS28/10614	1993-10-30T17:31	600.000	-2.190.000			Radiosonde
PS28/10615	1993-10-30T22:56	500.000	-2.140.000			Radiosonde
PS28/10616	1993-10-31T04:40	410.000	-2.080.000			Radiosonde
PS28/10617	1993-10-31T10:17	310.000	-2.030.000			Radiosonde
PS28/10618	1993-10-31T16:36	200.000	-1.980.000			Radiosonde
PS28/10619	1993-10-31T22:10	100.000	-1.920.000			Radiosonde
PS28/10620	1993-11-01T04:04	0.00000	-1.870.000			Radiosonde
PS28/10621	1993-11-01T10:10	-0.20000	-1.850.000			Radiosonde
PS28/10622	1993-11-02T10:08	-100.000	-1.490.000			Radiosonde
PS28/10623	1993-11-03T10:14	-190.000	-1.000.000			Radiosonde
PS28/10624	1993-11-04T10:09	-300.000	-490.000			Radiosonde
PS28/10625	1993-11-05T09:54	-400.000	0.50000			Radiosonde
PS28/10627	1993-11-07T08:25	-600.000	1.020.000			Radiosonde
PS28/10629	1993-11-07T18:38	-800.000	970.000			Radiosonde
PS28/10630	1993-11-07T23:25	-900.000	920.000			Radiosonde
PS28/10631	1993-11-08T04:46	-1.000.000	910.000			Radiosonde
PS28/10632	1993-11-08T13:37	-1.100.000	820.000			Radiosonde
PS28/10633	1993-11-08T21:09	-1.200.000	710.000			Radiosonde
PS28/10634	1993-11-09T10:10	-1.280.000	620.000			Radiosonde
PS28/10635	1993-11-09T14:41	-1.300.000	670.000			Radiosonde
PS28/10636	1993-11-09T19:51	-1.400.000	660.000			Radiosonde
PS28/10637	1993-11-10T00:42	-1.500.000	710.000			Radiosonde
PS28/10638	1993-11-10T05:56	-1.600.000	750.000			Radiosonde
PS28/10640	1993-11-10T18:09	-1.800.000	790.000			Radiosonde
PS28/10641	1993-11-10T23:32	-1.900.000	810.000			Radiosonde
PS28/10642	1993-11-11T05:14	-2.000.000	830.000			Radiosonde
PS28/10643	1993-11-11T12:05	-2.100.000	870.000			Radiosonde

Station No.	Date/Time	Position Latitude	Position Longitude	Elevation	Elevation end	Device
PS28/10644	1993-11-11T17:25	-2.200.000	910.000			Radiosonde
PS28/10645	1993-11-11T23:42	-2.300.000	950.000			Radiosonde
PS28/10646	1993-11-12T05:45	-2.400.000	990.000			Radiosonde
PS28/10647	1993-11-12T11:39	-2.500.000	1.030.000			Radiosonde
PS28/10648	1993-11-12T18:21	-2.600.000	1.000.000			Radiosonde
PS28/10649	1993-11-13T00:18	-2.700.000	970.000			Radiosonde
PS28/10650	1993-11-13T05:55	-2.800.000	930.000			Radiosonde
PS28/10651	1993-11-13T10:14	-2.900.000	890.000			Radiosonde
PS28/10652	1993-11-14T00:14	-3.000.000	870.000			Radiosonde
PS28/10653	1993-11-14T04:57	-3.100.000	870.000			Radiosonde
PS28/10654	1993-11-14T10:07	-3.210.000	870.000			Radiosonde
PS28/10656	1993-11-14T19:00	-3.400.000	850.000			Radiosonde
PS28/10657	1993-11-15T07:31	-3.600.000	830.000			Radiosonde
PS28/10658	1993-11-15T13:25	-3.700.000	820.000			Radiosonde
PS28/10659	1993-11-15T18:53	-3.800.000	810.000			Radiosonde
PS28/10660	1993-11-16T00:28	-3.900.000	790.000			Radiosonde
PS28/10661	1993-11-16T10:30	-3.950.000	790.000			Radiosonde
PS28/10662	1993-11-16T15:29	-4.000.000	800.000			Radiosonde
PS28/10663	1993-11-16T20:12	-4.100.000	810.000			Radiosonde
PS28/10664	1993-11-17T01:06	-4.200.000	820.000			Radiosonde
PS28/10665	1993-11-17T06:01	-4.300.000	840.000			Radiosonde
PS28/10666	1993-11-17T10:27	-4.300.000	850.000			Radiosonde
PS28/10667	1993-11-17T15:36	-4.500.000	870.000			Radiosonde
PS28/10668	1993-11-17T20:49	-4.600.000	880.000			Radiosonde
PS28/10669	1993-11-18T02:15	-4.710.000	900.000			Radiosonde
PS28/10670	1993-11-18T06:45	-4.800.000	910.000			Radiosonde
PS28/10671	1993-11-18T11:29	-4.900.000	920.000			Radiosonde
PS28/10672	1993-11-18T16:38	-5.000.000	880.000			Radiosonde
PS28/10673	1993-11-18T21:48	-5.100.000	830.000			Radiosonde
PS28/10674	1993-11-19T03:03	-5.200.000	850.000			Radiosonde
PS28/10675	1993-11-19T07:20	-5.300.000	860.000			Radiosonde
PS28/10677	1993-11-20T01:16	-5.500.000	920.000			Radiosonde
PS28/10678	1993-11-20T06:49	-5.600.000	920.000			Radiosonde
PS28/10679	1993-11-20T11:09	-5.700.000	920.000			Radiosonde
PS28/10680	1993-11-20T17:41	-5.780.000	920.000			Radiosonde
PS28/10682	1993-11-22T10:21	-5.010.000	1.260.000			Radiosonde
PS28/10683	1993-11-23T10:11	-4.760.000	1.360.000			Radiosonde
PS28/10684	1993-11-24T10:16	-4.410.000	1.490.000			Radiosonde
PS28/10685	1993-11-25T10:38	-4.090.000	1.590.000			Radiosonde
PS28/11298	1993-10-19T15:00	5.043.000	-0.44000			Radiosonde
PS28/11299	1993-10-20T14:30	4.860.000	-790.000			Radiosonde
PS28/11300	1993-10-23T12:55	3.740.000	-1.345.000			Radiosonde
PS28/11301	1993-10-24T10:58	3.335.000	-1.525.000			Radiosonde
PS28/11302	1993-10-25T21:10	2.634.000	-1.828.000			Radiosonde
PS28/11303	1993-10-27T13:48	2.033.000	-2.170.000			Radiosonde

Station No.	Date/Time	Position Latitude	Position Longitude	Elevation	Elevation end	Device
PS28/11304	1993-10-28T21:00	1.404.000	-2.252.000			Radiosonde
PS28/11305	1993-10-29T13:55	1.050.000	-2.380.000			Radiosonde
PS28/11306	1993-10-30T13:20	670.000	-2.220.000			Radiosonde
PS28/11307	1993-10-31T13:46	260.000	-2.000.000			Radiosonde
PS28/11308	1993-11-01T14:35	-0.20000	-1.850.000			Radiosonde
PS28/11309	1993-11-02T13:30	-110.000	-1.410.000			Radiosonde
PS28/11310	1993-11-03T13:15	-210.000	-940.000			Radiosonde
PS28/11311	1993-11-04T13:20	-310.000	-410.000			Radiosonde
PS28/11312	1993-11-05T13:18	-410.000	130.000			Radiosonde
PS28/11313	1993-11-06T09:03	-500.000	570.000			Radiosonde
PS28/11314	1993-11-07T13:25	-710.000	990.000			Radiosonde
PS28/11315	1993-11-08T12:48	-1.070.000	840.000			Radiosonde
PS28/11316	1993-11-09T12:22	-1.260.000	615.000			Radiosonde
PS28/11317	1993-11-10T12:30	-1.700.000	760.000			Radiosonde
PS28/11318	1993-11-11T12:33	-2.110.000	870.000			Radiosonde
PS28/11319	1993-11-12T12:14	-2.510.000	1.030.000			Radiosonde
PS28/11320	1993-11-13T12:27	-2.940.000	870.000			Radiosonde
PS28/11321	1993-11-14T13:45	-3.290.000	860.000			Radiosonde
PS28/11322	1993-11-15T12:29	-3.690.000	810.000			Radiosonde
PS28/11323	1993-11-16T10:27	-3.950.000	790.000			Radiosonde
PS28/11324	1993-11-17T13:43	-4.470.000	860.000			Radiosonde
PS28/11325	1993-11-18T08:40	-4.840.000	910.000			Radiosonde
PS28/11326	1993-11-19T20:44	-5.400.000	910.000			Radiosonde
PS28/11327	1993-11-20T08:24	-5.780.000	912.000			Radiosonde
PS28/11328	1993-11-21T10:30	-5.460.000	1.070.000			Radiosonde
PS28/11329	1993-11-23T18:55	-4.630.000	1.410.000			Radiosonde
PS28/11330	1993-11-24T18:39	-4.280.000	1.520.000			Radiosonde
PS28/11647	1993-10-22T12:55	4.020.000	-1.422.000			Radiosonde

Die "**Berichte zur Polar- und Meeresforschung**" (ISSN 1866-3192) werden beginnend mit dem Heft Nr. 569 (2008) ausschließlich elektronisch als Open-Access-Publikation herausgegeben. Ein Verzeichnis aller Hefte einschließlich der Druckausgaben (Heft 377-568) sowie der früheren "**Berichte zur Polarforschung**" (Heft 1-376, von 1982 bis 2000) befindet sich im Internet in der Ablage des electronic Information Center des AWI (**ePIC**) unter der URL <http://epic.awi.de>. Durch Auswahl "Reports on Polar- and Marine Research" auf der rechten Seite des Fensters wird eine Liste der Publikationen in alphabetischer Reihenfolge (nach Autoren) innerhalb der absteigenden chronologischen Reihenfolge der Jahrgänge erzeugt.

To generate a list of all Reports past issues, use the following URL: <http://epic.awi.de> and select the right frame to browse "Reports on Polar and Marine Research". A chronological list in declining order, author names alphabetical, will be produced, and pdf-icons shown for open access download.

Verzeichnis der zuletzt erschienenen Hefte:

Heft-Nr. 593/2009 — "The Campaign MELTEX with Research Aircraft 'POLAR 5' in the Arctic in 2008", edited by Gerit Birnbaum, Wolfgang Dierking, Jörg Hartmann, Christof Lüpkes, André Ehrlich, Thomas Garbrecht, and Manuel Sellmann

Heft-Nr. 594/2009 — "The Expedition of the Research Vessel 'Polarstern' to the Antarctic in 2008 (ANT-XXV/1)", edited by Gerhard Kattner and Boris Koch

Heft-Nr. 595/2009 — "The Expedition of the Research Vessel 'Polarstern' to the Antarctic in 2008/2009 (ANT-XXV/2)", edited by Olaf Boebel

Heft-Nr. 596/2009 — "Crustal evolution of the submarine plateaux of New Zealand and their tectonic reconstruction based on crustal balancing", by Jan Werner Gerhard Grobys

Heft-Nr. 597/2009 — "The Expedition of the Research Vessel 'Polarstern' to the Arctic in 2008 (ARK-XXIII/3)", edited by Wilfried Jokat

Heft-Nr. 598/2009 — "The Expedition of the Research Vessel 'Pelagia' to the Natal Basin and the Mozambique Ridge in 2009 (Project AISTEK III)", edited by Wilfried Jokat

Heft-Nr. 599/2009 — "The Expedition of the Research Vessel 'Maria S. Merian' to the Labrador Sea in 2009 (MSM12/2)", edited by Gabriele Uenzelmann-Neben

Heft-Nr. 600/2009 — "Russian-German Cooperation SYSTEM LAPTEV SEA: The Expedition Lena 2009, edited by Julia Boike, Katya Abramova, Dmitry Yu. Bolshiyarov, Mikhail N. Grigoriev, Ulrike Herzsuh, Gerhard Kattner, Christian Knoblauch, Lars Kutzbach, Gesine Mollenhauer, Waldemar Schneider

Heft-Nr. 601/2009 — "Analyse von Bathymetrie und akustischer Rückstreuung verschiedener Fächersonar- und Sedimentecholot-Systeme zur Charakterisierung und Klassifizierung des Meeresbodens am Gakkel-Rücken, Arktischer Ozean", by Jörn Hatzky

Heft-Nr. 602/2009 — "Cumacea (Crustacea; Peracarida) of the Antarctic shelf – diversity, biogeography, and phylogeny", by Peter Rehm

Heft-Nr. 603/2010 — "The Expedition of the Research Vessel 'Polarstern' to the Antarctic in 2009 (ANT-XXV/5)", edited by Walter Zenk and Saad El Naggar

Heft-Nr. 604/2010 — "The Expedition of the Research Vessel 'Polarstern' to the Antarctic in 2007/2008 (ANT-XXIV/2)", edited by Ulrich Bathmann

Heft-Nr. 605/2010 — "The Expedition of the Research Vessel 'Polarstern' to the Antarctic in 2003 (ANT-XXI/1)", edited by Otto Schrems