

## RESEARCH ARTICLE

# Overview of the MOSAiC expedition: Ecosystem

Allison A. Fong<sup>1</sup> , Clara J. M. Hoppe<sup>1,\*</sup> , Nicole Aberle<sup>2,3</sup> , Carin J. Ashjian<sup>4</sup> , Philipp Assmy<sup>5</sup> , Youcheng Bai<sup>6</sup> , Dorothee C. E. Bakker<sup>7</sup> , John P. Balmonte<sup>8,9</sup> , Kevin R. Barry<sup>10</sup> , Stefan Bertilsson<sup>11</sup> , William Boulton<sup>12</sup> , Jeff Bowman<sup>13</sup> , Deborah Bozzato<sup>14</sup> , Gunnar Bratbak<sup>15</sup> , Moritz Buck<sup>11</sup> , Robert G. Campbell<sup>16</sup> , Giulia Castellani<sup>1,5</sup> , Emelia J. Chamberlain<sup>13</sup> , Jianfang Chen<sup>6</sup> , Melissa Chierici<sup>17</sup> , Astrid Cornils<sup>1</sup> , Jessie M. Creamean<sup>10</sup> , Ellen Damm<sup>18</sup> , Klaus Dethloff<sup>18</sup> , Elise S. Droste<sup>19,20</sup> , Oliver Ebenhöf<sup>21</sup> , Sarah L. Eggers<sup>1,22</sup> , Anja Engel<sup>23</sup> , Hauke Flores<sup>1</sup> , Agneta Fransson<sup>5</sup> , Stephan Frickenhaus<sup>1,24</sup> , Jessie Gardner<sup>25</sup> , Cecilia E. Gelfman<sup>16</sup> , Mats A. Granskog<sup>5</sup> , Martin Graeve<sup>1</sup> , Charlotte Havermans<sup>1</sup> , Céline Heuzé<sup>26</sup> , Nicole Hildebrandt<sup>27,28</sup> , Thomas C. J. Hill<sup>10</sup> , Mario Hoppema<sup>1</sup> , Antonia Immerz<sup>1</sup> , Haiyan Jin<sup>6</sup> , Boris P. Koch<sup>1</sup> , Xianyu Kong<sup>1</sup> , Alexandra Kraberg<sup>1</sup> , Musheng Lan<sup>29</sup> , Benjamin A. Lange<sup>30,31</sup> , Aud Larsen<sup>32</sup> , Benoit Lebreton<sup>33</sup> , Eva Leu<sup>34</sup> , Brice Loose<sup>16</sup> , Wieslaw Maslowski<sup>35</sup> , Camille Mavis<sup>10</sup> , Katja Metfies<sup>1</sup> , Thomas Mock<sup>7</sup> , Oliver Müller<sup>15</sup> , Marcel Nicolaus<sup>1</sup> , Barbara Niehoff<sup>1</sup> , Daiki Nomura<sup>36</sup> , Eva-Maria Nöthig<sup>1</sup> , Marc Oggier<sup>37</sup> , Ellen Oldenburg<sup>21</sup> , Lasse Mork Olsen<sup>38</sup> , Ilka Peeken<sup>1</sup> , Donald K. Perovich<sup>39</sup> , Ovidiu Popa<sup>21</sup> , Benjamin Rabe<sup>1</sup> , Jian Ren<sup>6</sup> , Markus Rex<sup>18,40</sup> , Annette Rinke<sup>18</sup> , Sebastian Rokitta<sup>1</sup> , Björn Rost<sup>1,41</sup> , Serdar Sakinan<sup>42</sup> , Evgenii Salganik<sup>5</sup> , Fokje L. Schaafsma<sup>43</sup> , Hendrik Schäfer<sup>44</sup> , Katrin Schmidt<sup>45</sup> , Katelynne M. Shoemaker<sup>16</sup> , Matthew D. Shupe<sup>46,47</sup> , Pauline Snoeijis-Leijonmalm<sup>22</sup> , Jacqueline Stefels<sup>14</sup> , Anders Svenson<sup>48</sup> , Ran Tao<sup>1</sup> , Sinhué Torres-Valdés<sup>1</sup> , Anders Torstensson<sup>22</sup> , Andrew Toseland<sup>7</sup> , Adam Ulfso<sup>49</sup> , Maria A. Van Leeuwe<sup>14</sup> , Martina Vortkamp<sup>1</sup> , Alison L. Webb<sup>44</sup> , Yanpei Zhuang<sup>6</sup> , and Rolf R. Gradinger<sup>25</sup> 

<sup>1</sup> Alfred-Wegener-Institut Helmholtz-Zentrum für Polar- und Meeresforschung, Bremerhaven, Germany

<sup>2</sup> Department of Biology, Norwegian University of Science and Technology (NTNU), Trondheim, Norway

<sup>3</sup> Institute of Marine Ecosystem and Fishery Science (IMF), Universität Hamburg, Hamburg, Germany

<sup>4</sup> Woods Hole Oceanographic Institution, Woods Hole, MA, USA

<sup>5</sup> Norwegian Polar Institute, Fram Centre, Tromsø, Norway

<sup>6</sup> Key Laboratory of Marine Ecosystem Dynamics, Second Institute of Oceanography, Ministry of Natural Resources, Hangzhou, China

<sup>7</sup> School of Environmental Sciences, University of East Anglia, Norwich, UK

<sup>8</sup> Current address: Department of Earth and Environmental Sciences, Lehigh University, Bethlehem, PA, USA

<sup>9</sup> Previous address: Department of Ecology, Environment and Plant Sciences, Stockholm University, Stockholm, Sweden

<sup>10</sup> Department of Atmospheric Science, Colorado State University, Fort Collins, CO, USA

<sup>11</sup> Department of Aquatic Sciences and Assessment, Swedish University of Agricultural Sciences, Uppsala, Sweden

<sup>12</sup> School of Computing Sciences, University of East Anglia, Norwich, UK

<sup>13</sup> Scripps Institution of Oceanography, University of California, San Diego, CA, USA

<sup>14</sup> Groningen Institute for Evolutionary Life Sciences (GELIFES), University of Groningen, Groningen, the Netherlands

<sup>15</sup> Department of Biological Sciences, University of Bergen, Bergen, Norway

<sup>16</sup> Graduate School of Oceanography, University of Rhode Island, Narragansett, RI, USA

<sup>17</sup> Institute of Marine Research, Tromsø, Norway

<sup>18</sup> Alfred-Wegener-Institut Helmholtz-Zentrum für Polar- und Meeresforschung, Potsdam, Germany

<sup>19</sup> Current address: Alfred-Wegener-Institut Helmholtz-Zentrum für Polar- und Meeresforschung, Bremerhaven, Germany

<sup>20</sup> Previous address: School of Environmental Sciences, Centre for Ocean and Atmospheric Sciences, University of East Anglia, Norwich, UK

<sup>21</sup> Institute of Quantitative and Theoretical Biology, Heinrich-Heine University Düsseldorf, Düsseldorf, Germany

<sup>22</sup> Department of Ecology, Environment and Plant Sciences, Stockholm University, Stockholm, Sweden

<sup>23</sup> GEOMAR Helmholtz Centre for Ocean Research, Kiel, Germany

<sup>24</sup> Centre for Industrial Mathematics, University of Bremen, Bremen, Germany

<sup>25</sup> UiT The Arctic University of Norway, Tromsø, Norway

<sup>26</sup> Department of Earth Sciences, University of Gothenburg, Gothenburg, Sweden

<sup>27</sup> Current address: AquaEcology GmbH & Co. KG, Oldenburg, Germany

<sup>28</sup> Previous address: Alfred-Wegener-Institut Helmholtz-Zentrum für Polar- und Meeresforschung, Bremerhaven, Germany

<sup>29</sup> Polar Research Institute of China, Shanghai, China

<sup>30</sup> Current address: Norwegian Geotechnical Institute, Oslo, Norway

<sup>31</sup> Previous address: Norwegian Polar Institute, Fram Centre, Tromsø, Norway

<sup>32</sup> NORCE Norwegian Research Centre, Bergen, Norway

<sup>33</sup> Joint Research Unit Littoral, Environment and Societies (CNRS—University of La Rochelle), La Rochelle, France

<sup>34</sup> Akvaplan-niva, Tromsø, Norway

<sup>35</sup> Naval Postgraduate School, Monterey, CA, USA

<sup>36</sup> Hokkaido University, Hakodate, Japan

<sup>37</sup> International Arctic Research Center, University of Alaska Fairbanks, Fairbanks, AK, USA

<sup>38</sup> Department of Bioscience, University of Bergen, Bergen, Norway

<sup>39</sup> Dartmouth College, Hanover, NH, USA

<sup>40</sup> University of Potsdam, Potsdam, Germany

<sup>41</sup> Faculty of Biology/Chemistry, University of Bremen, Bremen, Germany

<sup>42</sup> Wageningen Marine Research, IJmuiden, the Netherlands

<sup>43</sup> Wageningen Marine Research, Den Helder, the Netherlands

<sup>44</sup> School of Life Sciences, University of Warwick, Coventry, UK

<sup>45</sup> School of Geography, Earth and Environmental Sciences, University of Plymouth, Plymouth, UK

<sup>46</sup> Cooperative Institute for Research in Environmental Sciences, University of Colorado Boulder, Boulder, CO, USA

<sup>47</sup> NOAA Physical Sciences Laboratory, Boulder, CO, USA

<sup>48</sup> Swedish University of Agricultural Sciences, Lysekil, Sweden

<sup>49</sup> Department of Marine Sciences, University of Gothenburg, Gothenburg, Sweden

\* Corresponding author:  
Email: [clara.hoppe@awi.de](mailto:clara.hoppe@awi.de)

The international and interdisciplinary sea-ice drift expedition “The Multidisciplinary drifting Observatory for the Study of Arctic Climate” (MOSAiC) was conducted from October 2019 to September 2020. The aim of MOSAiC was to study the interconnected physical, chemical, and biological characteristics and processes from the atmosphere to the deep sea of the central Arctic system. The ecosystem team addressed current knowledge gaps and explored unknown biological properties over a complete seasonal cycle focusing on three major research areas: biodiversity, biogeochemical cycles, and linkages to the environment. In addition to the measurements of core properties along a complete seasonal cycle, dedicated projects covered specific processes and habitats, or organisms on higher taxonomic or temporal resolution in specific time windows. A wide range of sampling instruments and approaches, including sea-ice coring, lead sampling with pumps, rosette-based water sampling, plankton nets, remotely operated vehicles, and acoustic buoys, was applied to address the science objectives. Further, a broad range of process-related measurements to address, for example, productivity patterns, seasonal migrations, and diversity shifts, were made both in situ and onboard RV *Polarstern*. This article provides a detailed overview of the sampling approaches used to address the three main science objectives. It highlights the core sampling program and provides examples of habitat- or process-specific sampling. The initial results presented include high biological activities in wintertime and the discovery of biological hotspots in underexplored habitats. The unique interconnectivity of the coordinated sampling efforts also revealed insights into cross-disciplinary interactions like the impact of biota on Arctic cloud formation. This overview further presents both lessons learned from conducting such a demanding field campaign and an outlook on spin-off projects to be conducted over the next years.

**Keywords:** Arctic Ocean, Sea ice, Seasonal, Ecosystem dynamics

## 1. Introduction

### 1.1. Motivation

The Multidisciplinary drifting Observatory for the Study of Arctic Climate (MOSAiC) expedition provided unique scientific opportunities to understand the interlinked physical, chemical, and biological systems in the central Arctic Ocean at a fundamental level. The science program, shaped over nearly a decade, provides a foundation to create new and important knowledge regarding the functioning of the Arctic marine ecosystem within the context of the coupled Arctic climate system. Five closely cooperating science teams were formed to develop and execute the integrated science plan, focusing on atmosphere, sea ice, ocean, ecosystem, and biogeochemistry. This article provides an overview of the multiple facets of the ecosystem-related research to highlight the interlinked research activities at multiple trophic levels in relation to the environment. Targeted science questions by the MOSAiC ecosystem team (termed ECO team hereafter) were broad, ranging from microbes to fish and focused on biodiversity and ecosystem functioning (including, e.g., carbon and nutrient cycling). Within the ECO team, a total of 25 institutions across 15 nations contributed to generating the field observations and measurements as part of the research program. Similar overviews are available for other MOSAiC research topics, currently for sea-ice physics, physical oceanography, and various aspects of the atmosphere (Nicolaus et al., 2022b; Rabe et al., 2022; Shupe et al., 2022), while an overview of biogeochemical research not covered in this article will be forthcoming. The coordinated ecological research also included biogeochemical variables (e.g., macronutrient and dissolved organic carbon concentrations, seawater, and sea-ice carbonate chemistry) due to their close links to ecosystem processes.

The integrated ecological observations and knowledge generated by the ECO team were aimed specifically at understanding seasonally resolved processes on different temporal and spatial scales. Such an understanding is critical for developing predictions related to climate change impacts on the Arctic system, including alterations to ecosystem structure and functioning (Intergovernmental Panel on Climate Change [IPCC], 2023). While the research is ongoing, new projects are emerging based on insights, data, and collaborations.

Section 1 of this article outlines the main ecological research objectives addressed by the MOSAiC ECO team, followed in the second section by a more detailed description of the scientific approaches and methods being used. Collected data and major achievements are provided in Section 3 to illustrate which topics will be covered in forthcoming peer-reviewed publications. Lastly, Section 4 provides insights into challenges and “lessons learned” when planning such a yearlong expedition and points toward some of the expected impacts on our understanding of the Arctic marine ecosystems that could arise from the acquired knowledge over the years to come.

### 1.2. The central Arctic marine ecosystem and its links to the environment

The Arctic Ocean harbors unique and diverse biological communities in all available habitats: sea ice, snow, meltwater, seawater, atmosphere, and sediments. Although the Arctic Ocean was once considered a relatively species-poor region with limited biological activity, research in recent decades has revised this paradigm (Bluhm et al., 2011). For example, biodiversity is now considered high in all habitats and substantial biological activity occurs year-round, including in the winter season (Berge et al., 2015; Hobbs

et al., 2020). Furthermore, the Arctic marine ecosystem cannot easily be generalized due to the particularly high spatiotemporal variability in biological, chemical, and physical processes (Bluhm et al., 2015). Arctic marine ecosystems have regionally varying complex community structures and activity patterns, largely driven by differences in abiotic factors like water temperature, depth, salinity, light, inorganic nutrients, and sea-ice properties (Bluhm et al., 2015; Balmonte et al., 2018; Bluhm et al., 2018; Polyakov et al., 2020; Ershova et al., 2021; Clement Kinney et al., 2023). Other efforts to explore ecosystem-level research in the central Arctic include the SHEBA expedition (e.g., Ashjian et al., 2003; Sherr et al., 2003), the Circumpolar Flaw Lead study (Barber et al., 2015), the N-ICE2015 campaign (Assmy et al., 2017; Granskog et al., 2018), the Synoptic Arctic Survey (Snoeijs-Leijonmalm et al., 2022), the Tara Arctic project (Royo-Llonch et al., 2021; Ibarbalz et al., 2023), and the Russian ice drift studies (Melnikov, 1980) with complementary studies conducted on Arctic shelves (e.g., the CASES overwintering expedition; Fortier and Cochran, 2008). These efforts made evident that a minimum of three different regional regimes need to be distinguished for the Arctic—the shelves, shelf breaks, and the deep basins (Carmack and Wassmann, 2006; Wassmann et al., 2020).

Despite these numerous valuable previous efforts, the seasonal cycle in the central Arctic remains understudied because the region is difficult to access in winter with thick and extensive sea-ice cover and harsh conditions for field work. Consequently, gains in knowledge are needed in order to assess not only the functioning of the marine ecosystem in the central basin but also its connectivity with and dependency on processes of the inflow, interior, and outflow shelves (Carmack and Wassmann, 2006). Given the large diversity of marine organisms in the central Arctic, ecosystem dynamics over the annual cycle drive marine biogeochemical cycles of various elements that are important in the Earth system (Falkowski et al., 2000). Remote sensing by satellites provides unique opportunities for pan-Arctic and regional observations, its application for biological properties is however limited by the ice-covered, seasonally dark, and often cloud-covered Arctic (Babin et al., 2015). New comprehensive time series data are needed to support and enhance ecological models for Arctic seas (e.g., Zhang et al., 2010; Slagstad et al., 2011; Popova et al., 2012), as well as construct numerical models and test mechanistic hypotheses within the context of Earth System Models (e.g., CMIP5 and CMIP6 for the IPCC AR5 and AR6, respectively; IPCC, 2023). Representations of the marine ecosystem are lacking or less advanced than other components of the Earth system within large-scale models. Therefore, MOSAiC research can provide a critically needed evaluation of the current state of the Arctic marine ecosystem, required to improve our understanding of basic biological processes and ecosystem components and thus to enhance predictions of future system status.

The central deep Arctic Ocean is divided into four abyssal plains separated by the Lomonosov, Gakkel, and Alpha ridges. Even so, the upper water column (approximately 100 m) is contiguous with two major ice drift and surface

ocean circulation patterns: the Transpolar Drift (TPD) system and the Beaufort Gyre, both driven mainly by wind. The MOSAiC field campaign was established on a sea-ice floe at the Siberian edge of the Amundsen Basin (**Figure 1**), close to the origin of the TPD. During the campaign, the floe drifted in the TPD across the central Arctic toward Fram Strait. Details regarding the sea-ice conditions during MOSAiC are provided by Krumpfen et al. (2020) and Nicolaus et al. (2022b). The hydrography in the central Arctic Ocean is characterized by a strong, permanent vertical salinity gradient (halocline). The upper surface mixed layer in the Amundsen Basin is characterized by low salinity and largely cold waters, being affected by river discharge, ice melt/freezing processes, and Pacific inflow inside the TPD (Jones et al., 2008; Rabe et al., 2022; Rudels and Carmack, 2022; Schulz et al., 2024). South of the Amundsen Basin, as separated by the Gakkel ridge, surface waters of the Nansen Basin (**Figure 1**) are less influenced by the TPD. Here surface waters carry a stronger signal of Atlantic-sourced water masses (Schulz et al., 2024). Below the surface mixed layer are warmer and more saline waters of Atlantic origin of several hundred meter thickness (Timmermans and Marshall, 2020). The core of the Atlantic Water is warmest and saltiest north of Svalbard and close to the Barents-Kara Sea slope. In addition, modeling studies suggest that Atlantic water can advect biomass from phytoplankton blooms developed in open waters upstream under the sea ice into the eastern Arctic (Clement Kinney et al., 2023) and may have a stronger impact on biomass dynamics than local production (Vernet et al., 2019). The Atlantic water is modified once it enters the basins and circulates around the Arctic, mainly along the shelf slopes as a deep circulation loop (Rudels and Carmack, 2022); over time it becomes colder and fresher and subducts deeper in the water column. The influence and distribution of these major water sources (i.e., TPD- vs. Atlantic-influenced) on the central Arctic Ocean depends on circulation dynamics, which control the proportion, layering, and mixing of different source waters and their respective nutrient inventories. In surface waters of the central Arctic, nutrient concentrations are variable, but low relative to the Arctic shelf regions and deeper water masses (Bluhm et al., 2015; Randelhoff et al., 2020), where the inflow of Atlantic and Pacific waters carry higher nutrient concentrations and unique nutrient signatures.

The strong vertical gradients in nutrient concentrations and factors such as irradiance and other ocean physico-chemical variables structure the pelagic realm. Highly diverse communities of phytoplankton and sea-ice algae (Poulin et al., 2011) contribute to the primary production in the central Arctic (Gosselin et al., 1997; Wiedmann et al., 2020). Both sea-ice and pelagic algae have developed several successful overwintering strategies to overcome months without sufficient light for photosynthesis (Johnsen et al., 2020) and rapidly utilize the light returning after the polar night (Kvernvik et al., 2018; Hoppe, 2022). Still, the overwintering strategies and modes of nutrition of several key groups and species remain poorly understood. Also, lower trophic herbivores and omnivores,

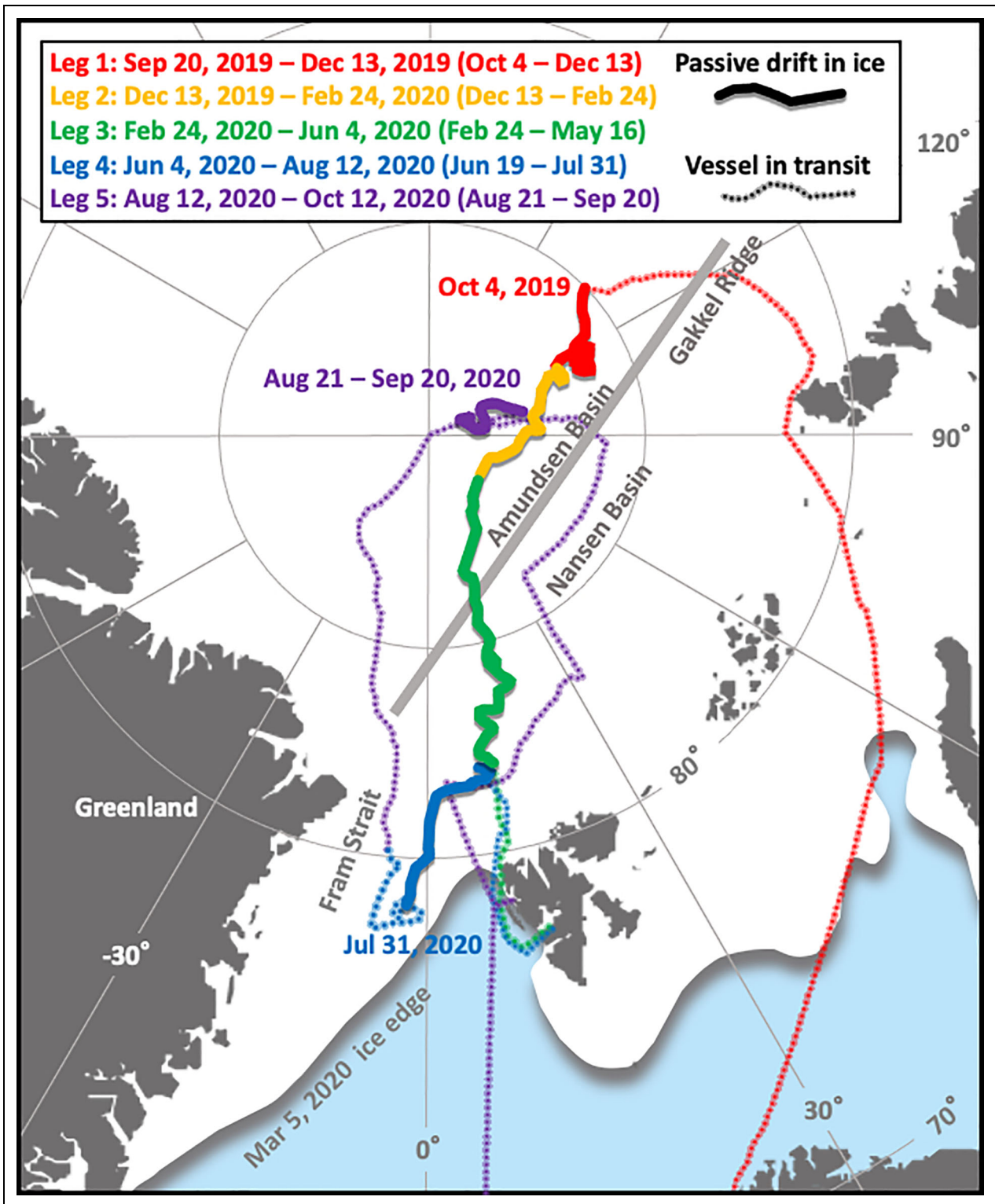

Downloaded from <http://online.ucpress.edu/element/article-pdf/12/1/00135/832720/elementa.2023.00135.pdf> by guest on 22 August 2024

**Figure 1. MOSAiC expedition track.** Passive periods of drift are shown in solid-colored lines, with each color-coded line delineating one of the MOSAiC legs. Dates are periods of each leg; dates shown in parentheses identify passive drift periods per leg. Dotted lines depict transit tracks of the ship initially and for repositioning after Legs 3 and 4. The solid gray line approximates the location of the Gakkel Ridge between the Amundsen and Nansen basins. The approximate sea-ice edge at the annual maximum (March 5, 2020) and minimum (September 15, 2020) is also shown. Modified after Shupe et al. (2020).

like sea-ice meiofauna (Ehrlich et al., 2020; Patrohay et al., 2022) or pelagic zooplankton (Kosobokova and Hirche, 2000; Kosobokova et al., 2011; Ershova et al., 2021; Hop et al., 2021), have evolved life cycles and

physiological adaptations that allow them to survive and successfully compete under these extreme conditions in the ice-covered central Arctic Ocean including dormancy for winter survival in some mesozooplankton taxa

(Kvile et al., 2019). The microbial network, involving diverse bacterial and archaeal communities (Boetius et al., 2015), drives the remineralization of organic matter in ice and water (Laurion et al., 1995; Balmonte et al., 2018; Wietz et al., 2021), which is a key process for supplying nutrients for algal growth. However, heterotrophic bacteria and algae can also compete for inorganic nitrogen resources (Fouilland et al., 2007). The ecological role of Arctic marine viruses is poorly understood, although first insights into virus diversity based mainly on Arctic Ocean shelf sampling indicate a diverse and unique Arctic marine virus community, distinctly different from those in other parts of the world's ocean (Gregory et al., 2019).

Sea ice provides a unique habitat for diverse biota ranging from bacteria to marine mammals and birds, also hosting viruses. It sustains its own food web driven by the productivity of sea-ice algae, which has been reported to contribute locally up to 55% of total primary production in ice-covered areas (Gosselin et al., 1997; Wiedmann et al., 2020). This production is channeled through ice-associated herbivores, including copepods, amphipods, and fish (specifically Arctic/polar cod, *Boreogadus saida*). In fact, trophic marker studies have demonstrated that a substantial part of the organic matter from sea-ice algae culminates in apex species like ringed and bearded seals, or Arctic birds (Kohlbach et al., 2016; Kunisch et al., 2021; Carlyle et al., 2022). Diversity in sea-ice systems is high, including viruses, bacteria, archaea, over 1000 species of unicellular algae and protozoa (Poulin et al., 2011), and about 100 associated metazoan taxa living in the ice-brine channel system or the bottom of the ice (Bluhm et al., 2018 and references within). Due to the high retention of organic matter from previous algal blooms in sea ice, sea ice can contain higher numbers of bacteria than in most other aquatic habitats, with a community often being dominated by Gammaproteobacteria, Alphaproteobacteria, and Bacteroidetes (Deming and Collins, 2017; Torstensson et al., 2021). Less is known about archaeal distribution, diversity, and activity in sea ice. While they can be relatively abundant during the winter season (Thiele et al., 2022), they occur in lower relative abundances in the spring and summer season (Bowman et al., 2012; Deming and Collins, 2017). Viral diversity in Arctic sea ice, where viruses can occur in abundances up to three times above seawater concentrations (Maranger et al., 1994), is currently underexplored, but data from the Arctic and Antarctic indicate a numerical dominance by bacterial viruses with lower diversity but more novelty than in seawater (Gowing et al., 2004; Deming and Collins, 2017; Zhong et al., 2023).

Summer melt ponds and low-salinity meltwater accumulated in leads and under the ice are examples of unique habitats that can form, disappear, and be replenished again multiple times over relatively short timescales during parts of a seasonal cycle (Smith et al., 2023). Under-ice primary production can be high in ice-covered regions: a recent high-resolution biophysical modeling study found that 63% of the total primary production (sea-ice plus pelagic) in the central Arctic occurs in waters with  $\geq 50\%$  sea-ice cover, and 41% of the total primary

production in areas with  $\geq 85\%$  cover (Clement Kinney et al., 2020). While considerable information exists for some regions, seasons, and taxa, the majority of biological components in the ice and ocean have not been identified and quantified through a complete annual cycle, particularly in the high Arctic. Filling this knowledge gap by investigating the full range of trophic components from bacteria to metazoans and exploring their unknown connections has been an ambitious and challenging goal of MOSAiC ecosystem research.

The activities of and interactions between different taxonomic, functional, and trophic groups change in space and time. In the Arctic, the strong seasonality and high interannual variability in environmental conditions such as temperature, nutrient availability, and irradiance drive the ecosystem state, phenology, and functions, as well as their impacts on biogeochemistry (Kosobokova and Hirche, 2000; Leu et al., 2015; Ardyna and Arrigo, 2020). Climate change has already substantially altered the Arctic marine system through increased fractions of first-year sea ice, stronger and warmer inflow from the Atlantic and Pacific Oceans, freshening of the surface waters, later sea-ice formation and earlier onset of melt (Polyakov et al., 2020; Ingvaldsen et al., 2021) with associated biological system responses. For instance, under-ice phytoplankton blooms, algal infiltration communities at the snow-ice interface, and shifts in biodiversity due to borealization are increasingly observed (Fernández-Méndez et al., 2018; Ardyna et al., 2020; Ingvaldsen et al., 2021). Different sensitivities to climate change drivers by various ecosystem components may cause mismatches between trophic levels, such as algal blooms occurring earlier than the zooplankton life stages depending on them as food (Søreide et al., 2010). Also, the shift from a dominance of a multi-year ice (MYI) or second-year ice (SYI) to a first-year ice (FYI) regime will likely impact sea-ice biota; however, evidence for change is patchy due to the limited availability of sufficiently long time series data (Campbell et al., 2022). Comparisons between FYI and MYI diversity of sea-ice protists indicate substantially lower (by 39%) diversity in FYI compared to MYI (Hop et al., 2020). The diversity and presence of sea-ice meiofaunal taxa has also decreased, including the nearly complete absence of flatworms and nematodes in recent studies (Ehrlich et al., 2020). MYI might also act as a seed bank for sea-ice algae and fauna for adjacent newly forming and growing FYI (Olsen et al., 2017). Sea-ice biogeochemical cycles could be impacted, as FYI is typically saltier, with higher brine volume fractions creating more habitable space and permeability, resulting in higher fluxes within the ice and increased nutrient supply (Tedesco et al., 2019). Beyond these structural and functional changes in the sea-ice ecosystem itself, an alteration of the relative contribution of sea-ice algae versus phytoplankton to overall annual primary production also has consequences for other ecosystem components, including through the often tight sympagic-pelagic and sympagic-benthic coupling processes (Wang et al., 2015; Rybakova et al., 2019; Wiedmann et al., 2020).



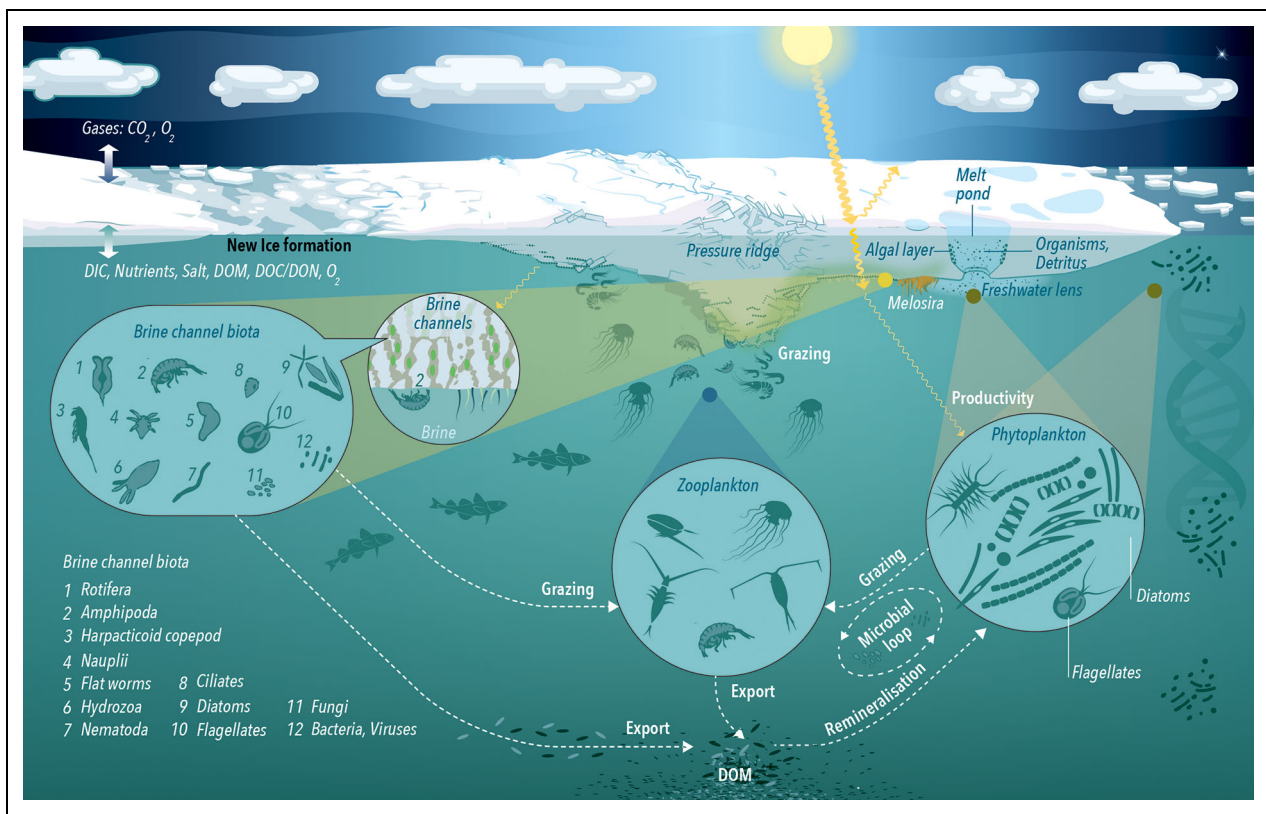

**Figure 2. Ecosystem compartments and processes of the central Arctic.** Illustrated in a simplified manner are the primary components and processes investigated by the ECO team during the MOSAiC (Multidisciplinary drifting Observatory for the Study of Arctic Climate) expedition.

Biological processes in sea ice and seawater are not only relevant for the marine ecosystem but also impact the entire Arctic system. These processes are linked to physical processes in the atmosphere, ice, and ocean through various coupled processes and feedback mechanisms (**Figure 2**). Whereas the strong interdependence between the seasonally changing sea-ice properties and ocean-atmosphere physics is widely recognized (Shupe et al., 2022), the tightly coupled interaction between the sea ice and the biology and chemistry of the ocean underneath is not well understood and, as a consequence, often neglected in numerical models. Biological activity affects the cycling and transformation of inorganic molecules and organic matter and exerts strong controls on the cycling of climate-active gases such as carbon dioxide ( $\text{CO}_2$ ), methane ( $\text{CH}_4$ ), nitrous oxide ( $\text{N}_2\text{O}$ ), and dimethyl sulfide in the ocean and ice, as well as across the atmosphere-ice-ocean interfaces (Falkowski et al., 1998; Campen et al., 2022). For example,  $\text{CO}_2$  concentrations are controlled by a range of chemical and biological processes including organic production, remineralization, gas exchange, and inorganic calcium carbonate precipitation within sea ice and dissolution in sea-ice meltwater (Rysgaard et al., 2007; Fransson et al., 2011; Miller et al., 2011; Rysgaard et al., 2012; Nomura et al., 2018; Angelopoulos et al., 2022) leading to seasonally varying air-sea ice  $\text{CO}_2$  exchange (e.g., Fransson et al., 2013; Mo et al., 2022). Seasonal sea-ice melt decreases the partial pressure of  $\text{CO}_2$  ( $p\text{CO}_2$ ) of the stratified Arctic surface waters through dilution, ikaite

dissolution, and supporting phytoplankton blooms near the surface (Fransson et al., 2017). In recent years, enhanced sea-ice melt has exposed these low  $p\text{CO}_2$  surface waters to high atmospheric  $p\text{CO}_2$  levels, thereby promoting  $\text{CO}_2$  uptake from the atmosphere (Qi et al., 2022). Over longer periods of time, the enhanced  $\text{CO}_2$  uptake decreases the pH buffering capacity of surface waters, promoting vulnerability to ocean acidification (Qi et al., 2022). At the same time, the associated decreased buffer capacity for  $\text{CO}_2$  promotes ocean acidification. Storm events in different seasons can impact air-sea  $\text{CO}_2$  exchange by altering the surface layer  $p\text{CO}_2$  through wind-induced mixing with subsurface water and by creating leads where direct air-sea gas exchange can occur (Fransson et al., 2017). For sea ice itself, rising temperatures and younger sea ice promote an increase in the brine volume fraction, which in turn enhances the transfer of gases and substances across gas-water interfaces within sea ice and between the sea ice and atmosphere (Nomura et al., 2018).

Marine biological processes can impact climate-relevant processes through linkages beyond production cycles of climate-relevant gases. Biogenic compounds that become aerosol particles become airborne through the air-water interfaces of the Arctic and can serve as cloud condensation nuclei and ice-nucleating particles (INPs) in the atmosphere, affecting clouds and the radiative balance of the system (Creamean et al., 2022). This effect, in turn, may feedback on productivity through modulation of the

light available to fuel primary production (Kauko et al., 2017). High-standing stocks of organisms in the sea ice and water column also change the energy budget and heat uptake of these components as they increase the absorption of shortwave radiation, thereby affecting the freeze and melt cycles of their own habitat (Zeebe et al., 1996; Taskjelle et al., 2017). Also, sea-ice microstructural properties relevant for gas exchange can be modified through ice algal production of extracellular polymeric substances (Krembs et al., 2011).

### 1.3. The mission of the MOSAiC ecosystem-focused research program

The MOSAiC sampling program used existing knowledge of ecosystem-relevant processes and components to fill major gaps in current knowledge and explore so far unknown links. The integrated MOSAiC ecosystem research program combined year-round consistent measurements of specific core properties (Tables 1 and 2) with embedded individual research projects (Table S1) and opportunistic sampling. The core program included an extensive suite of biological and chemical components sampled from the water column and from undeformed level FYI and SYI. The aim of the core measurement program was to provide a consistent and continuous backbone of key measurements over the drift period that would allow to link different integrative and complementary process studies (Table S2). The project-specific measurements either provided higher temporal or spatial resolution beyond the weekly sampling program or focused on processes or habitats that were not part of the core parameter time series. Our investigations relied on

a combination of traditional tools and more recently developed technologies and cross-cutting approaches. This combined approach builds on previous studies of the ecosystem in the central Arctic Ocean and within a pan-Arctic context. It aimed at providing new knowledge on the seasonality of high Arctic biologically and biogeochemical processes at unprecedented temporal resolution while simultaneously covering different biological relevant key factors in an interdisciplinary context. The work of the ECO team is focused on three fundamental and essential research questions where we aimed to extend current knowledge and fill associated gaps: (1) Which species are present in the Arctic Ocean (WHO, i.e., *Biodiversity*)? (2) How do fluxes of energy and matter flow through food webs and habitats (HOW, i.e., *Ecosystem functioning*)? and (3) Why do physical and chemical parameters exert control on species distribution and activities and vice versa (WHY, i.e., *Linkages with the environment*)?

*Biodiversity*: The program was designed to capture a full seasonal sampling of sea-ice and seawater habitats, including the dark season, with a wide range of established and innovative tools to achieve (together with current knowledge) the most complete species inventory for ice and pelagic biota of the central Arctic.

*Ecosystem functioning*: The flow of matter and energy in sea ice and seawater substantially changes with time, driven by the strong seasonality of environmental variables (e.g., light and ice freeze-melt cycles) and organism life cycles. Therefore, to determine organism abundances, biomass, and activity rates systematically throughout the MOSAiC drift was essential. The program aimed to quantify the seasonal fluctuations in algal and bacterial

**Table 1. MOSAiC ecosystem core measurements: Bulk parameters (with more details in Table S2)**

ECO Team Variable <sup>a</sup>	Sampled Environments	Method
Nutrients (nitrate + nitrite, ammonium, phosphate, silicic acid, dissolved organic nitrogen, dissolved organic phosphorus)	Water column, sea ice, special habitats	Colorimetric continuous flow; AA3 (SEAL)
Dissolved oxygen (DO)	Water column	Winkler titration
Carbonate chemistry: total alkalinity (TA) and dissolved inorganic carbon (DIC)	Water column, special habitats, sea ice	Coulometry/VINDTA
Dissolved organic carbon (DOC) and nitrogen (DON), concentrations	Water column, sea ice, special habitats	TOC-VCPN, high temperature catalytic combustion
Dissolved organic matter characterization and chemometrics	Water column, special habitats	Ultrahigh resolution mass spectrometry
Particulate organic carbon and nitrogen (POC/N); stable isotopic composition and concentrations	Water column, sea ice, special habitats, short- and long-term sediment traps	%C, %N, $\delta^{13}\text{C}$ , $\delta^{15}\text{N}$ ; EA-IRMS (Flash 2000-Delta V Plus, Thermo Scientific), Euro EA 3000, HEKAtech
Biogenic silica (bSi)	Water column, sea ice	Photometrically after NaOH digestion
Oceanic particle size spectra and distributions	Water column	Optical; Underwater Vision Profiler (UVP)
Chlorophyll <i>a</i> (Chl- <i>a</i> )	Water column, sea ice, special habitats	Fluorometric analyses of extracted samples
Pigment biomarkers	Water column, sea ice, special habitats	High-performance liquid chromatography (HPLC)

<sup>a</sup>Additional geochemical properties (i.e., gases) were measured by the MOSAiC Biogeochemistry Team.

**Table 2. MOSAiC ecosystem core measurements: Biodiversity-related, species-specific, and rate measurements (with more details in Table S2)**

ECO Team Variable <sup>a</sup>	Sampled Environments	Method
Enumeration and diversity of prokaryotes, eukaryotic microbes and viruses	Water column, sea ice, special habitats	Attune NxT (ThermoFisher) and Facs Calibur (Becton Dickson) flow cytometers (FCM)
Diversity and abundance of protists	Water column, sea ice, special habitats, sediment traps	Inverse light microscopy
Diversity of prokaryotes and eukaryotic microbes	Water column, sea ice, special habitats, underway	16S/18S rRNA amplicon sequencing (Illumina)
Metagenomes	Water column, sea ice, special habitats	Illumina
Metatranscriptomes	Water column, sea ice, special habitats	Illumina
Net primary production (NPP)	Water column, sea ice, special habitats, underway	<sup>14</sup> C-based incubations
Net community production	Surface water	MIMS O <sub>2</sub> /Ar
Bacterial production (BP)	Water column, sea ice, special habitats, underway	<sup>3</sup> H-leucine incubations
PSII fluorescence-based photophysiology	Water column, special habitats	FRRF; FastOcean with FastAct/Fastact2 (Chelsea Tech)
Meso- and macrozooplankton: abundance/distribution	Water column	Microscopy, Zooscan
Zooplankton: biomarkers	Water column	Diverse
Zooplankton: carbon and nitrogen	Water column	Elemental analyser
Mesozooplankton: individual respiration	Water column	O <sub>2</sub> optodes
Under-ice fauna: abundance/distribution	Sea ice	Microscopy
Grazing rates (microzooplankton and copepods)	Water column	Experiments
Egg production (copepods)	Water column	Experiments
Gut contents and DNA (fish, copepods, amphipods)	Water column	Microscopy, scales, DNA
Energy content (macrofauna)	Water column	Oxygen calorimeter

<sup>a</sup>Measured from bulk samples as well as individual organisms.

productivity, organismal physiologies (including metatranscriptomes) and life cycles, as well as grazing by micro- and mesozooplankton, diets of key species, and vertical particle fluxes.

*Linkages with the environment:* The combined analysis of ecosystem characteristics with all available MOSAiC environmental data allows us to assess the importance of bottom-up (e.g., light, nutrients, sea-ice characteristics) versus top-down (e.g., grazing, predation) controls on biological standing stocks and activities over a complete seasonal cycle. Likewise, organismal activities contribute to important biogeochemical cycles such as those of macronutrients and inorganic carbon. The program aimed to assess the contributions of ecosystem processes to the Arctic climate system, for example, by driving gas fluxes across ice-ocean-atmosphere interfaces, or by affecting the heat budget of sea ice directly or through interactions with clouds.

These three major focal science areas were approached by considering both their interconnection as well as their relation to the overall MOSAiC science objectives. Therefore, a consistent, coordinated, and methodological framework linking individual measurements within the ECO team was developed. This framework included strong interdisciplinary partnership with the other MOSAiC teams, for example, to co-locate measurements of sea-ice and water column properties and identify biologically relevant linkages between the two habitats. The unique year-round access to the high Arctic environment was used to investigate poorly understood and undersampled habitats and seasons. For example, high heterotrophic biological activities and unique biodiversity patterns in winter were expected to precondition the biological response to the return of light in the spring. We further expected that metagenomic and metatranscriptomic data could be used to identify unique physiological mechanisms that sustain



survival of organisms and ecosystem services under polar seasonality. The program aimed to provide information relevant for understanding a wider Arctic system by determining the fluxes of climate-relevant compounds like CO<sub>2</sub>. Once completed, the achieved gain in knowledge will be placed in both an historic context and a pan-Arctic perspective based on knowledge produced and published in other research efforts (see Introduction).

## 2. Approach and methods

The MOSAiC expedition (PS122) onboard the German research icebreaker RV *Polarstern* (Alfred-Wegener-Institut Helmholtz-Zentrum für Polar- und Meeresforschung, 2017) was organized into 5 cruise legs (Figure 1). The field campaign began in late September 2019. North of the Laptev Sea (Krumpen et al., 2020; Nicolaus et al., 2022b) the first Central Observatory ice camp was established, which was used on cruise Legs 1–3 until May 11, 2020 (Figure 3). ECO team observations began on October 15, 2019, and the full regular weekly

sampling by the ECO team started October 31, 2019, which involved measurements and sampling from the ship and the ice floe. Leg 1 ended in mid-December, and Leg 2 continued until the end of February 2020. Leg 3 extended beyond its originally planned date due to logistical constraints caused by the global COVID-19 pandemic, ending in mid-May 2020, when RV *Polarstern* had to leave the first Central Observatory. Following a logistically necessary break, Leg 4 re-established and occupied a new Central Observatory (Figure 4) at a different location on the same ice floe from June 20, 2020, until the floe disintegrated in Fram Strait on July 31, 2020. Continued observations were made during Leg 5, which involved establishing a new ice camp (Figure 5) located on a new ice floe near the North Pole in the second half of August. The MOSAiC ice drift study ended September 20, 2020, with ECO science operations continuing in the marginal ice zone during the transit back to shore. More details on the MOSAiC campaign can be found in Nicolaus et al. (2022b), Rabe et al. (2022; 2024), and Shupe et al.

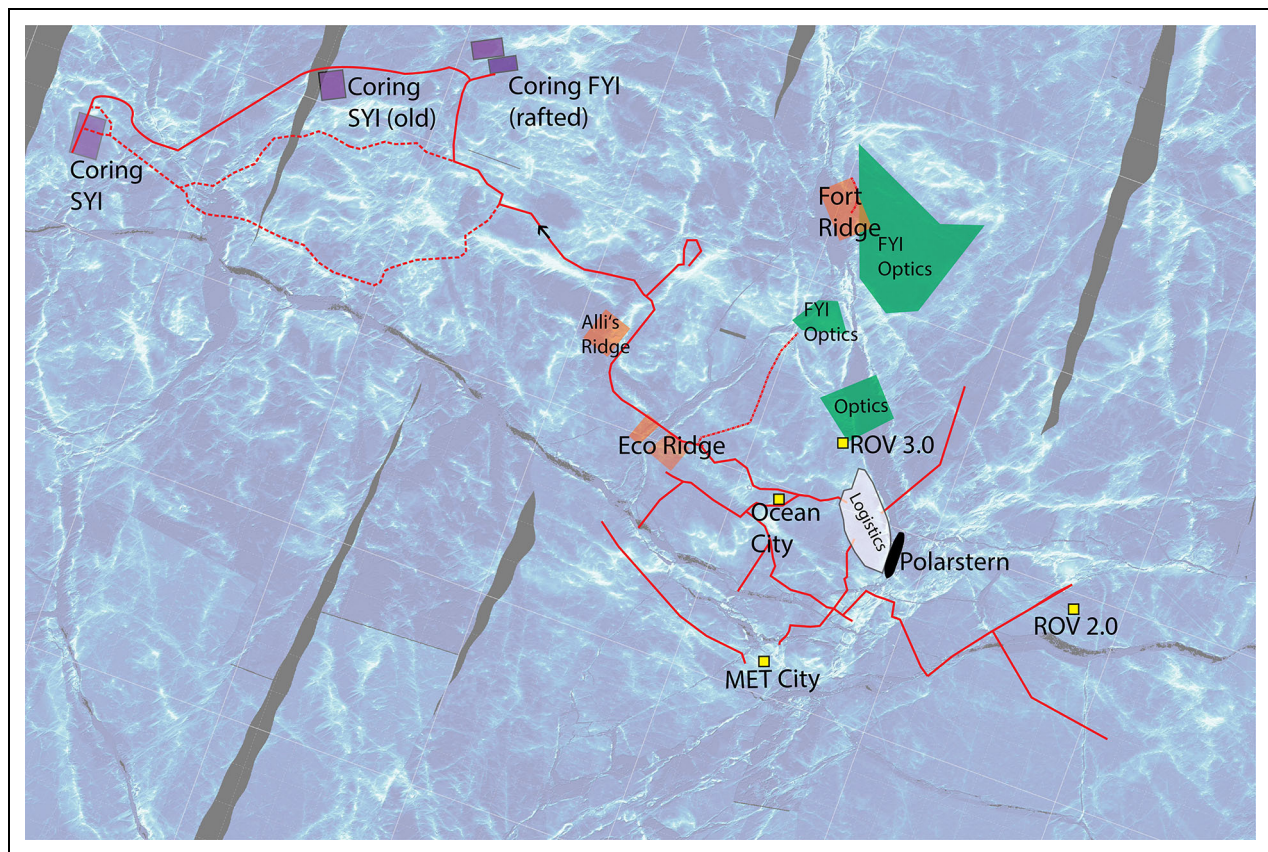

**Figure 3. Main sampling locations and measurement sites of the first MOSAiC Central Observatory (CO1) in April 2020.** Map background shows the airborne laser scanner (ALS) image from April 23, 2020, with gray areas indicating no data. White, brighter areas depict sea ice of greater elevation (i.e., ridge sails). Some site locations were approximate due to active ice dynamics. Sites labeled “old” were previously active sampling locations but were no longer accessible and maintained after the winter. The primary water column sampling locations during October 2019 and May 2020 were conducted at RV *Polarstern* (black) and Ocean City (yellow square). Common ice-coring sites, approximately 1 km from RV *Polarstern*, are shown in purple. The map has been simplified to show main sampling and measurement positions for the ecosystem work program. Additional MOSAiC measurement sites for the ATMO, ICE, and OCEAN teams can be viewed in the respective MOSAiC overviews by Nicolaus et al. (2022b), Rabe et al. (2022; 2024), and Shupe et al. (2022).



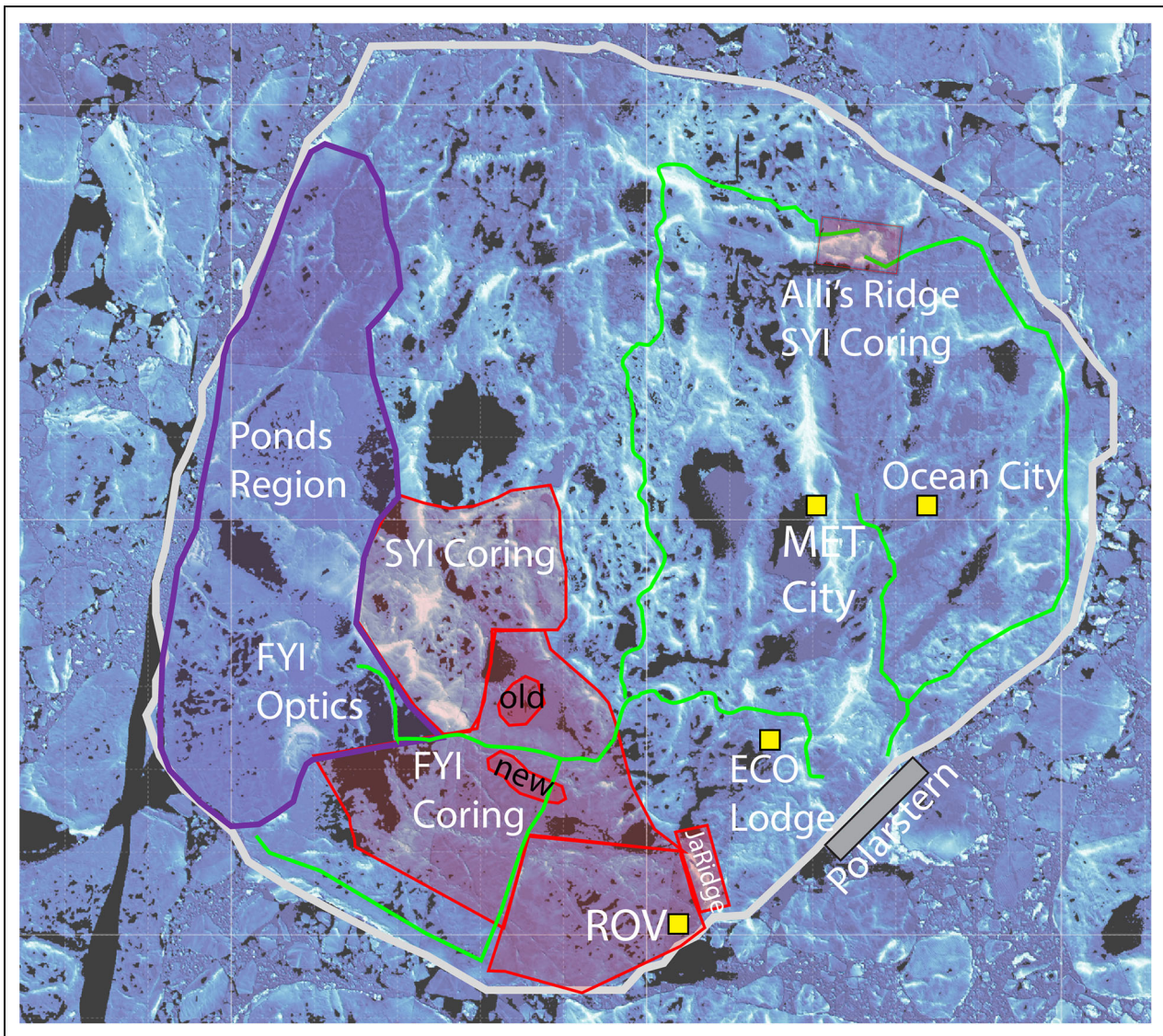

**Figure 4. Main sampling locations and measurement sites of the second MOSAiC Central Observatory (CO<sub>2</sub>) during summer 2020.** Primary water column sampling was from RV *Polarstern* (light blue, lower right side). The Ocean City site did not have a CTD-rosette system. The first-year ice (FYI) coring site was an original portion of the FYI site established in October 2019. The second-year ice (SYI) coring site adjacent to FYI shown here was a reserve SYI site identified earlier but was not actively sampled. Original SYI coring site is not depicted on this map as that part of the ice floe detached from the main floe. SYI coring in June and July 2020 occurred near Alli's ridge. ECO Lodge was established beyond the perimeter of the logistics area. The map has been simplified to show main sampling and measurement positions for the ecosystem work program. Additional MOSAiC measurement sites for the ATMO, ICE, and OCEAN teams can be viewed in the respective MOSAiC overviews by Nicolaus et al. (2022b), Rabe et al. (2022; 2024), and Shupe et al. (2022).

(2022). The water column and sea-ice biogeochemistry of dissolved inorganic compounds is included in the ECO work program, as the biogeochemistry (BGC) team focused on trace gasses and their exchange with the atmosphere (an overview article on the BGC program will be forthcoming; E Damm, personal communication, 15/07/2023). Therefore, biogeochemical parameters such as macronutrients (nitrate, phosphate and silicic acid), the different components of the carbonate system (dissolved inorganic carbon and total alkalinity), as well as the characterization of dissolved organic matter (DOM) in seawater and sea ice are part of the evolving ECO datasets.

### 2.1. Water column work program

Sampling and measurements in the water column occurred at frequencies from daily, to weekly, with opportunistic, intensive observational sampling occurring a few times during the expedition on an hourly timescale for periods of 20–30 hours. Sampling frequency was based partially on feasibility and cost-benefit evaluation. For most ECO properties, the primary sampling mode was weekly sampling, matching the anticipated rates of change in ecological properties relative to anticipated achievability of the sampling program by a small onboard team. The daily sampling for chlorophyll *a* (Chl-*a*) and



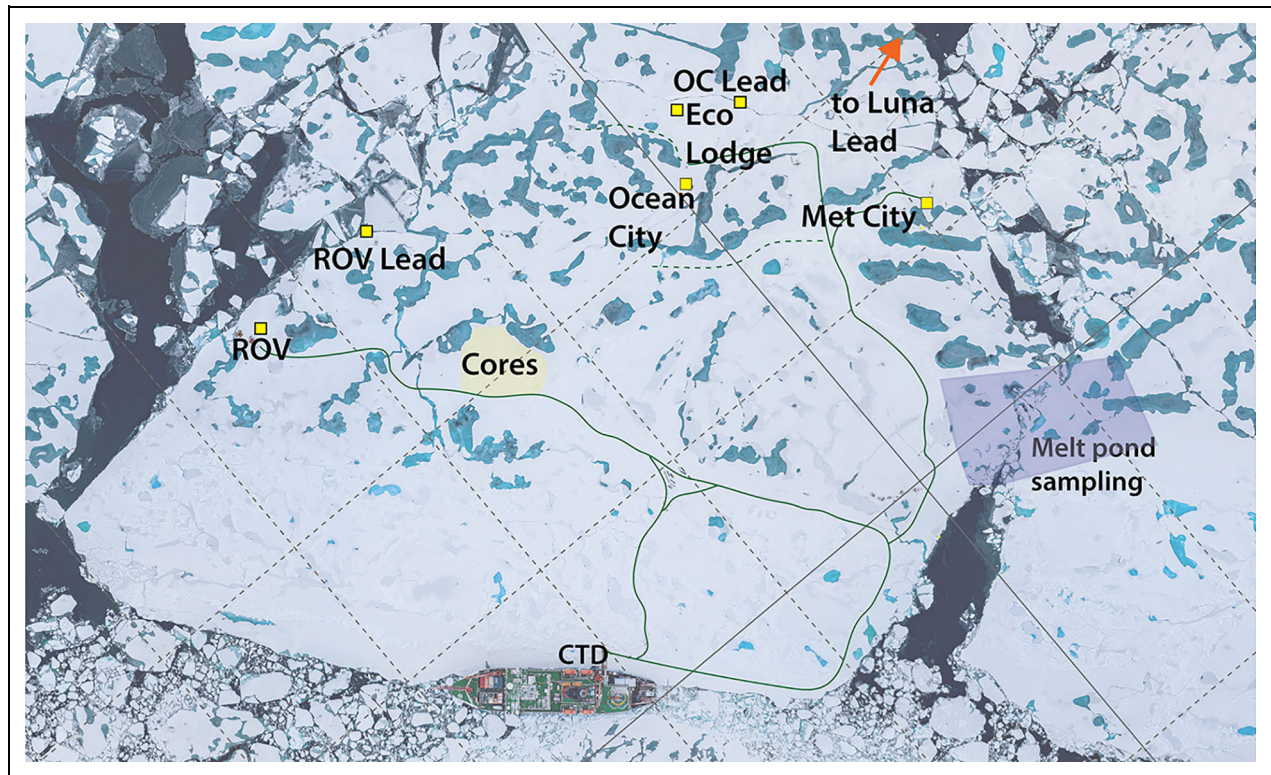

**Figure 5. Main sampling locations and measurement sites of the third MOSAiC Central Observatory (CO3) during late summer 2020.** The background of the map is an aerial photo of the ice floe (photo credit S. Graupner). Primary water column sampling was from RV *Polarstern* (bottom middle). The Ocean City site did not have a CTD-rossette system. Ice cores (not new ice formations) in August and September 2020 were sampled from a single site (yellow area). New ice formation and waters from the upper ocean (1–2 m) were sampled at OC, ROV, and Luna leads. The ECO Lodge site was established adjacent to Ocean City lead, approximately 300 m from the ship. The map has been simplified to show main sampling and measurement positions for the ecosystem work program. Additional MOSAiC measurement sites for the ATMO, ICE, and OCEAN teams can be viewed in the respective MOSAiC overviews by Nicolaus et al. (2022b), Rabe et al. (2022; 2024), and Shupe et al. (2022).

microbial community structure resolved day-to-day changes in these fundamental microbial properties, which would have been missed with only once-weekly sampling. Herein, major operations executed by the ECO team are organized by sampling frequency and described briefly, while detailed method descriptions will be provided in later, targeted publications.

### 2.1.1. Continuous measurements and daily sampling approaches

A membrane-inlet mass spectrometer (MIMS) connected to the ship's flow-through seawater system allowed the continuous measurement of dissolved  $O_2$  and Ar concentrations to calculate  $O_2/Ar$  ratios and infer net community production (Tortell, 2005; Ulfsbo et al., 2014; S Rokitta, unpublished results). The depth of the seawater intake port was 11 m below sea level at the keel of the ship. Continuous measurements of these properties were interrupted only during (1) routine maintenance procedures by instrument operators, (2) ship maintenance of flow-through systems, and (3) measurements of discrete bottle samples. Therefore, gaps in the continuous data, which were collected mostly from March to October 2020, are approximately (1) once daily for 1–2 hours, (2) 1–2 times monthly for 3–6 hours, and (3) 3–4 hours weekly. Onboard, routine calibration with

reference gasses allowed for tracking of instrument drift over the course of the expedition.

The AUTOMated Filtration for marine Microbes (AUTO-FIM) instrument (iSiTEC GmbH, Bremerhaven, Germany) automatically collected, filtered, and preserved water samples for molecular genetic analyses (Metfies et al., 2016) from December 2019 to October 2020. This instrument is permanently installed on RV *Polarstern* a few meters from the flow-through seawater intake system 11 m below the bow of the ship. AUTO-FIM collected samples on a daily basis and, in some instances, at even higher temporal resolution to resolve spatial changes along the drift path. Samples were analyzed for microbial community structure using 16S and 18S rRNA amplicon sequence-based approaches.

The fishcam, an in situ video system (FishCam, MacArtney Germany GmbH, Kiel, Germany), was deployed on average at 375 m water depth (range 369–376 m) from October 23 to November 7, 2019, and at 213 m depth (range 194–215 m) from December 12, 2019, to March 11, 2020, through a hole in the ice approximately 500 m away from the ship (see Snoeijs-Leijonmalm et al., 2022 for details). The system included two HD Internet Protocol cameras, one looking sideward and one looking downward, two Luxus High-Power LED light sources of 6000 lm

each, and a mini-CTD. The system was connected to a personal computer onboard, running PortVis (Serial Port and Video Stream Visualizer) software, version 2.1. Camera images were recorded in LED on:off cycles of 5:55, 15:15, or 55:5 min.

Hydroacoustic backscatter profiles of zooplankton and fish were continuously recorded with the EK60/EK80 echosounder of RV *Polarstern* during the entire MOSAiC expedition. The echosounder was equipped with transducers emitting and receiving sound at nominal frequencies of 18, 38, 70, 125, and 200 kHz mounted on the underside of the ship's hull at about 11 m water depth. Hydroacoustic backscatter data of zooplankton and fish were collected between about 20 m and 600 m water depth, depending on the frequency and the environmental conditions (Snoeijs-Leijonmalm et al., 2022).

A number of discrete water samples were collected manually at a daily or near-daily frequency over the duration of the expedition from a single tap of the ship's flow-through seawater system, which was also used for the MIMS measurements. This collecting included separate samples for (1) Chl-*a* (except from mid-December to end of February), (2) 16S and 18S rRNA amplicon-based microbial community analyses (except from mid-December to end of February), and (3) INPs (full-time series).

To investigate downward flux, a long-term ice-tethered time series sediment trap (McLane PARFLUX Mark 78H-21) with 21 sampling cups was deployed at 200 m water depth, and tethered to SY1, located approximately 1000 m away from the ship (**Figure 3**). Sinking particles were collected automatically for 2-week intervals (15 or 16 days) from March to November and every month (29–31 days) from December to February. The sampling cups were filled with salt-saturated artificial seawater and HgCl<sub>2</sub> prior to deployment. The sediment trap was operational from October 26, 2019, to July 31, 2020.

### 2.1.2. Discrete sampling

The primary sampling approach for the weekly ECO time series of water column biological and chemical properties relied on the ship's conductivity, temperature and depth (CTD) rosette, a suite of plankton nets, and a number of small animal- and particle-imaging instruments with deployments over 3 consecutive days per calendar week. The CTD sensor packages, calibration methods, and post-processing are described in Rabe et al. (2022) and Tippenhauer et al. (2023a; 2023b). In brief, discrete biological samples were collected from 12-liter OTD bottles attached to the shipboard 24-bottle CTD rosette (PS-CTD). From November 2019 to May 2020, additional water column sampling was conducted via a 5-liter 12-Niskin bottle CTD rosette from the site called Ocean City (OC-CTD; via a sheltered in-ice hole located 300 m from RV *Polarstern*; see **Figure 3**). In the period between mid-March and mid-May, the PS-CTD was not operational due to the loss of the ice hole alongside the ship (see Rabe et al., 2022), so all ECO water column samples were collected at Ocean City. During this period, use of the OC-CTD led to a lower vertical depth resolution as the total water volume collectable in one cast was substantially less with the OC-CTD (60 L)

than with the PS-CTD (288 L). All sampling events are listed in Table S3. Sampling order from the individual rosette bottles primarily followed WOCE procedures (Woods, 1985), which prioritize the sampling of tracers, gases, and nutrients in time before the sampling of other properties. This sequence prioritized sampling of time-sensitive properties and limited contamination between parameters. Co-location of many properties across a smaller number of depth horizons was prioritized over higher vertical resolution of a few properties (**Figure 6**). Additionally, upper 200 m water column sampling was prioritized over full water column profiling to better resolve upper ocean interactions with sea ice and the atmosphere. Sample types requiring large volumes (e.g., particulate organic carbon and nitrogen, POC/N; DNA and RNA) made it necessary to collect samples in additional casts following a primary full water column cast used to collect small volume ECO samples. Standard water depth horizons for biological properties were 2 m, 10 m, and Chl-*a* fluorescence maximum (if present based on the CTD fluorescence sensor profile) or 20 m, 50 m, 100 m, and the Atlantic Water core depth. The depth of the Atlantic Water core, detected as the local temperature maximum in each profile, varied significantly along the drift path, from approximately 100 m close to Fram Strait up to 400 m in the Amundsen Basin (Rabe et al., 2022; Schulz et al., 2024). The depth-resolved sampling for Chl-*a*, nutrients, and total DNA collected from the PS-CTD and OC-CTD rosettes over the drift duration relative to a reference depth (400 m) and bottom depth highlight the focus of sample collections in the upper water column (**Figure 7**).

Samples collected by the ECO team during the routine CTD rosette-based water column sampling included a wide range of standard variables such as inorganic nutrients (nitrate + nitrite, nitrite, silicic acid, phosphate, and ammonium) as well as total dissolved nitrogen and total dissolved phosphorus, total dissolved inorganic carbon (DIC) and total alkalinity (TA), dissolved organic carbon (DOC), colored dissolved organic matter (CDOM), Chl-*a*, algal pigments, POC/N concentrations as well as their isotopic compositions, biogenic silica (bSi), total DNA and RNA for sequencing, and taxonomic cell counts (via light microscopy) as well as cell abundance (via flow cytometry). Samples for primary and bacterial production, dissolved oxygen, DOM characterization after solid-phase extraction, and <sup>14</sup>C-DIC were collected at a lower temporal frequency and with larger gaps due to instrumentation failures. Additionally, several complementary samples were collected on a routine basis, such as those for measurements of O<sub>2</sub>/Ar ratios in discrete samples, INPs, neutral sugars, and <sup>15</sup>N-nitrate isotopes. Processing of preserved water or filters mainly occurred at the shore-based laboratories, with exceptions of onboard measurements of nutrients (November 2019 to May 2020), dissolved oxygen (March to October 2020), primary and bacterial production (December 2019 to May 2020), and a subset of Chl-*a* samples (March to May 2020). Details on sample processing methods can be found in Table S2.

We aimed for all analyses for each variable to be done in the same laboratory and/or using the same instrument

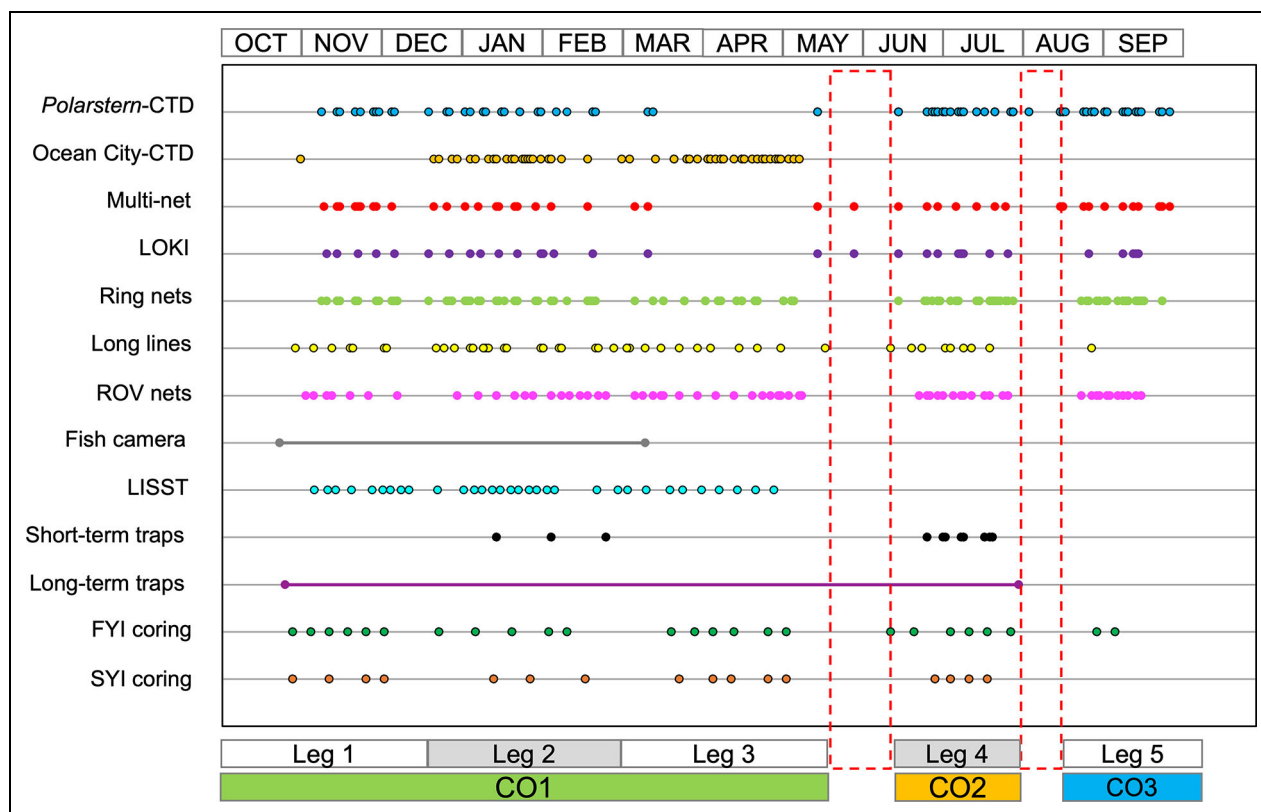

**Figure 6. Frequencies of ecosystem observations and measurements during the field phase of MOSAiC.** Each row shows the dates of a sampling event for a specific type of gear (e.g., *Polarstern*-CTD) or sampling activity (e.g., FYI coring). Solid lines indicate instrumentation deployed through the ice for a continuous period. A number of parameters were collected from an individual sampling event, such as deployment of the *Polarstern*-CTD rosette system. Alternating white and gray horizontal bars at the bottom of the chart indicate the MOSAiC leg. Colored horizontal bars indicate from which Central Observatory (CO) samples were collected. Dashed red line boxes identify the periods when RV *Polarstern* was transiting to/from an ice floe. LOKI indicates Light-frame On-sight Key species Investigation system (zooplankton camera system); ROV nets, plankton nets towed by a remotely operated vehicle; LISST, Laser In Situ Scattering and Transmissometer (particle counter); FYI, first year ice; SYI, second year ice.

to decrease uncertainty due to laboratory or instrument calibration (see Table S2 for details). In cases where this approach was not possible (DIC/TA, DNA, RNA, POC/N), samples for interlaboratory calibration were collected. In the case of nucleic acid samples, aliquots from the same extracted samples of the core time series were used for specific sequencing approaches in specialized labs (e.g., metabarcoding, genomics, sequencing of specific meta-zoan, or functional primers). Details on the ECO multi-omics sampling program are given in Mock et al. (2022).

The seasonal life cycles and vertical distribution of zooplankton abundance and biomass were studied using imaging tools and plankton nets, deployed on the same day or on two consecutive days during a calendar week. From November to March and from June to September, a multinet midi (Hydrobios), three ring nets, the Underwater Vision Profiler (UVP), and the Light-frame On-sight Key Species Investigation system (LOKI) were deployed through a large hole in the ice alongside the RV *Polarstern*, yielding an almost weekly resolution for many targeted parameters (Tables S4 and S5). The multinet was equipped with five nets of 150  $\mu\text{m}$  mesh size to sample five discrete depth intervals between 2000 m and the ocean surface.

Those samples were processed for zooplankton identification, abundance, and biomass at shore-based laboratories. The LOKI was deployed approximately weekly from 1000 m to the surface. In addition to high-resolution images, the instrument obtained hydrographical parameters, for example, depth, temperature, salinity, oxygen concentration, and fluorescence. The UVP was mounted on the PS-CTD rosette, and casts were conducted from various depths to the surface. Ring nets of 1 m<sup>2</sup> area (150  $\mu\text{m}$  and 1000  $\mu\text{m}$  mesh) and 0.28 m<sup>2</sup> area (53  $\mu\text{m}$  mesh) were deployed to varying depths up to 2000 m to collect zooplankton for analysis of taxonomy, energy content, biomarkers, and gut DNA (Table S4). However, the hole next to the vessel could not be maintained in April and May due to strong ice dynamics. During that period, only a 150  $\mu\text{m}$  mesh Nansen net and the 53  $\mu\text{m}$  mesh ring net could be deployed at the ice hole at OC. The Nansen net was equipped with an opening/closing device and was deployed in a series of single casts to the same depth intervals as sampled by the multinet down to a maximum depth of 800 m. Additional ring net tows were conducted over the same depth intervals as used for the multinet to collect animals for biochemical and genetic analyses and



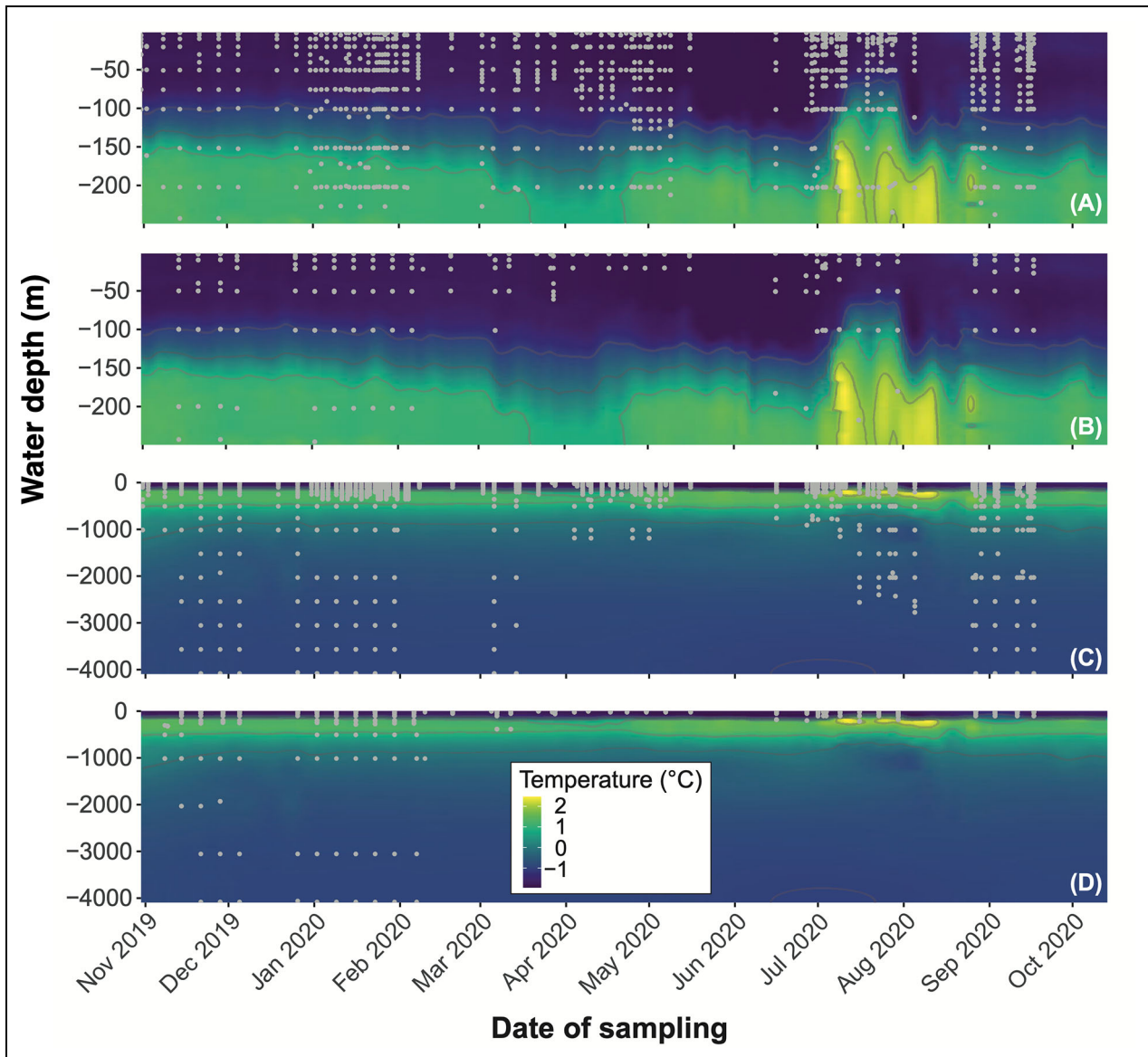

**Figure 7. Temporal and spatial distribution of water column sample collections for nutrients and DNA.**

Sampling locations (gray dots) are displayed for (A, B) the surface (upper 250 m) and (C, D) the entire depth profile (0–4000 m). For oceanographic context, all available temperature data from the core hydrographic dataset (Schulz et al., 2023) are shown as colors and isotherms. This dataset combines CTD-rosette with autonomous sensor measurements and is thus also available when *Polarstern* was not located in the study area. From mid-March to May 2020, the *Polarstern*-CTD was not operational (closure of the ice hole) and water column sampling was limited to the upper 1000 m using the Ocean City CTD system. Additional details for this figure are provided in Table S8.

physiological rate measurements. In addition, during all seasons, a net was attached to the under-ice remotely operated vehicle (ROV) “Beast” (ROVnet; Katlein et al., 2017) for sampling 2–3 depth horizons: the ice-ocean interface, 10 m, and 50 m under the ice.

To determine zooplankton abundance and biodiversity, usually complete samples from multi-, Nansen-, and ROV-net casts, as well as samples taken with the small ring net (Table S5), were preserved with hexamethylenetetramine-buffered 4% formaldehyde, stored at room temperature and subsequently processed in laboratories in Germany (AWI) and the United States (University of Rhode Island). Live specimens for biochemical analyses and physiological rate measurements were sorted from ring net samples

under a stereomicroscope onboard and determined to the lowest possible taxonomic level. Only when abundances were low, large organisms were also sorted from multi- and ROV net samples allocated for taxonomic analyses to obtain sufficient individuals. Most of the live specimens (>10,000 individuals during the entire expedition) were deep-frozen, either individually or pooled in groups depending on size, for biochemical measurements (e.g., total lipid content, C/N ratio, energy content, lipid class composition, omega-3 fatty acids and level of animal sterols such as cholesterol and desmosterol,  $\delta^{13}\text{C}$  and  $\delta^{15}\text{N}$  values), as well as for molecular studies of gut contents (copepods, amphipods) and for biodiversity (gelatinous zooplankton). Key mesozooplankton species

(e.g., *Calanus glacialis*, *C. hyperboreus*, *Metridia longa*, *Themisto* spp.) were photographed prior to freezing to measure certain characteristics digitally, for example, prosome length (copepods) and oil sac volume (*Calanus* spp.). For experimental work, individuals of key species were incubated for at least 24 h to determine egg production, grazing and respiration rates, and thereafter, deep-frozen to measure organic carbon and nitrogen contents to calculate biomass specific rates. Also, fish were caught via long lines and fishing rods deployed through the moon pool or holes in the ice (Snoeijs-Leijonmalm et al., 2022).

## 2.2. Sea-ice coring and processing

The coordinated sea-ice sampling by the MOSAiC teams ICE, ECO, and BGC was designed to study the seasonal changes of physical, biological, and geochemical properties of FYI and SYI in an interdisciplinary context (see also Angelopoulos et al., 2022; Nicolaus et al., 2022b; Salganik et al., 2023). During fall 2020, ice areas of undeformed FYI and SYI were identified that were safely accessible by snow machine, relatively homogeneous, and large enough to accommodate repeat visits, potentially for the entire drift. Most importantly, sites had to be located away from RV *Polarstern* to avoid and minimize the impacts of (1) artificial light pollution, (2) regular on-ice foot traffic, (3) fumes and particulate material from the ship's exhaust system and snow machines, and (4) "technically clean water" discharges from the ship.

Tents were set up at each ice coring site to protect newly extracted ice cores from adverse environmental conditions during sectioning, which could quickly alter ice and its physical, biological, and chemical properties. Cores for biological properties were collected using a 9-cm diameter KOVACS Mark II coring system. All coring events are summarized in Table S6. Most cores were sectioned and placed into sterile Whirlpak bags directly inside the tent under low and/or red-light conditions to minimize artifacts. In some instances, complete cores were bagged directly in the field and processed on the ship, but in-field sectioning was prioritized when conditions were amenable. Ice core properties were derived from individual core sections or pooled core sections (**Figure 8**) depending on individual property requirements. Pooled core sections provided larger melt volumes and sub-sampling for multiple properties from single horizons. Small-scale horizontal variability was reduced by pooling core sections, creating a more homogeneous master sample from which to derive related properties.

Six to eight full-length ice cores designated for ecological and biological properties were sectioned using similar sectioning schemes and placed into new, sterile Whirlpak bags in the field. Cores were sectioned from the bottom into two 5 cm sections, and then subsequently at 10 cm intervals from top and bottom, leaving a variable length middle section. Middle sections varied by several cms across 3–4 cores. Two pools (termed ECO1 and ECO2) using this procedure were generated and sub-sampled for

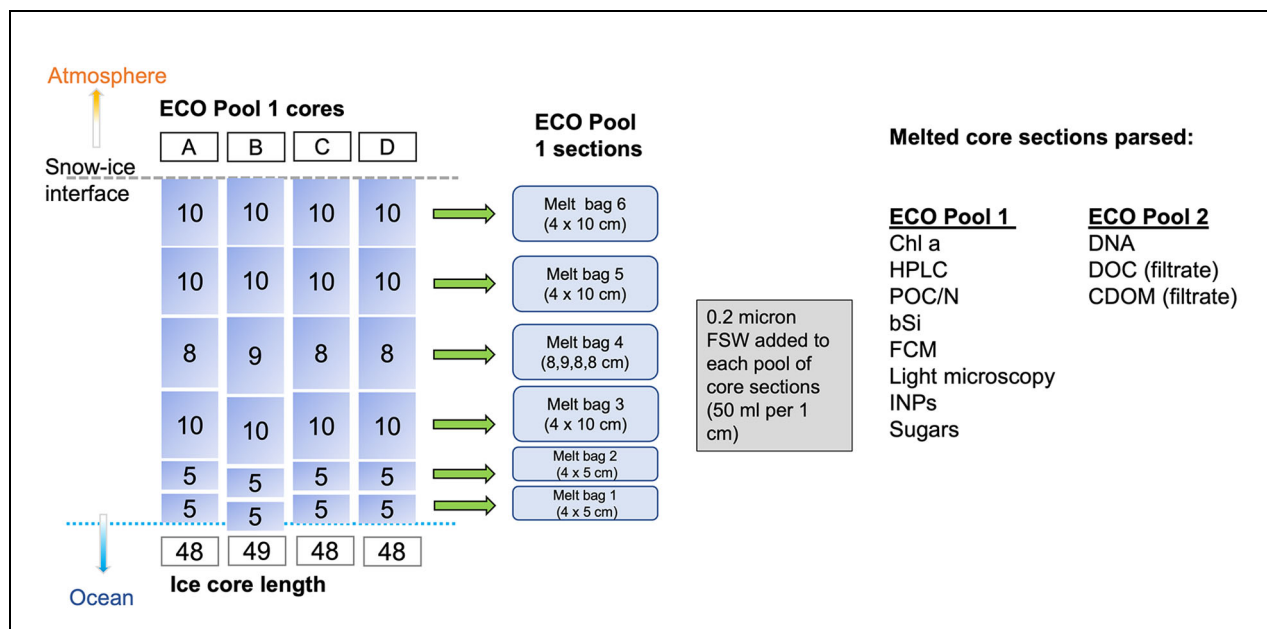

**Figure 8. Ecological sea-ice core pooling and processing.** Full-length cores were sectioned in the field and placed in pre-labeled melt bags. Filtered seawater (FSW) was added onboard to each melt bag. After complete melt, pooled samples were distributed (parsed) for analysis of different properties. When possible, 2 ECO pools were generated. Additional samples were collected from cores taken for salinity/oxygen and dissolved inorganic carbon/total alkalinity measurements, as well as from additional bottom sections. FSW indicates filtered seawater; Chl-*a*, Chlorophyll *a*; HPLC, high-performance liquid chromatography; PO/N, particulate organic carbon and nitrogen; bSi, biogenic silica; FCM, flow cytometry; INPs, ice nucleating particles; DOC, dissolved organic carbon; CDOM, colored dissolved organic matter.

a majority of biological properties from these two sets (**Figure 8**). In addition, the bottom 0–3 cm or 0–5 cm of sea ice from 3–4 cores were collected, sectioned, and pooled for individual sets of measurements of net primary production (NPP pool) and occasionally bacterial production (from NPP pool), as well as a pool for metatranscriptomes (RNA pool) in the field. Occasionally, full profiles of bacterial production were measured from ECO1 pools.

A single core was collected for bulk salinity, oxygen isotopic composition, and inorganic nutrients. This core was sectioned in the field at 5 cm intervals from the top and bottom, leaving a variable-length middle section (Nicolaus et al., 2022b; Salganik et al., 2023). Individual cores were collected for DIC/TA and gypsum. These cores were bagged completely in the field and either sectioned and processed onboard or stored frozen for future processing onshore.

Ice cores and sections were transported back to the ship in coolers, protecting cores from fluctuations in light and temperature. All ECO pool samples were melted after the addition of 0.2  $\mu\text{m}$  filtered surface seawater (typically 50 mL per 1 cm of core section) to reduce the impact of osmotic stress and cell loss (Garrison and Buck, 1986; Campbell et al., 2019; Chamberlain et al., 2022). Ice core sections in bags were melted in the dark at room temperature (18–22°C) and checked every 4–6 hours. Upon completed melt, which took 12–40 hours, bags were transferred into dark, temperature-controlled laboratory containers, and sub-sampled for biological properties under dim red light to minimize artificial light stimulation of biological activities. Samples for Chl-*a*, algal pigments (analyses by high-performance liquid chromatography), POC/N, bSi, taxonomic counts (light microscopy), and cell abundances (flow cytometry), INPs, and neutral sugars were typically collected from ECO1 pool (**Figure 8**). DNA samples were filtered through 0.2  $\mu\text{m}$  filters from ECO2 pool, and the filtrate was reserved for DOC and CDOM determinations. For each melted core section, melt volume factors were derived from added meltwater volume, which were used to calculate melted ice volumes. Data are reported as per unit volume melted ice core as no correction for differences in density of ice and melt water were available.

Core sections for measurements of inorganic nutrients and nitrate isotopic composition were directly melted in the dark (without seawater addition). Samples were pre-filtered through a 0.45  $\mu\text{m}$  filter membrane and either analyzed directly onboard, or frozen for analysis onshore.

DIC/TA cores were sectioned onboard in a freezer laboratory (–15°C) at 10 cm intervals from top and bottom, with a variable length middle section. Sections were placed inside gas-tight bags and air was removed using a vacuum pump to avoid CO<sub>2</sub> exchange. These core sections were directly melted in the dark at 4°C, without the addition of buffer or conservational solution. Melted samples were transferred into 250 mL borosilicate bottles, augmented with 60  $\mu\text{L}$  of saturated mercuric chloride (HgCl<sub>2</sub>) solution, and sealed with a septum cap to prevent CO<sub>2</sub> exchange with the atmosphere, then stored cool until post-cruise analyses in Japan (Nomura et al., 2020).

### 2.3. Event- and process-driven sampling

In addition to the time series sampling of water column and sea ice, additional samples were collected either on an opportunistic or event- and process-driven basis (see Table S7 for an overview of all sampling events). For many of these sampling events, samples for a smaller subset of parameters were collected, with Chl-*a* and nutrients being the most regularly sampled properties.

Water samples for biological properties were collected from leads from the upper 1.5 m of water directly below newly forming ice or within the sea surface using peristaltic or hand pumps, from October through early March, and again from early July until the end of the drift in September 2020. Newly forming ice was collected by sieves, saws, buckets, and/or ice corers throughout the drift period, except during the continuous melt period between June and end of July 2020. Ecological properties of the seasonally occurring melt ponds were sampled only during August and September 2020. Similarly to leads, both ice and water from within and under melt ponds were sampled. Ice from leads and melt ponds was processed without filtered seawater addition on most sampling instances, while filtered seawater was added to ice collected between March and May 2020, similar to the handling of time series samples of sea ice. Sampling of various stages of ice formation and consolidation was conducted in the marginal ice zone (MIZ) during the transit back to shore at the end of the field campaign (September 2020). Here, a small number of biological properties from sea ice, direct under-ice waters, and the water column was collected from 3 stations. Unconsolidated ice types collected from these transit stations were primarily from ice floe edges. The distribution of biological properties in pressure ridges (deformed sea ice) was studied using ice coring of keel blocks and collecting water from ridge keel voids (seawater-filled voids between ice blocks in the ridge keel) and below ridges.

Water directly from the ice-water interface below level ice was collected except for August to October 2020 for project-specific experimental work by deploying a hand pump through a borehole in the ice. Similarly, under-ice water from the upper 2 m of the water column was occasionally sampled via hand pumps in connection to the common time series coring activities.

In addition to these more opportunistic sampling events, intensive observational periods (IOPs) were included to address research questions on timescales shorter than the 1-week interval of the time series. For example, higher frequency temporal sampling (i.e., 4–10 time points in periods of 20–30 hours) was conducted to observe potential diurnal dynamics as well as biological changes as a result of important events such as high wind periods, or the onset of freeze. In the beginning of December, a 24-hour IOP was conducted with zooplankton collections via both ROV nets and LOKI. In July, two 24-hour IOPs were conducted. The first one in the beginning of July consisted of three LOKI casts and six CTD rosette casts from the ship to cover diurnal patterns in the water column. A second IOP was conducted 1 week later during rapid melt to investigate diurnal patterns in the direct

under-ice habitat. In September 2020, two IOPs were conducted. In the beginning of September, a 36-hour IOP was conducted in collaboration with the OCEAN team to investigate the effects of a high wind event. Collections of under-ice waters occurred within a temporary on-ice laboratory, termed “EcoLodge,” established during the summer period. From June to mid-August 2020, EcoLodge1 was situated approximately 110 m from the ship on level ice, that is, closer than other major sites but with an under-ice environment that was comparable in terms of ice thickness to the FYI coring site, and with surface waters less affected by disturbance from the ship compared to the PS-CTD rosette system. Here, under-ice water with brackish salinity (10–15) was sampled using a peristaltic pump, and filtered directly for Chl-*a*, POC/N, and microbial community structure analyses. Samples for inorganic nutrients and cell abundance were also collected. During August and September, the re-established EcoLodge2 was located approximately 300 m from the ship on level ice and approximately 15 m from a small, dynamic lead. Here, ice thickness was 125–130 cm. EcoLodge2 served as a hub for under-ice water sampling via a peristaltic pump at 14 timepoints over 36 hours. One week later a similar IOP at EcoLodge2 with 12 time points over 24 hours was conducted to assess the impacts of the onset of freeze up.

#### **2.4. Modifications to routine ship-based and on-ice operations for ecosystem sampling**

As a number of regular ship operations were considered potential sources of contamination, we took precautions to limit their potential impact. For example, prior to MOSAiC, the ship would release gray water continuously from an outlet located starboard side at 5 m depth. The location and constant release of gray water posed a potential risk to our sampling efforts as this location was within meters of the main PS-CTD sampling. While gray water is technically clean enough to drink, it could carry residual microbial, DOM, and nutrient contamination. Also, there was a chance that the gray water, being less saline than ambient seawater, would float toward the surface and interact with the underside of the ice floe, potentially altering important characteristics of the ice and its development. Therefore, during MOSAiC, gray water was retained in the ship’s hold for 2–3 days, had salt added back into the solution to increase its salinity, and was pumped to 150 m depth from the ship’s moon pool. Gray water pumping was conducted on days when no active water column sampling was conducted.

A monthly cleaning routine of the engine’s boiler systems was one aspect of normal ship operations, of which we had not been aware in advance, that may have impacted our sampling efforts around the ship. Unlike gray water handling, this operation was not possible to adapt. While the dates of the monthly release and of measurements on and around those dates can be reviewed to identify any abnormalities, no direct measurements on possible contamination were made.

The ship also emitted continuous artificial light during the drift. Due to safety regulations, the use of light near the ship during our water column sampling could not be

reduced significantly. When sampling of the PS-CTD rosette during times of natural darkness (i.e., the polar night), we reduced the light contamination during sampling by a combination of room shading and shaded containers for sample collections (Marangoni et al., 2022). Because the floe drifted in different directions and speeds compared to the water column below, the effects of light pollution on water column-based time series sampling of biogeochemical and many biological parameters can be expected to be minimal. However, some biological properties, for example, physiological rates of sampled organisms and diel vertical migration pattern may have been impacted (Ludvigsen et al., 2018). Comparing migration patterns from different devices and locations (e.g., acoustic zooplankton fish profilers located at different distances from the ship; J Berge, personal communication, 12/04/2021) may help to evaluate potential impacts. For sea ice, impacts of artificial light pollution on photosynthetic biomass and physiology may be much larger, as small effects may accumulate over time. To account for this possibility, the long-term sea-ice time series sites were established >1 km from the ship, where light pollution was not detectable. In the field, shaded tents were used for ice processing to reduce the effect of strong ambient light and temperature increases on ice samples during summertime. In the ship board laboratories, samples were processed under temperature-controlled, red-and/or low-light conditions.

In addition to reducing artificial light pollution, we also aimed to reduce the introduction of nutrients and dissolved carbon to our sea-ice samples through our melt process. For most ecological properties collected from sea ice, buffering the melt process with a known volume of saline solution can reduce the impact of osmotic stress and cell loss (Garrison and Buck, 1986). Therefore, we planned to make and add an artificial saline solution, consisting of distilled water and analytical grade sodium chloride, to our sea-ice core sections. However, the onboard nutrient analyzer showed that the artificial saline solution contained about  $1 \mu\text{mol kg}^{-1}$  nitrate + nitrite, which, at the start of the drift, was more than 10 times the ambient sea surface water nitrate + nitrite concentration. Therefore, despite our preparations, filtered surface seawater additions were used in the ice core melting process, which impacts some of our parameters such as DOC and INPs.

#### **2.5. Integrative approaches across the ECO teamwork program**

In the following sections, some of the approaches that were employed to gain a holistic understanding of seasonal variations in species composition and food web dynamics are highlighted. Further, pathways are identified toward synthesizing different datasets to address overarching questions in how organisms, and physical properties and processes, control the flow of material and energy. The integrated multi-omics approaches are detailed in Mock et al. (2022).

##### **2.5.1. Imaging**

Imaging has become an essential tool in zooplankton studies in the last two decades (Lombard et al., 2019;

Giering et al., 2022). The in situ cameras LOKI and UVP resolve plankton distributions at high vertical resolution (Schulz et al., 2015; Kiko et al., 2017). The main strength of the UVP is detecting marine snow, large-sized single-cell organisms (e.g., Rhizaria; Biard et al., 2016), and gelatinous zooplankton (Stemmann et al., 2008). The resolution of the images (1.5 megapixels with picture size depending on organism size), however, is relatively low and often does not allow for species identification, especially of the dominant zooplankton group Copepoda. The LOKI concentrates the organisms with a net, leading to a flow-through chamber (Schulz et al., 2010). Jellyfish are often destroyed by the net, but LOKI captures Copepoda and other abundant taxa (e.g., Ostracoda, Chaetognatha) in high-quality images, allowing the determination of copepod genera, species, and often developmental stages (Schmid et al., 2016). In addition to in situ imaging, preserved net samples collected during MOSAiC have been scanned using the laboratory on-desk system ZooScan, and single object images have been extracted with the software application ZooProcess (Gorsky et al., 2010). To classify plankton organisms and share images among experts worldwide, all images taken by LOKI, UVP, and ZooScan have been uploaded to EcoTaxa. This web-based platform is an established tool for classifying zooplankton organisms (Picheral et al., 2017) by applying simple machine learning techniques to predict taxonomic categories from image parameters. ZooProcess automatically provides size-related parameters of each object and, in combination with the taxonomic classification, allows for estimating the zooplankton biomass from preserved net samples (Cornils et al., 2022) from the ice-ocean interface to the deep ocean (maximum of 2000 m).

To study the occurrence of squid and fish in the central Arctic Ocean (Snoeijs-Leijonmalm et al., 2022), a continuously recording deep-sea video system (FishCam, MacArtny Germany GmbH, Kiel, Germany) was deployed at 200–400 m water depth. Part of the videos (180 hours) were studied in real-time mode (Snoeijs-Leijonmalm et al., 2022), while an automated procedure for identifying periods of interest (i.e., appearance of large organisms) in the extensive remainder of the video material is currently being developed. The combination of visual techniques, machine learning, and discrete sampling of animals and particulate matter can work together to address long-standing questions on the distributions and controls on these ecosystem components, where few such data are available.

### 2.5.2. Biomarkers and carbon transformations

Biomarkers are molecules (e.g., fatty acids, amino acids, sterols) or isotopic compositions of elements (e.g., carbon) that are somewhat source-specific to primary producers and are incorporated mostly unchanged into the tissue of their consumers. Tracing these biomarkers within the zooplankton and fish community is an essential tool in food web studies that address the relative importance of different sources of organic matter, the role of key Arctic primary producers, and the nutritional status of higher trophic levels (Leu et al., 2020; Kunisch et al., 2021; Kohlbach et al., 2022; Schmidt et al., 2024). Compared to

previous studies, trophic marker analyses of the MOSAiC samples represent improvements in two major aspects. First, a very broad range of trophic markers is being explored, including fatty acids, sterols, highly branched isoprenoids, bulk stable isotope compositions, fatty acid-specific stable isotope compositions, and essential amino acid-specific stable isotope compositions, to balance the strengths and shortcomings of the individual approaches. Second, all the different trophic markers are measured from the same parent samples of homogenized animal tissue to allow a direct comparison of the results and to link the nutritional status of the animals to their food resources. Alongside the trophic marker approaches, animals were also collected for DNA sequencing of gut contents. This approach provides a high taxonomic resolution of the ingested species and will further support the interpretation of the trophic marker data (Cleary, 2015).

One key objective for studying Arctic marine food webs is to elucidate the role of ice algae as a source of organic matter. Trophic biomarkers determined across the food web, including the particulate organic matter in surface waters and ice cores, as well as zooplankton, will help to identify seasonally varying food web interactions from primary producers to individual zooplankton species. These food web interactions will be linked to primary and bacterial production rates as well as vertical flux studies to enable more complete insights into the Arctic ecosystems.

### 2.5.3. Ecological modeling

A variety of bioinformatic and statistical modeling techniques are being applied to MOSAiC data to elucidate changes in composition and metabolic potential of Arctic marine microbial communities with the aim to improve our understanding of their influence on global biogeochemical cycles. A mechanistic understanding of ecological patterns is based initially on information from gene sequences combined with a descriptive approach of community members using co-occurrence networks that illustrate the occurrence of species at the same place and time (Popa et al., 2020). This graphical approach, in which nodes are species and edges represent the correlation strength of their seasonality patterns, enables identification of (i) central species (node hubs) and (ii) species communities (network clusters) that are defined by several populations which are abundant in the same time period (Berry and Widder, 2014). The outcome of such studies allows us to investigate the seasonality of microbial community composition, activities, and functions. It also enables the identification and definition of yet unknown ecological processes. These processes include the interaction of present species with each other and the environment. To understand this interaction in detail and especially to identify key parameters with strong impact on the Arctic ecology, combining all measured data into a modeling framework is necessary (Faust and Raes, 2012). For example, the co-occurrence information of photoautotrophic species with grazers isolated from the ice and water column combined with environmental parameters like water depth, temperature, daylight, and so on can be modeled using a Lotka-Volterra framework (Lotka, 1920;



Volterra, 1927) with a seasonal forcing approach (Vandermeer, 1996; Sauve et al., 2020). As a result, these models can be used to test several species interaction scenarios after varying the environmental parameters (Succurro and Ebenhöf, 2018). Furthermore, extending the Lotka-Volterra framework by the dynamics of the available resources within the ecosystem (MacArthur consumer-resource models; MacArthur, 1970; Goldford et al., 2018) permits the development of a powerful, theoretical tool to explain the formation and occupation of ecological niches in dependence on external parameters with predictive capabilities for several future scenarios.

Data on microbial community structure and metabolic potential are also being leveraged for biogeochemical predictions using machine learning. These techniques are well suited to complex, high dimensional, community structure data and can be used to extract patterns of succession and biogeochemical signatures from sequence information (Bowman, 2021). For example, the Random Forest regression model is effective at predicting biogeochemical signatures from amplicon sequence data, providing the potential for extending the data coverage of less frequently sampled key biogeochemical variables (Dutta et al., 2022). Potential microbial drivers for these processes can be identified by applying permutation to the Random Forest models to assess the contributions of specific community members to model performance (DiMucci et al., 2018). Self-organizing maps are used to partition the microbial community into functionally distinct modes that can be applied as discrete variables in a variety of statistical (Bowman et al., 2017) and mechanistic models (Kim et al., 2022). These discrete variables reflect key genetic traits of the microbial community, provide reasonable estimates of physiology, and allow for correlation between variability in taxonomic structure and function. Eco-physiological information can then be used to modify and better parameterize data-assimilative marine biogeochemical models for hypothesis testing and in silico experimentation—such as quantifying previously identified questions regarding microbial controls on ecological processes and assessing the sensitivity of carbon flow through the microbial food web to climate change scenarios.

### 3. Collected data and current status

The aim of this section is to set the scene for all current and future studies of MOSAiC Ecosystem data by providing the background information to use and interpret individual or combined datasets. The MOSAiC Ecosystem work program generated >50,000 unique samples and activity measurements characterizing organisms and processes from viruses to fish. We sampled 195 CTD rosette casts, 44 multi-nets, and 21 FYI and 20 SYI common ice coring events. We also collected samples from >40 time points and sites during events and IOPs covering a complete Arctic seasonal cycle. A majority of sampling events were co-located in time and space or spanned long periods of continuous measurement and/or sample collection (**Figure 6**). Vertical distributions of most properties in the upper 400 m of the water column were resolved over the

drift, and when possible full water column depth profiles of core properties were collected at once-weekly intervals (**Figure 7**). The resolution of the year-long observations to map essential ecosystem properties differed depending on complexity of sampling and needed volumes; for example, nutrient sampling could be executed more frequently and with greater vertical resolution (**Figure 7A and B**) than total DNA sampling (**Figure 7C and D**). Biodiversity was sampled on different levels of detail, ranging from DNA-based omics approaches (see Mock et al., 2022 for details) to microscopy-based identification of single individuals (examples of species observed during MOSAiC are illustrated in Figures S1 and S2).

#### 3.1. Setting the scene—Environmental controlling factors over the drift period

The MOSAiC expedition provided a wealth of environmental observations from ice, ocean, and atmosphere, including data collected by the ECO team (e.g., macronutrients) to understand ecosystem dynamics and functions. These data provide a critical context to interpret the biological observations during the drift period. An evaluation of the meteorological conditions during the MOSAiC drift indicates that unusually cold temperatures relative to decades-long climatology occurred in November 2019 and March 2020 (Rinke et al., 2021). Rinke et al. (2021) also identified that the 2019–2020 drift year had more frequent storm events in spring and that summer had a longer sea-ice melt season, from late May to early September, approximately a month longer than the median from 1979 to 2019. Also, relative to climatology, the July and August 2020 period was the all-time warmest.

Throughout winter, RV *Polarstern* drifted in northerly directions, with the northernmost location at 88.6°N reached at the end of February 2020. Throughout spring and summer, the floe drifted in southerly directions, with periods of faster (mid-March to mid-April) and slower (mid-April to mid-July) drift speeds. The annual changes in air and water temperature, surface ocean salinity, incoming photosynthetically active radiation (PAR), and surface ocean nutrient concentrations along the drift track are illustrated in **Figure 9**. These properties are relevant examples of environmental changes over the annual cycle that potentially influence ecosystem processes. Air temperatures at 2 m (**Figure 9B**) varied between values as low as  $-40^{\circ}\text{C}$  in March and up to  $6^{\circ}\text{C}$  during the summer months (Shupe et al., 2022; Cox et al., 2023b), driving sea-ice freeze-up and melt (Nicolaus et al., 2022b; Salganik et al., 2023). Upper water column (10 m depth) temperatures (**Figure 9C**) were much less variable, with average daily temperatures near the freezing point during most of the year. Except for the transit periods, maximal temperatures of about  $-1.3^{\circ}\text{C}$  were reached at the end of July. Surface ocean salinity (**Figure 9C**) reflected drift location (Rabe et al., 2022; Schulz et al., 2024), with rather low levels during drift in the TPD in winter 2019–2020. In February and March, TPD influence was gradually replaced by an increasing contribution of more saline Atlantic-influenced waters. After crossing the Gakkel Ridge in late March, average daily surface salinity remained high until

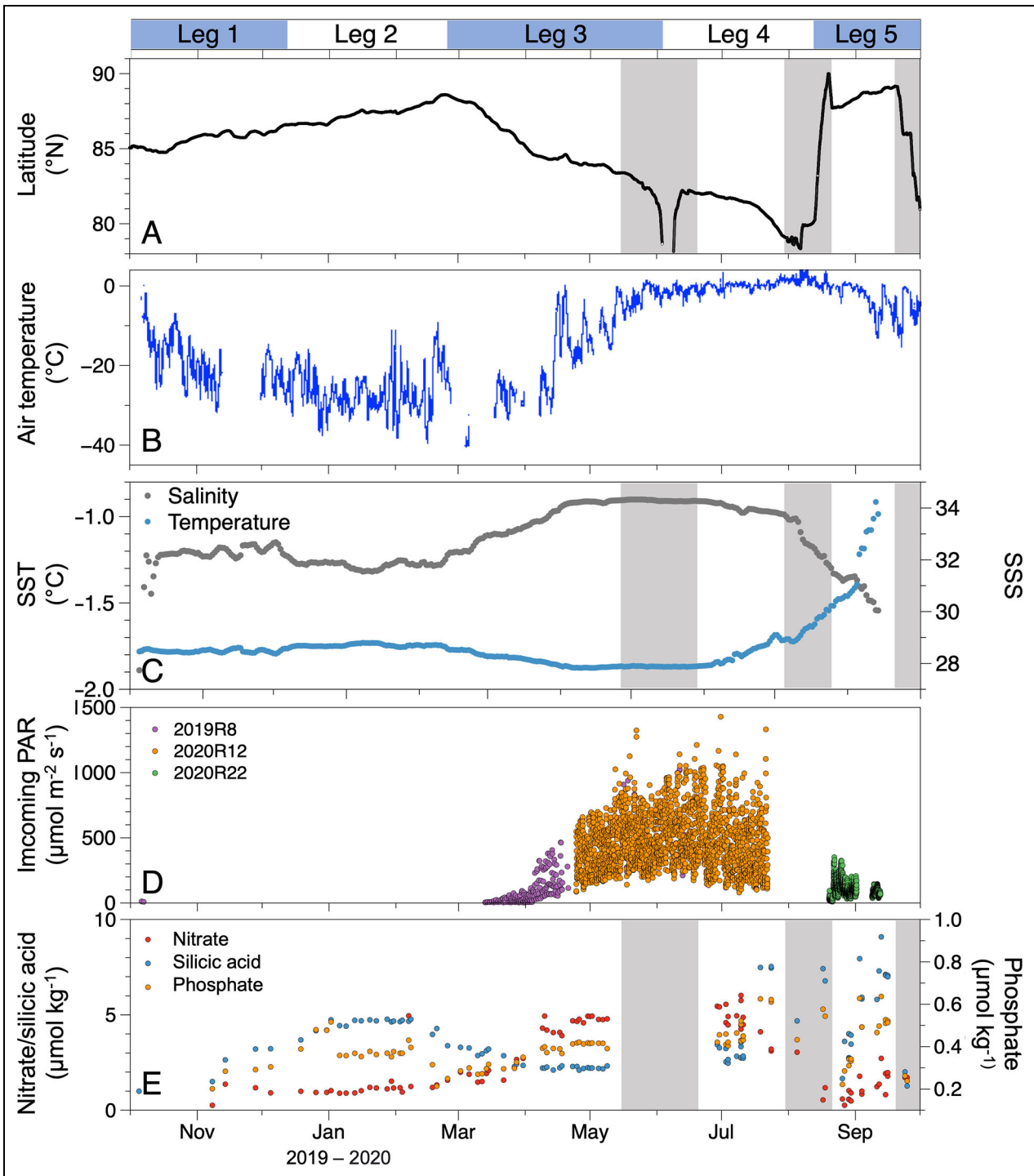

**Figure 9. Environmental conditions over the annual cycle of the drift year.** (A) Latitude (°N), (B) air temperature at 2 m height, (C) sea surface temperature (SST, blue) and salinity (SSS, gray) at 10 m depth, (D) incoming photosynthetically active radiation (PAR; 400–700 nm, measured as photon flux density) from three different radiation stations on the MOSAiC floes (and CO<sub>3</sub>; 2019R8 in pink in CO<sub>1</sub>, 2020R12 in orange in CO<sub>1</sub> and CO<sub>2</sub>, and 2020R22 in green in CO<sub>3</sub>), and (E) surface ocean nutrients (nitrate + nitrite, silicic acid, and phosphate) from all samples collected from the upper 30 m of the water column. Gray-shaded areas indicate transit periods. Here, latitude and nutrients are from the location of RV *Polarstern*, while surface air temperature, water temperature, and PAR are representative of the respective central observatory conditions.

reaching the ice edge in Fram Strait, with stronger influence of lower salinity waters from the polar waters of the East Greenland Current during July 2020 (Schulz et al., 2024).

Incoming solar irradiance (**Figure 9D**), shown as PAR, at the surface of the sea ice decreased quickly in fall and was below the detection limit from October 8, 2019, until March 13, 2020, marking the period of the polar night.

Surface PAR increased as the solar elevation increased and reached maximal values of  $>1300 \mu\text{mol photons m}^{-2} \text{s}^{-1}$  from May to July (note the data gap between mid-July and mid-August). Thereafter, PAR decreased again, with daily maximum values below  $200 \mu\text{mol photons m}^{-2} \text{s}^{-1}$  at the end of the drift.

Nutrient concentrations in surface waters (upper 30 m) varied with water masses and through the seasons as the floe drifted (**Figure 9E**). As the floe drifted northward, silicic acid and phosphate concentrations increased from November to January, from  $1.5 \mu\text{mol kg}^{-1}$  to  $4.7 \mu\text{mol kg}^{-1}$  and  $0.19 \mu\text{mol kg}^{-1}$  to  $0.52 \mu\text{mol kg}^{-1}$ , respectively. Nitrate remained mostly constant at a mean (and standard deviation) of  $1.03 \pm 0.27 \mu\text{mol kg}^{-1}$  ( $n = 17$ ) until February. Silicic acid was also nearly constant until early February, but phosphate concentrations dropped to  $0.35 \mu\text{mol kg}^{-1}$  after early January. Trends diverged further thereafter as the drift continued southward, with nitrate and phosphate increasing to  $4.7 \mu\text{mol kg}^{-1}$  and  $0.42 \mu\text{mol kg}^{-1}$ , respectively, in May, and silicic acid decreasing to  $2.5 \mu\text{mol kg}^{-1}$ . These opposing trends for the different nutrients likely reflect characteristics of the different water masses as distinguished using the temperature and salinity observations, with increasing influence of Atlantic waters containing relatively more nitrate and phosphate and less silicic acid. When sampling at the floe resumed in the second half of June, maximum seawater nitrate, silicic acid, and phosphate concentrations of  $6.0 \mu\text{mol kg}^{-1}$ ,  $7.5 \mu\text{mol kg}^{-1}$ , and  $0.66 \mu\text{mol kg}^{-1}$ , respectively, were measured. Toward the end of August, however, as the drift continued southwestward, nitrate levels quickly decreased to  $<0.5 \mu\text{mol kg}^{-1}$ , while phosphate ( $0.58 \mu\text{mol kg}^{-1}$ ) and silicic acid ( $7.8 \mu\text{mol kg}^{-1}$ ) remained comparably high. This pattern is consistent with polar waters of the East Greenland Current in Fram Strait, with more influence of silicic acid-rich Pacific-derived waters and/or the Transpolar Drift. Thereafter, nutrient concentrations were variable, with ranges of approximately  $0.5\text{--}2 \mu\text{mol kg}^{-1}$  nitrate,  $1\text{--}9 \mu\text{mol kg}^{-1}$  silicic acid, and  $0.2\text{--}0.7 \mu\text{mol kg}^{-1}$  phosphate over the summer and fall, as RV *Polarstern* repositioned on a new floe close to the North Pole.

### 3.2. Observations on ecosystem processes in diverse and ephemeral habitats

While consistent year-round MOSAiC ECO observations were planned for water column and level sea ice (both FYI and SYI), a series of other ephemeral or special habitats was also studied. Based on opportunistic sampling, we observed ecosystem processes in various other sea-ice types, resulting from different formation processes (**Figure 10**). Summer season sampling in leads (**Figure 10A and B**) and water close to the bottom of the ice provided further insight into how ice dynamics and ephemeral phenomena and events may alter biological responses over timescales missed by our regular weekly sampling. This opportunistic sampling indicated the formation of extremely high biomass layers on the boundary between meltwater and seawater, with distinct composition and biogeochemical characteristics (Smith et al., 2023). New ice formations, typically ranging from 1 cm to 10 cm in

thickness, and those from loosely formed crystals to consolidated nilas ice, were sampled periodically throughout the drift, primarily from leads near or across the central floe (**Figure 10C and D**), with preliminary data indicating higher organismal abundances and Chl-*a* concentrations than the surrounding seawater (data not shown, but see **Figure 10H**). Our series of samples of newly formed ice at different time periods over the annual cycle will provide us with complementary data on how environmental conditions (**Figure 9**) influence biological and ecological processes during initial thermodynamic ice formation. Sea-ice ridges (**Figure 10G and H**) were also sampled periodically for biological properties and vertical export of material during MOSAiC.

Level (undeformed) sea ice provides a wide range of niches for ice-related organisms, ranging from biota living in the brine channel systems within the ice to under-ice flora and fauna living at the ice-water interface (Lund-Hansen et al., 2020). These level sea-ice systems are being studied in detail using the ICE and ECO time series (see also Nicolaus et al., 2022b). However, deformed sea ice in pressure ridges adds substantial three-dimensional diversity in the available habitat space through voids filled with seawater between ice blocks (often referred to as rubble) in the ridge keels. Ridge keels in the Arctic can reach substantial ice drafts exceeding 20 m keel depth (Wadhams and Toberg, 2012), making ridge coring or observations of voids within ridges exceptionally challenging. Sporadic observations from previous Arctic studies suggested unique biological hotspots associated with the water-filled voids in unconsolidated keel rubble and ice block surfaces within the pressure ridges (Syvertsen, 1991; Gradinger et al., 2010; Fernández-Méndez et al., 2018). Ridges might become increasingly important in future sea-ice scenarios by providing habitat diversity under first-year ice conditions (Hop et al., 2021). During MOSAiC, ridges were studied as habitats by examining the relationship between ridge structure and biological properties (e.g., algal and microbial diversity in ice and void water), under-ice hyperspectral imaging of algal biomass distribution along the pressure ridge keels, and vertical particle flux in the proximity of the ridges using sediment traps. Upcoming analyses will focus on comprehensive characterizations of ridge properties (e.g., using time series data) and will be compared to those from level ice and under-ice seawater samples. This will help to assess how ridge biodiversity and ecosystem functioning are driven by this specific physical habitat.

Consistent with previous research (Gradinger, 1996; Mundy et al., 2011), initial observations of meltwater layers during MOSAiC suggest that their presence represents a drastic change in the environmental and chemical nature of the upper ocean (Smith et al., 2022), which in turn can be expected to elicit changes in biological properties and activities. Stratification in the upper 1–2 m of the ocean creates a strong gradient and boundaries which most organisms are unable to cross, thus creating small microhabitats within each of these layers. These adjacent layers may support potentially disparate activity



**Figure 10. A variety of seawater and sea-ice habitats sampled over the drift year.** (A) Frost flowers developing on a refrozen lead on March 11, 2020; (B) sampling an open lead on July 22, 2020; (C) new ice formation on a lead located near ECO Lodge 2 on September 07, 2020; (D) sampling new ice and direct under-ice waters from a lead located near ECO Lodge 2 on September 12, 2020; (E) underwater photos of ice blocks within an open lead on July 01, 2020, and (F) from the same location on July 29, 2020, showing the development of thin, stratified fresh and brackish layers within leads; (G) Jaridge Observatory from the surface with piled up ice blocks on June 26, 2020; (H) underwater photo of ice blocks in Jaridge Observatory (see **Figure 4**) with strands of *Melosira*; (I) refrozen surface of a melt pond showing large aggregate material through the ice surface on August 21, 2020; and (J) melt pond sampling on August 31, 2020.



rates, standing stocks, and biogeochemical fluxes despite their close spatial relation. As such, meltwater layers may introduce habitat structuring which greatly impacts ecosystem functioning. Furthermore, meltwater layer formation affects the gas exchange process with the atmosphere, such that a meltwater layer at the surface may lead to the equilibrium of gases with the atmosphere, thereby reducing the gradient of concentration with the atmosphere and the flux (von Appen et al., 2021; Smith et al., 2023). The mixing of meltwater and the underlying seawater during summertime potentially produces water with low CO<sub>2</sub> concentration.

**3.3. Gaps in time series measurements**

Overall, the MOSAiC ecological field program captured a large number of co-located properties at a regular frequency. However, with differing competencies across each field team, and despite efforts to cross-train and build redundancy in skill sets, there are some gaps in the ecosystem time series measurements. While risk assessments and prioritization schemes were devised, execution in the field was determined by what could be achieved by the field team, and different factors at different times contributed to variations in the continuity of specific datasets. Here and in **Figure 11**, we outline

the key gaps in measurements, so that future users of MOSAiC ECO datasets can easily identify when in the annual cycle certain measurements are not available. Activity rate measurements, such as primary and bacterial production, only began in January and late December 2019, respectively. Samples for water column DOM characterization after solid-phase extraction are only available from April, May, August, and September 2020. <sup>15</sup>N-nitrate isotope samples from sea ice were collected from December 2019 onward. RNA samples from bottom portions of sea ice are only available from April 2020 onward. There were no daily discrete sample collections for Chl-*a* and microbial community structure from December 2019 to the end of February 2020. Likewise, MIMS data from December 2019 to the beginning of March 2020 are of substantially lower reliability compared to the rest of the drift.

**3.4. Current status and major achievements**

MOSAiC ECO sample and data analyses are still ongoing, with new and exciting data and scientific findings expected to emerge over the next decade. Nevertheless, some major achievements can already be identified, some of which may lead to a step-change in understanding of the “whos, hows, and whys” of the high Arctic marine ecosystem:

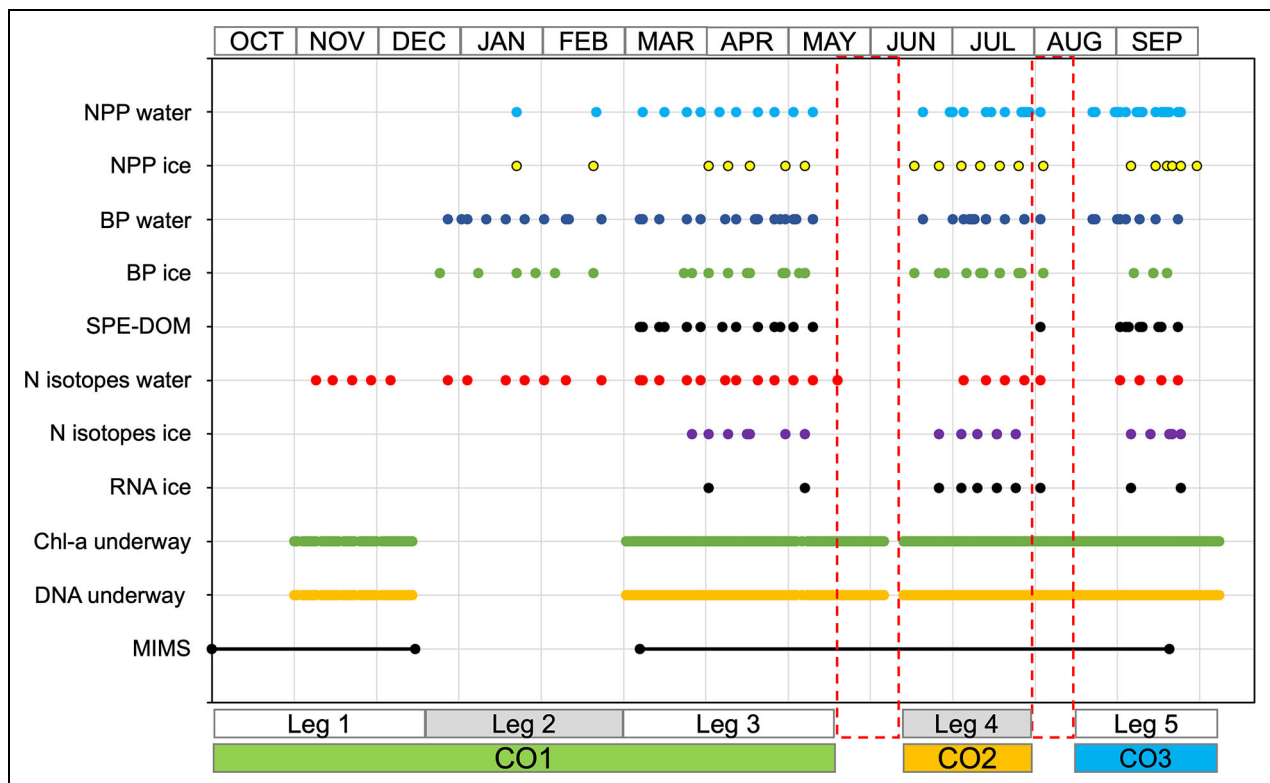

**Figure 11. Gaps in sample collection for different ECO parameters.** Each row shows the dates of a sampling event for a specific type of sample. Solid lines indicate instrumentation deployed through the ice for a continuous period. Alternating white and gray horizontal bars at the bottom of the chart indicate the MOSAiC leg. Colored horizontal bars indicate from which Central Observatory (CO) the samples were collected. Dashed red line boxes identify the periods when RV *Polarstern* was transiting to/from an ice floe. NPP indicates net primary production; BP, bacterial production; SPE-DOM, solid phase extraction of dissolved organic matter; MIMS, membrane inlet mass spectrometer.



- Collection of the largest number of samples to assess biodiversity at a high spatiotemporal resolution in the central Arctic Ocean will enable a comprehensive ecosystem description from viruses to fish and squid for all seasons along the drift.
- Observations of unprecedentedly high winter standing stocks and activity levels of organisms in the largely unstudied polar night will strongly elevate our understanding of overwintering mechanisms in the high Arctic Ocean.
- Biological measurements in a diverse range of seasonally occurring habitats will provide in-depth characterizations of biological hotspots (e.g., pressure ridges, meltwater layers).
- Rate measurements of key biological processes (e.g., primary production, bacterial production, zooplankton grazing and respiration rates) throughout all seasons will provide a crucial foundation for the parameterization of biogeochemical and food web models over a complete annual cycle.
- The largest sequencing effort for polar ecosystems will provide a benchmark for biodiversity change (Mock et al., 2022).
- Comparison of MOSAiC ECO data from the central Arctic Ocean with those previously collected in Arctic shelf areas gives a new opportunity to unveil regional patterns and a mechanistic understanding of the driving factors (Schmidt et al., 2024), aiming toward a pan-Arctic understanding.
- Cross-cutting analysis revealed that central Arctic biological processes can affect atmospheric chemical composition during the melt season (Yue et al., 2023) and have the potential to impact cloud processes (Creamean et al., 2022).
- The support of a large and diverse suite of MOSAiC ECO projects covering either a particular season or environment, or a full year, will lead to a wealth of knowledge on specific aspects of species biology and ecology, and a better understanding of seasonal changes in these aspects.

The co-located, in-depth characterization of environmental conditions enabled by the interdisciplinary character of MOSAiC allows to link biological observations to abiotic driving factors (e.g., for rapid transitional periods that are hard to predict in terms of timing) and, in turn, to determine when biological interactions are likely the main driving force of ecosystem dynamics (Behrenfeld, 2010). As one example, macro-nutrients represent major controlling factors of Arctic productivity (Tremblay et al., 2015; Randelhoff et al., 2020) and are therefore key to understanding seasonal dynamics. Our macro-nutrient data indicate strong spatial differences between water masses along the drift (**Figure 9**; Schulz et al., 2024) that dominate variability due to potential signals of seasonal uptake and limitation dynamics. The presence of surface ocean nitrate concentrations around  $2 \mu\text{mol kg}^{-1}$  at the end of summer and into fall at  $>84^\circ\text{N}$  warrant close inspection concerning the dynamics of supplying nutrients to the sunlit layers, as these concentrations potentially indicate

iron limitation of primary production in Nansen Basin (Rijkenberg et al., 2018). This potential could lead to a paradigm shift in our understanding of Arctic primary production (Wassmann and Reigstad, 2011; Tremblay et al., 2015; Ardyna and Arrigo, 2020). The large imprint that water masses had on important environmental drivers such as nutrient concentrations illustrates that many statements about the Arctic cannot be generalized but need to be region specific.

Disentangling spatial and temporal scales of different environmental controls is also important. For example, the omega-3 fatty acid composition of particulate organic matter in the water column and sea ice was shown to depend on a combination of environmental controls (irradiance, nutrients), rather than habitat type or species composition (Schmidt et al., 2024). By combining data from MOSAiC, other Arctic expeditions and experimental work on Arctic primary producers, this study (Schmidt et al., 2024) sets an example on how to place our results into a pan-Arctic context in the future. As another example, a diverse and abundant mesozooplankton community was observed over the entire MOSAiC campaign. We have so far identified as many as 46 calanoid copepod taxa in the central Arctic Ocean. Ongoing analyses focus on the interplay between seasonal (**Figure 9**) as well as regional patterns (**Figure 1**) to decipher the seasonally resolved biogeography of different species. While we are of course not the first ones to study zooplankton dynamics in the central Arctic Ocean (Kosobokova and Hirche, 2000; Ashjian et al., 2003; Ershova et al., 2021), until MOSAiC there had been no direct year-round measurements of *Calanus*-related food web dynamics in this region. This task is complex and challenging, as evaluating the importance of mesozooplankton-mediated transformations and fluxes of energy, carbon and nitrogen requires quantifying both standing stocks and rate processes as well as understanding zooplankton diet in relation to food abundance. It was achievable within the MOSAiC framework only through the tight collaboration of several science teams providing time series data of ocean and sea-ice physical properties and food availability (microalgae and microzooplankton abundances and standing stocks), as well as quantifying mesozooplankton standing stocks and distributions.

The interdisciplinary approach of MOSAiC will also allow us to better parameterize and map cross-disciplinary linkages that may not be obvious a priori. For example, sea-ice algae might change the energy absorption of ice and ocean (Manizza et al., 2013), thereby affecting Arctic heat budgets along the atmosphere-ice-ocean continuum (Shupe et al., 2022). New tools such as hyperspectral imagers deployed on remotely operated vehicles may enable comprehensive mapping of ice algae and potentially facilitate improved quantitative evaluation of biological effects on ice transmission and heat budgets.

Comprehensive studies of a number of periodically occurring habitats, for example, meltwater-influenced systems and pressure ridges, found them to be biological hotspots. Unique habitat-specific processes may provide major additions to fluxes of energy and matter; thus, their quantification is needed for a complete view on high

Arctic biogeochemistry and ecology. Our data will allow us to evaluate the relative role of these short-lived hotspot habitats compared to the perennial habitats such as level sea ice. Several of these habitats develop during the summer season only (e.g., melt ponds, meltwater layers, unconsolidated water-filled voids in pressure ridges) but may affect organismal life strategies during different periods of the annual cycle. While these features form primarily during the summertime, their altered states can persist into later seasons and even the following year. For example, remnants or “fingerprints” of these hotspots may be identifiable, such as refrozen melt ponds or refrozen (consolidated) voids in ridges, and characterized during the winter season as overwintering habitats for a range of Arctic organisms.

#### 4. Linkages, perspectives, and scientific impacts

##### 4.1. Challenges and lessons learned

MOSAiC observations and samples were conducted year-round, often in challenging conditions. This effort frequently required both adapting standard ship and on-ice operations and team operations and adjusting science objectives. Given the major focus of MOSAiC on interactions between atmosphere, sea ice, and ocean, we intentionally limited our work program to focus on the ecological and biogeochemical components that are relevant for the sea ice and upper ocean, excluding the deepest water layers and the seafloor. Additionally, in an effort to focus on measurements that would elucidate biological feedbacks in the Arctic climate system, we did not include observations of megafauna, such as sea birds and mammals, although they provide important ecosystem services and are highly impacted by climate change (Hamilton et al., 2022).

Some unique challenges that we addressed in the preparation phase were related to potential impacts of the anticipated long-term drift on the collection of scientific data. Key adaptations were made in conjunction with other science teams and the ship's crew (see Section 2.4 for details). Additionally, during the preparation phase, we took steps to train and prepare field personnel to execute a variety of tasks and protocols encompassing a broader range of activities than they would have been responsible for within an expedition of narrower scope than MOSAiC. Building competencies and redundancies in the skill sets of field personnel was important to realizing the diverse work program. However, it was not always possible, and in some instances gaps in our time series measurements exist because accomplishing all the tasks was not feasible for the field team (see Section 3.4). Additional modifications were necessary onboard based on expected irregular disturbances (e.g., storms, ice break-up) as well as unexpected events (e.g., the COVID-19 outbreak). In the future, improved prioritization of sample collections, development of more semi-automated sampling and processing devices, and increased training on unfamiliar data-logging routines will strengthen execution of complex work programs. Our experience with MOSAiC ECO work will also provide us with the opportunity to better determine

which suites of properties are most needed for addressing future questions and objectives related to changes in the high Arctic marine ecosystems.

Our data analyses will need to disentangle temporal versus spatial aspects of observed changes in biological properties and ecological processes over the course of the drift. This need is nicely illustrated by the development of nitrate concentrations over the course of the expedition (**Figure 9E**). Even though nitrate is considered one of the two major limiting factors for Arctic primary production (Tremblay et al., 2015), its concentrations increased over the main microalgal growing season, that is, from March to July. While perhaps counterintuitive at first, this increase can be explained by the drift of the ice floe into areas with increasingly larger influence by nitrate-rich Atlantic water masses (Rabe et al., 2022; Schulz et al., 2024). Such water mass effects also influence other measured parameters such as DOM characteristics (Gonçalves-Araujo et al., 2016; Kong et al., 2024), and potentially the presence or absence of certain groups and species of organisms (Kaiser et al., 2022). Also, the faster-than-expected drift speed of the main MOSAiC floe resulted in earlier arrival into Atlantic inflow-influenced waters and proximity to the ice edge, resulting in significant deformation and instability of the first Central Observatory (von Albedyll et al., 2024). Therefore, after the logistical departure in May 2020, the ice camp had to be relocated to a different part of the original ice floe and a second Central Observatory was established. While these aspects are part of the nature of a drift campaign, their influence on how one can interpret our observations is central to our understanding of ecosystem processes during the MOSAiC field year.

##### 4.2. Ecosystem research in the context of Arctic system science

MOSAiC was designed to improve our understanding of the governing principles of the Arctic climate system and its results thus should be used in an Earth system science approach. The need for such improvement is particularly urgent as the Arctic is warming four times faster than the global average (Rantanen et al., 2022). Developing baseline knowledge on the “who,” “how,” and “why” of the high Arctic Ocean was the foundational principle of the MOSAiC ecosystem science program, and the data already demonstrate multiple connections within the ecosystem compartments and to the whole Arctic system, including the presence of INPs of marine biological origin (Creamean et al., 2022) and of atmospheric elemental mercury (Yue et al., 2023). The Arctic Ocean can be both a source and a sink for greenhouse gases, like CO<sub>2</sub> and methane. Annual cycles of fluxes of such substances are currently being investigated in relation to bacterial biodiversity, algal activity, and respiration. For instance, a combination of the broad scope of information from several MOSAiC science teams is expected to help resolve the “ocean methane paradox” and explain periodically enhanced CH<sub>4</sub> concentrations in ocean surface waters (Rees et al., 2022). Great uncertainty exists regarding the future role of the Arctic Ocean as a source or sink for CO<sub>2</sub>, where the

melting of sea ice combined with increased primary production could lead to a regionally intensified sink (Rees et al., 2022), while other Arctic areas might experience a reduction of carbon fixation and export due to increased stratification induced by sea-ice melt (von Appen et al., 2021). Other processes that can potentially lead to CO<sub>2</sub> outgassing by the Arctic Ocean include decreased solubility driven by warmer temperatures, equilibration with the atmosphere (Cai et al., 2010; Else et al., 2013), and wind-driven mixing of surface waters with more carbon-rich subsurface layers (Lannuzel et al., 2020). MOSAiC ECO data will fill important regional and pan-Arctic knowledge gaps in our understanding and may help to determine those mechanisms that will drive the effects of climate change on the Arctic carbon cycle.

A set of different ecosystem and fully coupled Arctic Ocean models will be essential tools for integrating information across the ecosystem and the entire Arctic system using MOSAiC data, targeting not only specific questions like carbon cycling in the Arctic or production of climate-relevant greenhouse gases but also transferring these process-focused knowledge gains into products to understand climate change on larger regional and temporal scales. The *Tara* Oceans Polar Circle expedition pioneered metagenomic and metatranscriptomic work mainly for the shelf areas while circumnavigating the Arctic Ocean (Royo-Llonch et al., 2021). Building on this effort but expanding into the central Arctic Ocean, we collected more samples, by two orders of magnitude, including many from sea ice and over all seasons. The unprecedented increase in knowledge on biodiversity and gene expressions in relation to environmental variables (Mock et al., 2022) will allow for the application of models to elucidate metabolic and energetic fluxes within the Arctic microbial consortia (Succurro and Ebenhöf, 2018). This combined application of different model types will be an important tool to differentiate the intertwined role of spatial and temporal variability in MOSAiC datasets.

## 5. Outlook

The knowledge created by the ecological research during MOSAiC will provide a lasting legacy for future studies focusing on the Arctic System. For the first time, biodiversity and ecosystem functioning were studied on multiple trophic levels over a full seasonal cycle using both traditional and novel approaches.

The legacy of MOSAiC goes beyond publications, the development of novel sampling approaches and the openly accessible data archives. Indeed, the open and growing network of researchers across many nations and disciplines can be expected to have a lasting effect on Arctic marine research, particularly considering the high number of early career scientists who are already involved. New spin-off projects initiated through MOSAiC include projects on microbial processing and biogeochemical modeling, remote sensing of under-ice blooms, sea-ice ecosystem modeling, and a year-round ecosystem study in an Arctic fjord. The gained knowledge will help to evaluate the importance of the Arctic for climate regulation. Although incomplete, several publications have

demonstrated the broad range of currently known ecosystem services provided by the Arctic marine system to human societies including regulation of greenhouse gases and biodiversity (Malinauskaite et al., 2019; Steiner et al., 2021). MOSAiC-based knowledge will also support political decision-making processes, for example, through Arctic Council initiatives on the management of Arctic marine ecosystems (e.g., Protection of the Arctic Marine Environment [PAME]). Although MOSAiC ECO covers a very broad range of ecological topics and will fill many knowledge gaps, many research questions remain unanswered or are now newly defined. The free, findable, accessible, interoperable, and reusable MOSAiC datasets will be a major milestone of success, providing together with the gained knowledge the backbone for interdisciplinary marine Arctic research for decades to come.

The broad range of realized measurements and samples from MOSAiC ECO will make it possible to move from the observed answers of the “who” and “how” to developing a process-based mechanistic understanding of the “why,” including by means of modeling approaches (see below). A mechanistic understanding, in turn, will allow moving beyond the specific locations and conditions during our observational period. The observation of high levels of biomass and biological activity during the months-long cold and dark polar night, for example, provides the foundation for new investigations regarding overwintering mechanisms, strategies, and physiological adaptations. The combination of rate measurements, observations of different life stages, physiological and food web experimental work, as well as information originating from metagenomics and metatranscriptomics, will allow a better understanding of current overwintering mechanisms. It will also provide improved scenarios regarding the potential impacts of a future warmer Arctic with a reduced and changed ice cover, for example, regarding effects on winter survival, annual primary and secondary production, and biogeochemical cycles. Here, synergies between the ECO team and the BGC science with its focus on trace and greenhouse gases, as well as the cycling of sulfur, nitrogen, and carbon will be essential. Entrainment of the detected processes and rates into ecosystem and biogeochemical models will also greatly improve the validity of such future scenario estimations. While a one-year field-period cannot observe climate change trends directly, MOSAiC science brings a step-change to Arctic marine ecosystem understanding, providing a baseline upon which future changes can be identified and the potential for improved projections of future changes based on an advanced process-based interdisciplinary understanding.

## Data accessibility statement

Drift track data for each MOSAiC leg are available via PANGAEA (Haas, 2020; Kanzow, 2020; Rex, 2020; 2021a; 2021b).

Combined surface ocean temperature and salinity data from different sensors as described in Schulz et al. (2024) are available via the Arctic Data Center (Schulz et al., 2023).

Data on air temperature at 2 m over the MOSAiC floe are available at the Arctic Data Center (Cox et al., 2023a).

Incoming PAR data were derived from radiation station measurements published at PANGAEA (Nicolaus et al., 2022a; 2023a; 2023b).

Macro-nutrient data are available via PANGAEA (Torres-Valdés et al., 2024a; 2024b).

Metadata for **Figure 7** is available in Table S8.

### Supplemental files

The supplemental files for this article can be found as follows:

**Table S1.** Project-specific contributions to the ECO work program.

**Table S2.** List of ECO sampling events based on rosette casts and optical particle profiling.

**Table S3.** Overview on sample processing and applied methods.

**Table S4.** Overview of quantitatively analyzed zooplankton sampling events and collected samples.

**Table S5.** List of ECO sampling events for zooplankton and fish sampling.

**Table S6.** List of ECO sampling events for first and second year ice.

**Table S7.** List of ECO sampling events for event driven sampling and intense observation periods (IOPs).

**Table S8.** List of all DNA and nutrient sampling events from the water column.

**Figures S1 and S2.** Examples of observed organismal diversity.

### Acknowledgments

This manuscript is part of the international Multidisciplinary drifting Observatory for the Study of the Arctic Climate (MOSAiC) with the tag MOSAiC20192020 and the Project ID AWI\_PS122\_00. We thank the cruise participants, ship's crew and logistics support as well as everyone else who contributed to the realization of MOSAiC (Nixdorf et al., 2021). This work was supported by the Swedish Polar Research Secretariat as part of the MOSAiC 2019–2020 expedition. Water column nutrient analyses on land were carried out at the AWI Nutrient Facility. L. Heitmann, S. Spahic, T. Brenneis, A. Terbrüggen, G. Guillou, K.-U. Ludwischowski, K. U. Richter, D. Scholz, T. Klüver, J. Roa, and R. Flerus are acknowledged for technical support. S. Tippenhauer, M. Hoppmann, J. Schaffer, and K. Schulz are acknowledged for their help with CTD sampling and data provision. We thank J. Grosse for sampling and measurements on Leg 2. V. Moulton and R. M. Leggett are acknowledged for the help with genomic and transcriptomic analyses. We thank P. Leroy for essential contributions to the sequencing-based characterization of biodiversity. M. Küsting, C. Dybwad, and Y. Nowak are acknowledged for their help with the schematic overview figure. We thank the science journalist M. Göring for her help during Leg 5 field sampling.

### Funding

This work was funded by The German Federal Ministry for Education and Research (BMBF) through financing the Alfred-Wegener-Institut Helmholtz Zentrum für

Polar- und Meeresforschung (AWI) and the Polarstern expedition PS122 under grant N-2014-H-060\_Dethloff and by AWI through its projects: AWI\_ECO, AWI\_BGC, AWI\_ATMO, AWI\_ICE, AWI\_OCEAN, and AWI\_SNOW. AC was supported by the German Ministry for Education and Research (BMBF; Grant 03F0917A MOSAiC 3). The funding for AE and MC was provided by the Helmholtz Association and by the MicroARC project (03F0802A) within the Changing Arctic Ocean program, jointly funded by the UKRI Natural Environment Research Council (NERC) and the German Federal Ministry of Education and Research (BMBF). ALW and HS were funded through the UK Natural Environment Research Council's (NERC) contribution to MOSAiC, grant NE/S002596/1 for the SIMBRICS project. AU received funding from the Swedish Research Council Formas (grant no. 2018-01398) and the Carl Trygger Foundation (grant no. CTS 15:505). BLE was supported by a Fellowship from the Hanse-Wissenschaftskolleg Institute for Advanced Study, Delmenhorst, Germany. CJA and RGC were supported by the U.S. National Science Foundation Office of Polar Programs Arctic Sciences Section awards OPP-1824447 (CJA) and OPP-1824414 (RGC). CHa was supported by the Helmholtz Association and AWI by HYIG ARJEL with the project number VH-NG-1400. CJMH received funding from the German Ministry for Education and Research (BMBF) through the project NiceLABpro (grant no. 03F0867A). DKP received funding from the United States National Science Foundation, NSF-OPP 2138785. DN was supported by the Japan Society for the Promotion of Science (grant numbers JP18H03745; JP18KK0292; JP17KK0083; JP17H04715; JP20H04345), a grant from the Joint Research Program of the Japan Arctic Research Network Center, and the Arctic Challenge for Sustainability II (ArCS II) project. ESD was funded by the UK Natural Environment Research Council (NERC) through the ENVEast Doctoral Training Partnership (NE/L002582/1) and the UK Department for Business, Energy and Industrial Strategy through the UK Arctic Office.

FLS and SS were funded by the Dutch Research Council (NWO) grant 866.18.003, with contributions of the European Commission (EC), European Climate, Infrastructure and Environment Executive Agency (CINEA), Framework Contract EASME/EMFF/2018/003, Specific Contract EASME/EMFF/2018/1.3.2.2/03/SI2.805469, and of the Netherlands Ministry of Agriculture, Nature and Food Quality (LNV) grant WOT-04-009-047.04.

GC was partly funded by the NERC project (NE/R012725/1) Eco-Light, part of the Changing Arctic Ocean programme, jointly funded by the UKRI Natural Environment Research Council (NERC) and the German Federal Ministry of Education and Research (BMBF). KS was funded through the UK Natural Environment Research Council's (NERC) contribution to MOSAiC, the SYM-PEL project (NE/S002502/1).

JB, BLo, and EJC were supported by the National Science Foundation under the grant no. NSF-OPP 1821911. JMC, TCJH, KRB, and CM were supported by the Department of Energy's Atmospheric Radiation Measurement (DOE ARM) User Facility (grant #: DE-AC05-76RL01830)

and DOE's Atmospheric Systems Research (DOE ASR) Program (grants #: DE-SC0019745 and DE-SC0022046). JS, MAVL, and DB were supported by the Dutch Research Council (NWO), through the Netherlands Polar Programme (NPP), Project no. 866.18.002. MAG, RRG, AL, EL, GB, NA, PA, BAL, ES, JG, LMO, and OM were supported by the Research Council of Norway (RCN) through the project HAVOC (grant no. 280292). MAG and BAL were also supported by the RCN through the project CAATEX (grant no. 280531) and ES by RCN project INTERAAC (grant no. 328957). MAG was also supported through the European Union's Horizon 2020 research and innovation program project ARICE (EU grant no. 730965). MDS was funded by the National Science Foundation (OPP-1724551) and the NOAA Physical Sciences Laboratory (NA22OAR4320151). MO was funded by the U.S. National Science Foundation under award number OPP-1735862. OE and EO were supported by the Deutsche Forschungsgemeinschaft (DFG) under grant number EB 418/6-1 (From Dusk Till Dawn) as well as Germany's Excellence Strategy—EXC-2048/1—project ID 390686111.

PSL, SB, MB, SLE, JPB, and AT were supported by the Swedish Research Council VR (2018-04685), the Swedish Research Council Formas (2018-00509), and the Swedish Polar Research Secretariat (2019-153). PSL, SB, HF, BN, NH, CEG, SS, FLS, MB, AS, and MV were supported by the European Commission (EASME/EMFF/2018/003) and the Swedish Polar Research Secretariat (2019-153). STV and BRa received funds from the Changing Arctic Ocean (CAO) program, jointly funded by the United Kingdom Research and Innovation (UKRI) Natural Environment Research Council (NERC) and the Bundesministerium für Bildung und Forschung (BMBF), in particular, the CAO projects Advective Pathways of nutrients and key Ecological substances in the ARctic (APEAR) grants NE/R012865/1, NE/R012865/2, and #03V01461, and the project Primary productivity driven by Escalating Arctic NUTrient fluxes (PEANUTS) grant# 03F0804A. TM received funding from the U.S. Department of Energy (DOE) Joint Genome Institute (10.46936/10.25585/60001271, DE-AC02-05CH11231), the Natural Environment Research Council UK (NE/S002596/1, NE/S007334/1, NE/K004530/1, NE/R000883/1, NE/R012644/1) and the Leverhulme Trust (RPG-2017-364). We acknowledge support by the Open Access Publication Funds of Alfred-Wegener-Institut Helmholtz Zentrum für Polar- und Meeresforschung.

### Competing interests

All authors declare that they have no competing interests.

### Author contributions

Developed the concept and design: AAF, CJMH, and RRG with input from co-authors.

Conceived and coordinated the research: AAF, CJMH, CJA, PA, DCEB, SB, JB, GB, RGC, MC, JMC, ED, KD, AE, HF, AF, SF, MAG, MG, CHa, CHe, HJ, BPK, AK, AL, BL, BLo, WM, KM, TM, MN, BN, EMN, DKP, BRa, MR, AR, BRo, HS, KS, MDS, PSL, JS, STV, MAVL, MV, RRG.

Conducted the field sampling: AAF, CJMH, CJA, YB, JPB, JB, DB, RGC, GC, EJC, JMC, ESD, SLE, AF, JG, CEG, NH, AI,

BAL, KM, OM, DN, LMO, SR, SS, ES, KS, KMS, PSL, JS, AS, STV, AT, AU, ALW, YZ.

Drafted and revised the article: AAF, CJMH, and RRG with contributions from all co-authors.

Approved the submitted version for publication: All co-authors.

### References

- Alfred-Wegener-Institut Helmholtz-Zentrum für Polar- und Meeresforschung.** 2017. Polar research and supply vessel POLARSTERN operated by the Alfred-Wegener-Institute. *Journal of Large-Scale Research Facilities* **3**: A119. DOI: <http://dx.doi.org/10.17815/jlsrf-3-163>.
- Angelopoulos, M, Damm, E, Simões Pereira, P, Abrahamsson, K, Bauch, D, Bowman, J, Castellani, G, Creamean, J, Divine, DV, Dumitrascu, A, Fons, SW, Granskog, MA, Kolabutin, N, Krumpfen, T, Marsay, C, Nicolaus, M, Oggier, M, Rinke, A, Sachs, T, Shimanchuk, E, Stefels, J, Stephens, M, Ulfsbo, A, Verdugo, J, Wang, L, Zhan, L, Haas, C.** 2022. Deciphering the properties of different Arctic ice types during the growth phase of MOSAiC: Implications for future studies on gas pathways. *Frontiers in Earth Science* **10**: 864523.
- Ardyna, M, Arrigo, KR.** 2020. Phytoplankton dynamics in a changing Arctic Ocean. *Nature Climate Change* **10**(10): 892–903. DOI: <http://dx.doi.org/10.1038/s41558-020-0905-y>.
- Ardyna, M, Mundy, CJ, Mills, MM, Oziel, L, Grondin, P-L, Lacour, L, Verin, G, van Dijken, G, Ras, J, Alou-Font, E, Babin, M, Gosselin, M, Tremblay, JE, Raimbault, P, Assmy, P, Nicolaus, M, Claustre, H, Arrigo, KR.** 2020. Environmental drivers of under-ice phytoplankton bloom dynamics in the Arctic Ocean. *Elementa: Science of the Anthropocene* **8**(1): 30. DOI: <http://dx.doi.org/10.1525/elementa.430>.
- Ashjian, CJ, Campbell, RG, Welch, HE, Butler, M, Van Keuren, D.** 2003. Annual cycle in abundance, distribution, and size in relation to hydrography of important copepod species in the western Arctic Ocean. *Deep Sea Research Part I: Oceanographic Research Papers* **50**(10–11): 1235–1261. DOI: [http://dx.doi.org/10.1016/S0967-0637\(03\)00129-8](http://dx.doi.org/10.1016/S0967-0637(03)00129-8).
- Assmy, P, Fernández-Méndez, M, Duarte, P, Meyer, A, Randelhoff, A, Mundy, CJ, Olsen, LM, Kauko, HM, Bailey, A, Chierici, M, Cohen, L, Doulgeris, AP, Ehn, JK, Fransson, A, Gerland, S, Hop, H, Hudson, SR, Hughes, N, Itkin, P, Johnsen, G, King, JA, Koch, BP, Koenig, Z, Kwasniewski, S, Laney, SR, Nicolaus, M, Pavlov, AK, Polashenski, CM, Provost, C, Rösel, A, Sandbu, M, Spreen, G, Smedsrud, LH, Sundfjord, A, Taskjelle, T, Tatarek, A, Wiktor, J, Wagner, PM, Wold, A, Steen, H, Granskog, MA.** 2017. Leads in Arctic pack ice enable early phytoplankton blooms below snow-covered sea ice. *Scientific Reports* **7**(1): 40850. DOI: <http://dx.doi.org/10.1038/srep40850>.



- Babin, M, Arrigo, K, Bélanger, S, Forget, M-H.** 2015. Ocean colour remote sensing in polar seas. International Ocean Colour Coordinating Group (IOCCG). DOI: <http://dx.doi.org/10.25607/OBP-107>.
- Balmonte, JP, Teske, A, Arnosti, C.** 2018. Structure and function of high Arctic pelagic, particle-associated and benthic bacterial communities. *Environmental Microbiology* **20**(8): 2941–2954. DOI: <http://dx.doi.org/10.1111/1462-2920.14304>.
- Barber, DG, Hop, H, Mundy, CJ, Else, B, Dmitrenko, IA, Tremblay, J-E, Ehn, JK, Assmy, P, Daase, M, Candlish, LM, Rysgaard, S.** 2015. Selected physical, biological and biogeochemical implications of a rapidly changing Arctic Marginal Ice Zone. *Progress in Oceanography* **139**: 122–150. DOI: <http://dx.doi.org/10.1016/j.pocean.2015.09.003>.
- Behrenfeld, MJ.** 2010. Abandoning Sverdrup's Critical Depth Hypothesis on phytoplankton blooms. *Ecology* **91**(4): 977–989.
- Berge, J, Daase, M, Renaud, PE, Ambrose, WG Jr, Darnis, G, Last, KS, Leu, E, Cohen, JH, Johnsen, G, Moline, MA, Cottier, F, Varpe, Ø, Shunatova, N, Balazy, P, Morata, N, Massabuau, JC, Falk-Petersen, S, Kosobokova, K, Hoppe, CJM, Węślawski, JM, Kuklinski, P, Legeżyńska, J, Nikishina, D, Cusa, M, Kędra, M, Włodarska-Kowalczyk, M, Vogedes, D, Camus, L, Tran, D, Michaud, E, Gabrielsen, TM, Granovitch, A, Gonchar, A, Krapp, R, Callesen, TA.** 2015. Unexpected levels of biological activity during the polar night offer new perspectives on a warming Arctic. *Current Biology* **25**(19): 2555–2561. DOI: <http://dx.doi.org/10.1016/j.cub.2015.08.024>.
- Berry, D, Widder, S.** 2014. Deciphering microbial interactions and detecting keystone species with co-occurrence networks. *Frontiers in Microbiology* **5**: 219.
- Biard, T, Stemann, L, Picheral, M, Mayot, N, Vandromme, P, Hauss, H, Gorsky, G, Guidi, L, Kiko, R, Not, F.** 2016. In situ imaging reveals the biomass of giant protists in the global ocean. *Nature* **532**(7600): 504–507.
- Bluhm, BA, Gebruk, AV, Gradinger, R, Hopcroft, RR, Huettmann, F, Kosobokova, KN, Sirenko, BI, Weslawski, JM.** 2011. Arctic marine biodiversity: An update of species richness and examples of biodiversity change. *Oceanography* **24**(3): 232–248.
- Bluhm, BA, Hop, H, Vihtakari, M, Gradinger, R, Iken, K, Melnikov, IA, Søreide, JE.** 2018. Sea ice meiofauna distribution on local to pan-Arctic scales. *Ecology and Evolution* **8**(4): 2350–2364. DOI: <http://dx.doi.org/10.1002/ece3.3797>.
- Bluhm, BA, Kosobokova, KN, Carmack, EC.** 2015. A tale of two basins: An integrated physical and biological perspective of the deep Arctic Ocean. *Progress in Oceanography* **139**(C10): 89–121. DOI: <http://dx.doi.org/10.1016/j.pocean.2015.07.011>.
- Boetius, A, Anesio, AM, Deming, JW, Mikucki, JA, Rapp, JZ.** 2015. Microbial ecology of the cryosphere: Sea ice and glacial habitats. *Nature Reviews Microbiology* **13**(11): 677–690. DOI: <http://dx.doi.org/10.1038/nrmicro3522>.
- Bowman, JS.** 2021. Making sense of a scent-sensing metaphor for microbes and environmental predictions. *mSystems* **6**(4): e0099321.
- Bowman, JS, Amaral-Zettler, LA, Rich, JJ, Luria, CM, Ducklow, HW.** 2017. Bacterial community segmentation facilitates the prediction of ecosystem function along the coast of the western Antarctic Peninsula. *The ISME Journal* **11**(6): 1460–1471. DOI: <http://dx.doi.org/10.1038/ismej.2016.204>.
- Bowman, JS, Rasmussen, S, Blom, N, Deming, JW, Rysgaard, S, Sicheritz-Ponten, T.** 2012. Microbial community structure of Arctic multiyear sea ice and surface seawater by 454 sequencing of the 16S RNA gene. *The ISME Journal* **6**(1): 11–20. DOI: <http://dx.doi.org/10.1038/ismej.2011.76>.
- Cai, W-J, Chen, L, Chen, B, Gao, Z, Lee, SH, Chen, J, Pierrot, D, Sullivan, K, Wang, Y, Hu, X, Huang, W-J, Zhang, Y, Xu, S, Murata, A, Grebmeier, JM, Jones, EP, Zhang, H.** 2010. Decrease in the CO<sub>2</sub> uptake capacity in an ice-free Arctic Ocean basin. *Science* **329**(5991): 556–559. DOI: <http://dx.doi.org/10.1126/science.1189338>.
- Campbell, K, Lange, BA, Landy, JC, Katlein, C, Nicolaus, M, Anhaus, P, Matero, I, Gradinger, R, Charrette, J, Duerksen, S, Tremblay, P, Rysgaard, S, Tranter, M, Haas, C, Michel, C.** 2022. Net heterotrophy in high Arctic first-year and multi-year spring sea ice. *Elementa: Science of the Anthropocene* **10**(1): 00040. DOI: <http://dx.doi.org/10.1525/elementa.2021.00040>.
- Campbell, K, Mundy, CJ, Juhl, AR, Dalman, LA, Michel, C, Galley, RJ, Else, BE, Geilfus, NX, Rysgaard, S.** 2019. Melt procedure affects the photosynthetic response of sea ice algae. *Frontiers in Earth Science* **7**: 21. DOI: <http://dx.doi.org/10.3389/feart.2019.00021>.
- Campen, HI, Arévalo-Martínez, DL, Artioli, Y, Brown, IJ, Kitidis, V, Lessin, G, Rees, AP, Bange, HW.** 2022. The role of a changing Arctic Ocean and climate for the biogeochemical cycling of dimethyl sulphide and carbon monoxide. *Ambio* **51**(2): 411–422. DOI: <http://dx.doi.org/10.1007/s13280-021-01612-z>.
- Carlyle, CG, Roth, JD, Yurkowski, DJ, Kohlbach, D, Young, BG, Brown, TA, Riget, FF, Dietz, R, Ferguson, SH.** 2022. Spatial variation in carbon source use and trophic position of ringed seals across a latitudinal gradient of sea ice. *Ecological Indicators* **145**: 109746. DOI: <http://dx.doi.org/10.1016/j.ecolind.2022.109746>.
- Carmack, E, Wassmann, P.** 2006. Food webs and physical–biological coupling on pan-Arctic shelves: Unifying concepts and comprehensive perspectives. *Progress in Oceanography* **71**(2–4): 446–477. DOI: <http://dx.doi.org/10.1016/j.pocean.2006.10.004>.
- Chamberlain, EJ, Balmonte, JP, Torstensson, A, Fong, AA, Snoeijs-Leijonmalm, P, Bowman, JS.** 2022. Impacts of sea ice melting procedures on

- measurements of microbial community structure. *Elementa: Science of the Anthropocene* **10**(1): 00017. DOI: <http://dx.doi.org/10.1525/elementa.2022.00017>.
- Cleary, AC.** 2015. Distributions and interactions in three groups of polar marine plankton. University of Rhode Island. Available at [https://digitalcommons.uri.edu/oa\\_diss/329/](https://digitalcommons.uri.edu/oa_diss/329/). Accessed April 6, 2023.
- Clement Kinney, J, Frants, M, Maslowski, W, Osinski, R, Jeffery, N, Jin, M, Lee, YJ.** 2023. Investigation of under-ice phytoplankton growth in the fully-coupled, high-resolution regional Arctic system model. *Journal of Geophysical Research: Oceans* **128**(9): e2022JC019000. DOI: <http://dx.doi.org/10.1029/2022JC019000>.
- Clement Kinney, J, Maslowski, W, Osinski, R, Jin, M, Frants, M, Jeffery, N, Lee, YJ.** 2020. Hidden production: On the importance of pelagic phytoplankton blooms beneath Arctic Sea ice. *Journal of Geophysical Research: Oceans* **125**(9): e2020JC016211. DOI: <http://dx.doi.org/10.1029/2020JC016211>.
- Cornils, A, Thomisch, K, Hase, J, Hildebrandt, N, Auel, H, Niehoff, B.** 2022. Testing the usefulness of optical data for zooplankton long-term monitoring: Taxonomic composition, abundance, biomass, and size spectra from ZooScan image analysis. *Limnology and Oceanography: Methods* **20**(7): 428–450. DOI: <http://dx.doi.org/10.1002/lom3.10495>.
- Cox, C, Gallagher, M, Shupe, M, Persson, O, Grachev, A, Solomon, A, Ayers, T, Costa, D, Hutchings, J, Leach, J, Morris, S, Osborn, J, Pezoa, S, Uttal, T.** 2023a. Atmospheric surface flux station #30 measurements (Level 3 final), Multidisciplinary Drifting Observatory for the Study of Arctic Climate (MOSAIC), Central Arctic, October 2019–September 2020. NSF Arctic Data Center. DOI: <http://dx.doi.org/10.18739/A2FF3M18K>.
- Cox, CJ, Gallagher, MR, Shupe, MD, Persson, POG, Solomon, A, Fairall, CW, Ayers, T, Blomquist, B, Brooks, IM, Costa, D, Grachev, A, Gottas, D, Hutchings, JK, Kutchenreiter, M, Leach, J, Morris, SM, Morris, V, Osborn, J, Pezoa, S, Preußer, A, Riihimaki, LD, Uttal, T.** 2023b. Continuous observations of the surface energy budget and meteorology over the Arctic sea ice during MOSAIC. *Scientific Data* **10**(1): 519. DOI: <http://dx.doi.org/10.1038/s41597-023-02415-5>.
- Creamean, JM, Barry, K, Hill, TCJ, Hume, C, DeMott, PJ, Shupe, MD, Dahlke, S, Willmes, S, Schmale, J, Beck, I, Hoppe, CJM, Fong, A, Chamberlain, E, Bowman, J, Scharien, R, Persson, O.** 2022. Annual cycle observations of aerosols capable of ice formation in central Arctic clouds. *Nature Communications* **13**(1): 3537. DOI: <http://dx.doi.org/10.1038/s41467-022-31182-x>.
- Deming, JW, Collins, ER.** 2017. Sea ice as a habitat for bacteria, archaea and viruses, in Thomas, DN ed., *Sea ice*. Hoboken, NJ: Wiley: 326–351. DOI: <http://dx.doi.org/10.1002/9781118778371.ch13>.
- DiMucci, D, Kon, M, Segrè, D.** 2018. Machine learning reveals missing edges and putative interaction mechanisms in microbial ecosystem networks. *mSystems* **3**(5): e00181–e00218.
- Dutta, A, Goldman, T, Keating, J, Burke, E, Williamson, N, Dirmeier, R, Bowman, JS.** 2022. Machine learning predicts biogeochemistry from microbial community structure in a complex model system. *Microbiology Spectrum* **10**(1): e0190921.
- Ehrlich, J, Schaafsma, FL, Bluhm, BA, Peeken, I, Castellani, G, Brandt, A, Flores, H.** 2020. Sympagic fauna in and under Arctic pack ice in the annual sea-ice system of the new Arctic. *Frontiers in Marine Science* **7**: 452. DOI: <http://dx.doi.org/10.3389/fmars.2020.00452>.
- Else, BGT, Papakyriakou, TN, Asplin, MG, Barber, DG, Galley, RJ, Miller, LA, Mucci, A.** 2013. Annual cycle of air-sea CO<sub>2</sub> exchange in an Arctic polynya region. *Global Biogeochemical Cycles* **27**(2): 388–398. DOI: <http://dx.doi.org/10.1002/gbc.20016>.
- Ershova, EA, Kosobokova, KN, Banas, NS, Ellingsen, I, Niehoff, B, Hildebrandt, N, Hirche, H-J.** 2021. Sea ice decline drives biogeographical shifts of key *Calanus* species in the central Arctic Ocean. *Global Change Biology* **27**(10): 2128–2143. DOI: <http://dx.doi.org/10.1111/gcb.15562>.
- Falkowski, P, Scholes, RJ, Boyle, E, Canadell, J, Canfield, D, Elser, J, Gruber, N, Hibbard, K, Högberg, P, Linder, S, Mackenzie, FT, Moore, B III, Pedersen, T, Rosenthal, Y, Seitzinger, S, Smetacek, V, Steffen, W.** 2000. The Global carbon cycle: A test of our knowledge of earth as a system. *Science* **290**(5490): 291–296. DOI: <http://dx.doi.org/10.1126/science.290.5490.291>.
- Falkowski, PG, Barber, RT, Smetacek, V.** 1998. Biogeochemical controls and feedbacks on ocean primary production. *Science* **281**(5374): 200–206. DOI: <http://dx.doi.org/10.1126/science.281.5374.200>.
- Faust, K, Raes, J.** 2012. Microbial interactions: From networks to models. *Nature Reviews Microbiology* **10**(8): 538–550.
- Fernández-Méndez, M, Olsen, LM, Kauko, HM, Meyer, A, Rösel, A, Merkouriadi, I, Mundy, CJ, Ehn, JK, Johansson, AM, Wagner, PM, Ervik, Å, Sorrell, BK, Duarte, P, Wold, A, Hop, H, Assmy, P.** 2018. Algal hot spots in a changing Arctic Ocean: Sea-ice ridges and the snow-ice interface. *Frontiers in Marine Science* **5**. DOI: <http://dx.doi.org/10.3389/fmars.2018.00075>.
- Fortier, L, Cochran, JK.** 2008. Introduction to special section on annual cycles on the Arctic Ocean shelf. *Journal of Geophysical Research: Oceans* **113**(C3). DOI: <http://dx.doi.org/10.1029/2007JC004457>.
- Fouilland, E, Gosselin, M, Rivkin, RB, Vasseur, C, Mostajir, B.** 2007. Nitrogen uptake by heterotrophic bacteria and phytoplankton in Arctic surface waters. *Journal of Plankton Research* **29**(4): 369–376. DOI: <http://dx.doi.org/10.1093/plankt/fbm022>.
- Fransson, A, Chierici, M, Miller, LA, Carnat, G, Shadwick, E, Thomas, H, Pineault, S, Papakyriakou,**

- TN.** 2013. Impact of sea-ice processes on the carbonate system and ocean acidification at the ice-water interface of the Amundsen Gulf, Arctic Ocean. *Journal of Geophysical Research: Oceans* **118**(12): 7001–7023. DOI: <http://dx.doi.org/10.1002/2013JC009164>.
- Fransson, A, Chierici, M, Skjelvan, I, Olsen, A, Assmy, P, Peterson, AK, Spreen, G, Ward, B.** 2017. Effects of sea-ice and biogeochemical processes and storms on under-ice water fCO<sub>2</sub> during the winter-spring transition in the high Arctic Ocean: Implications for sea-air CO<sub>2</sub> fluxes. *Journal of Geophysical Research: Oceans* **122**(7): 5566–5587.
- Fransson, A, Chierici, M, Yager, PL, Smith, WO Jr.** 2011. Antarctic sea ice carbon dioxide system and controls. *Journal of Geophysical Research: Oceans* **116**(C12). DOI: <http://dx.doi.org/10.1029/2010JC006844>.
- Garrison, DL, Buck, KR.** 1986. Organism losses during ice melting: A serious bias in sea ice community studies. *Polar Biology* **6**(4): 237–239. DOI: <http://dx.doi.org/10.1007/BF00443401>.
- Giering, SLC, Culverhouse, PF, Johns, DG, McQuatters-Gollop, A, Pitois, SG.** 2022. Are plankton nets a thing of the past? An assessment of in situ imaging of zooplankton for large-scale ecosystem assessment and policy decision-making. *Frontiers in Marine Science* **9**: 986206.
- Goldford, JE, Lu, N, Bajić, D, Estrela, S, Tikhonov, M, Sanchez-Gorostiaga, A, Segrè, D, Mehta, P, Sanchez, A.** 2018. Emergent simplicity in microbial community assembly. *Science* **361**(6401): 469–474.
- Gonçalves-Araujo, R, Granskog, MA, Bracher, A, Azetsu-Scott, K, Dodd, PA, Stedmon, CA.** 2016. Using fluorescent dissolved organic matter to trace and distinguish the origin of Arctic surface waters. *Scientific Reports* **6**(1): 33978.
- Gorsky, G, Ohman, MD, Picheral, M, Gasparini, S, Stemmann, L, Romagnan, J-B, Cawood, A, Pesant, S, García-Comas, C, Prejger, F.** 2010. Digital zooplankton image analysis using the ZooScan integrated system. *Journal of Plankton Research* **32**(3): 285–303. DOI: <http://dx.doi.org/10.1093/plankt/fbp124>.
- Gosselin, M, Lavoie, M, Wheeler, PA, Horner, RA, Booth, BC.** 1997. New measurements of phytoplankton and ice algal production in the Arctic Ocean. *Deep Sea Research Part II: Topical Studies in Oceanography* **44**(8): 1623–1644. DOI: [http://dx.doi.org/10.1016/S0967-0645\(97\)00054-4](http://dx.doi.org/10.1016/S0967-0645(97)00054-4).
- Gowing, MM, Garrison, DL, Gibson, AH, Krupp, JM, Jeffries, MO, Fritsen, CH.** 2004. Bacterial and viral abundance in Ross Sea summer pack ice communities. *Marine Ecology Progress Series* **279**: 3–12.
- Gradinger, R.** 1996. Occurrence of an algal bloom under Arctic pack ice. *Marine Ecology Progress Series* **131**: 301–305.
- Gradinger, R, Bluhm, B, Iken, K.** 2010. Arctic sea-ice ridges—Safe heavens for sea-ice fauna during periods of extreme ice melt? *Deep Sea Research Part II: Topical Studies in Oceanography* **57**(1–2): 86–95. DOI: <http://dx.doi.org/10.1016/j.dsr2.2009.08.008>.
- Granskog, MA, Fer, I, Rinke, A, Steen, H.** 2018. Atmosphere-ice-ocean-ecosystem processes in a thinner Arctic sea ice regime: The Norwegian young sea ICE (N-ICE2015) expedition. *Journal of Geophysical Research: Oceans* **123**(3): 1586–1594. DOI: <http://dx.doi.org/10.1002/2017JC013328>.
- Gregory, AC, Zayed, AA, Conceição-Neto, N, Temperton, B, Bolduc, B, Alberti, A, Ardyna, M, Arkhipova, K, Carmichael, M, Cruaud, C, Dimier, C, Domínguez-Huerta, G, Ferland, J, Kandels, S, Liu, Y, Marec, C, Pesant, S, Picheral, M, Pisarev, S, Poulain, J, Tremblay, J-É, Vik, D; Tara Oceans Coordinators; Babin, M, Bowler, C, Culley, AI, de Vargas, C, Dutilh, BE, Iudicone, D, Karp-Boss, L, Roux, S, Sunagawa, S, Wincker, P, Sullivan, MB.** 2019. Marine DNA viral macro- and microdiversity from pole to pole. *Cell* **177**(5): 1109–1123. DOI: <http://dx.doi.org/10.1016/j.cell.2019.03.040>.
- Haas, C.** 2020. Links to master tracks in different resolutions of POLARSTERN cruise PS122/2, Arctic Ocean—Arctic Ocean, 2019-12-13–2020-02-24 (Version 2) [dataset]. Alfred Wegener Institute, Helmholtz Center for Polar and Marine Research, Bremerhaven, PANGAEA. DOI: <http://dx.doi.org/10.1594/PANGAEA.924674>.
- Hamilton, BM, Jantunen, L, Bergmann, M, Vorkamp, K, Aherne, J, Magnusson, K, Herzke, D, Granberg, M, Hallanger, IG, Gomiero, A, Peeken, I.** 2022. Microplastics in the atmosphere and cryosphere in the circumpolar North: A case for multicompartment monitoring. *Arctic Science* **8**(4): 1116–1126.
- Hobbs, L, Banas, NS, Cottier, FR, Berge, J, Daase, M.** 2020. Eat or sleep: Availability of winter prey explains mid-winter and spring activity in an Arctic *Calanus* population. *Frontiers in Marine Science* **7**: 541564. DOI: <http://dx.doi.org/10.3389/fmars.2020.541564>.
- Hop, H, Vihtakari, M, Bluhm, BA, Assmy, P, Poulin, M, Gradinger, R, Peeken, I, von Quillfeldt, C, Olsen, LM, Zhitina, L, Melnikov, IA.** 2020. Changes in sea-ice protist diversity with declining sea ice in the Arctic Ocean from the 1980s to 2010s. *Frontiers in Marine Science* **7**: 243. DOI: <http://dx.doi.org/10.3389/fmars.2020.00243>.
- Hop, H, Vihtakari, M, Bluhm, BA, Daase, M, Gradinger, R, Melnikov, IA.** 2021. Ice-associated amphipods in a pan-Arctic scenario of declining sea ice. *Frontiers in Marine Science* **8**. DOI: <http://dx.doi.org/10.3389/fmars.2021.743152>.
- Hoppe, CJM.** 2022. Always ready? Primary production of Arctic phytoplankton at the end of the polar night. *Limnology and Oceanography Letters* **7**(2): 167–174. DOI: <http://dx.doi.org/10.1002/lol2.10222>.
- Ibarbalz, FM, Henry, N, Mahé, F, Ardyna, M, Zingone, A, Scalco, E, Lovejoy, C, Lombard, F, Jaillon, O, Iudicone, D, Malviya, S; Tara Oceans Coordinators; Sullivan, MB, Chaffron, S, Karsenti, E, Babin, M, Boss, E, Wincker, P, Zinger, L, de Vargas, C, Bowler, C, Karp-Boss, L.** 2023. Pan-Arctic

- plankton community structure and its global connectivity. *Elementa: Science of the Anthropocene* **11**(1): 00060. DOI: <http://dx.doi.org/10.1525/elementa.2022.00060>.
- Ingvaldsen, RB, Assmann, KM, Primicerio, R, Fosheim, M, Polyakov, IV, Dolgov, AV.** 2021. Physical manifestations and ecological implications of Arctic Atlantification. *Nature Reviews Earth & Environment* **2**(12): 874–889.
- Intergovernmental Panel on Climate Change.** 2023. Climate change 2021—The physical science basis: Working Group I contribution to the Sixth Assessment Report of the Intergovernmental Panel on Climate Change. Cambridge, UK: Cambridge University Press: i–ii. Available at <https://www.cambridge.org/core/books/climate-change-2021-the-physical-science-basis/frontmatter/84D59430721AC15204CEAFA4F3902A42>. Accessed March 2, 2023.
- Johnsen, G, Leu, E, Gradinger, R.** 2020. Marine micro- and macroalgae in the polar night, in Berge, J, Johnsen, G, Cohen, JH eds., *Polar night marine ecology: Life and light in the dead of night*. Cham, Switzerland: Springer International Publishing: 67–112. DOI: [http://dx.doi.org/10.1007/978-3-030-33208-2\\_4](http://dx.doi.org/10.1007/978-3-030-33208-2_4).
- Jones, EP, Anderson, LG, Jutterström, S, Mintrop, L, Swift, JH.** 2008. Pacific freshwater, river water and sea ice meltwater across Arctic Ocean basins: Results from the 2005 Beringia expedition. *Journal of Geophysical Research: Oceans* **113**(C8). DOI: <http://dx.doi.org/10.1029/2007JC004124>.
- Kaiser, P, Hagen, W, Bode-Dalby, M, Auel, H.** 2022. Tolerant but facing increased competition: Arctic zooplankton versus Atlantic invaders in a warming ocean. *Frontiers in Marine Science* **9**: 908638. DOI: <http://dx.doi.org/10.3389/fmars.2022.908638>.
- Kanzow, T.** 2020. Links to master tracks in different resolutions of POLARSTERN cruise PS122/3, Arctic Ocean—Longyearbyen, 2020-02-24–2020-06-04 (Version 2) [dataset]. Alfred Wegener institute, Helmholtz Centre for polar and marine research, Bremerhaven, PANGAEA. DOI: <http://dx.doi.org/10.1594/PANGAEA.924681>.
- Katlein, C, Schiller, M, Belter, HJ, Coppolaro, V, Wenslandt, D, Nicolaus, M.** 2017. A new remotely operated sensor platform for interdisciplinary observations under sea ice. *Frontiers in Marine Science* **4**. DOI: <http://dx.doi.org/10.3389/fmars.2017.00281>.
- Kauko, HM, Taskjelle, T, Assmy, P, Pavlov, AK, Mundy, CJ, Duarte, P, Fernández-Méndez, M, Olsen, LM, Hudson, SR, Johnsen, G, Elliott, A, Wang, F, Granskog, MA.** 2017. Windows in Arctic Sea ice: Light transmission and ice algae in a refrozen lead. *Journal of Geophysical Research: Biogeosciences* **122**(6): 1486–1505. DOI: <http://dx.doi.org/10.1002/2016JG003626>.
- Kiko, R, Biastoch, A, Brandt, P, Cravatte, S, Hauss, H, Hummels, R, Kriest, I, Marin, F, McDonnell, AMP, Oschlies, A, Picherl, M, Schwarzkopf, FU, Thurnherr, AM, Stemmann, L.** 2017. Biological and physical influences on marine snowfall at the equator. *Nature Geoscience* **10**(11): 852–858.
- Kim, HH, Bowman, JS, Luo, Y-W, Ducklow, HW, Schofield, OM, Steinberg, DK, Doney, SC.** 2022. Modeling polar marine ecosystem functions guided by bacterial physiological and taxonomic traits. *Biogeosciences* **19**(1): 117–136. DOI: <http://dx.doi.org/10.5194/bg-19-117-2022>.
- Kohlbach, D, Graeve, M, Lange, AB, David, C, Peeken, I, Flores, H.** 2016. The importance of ice algae-produced carbon in the central Arctic Ocean ecosystem: Food web relationships revealed by lipid and stable isotope analyses. *Limnology and Oceanography* **61**(6): 2027–2044. DOI: <http://dx.doi.org/10.1002/lno.10351>.
- Kohlbach, D, Smik, L, Belt, ST, Hop, H, Wold, A, Graeve, M, Assmy, P.** 2022. A multi-trophic marker approach reveals high feeding plasticity in Barents Sea under-ice fauna. *Progress in Oceanography* **208**(7): 102895.
- Kong, X, Granskog, MA, Hoppe, CJM, Fong, AA, Stedmon, CA, Tippenhauer, S, Ulfsbo, A, Vredenburg, M, Koch, BP.** 2024. Variability of dissolved organic matter sources in the upper Eurasian Arctic Ocean. *Journal of Geophysical Research: Oceans* **129**: e2023JC020844. DOI: <https://doi.org/10.1029/2023JC020844>.
- Kosobokova, K, Hirche, H-J.** 2000. Zooplankton distribution across the Lomonosov ridge, Arctic Ocean: Species inventory, biomass and vertical structure. *Deep Sea Research Part I: Oceanographic Research Papers* **47**(11): 2029–2060.
- Kosobokova, KN, Hopcroft, RR, Hirche, H-J.** 2011. Patterns of zooplankton diversity through the depths of the Arctic's central basins. *Marine Biodiversity* **41**(1): 29–50. DOI: <http://dx.doi.org/10.1007/s12526-010-0057-9>.
- Krembs, C, Eicken, H, Deming, JW.** 2011. Exopolymer alteration of physical properties of sea ice and implications for ice habitability and biogeochemistry in a warmer Arctic. *Proceedings of the National Academy of Sciences* **108**(9): 3653–3658.
- Krumpen, T, Birrien, F, Kauker, F, Rackow, T, von Albedyll, L, Angelopoulos, M, Belter, HJ, Bessonov, V, Damm, E, Dethloff, K, Haapala, J, Haas, C, Harris, C, Hendricks, S, Hoelemann, J, Hoppmann, M, Kaleschke, L, Karcher, M, Kolabutin, N, Lei, R, Lenz, J, Morgenstern, A, Nicolaus, M, Nixdorf, U, Petrovsky, T, Rabe, B, Rabenstein, L, Rex, M, Ricker, R, Rohde, J, Shimanuchuk, E, Singha, S, Smolyanitsky, V, Sokolov, V, Stanton, T, Timofeeva, A, Tsamados, M, Watkins, D.** 2020. The MOSAiC ice floe: Sediment-laden survivor from the Siberian shelf. *The Cryosphere* **14**(7): 2173–2187. DOI: <http://dx.doi.org/10.5194/tc-14-2173-2020>.
- Kunisch, EH, Graeve, M, Gradinger, R, Haug, T, Kovacs, KM, Lydersen, C, Varpe, Ø, Bluhm, BA.** 2021. Ice-algal carbon supports harp and ringed seal diets in the European Arctic: Evidence from fatty acid and



- stable isotope markers. *Marine Ecology Progress Series* **675**: 181–197.
- Kvernvik, AC, Hoppe, CJM, Lawrenz, E, Prášil, O, Greenacre, M, Wiktor, JM, Leu, E.** 2018. Fast reactivation of photosynthesis in Arctic phytoplankton during the polar night. *Journal of Phycology* **54**(4): 461–470. DOI: <http://dx.doi.org/10.1111/jpy.12750>.
- Kvile, KØ, Ashjian, C, Ji, R.** 2019. Pan-Arctic depth distribution of diapausing *Calanus* copepods. *The Biological Bulletin* **237**(2): 76–89. DOI: <http://dx.doi.org/10.1086/704694>.
- Lannuzel, D, Tedesco, L, van Leeuwe, M, Campbell, K, Flores, H, Delille, B, Miller, L, Stefels, J, Assmy, P, Bowman, J, Brown, K, Castellani, G, Chierici, M, Crabeck, O, Damm, E, Else, B, Fransson, A, Fripiat, F, Geilfus, N-X, Jacques, C, Jones, E, Kaarto-kallio, H, Kotovitch, M, Meiners, K, Moreau, S, Nomura, D, Peeken, I, Rintala, J-M, Steiner, N, Tison, J-L, Vancoppenolle, M, Van der Linden, F, Vichi, M, Wongpan, P.** 2020. The future of Arctic Sea-ice biogeochemistry and ice-associated ecosystems. *Nature Climate Change* **10**(11): 983–992. DOI: <http://dx.doi.org/10.1038/s41558-020-00940-4>.
- Laurion, I, Demers, S, Vezina, AF.** 1995. The microbial food web associated with the ice algal assemblage: Biomass and bacterivory of nanoflagellate protozoans in Resolute Passage (High Canadian Arctic). *Marine Ecology Progress Series* **120**(1–3): 77–87.
- Leu, E, Brown, TA, Graeve, M, Wiktor, J, Hoppe, CJM, Chierici, M, Fransson, A, Verbiest, S, Kvernvik, AC, Greenacre, MJ.** 2020. Spatial and temporal variability of ice algal trophic markers—With recommendations about their application. *Journal of Marine Science and Engineering* **8**(9). DOI: <http://dx.doi.org/10.3390/jmse8090676>.
- Leu, E, Mundy, CJ, Assmy, P, Campbell, K, Gabrielsen, TM, Gosselin, M, Juul-Pedersen, T, Gradinger, R.** 2015. Arctic spring awakening—Steering principles behind the phenology of vernal ice algal blooms. *Progress in Oceanography* **139**: 151–170. DOI: <http://dx.doi.org/10.1016/j.pocean.2015.07.012>.
- Lombard, F, Boss, E, Waite, AM, Vogt, M, Uitz, J, Stemmann, L, Sosik, HM, Schulz, J, Romagnan, J-B, Picheral, M, Pearlman, JS, Ohman, MD, Niehoff, B, Möller, KO, Miloslavich, P, Lara-Lopez, A, Kudela, R, Lopes, RM, Kiko, R, Karp-Boss, L, Jaffe, JS, Iversen, MH, Irisson, J-O, Fennel, K, Hauss, H, Guidi, L, Gorsky, G, Giering, SLC, Gaube, P, Gallagher, S, Dubelaar, G, Cowen, RK, Carlotti, F, Briseño-Avena, C, Berline, L, Benoit-Bird, K, Bax, N, Batten, S, Ayata, S-D, Artigas, LF, Appeltans, W.** 2019. Globally consistent quantitative observations of planktonic ecosystems. *Frontiers in Marine Science* **6**: 196.
- Lotka, AJ.** 1920. Analytical note on certain rhythmic relations in organic systems. *Proceedings of the National Academy of Sciences* **6**(7): 410–415.
- Ludvigsen, M, Berge, J, Geoffroy, M, Cohen, JH, De La Torre, PR, Nornes, SM, Singh, H, Sørensen, AJ, Daase, M, Johnsen, G.** 2018. Use of an autonomous surface vehicle reveals small-scale diel vertical migrations of zooplankton and susceptibility to light pollution under low solar irradiance. *Science Advances* **4**(1): eaap9887.
- Lund-Hansen, LC, Hawes, I, Hancke, K, Salmansen, N, Nielsen, JR, Balslev, L, Sorrell, BK.** 2020. Effects of increased irradiance on biomass, photobiology, nutritional quality, and pigment composition of Arctic Sea ice algae. *Marine Ecology Progress Series* **648**: 95–110.
- MacArthur, R.** 1970. Species packing and competitive equilibrium for many species. *Theoretical Population Biology* **1**(1): 1–11.
- Malinauskaite, L, Cook, D, Davíðsdóttir, B, Ögmundar-dóttir, H, Roman, J.** 2019. Ecosystem services in the Arctic: A thematic review. *Ecosystem Services* **36**: 100898.
- Manizza, M, Follows, MJ, Dutkiewicz, S, Menemenlis, D, Hill, CN, Key, RM.** 2013. Changes in the Arctic Ocean CO<sub>2</sub> sink (1996–2007): A regional model analysis. *Global Biogeochemical Cycles* **27**(4): 1108–1118. DOI: <http://dx.doi.org/10.1002/2012gb004491>.
- Maranger, R, Bird, DF, Juniper, SK.** 1994. Viral and bacterial dynamics in Arctic Sea ice during the spring algal bloom near Resolute, N.W.T., Canada. *Marine Ecology Progress Series* **111**(1–2): 121–127.
- Marangoni, LFB, Davies, T, Smyth, T, Rodríguez, A, Hamann, M, Duarte, C, Pendoley, K, Berge, J, Maggi, E, Levy, O.** 2022. Impacts of artificial light at night in marine ecosystems—A review. *Global Change Biology* **28**(18): 5346–5367.
- Melnikov, IA.** 1980. The ecosystem of Arctic pack ice, in Vinogradov, ME, Melnikov, IA eds., *Biology of the Central Arctic Basin*. Moscow, Russia: Shirshov Institute of Oceanology, Academy of Sciences of the USSR, Nauka (Science) Press: 61–96.
- Metfies, K, Schroeder, F, Hessel, J, Wollschläger, J, Micheller, S, Wolf, C, Kiliyas, E, Sprong, P, Neuhäus, S, Frickenhaus, S, Petersen, W.** 2016. High-resolution monitoring of marine protists based on an observation strategy integrating automated on-board filtration and molecular analyses. *Ocean Science* **12**(6): 1237–1247. DOI: <http://dx.doi.org/10.5194/os-12-1237-2016>.
- Miller, LA, Carnat, G, Else, BGT, Sutherland, N, Papakyriakou, TN.** 2011. Carbonate system evolution at the Arctic Ocean surface during autumn freeze-up. *Journal of Geophysical Research: Oceans* **116**(C9). DOI: <https://doi.org/10.1029/2011JC007143>.
- Mo, A, Kim, D, Yang, EJ, Jung, J, Ko, YH, Kang, S-H, Cho, K-H, Park, K, Kim, T-W.** 2022. Factors affecting the subsurface aragonite undersaturation layer in the Pacific Arctic region. *Marine Pollution Bulletin* **183**(C10): 114060.
- Mock, T, Boulton, W, Balmonte, J-P, Barry, K, Bertilsson, S, Bowman, J, Buck, M, Bratbak, G, Chamberlain, EJ, Cunliffe, M, Creamean, J, Ebenhöf, O, Eggers, SL, Fong, AA, Gardner, J, Gradinger, R, Granskog, MA, Havermans, C, Hills, T, Hoppe,**

- CJM, Korte, K, Larsen, A, Müller, O, Nicolaus, A, Oldenburg, E, Popa, O, Rogge, S, Schäfers, H, Shoemaker, K, Snoeijs-Leijonmalm, P, Torstensson, A, Vlentini, K, Vader, A, Barry, K, Chen, I-MA, Clum, A, Copeland, A, Daum, C, Eloë-Fadrosh, E, Foster, B, Foster, B, Grigoriev, IV, Huntemann, M, Ivanova, N, Kuo, A, Kyrpides, NC, Mukherjee, S, Palaniappan, K, Reddy, TBK, Salamov, A, Roux, S, Varghese, N, Woyke, T, Wu, D, Leggett, RM, Moulton, V, Metfies, K. 2022. Multiomics in the central Arctic Ocean for benchmarking biodiversity change. *PLOS Biology* **20**(10): e3001835. DOI: <http://dx.doi.org/10.1371/journal.pbio.3001835>.
- Mundy, CJ, Gosselin, M, Ehn, JK, Belzile, C, Poulin, M, Alou, E, Roy, S, Hop, H, Lessard, S, Papakyriakou, TN, Barber, DG, Stewart, J. 2011. Characteristics of two distinct high-light acclimated algal communities during advanced stages of sea ice melt. *Polar Biology* **34**(12): 1869–1886. DOI: <http://dx.doi.org/10.1007/s00300-011-0998-x>.
- Nicolaus, M, Anhaus, P, Hoppmann, M, Tao, R, Katlein, C. 2023a. Spectral radiation fluxes, albedo and transmittance from autonomous measurement from Radiation Station 2020R12, deployed during MOSAiC 2019/20. PANGAEA. DOI: <http://dx.doi.org/10.1594/PANGAEA.948712>.
- Nicolaus, M, Belter, HJ, Rohde, J, Hoppmann, M, Tao, R, Katlein, C. 2023b. Spectral radiation fluxes, albedo and transmittance from autonomous measurement from Radiation Station 2019R8, deployed during MOSAiC 2019/20. PANGAEA. DOI: <http://dx.doi.org/10.1594/PANGAEA.948876>.
- Nicolaus, M, Hoppmann, M, Tao, R, Katlein, C. 2022a. Spectral radiation fluxes, albedo and transmittance from autonomous measurement from Radiation Station 2020R22, deployed during MOSAiC 2019/20. PANGAEA. DOI: <http://dx.doi.org/10.1594/PANGAEA.942602>.
- Nicolaus, M, Perovich, DK, Spreen, G, Granskog, MA, von Albedyll, L, Angelopoulos, M, Anhaus, P, Arndt, S, Belter, HJ, Bessonov, V, Birnbaum, G, Brauchle, J, Calmer, R, Cardellach, E, Cheng, B, Clemens-Sewall, D, Dadic, R, Damm, E, de Boer, G, Demir, O, Dethloff, K, Divine, DV, Fong, AA, Fons, S, Frey, MM, Fuchs, N, Gabarró, C, Gerland, S, Goessling, HF, Gradinger, R, Haapala, J, Haas, C, Hamilton, J, Hannula, H-R, Hendricks, S, Herber, A, Heuzé, C, Hoppmann, M, Høyland, KV, Huntemann, M, Hutchings, JK, Hwang, B, Itkin, P, Jacobi, H-W, Jaggi, M, Jutila, A, Kaleschke, L, Katlein, C, Kolabutin, N, Krampe, D, Kristensen, SS, Krumpfen, T, Kurtz, N, Lampert, A, Lange, BA, Lei, R, Light, B, Linhardt, F, Liston, GE, Loose, B, Macfarlane, AR, Mahmud, M, Matero, IO, Maus, S, Morgenstern, A, Naderpour, R, Nandan, V, Niubom, A, Oggier, M, Oppelt, N, Pätzold, F, Perron, C, Petrovsky, T, Pirazzini, R, Polashenski, C, Rabe, B, Raphael, IA, Regnery, J, Rex, M, Ricker, R, Riemann-Campe, K, Rinke, A, Rohde, J, Salganik, E, Scharien, RK, Schiller, M, Schneebeli, M, Semmling, M, Shimanchuk, E, Shupe, MD, Smith, MM, Smolyanitsky, V, Sokolov, V, Stanton, T, Stroeve, J, Thielke, L, Timofeeva, A, Tonboe, RT, Tavri, A, Tsamados, M, Wagner, DN, Watkins, D, Webster, M, Wendisch, M. 2022b. Overview of the MOSAiC expedition: Snow and sea ice. *Elementa: Science of the Anthropocene* **10**(1): 000046. DOI: <http://dx.doi.org/10.1525/elementa.2021.000046>.
- Nixdorf, U, Dethloff, K, Rex, M, Shupe, M, Sommerfeld, A, Perovich, DK, Nicolaus, M, Heuzé, C, Rabe, B, Loose, B, Damm, E, Gradinger, R, Fong, A, Maslowski, W, Rinke, A, Kwok, R, Spreen, G, Wendisch, M, Herber, A, Hirsekorn, M, Mohaupt, V, Frickenhaus, S, Immerz, A, Weiss-Tuider, K, König, B, Menedoht, D, Regnery, J, Gerchow, P, Ransby, D, Krumpfen, T, Morgenstern, A, Haas, C, Kanzow, T, Rack, FR, Saitzev, V, Sokolov, V, Makarov, A, Schwarze, S, Wunderlich, T, Wurr, K, Boetius, A. 2021. MOSAiC extended acknowledgement. Zenodo. DOI: <https://doi.org/10.5281/zenodo.5541624>.
- Nomura, D, Granskog, MA, Fransson, A, Chierici, M, Silyakova, A, Ohshima, KI, Cohen, L, Delille, B, Hudson, SR, Dieckmann, GS. 2018. CO<sub>2</sub> flux over young and snow-covered Arctic pack ice in winter and spring. *Biogeosciences* **15**(11): 3331–3343.
- Nomura, D, Wongpan, P, Toyota, T, Tanikawa, T, Kawaguchi, Y, Ono, T, Ishino, T, Tozawa, M, Tamura, TP, Yabe, IS, Son, EY, Vivier, F, Lourenço, A, Lebrun, M, Nosaka, Y, Hirawake, T, Ooki, A, Aoki, S, Else, B, Fripiat, F, Inoue, J, Vancoppenolle, M. 2020. Saroma-ko Lagoon Observations for sea ice Physico-chemistry and Ecosystems 2019 (SLOPE2019). *Bulletin of Glaciological Research* **38**: 1–12.
- Olsen, LM, Laney, SR, Duarte, P, Kauko, HM, Fernández-Méndez, M, Mundy, CJ, Rösel, A, Meyer, A, Itkin, P, Cohen, L, Peeken, I, Tatarek, A, Róžańska-Pluta, M, Wiktor, J, Taskjelle, T, Pavlov, AK, Hudson, SR, Granskog, MA, Hop, H, Assmy, P. 2017. The seeding of ice algal blooms in Arctic pack ice: The multiyear ice seed repository hypothesis. *Journal of Geophysical Research: Biogeosciences* **122**(7): 1529–1548. DOI: <http://dx.doi.org/10.1002/2016JG003668>.
- Patrohay, E, Gradinger, R, Marquardt, M, Bluhm, BA. 2022. First trait-based characterization of Arctic ice meiofauna taxa. *Polar Biology* **45**(12): 1673–1688. DOI: <http://dx.doi.org/10.1007/s00300-022-03099-0>.
- Picheral, M, Colin, S, Irisson, J-O. 2017. EcoTaxa, a tool for the taxonomic classification of images. Available at <http://ecotaxa.obs-vlfr.fr/>. Accessed January 2, 2023.
- Polyakov, IV, Alkire, MB, Bluhm, BA, Brown, KA, Carmack, EC, Chierici, M, Danielson, SL, Ellingsen, I, Ershova, EA, Gårdfeldt, K, Ingvaldsen, RB, Pnyushkov, AV, Slagstad, D, Wassmann, P. 2020. Borealization of the Arctic Ocean in response to anomalous advection from sub-Arctic seas. *Frontiers in Marine Science* **7**. DOI: <http://dx.doi.org/10.3389/fmars.2020.00491>.

- Popa, O, Oldenburg, E, Ebenhöh, O.** 2020. From sequence to information. *Philosophical Transactions of the Royal Society B* **375**(1814): 20190448.
- Popova, EE, Yool, A, Coward, AC, Dupont, F, Deal, C, Elliott, S, Hunke, E, Jin, M, Steele, M, Zhang, J.** 2012. What controls primary production in the Arctic Ocean? Results from an intercomparison of five general circulation models with biogeochemistry. *Journal of Geophysical Research: Oceans* **117**(C8): C00D12. DOI: <http://dx.doi.org/10.1029/2011jc007112>.
- Poulin, M, Daugbjerg, N, Gradinger, R, Ilyash, L, Ratkova, T, von Quillfeldt, C.** 2011. The pan-Arctic biodiversity of marine pelagic and sea-ice unicellular eukaryotes: A first-attempt assessment. *Marine Biodiversity* **41**(1): 13–28. DOI: <http://dx.doi.org/10.1007/s12526-010-0058-8>.
- Qi, D, Ouyang, Z, Chen, L, Wu, Y, Lei, R, Chen, B, Feely, RA, Anderson, LG, Zhong, W, Lin, H, Polukhin, A, Zhang, Y, Zhang, Y, Bi, H, Lin, X, Luo, Y, Zhuang, Y, He, J, Chen, J, Cai, W-J.** 2022. Climate change drives rapid decadal acidification in the Arctic Ocean from 1994 to 2020. *Science* **377**(6614): 1544–1550. DOI: <http://dx.doi.org/10.1126/science.abo0383>.
- Rabe, B, Cox, CJ, Fang, Y-C, Goessling, H, Granskog, MA, Hoppmann, M, Hutchings, JK, Krumpfen, T, Kuznetsov, I, Lei, R, Li, T, Maslowski, W, Nicolaus, M, Perovich, D, Persson, O, Regnery, J, Rigor, I, Shupe, MD, Sokolov, V, Spreen, G, Stanton, T, Watkins, DM, Blockley, E, Buenger, HJ, Cole, S, Fong, A, Haapala, J, Heuzé, C, Hoppe, CJM, Janout, M, Jutila, A, Katlein, C, Krishfield, R, Lin, L, Ludwig, V, Morgenstern, A, O'Brien, J, Zurita, AQ, Rackow, T, Riemann-Campe, K, Rohde, J, Shaw, W, Smolyanitsky, V, Solomon, A, Sperling, A, Tao, R, Toole, J, Tsamados, M, Zhu, J, Zuo, G.** 2024. The MOSAiC distributed network: Observing the coupled Arctic system with multidisciplinary, coordinated platforms. *Elementa: Science of the Anthropocene* **12**(1): 00103. DOI: <http://dx.doi.org/10.1525/elementa.2023.00103>.
- Rabe, B, Heuzé, C, Regnery, J, Aksenov, Y, Allerholt, J, Athanase, M, Bai, Y, Basque, C, Bauch, D, Baumann, TM, Chen, D, Cole, ST, Craw, L, Davies, A, Damm, E, Dethloff, K, Divine, DV, Doglioni, F, Ebert, F, Fang, Y-C, Fer, I, Fong, AA, Gradinger, R, Granskog, MA, Graupner, R, Haas, C, He, H, He, Y, Hoppmann, M, Janout, M, Kadko, D, Kanzow, T, Karam, S, Kawaguchi, Y, Koenig, Z, Kong, B, Krishfield, RA, Krumpfen, T, Kuhlmeier, D, Kuznetsov, I, Lan, M, Laukert, G, Lei, R, Li, T, Torres-Valdès, S, Lin, L, Lin, L, Liu, H, Liu, N, Loose, B, Ma, X, McKay, R, Mallet, M, Mallett, RDC, Maslowski, W, Mertens, C, Mohrholz, V, Muilwijk, M, Nicolaus, M, O'Brien, JK, Perovich, D, Ren, J, Rex, M, Ribeiro, N, Rinke, A, Schaffer, J, Schuffenhauer, I, Schulz, K, Shupe, MD, Shaw, W, Sokolov, V, Sommerfeld, A, Spreen, G, Stanton, T, Stephens, M, Su, J, Sukhikh, N, Sundfjord, A, Thomisch, K, Tippenhauer, S, Toole, JM, Vredenburg, M, Walter, M, Wang, H, Wang, L, Wang, Y, Wendisch, M, Zhao, J, Zhou, M, Zhu, J.** 2022. Overview of the MOSAiC expedition: Physical oceanography. *Elementa: Science of the Anthropocene* **10**(1): 00062. DOI: <http://dx.doi.org/10.1525/elementa.2021.00062>.
- Randelhoff, A, Holding, J, Janout, M, Sejr, MK, Babin, M, Tremblay, J-É, Alkire, MB.** 2020. Pan-Arctic Ocean primary production constrained by turbulent nitrate fluxes. *Frontiers in Marine Science* **7**. DOI: <http://dx.doi.org/10.3389/fmars.2020.00150>.
- Rantanen, M, Karpechko, AY, Lipponen, A, Nordling, K, Hyvärinen, O, Ruosteenoja, K, Vihma, T, Laaksonen, A.** 2022. The Arctic has warmed nearly four times faster than the globe since 1979. *Communications Earth & Environment* **3**(1): 168. DOI: <http://dx.doi.org/10.1038/s43247-022-00498-3>.
- Rees, AP, Bange, HW, Arévalo-Martínez, DL, Artioli, Y, Ashby, DM, Brown, I, Campen, HI, Clark, DR, Kitidis, V, Lessin, G, Tarran, GA, Turley, C.** 2022. Nitrous oxide and methane in a changing Arctic Ocean. *Ambio* **51**(2): 398–410.
- Rex, M.** 2020. Links to master tracks in different resolutions of POLARSTERN cruise PS122/1, Tromsø–Arctic Ocean, 2019-09-20–2019-12-13 (Version 2). PANGAEA. DOI: <http://dx.doi.org/10.1594/PANGAEA.924668>.
- Rex, M.** 2021a. Master tracks in different resolutions of POLARSTERN cruise PS122/4, Longyearbyen–Arctic Ocean, 2020-06-04–2020-08-12. PANGAEA. DOI: <http://dx.doi.org/10.1594/PANGAEA.926829>.
- Rex, M.** 2021b. Master tracks in different resolutions of POLARSTERN cruise PS122/5, Arctic Ocean–Bremerhaven, 2020-08-12–2020-10-12. PANGAEA. DOI: <http://dx.doi.org/10.1594/PANGAEA.926910>.
- Rijkenberg, MJA, Slagter, HA, van der Loeff, RM, van Ooijen, J, Gerringa, LJA.** 2018. Dissolved Fe in the deep and upper Arctic Ocean with a focus on Fe limitation in the Nansen Basin. *Frontiers in Marine Science* **5**. DOI: <http://dx.doi.org/10.3389/fmars.2018.00088>.
- Rinke, A, Cassano, JJ, Cassano, EN, Jaiser, R, Handorf, D.** 2021. Meteorological conditions during the MOSAiC expedition: Normal or anomalous? *Elementa: Science of the Anthropocene* **9**(1): 00023. DOI: <http://dx.doi.org/10.1525/elementa.2021.00023>.
- Royo-Llonch, M, Sánchez, P, Ruiz-González, C, Salazar, G, Pedrós-Alió, C, Sebastián, M, Labadie, K, Paoli, L, Ibarbalz, FM, Zinger, L, Churchward, B; Tara Oceans Coordinators; Chaffron, S, Eveillard, D, Karsenti, E, Sunagawa, S, Wincker, P, Karp-Boss, L, Bowler, C, Acinas, SG.** 2021. Compendium of 530 metagenome-assembled bacterial and archaeal genomes from the polar Arctic Ocean. *Nature Microbiology* **6**(12): 1561–1574. DOI: <http://dx.doi.org/10.1038/s41564-021-00979-9>.
- Rudels, B, Carmack, E.** 2022. Arctic ocean water mass structure and circulation. *Oceanography* **35**(3–4): 52–65.

- Rybakova, E, Kremenetskaia, A, Vedenin, A, Boetius, A, Gebruk, A. 2019. Deep-sea megabenthos communities of the Eurasian central Arctic are influenced by ice-cover and sea-ice algal falls. *PLoS One* **14**(7): e0211009.
- Rysgaard, S, Glud, RN, Lennert, K, Cooper, M, Halden, N, Leahey, RJG, Hawthorne, FC, Barber, D. 2012. Ikaite crystals in melting sea ice—Implications for pCO<sub>2</sub> and pH levels in Arctic surface waters. *The Cryosphere* **6**(4): 901–908.
- Rysgaard, S, Glud, RN, Sejr, MK, Bendtsen, J, Christensen, PB. 2007. Inorganic carbon transport during sea ice growth and decay: A carbon pump in polar seas. *Journal of Geophysical Research: Oceans* **112**(C3).
- Salganik, E, Katlein, C, Lange, BA, Matero, I, Lei, R, Fong, AA, Fons, SW, Divine, D, Oggier, M, Castellani, G, Bozzato, D, Chamberlain, EJ, Hoppe, CJM, Müller, O, Gardner, J, Rinke, A, Pereira, PS, Ulfso, A, Marsay, C, Webster, MA, Maus, S, Høyland, KV, Granskog, MA. 2023. Temporal evolution of under-ice meltwater layers and false bottoms and their impact on summer Arctic Sea ice mass balance. *Elementa: Science of the Anthropocene* **11**(1): 00035. DOI: <http://dx.doi.org/10.1525/elementa.2022.00035>.
- Sauve, AMC, Taylor, RA, Barraquand, F. 2020. The effect of seasonal strength and abruptness on predator–prey dynamics. *Journal of Theoretical Biology* **491**: 110175.
- Schmid, MS, Aubry, C, Grigor, J, Fortier, L. 2016. The LOKI underwater imaging system and an automatic identification model for the detection of zooplankton taxa in the Arctic Ocean. *Methods in Oceanography* **15–16**: 129–160.
- Schmidt, K, Graeve, M, Hoppe, CJM, Torres-Valdes, S, Welteke, N, Whitmore, LM, Anhaus, P, Atkinson, A, Belt, ST, Brenneis, T, Campbell, RG, Castellani, G, Copeman, LA, Flores, H, Fong, AA, Hildebrandt, N, Kohlbach, D, Nielsen, JM, Parrish, CC, Rad-Menéndez, C, Rokitta, SD, Tippenhauer, S, Zhuang, Y. 2024. Essential omega-3 fatty acids are depleted in sea ice and pelagic algae of the central Arctic Ocean. *Global Change Biology* **30**(1): e17090. DOI: <http://dx.doi.org/10.1111/gcb.17090>.
- Schulz, J, Barz, K, Ayon, P, Luedtke, A, Zielinski, O, Menedoht, D, Hirche, H-J. 2010. Imaging of plankton specimens with the lightframe on-sight keystone species investigation (LOKI) system. *Journal of the European Optical Society-Rapid Publications* **5**: 10017S. DOI: <http://dx.doi.org/10.2971/jeos.2010.10017s>.
- Schulz, J, Möller, KO, Bracher, A, Hieronymi, M, Cisewski, B, Zielinski, O, Voss, D, Gutzeit, E, Dolereit, T, Niedzwiedz, G, Kohlberg, G, Schories, D, Kiko, R, Körtzinger, A, Falldorf, C, Fischer, P, Nowald, N, Beisiegel, K, Martinez-Arbizu, P, Rüssmeier, N, Röttgers, R, Büdenbender, J, Jordt-Sedlazeck, A, Koch, R, Riebesell, U, Iversen, HM, Köser, K, Kwasnitschka, T, Wellhausen, J, Thoma, C, Barz, K, Rhode, S, Nattkemper, TW, Schoening, T, Peeters, F, Hofmann, H, Busch, JA, Hirche, H-J, Niehoff, B, Hildebrandt, N, Stohr, E, Winter, C, Herbst, G, Konrad, C, Schmidt, M, Linke, P, Brey, T, Bange, HW, Nolle, L, Krägefsky, S, Gröger, J, Sauter, E, Schulz, M, Müller, J, Rehder, G, Stepputtis, D, Beszteri, B, Kloster, M, Kauer, G, Göritz, A, Gege, P, von Lukas, UF, Bathmann, UV. 2015. Aquatische optische Technologien in Deutschland. *Meereswissenschaftliche Berichte—Marine Science Reports* **97**: 1–83.
- Schulz, K, Koenig, Z, Muilwijk, M. 2023. The Eurasian Arctic Ocean along the MOSAiC drift (2019–2020): Core hydrographic parameters. Arctic Data Center. DOI: <http://dx.doi.org/10.18739/A21J9790B>.
- Schulz, K, Koenig, Z, Muilwijk, M, Bauch, D, Hoppe, CJM, Droste, E, Hoppmann, M, Chamberlain, EJ, Laukert, G, Stanton, T, Quintanilla-Zurita, A, Fer, I, Heuzé, C, Karam, S, Mieruch-Schnuelle, S, Baumann, TM, Vredenburg, M, Tippenhauer, S, Granskog, MA. 2024. The Eurasian Arctic Ocean along the MOSAiC drift in (2019–2020): An interdisciplinary perspective on physical properties and processes. *Elementa: Science of the Anthropocene* **12**(1): 00114.
- Sherr, EB, Sherr, BF, Wheeler, PA, Thompson, K. 2003. Temporal and spatial variation in stocks of autotrophic and heterotrophic microbes in the upper water column of the central Arctic Ocean. *Deep Sea Research Part I: Oceanographic Research Papers* **50**(5): 557–571. DOI: [http://dx.doi.org/10.1016/S0967-0637\(03\)00031-1](http://dx.doi.org/10.1016/S0967-0637(03)00031-1).
- Shupe, MD, Rex, M, Blomquist, B, Persson, POG, Schmale, J, Uttal, T, Althausen, D, Angot, H, Archer, S, Bariteau, L, Beck, I, Bilberry, J, Bucci, S, Buck, C, Boyer, M, Brasseur, Z, Brooks, IM, Calmer, R, Cassano, J, Castro, V, Chu, D, Costa, D, Cox, CJ, Creamean, J, Crewell, S, Dahlke, S, Damm, E, de Boer, G, Deckelmann, H, Dethloff, K, Dütsch, M, Ebell, K, Ehrlich, A, Ellis, J, Engelmann, R, Fong, AA, Frey, MM, Gallagher, MR, Ganzeveld, L, Gradinger, R, Graeser, J, Greenamyre, V, Griesche, H, Griffiths, S, Hamilton, J, Heinemann, G, Helmig, D, Herber, A, Heuzé, C, Hofer, J, Houchens, T, Howard, D, Inoue, J, Jacobi, H-W, Jaiser, R, Jokinen, T, Jourdan, O, Jozef, G, King, W, Kirchgassner, A, Klingebiel, M, Krassovski, M, Krumpfen, T, Lampert, A, Landing, W, Laurila, T, Lawrence, D, Lonardi, M, Loose, B, Lüpkes, C, Maahn, M, Macke, A, Maslowski, W, Marsay, C, Maturilli, M, Mech, M, Morris, S, Moser, M, Nicolaus, M, Ortega, P, Osborn, J, Pätzold, F, Perovich, DK, Petäjä, T, Pilz, C, Pirazzini, R, Posman, K, Powers, H, Pratt, KA, Preußner, A, Quéléver, L, Radenz, M, Rabe, B, Rinke, A, Sachs, T, Schulz, A, Siebert, H, Silva, T, Solomon, A, Sommerfeld, A, Spreen, G, Stephens, M, Stohl, A, Svensson, G, Uin, J, Viegas, J, Voigt, C, von der Gathen, P, Wehner, B, Welker, JM, Wendisch, M, Werner, M, Xie, ZQ, Yue, F.



2022. Overview of the MOSAiC expedition: Atmosphere. *Elementa: Science of the Anthropocene* **10**(1): 00060. DOI: <http://dx.doi.org/10.1525/elementa.2021.00060>.
- Shupe, MD, Rex, M, Dethloff, K, Damm, E, Fong, AA, Gradinger, R, Heuzé, C, Loose, B, Makarov, A, Maslowski, W, Nicolaus, M, Perovich, D, Rabe, B, Rinke, A, Sokolov, V, Sommerfeld, A.** 2020. Arctic report card 2020: The MOSAiC expedition: A year drifting with the Arctic Sea ice. United States. National Oceanic and Atmospheric Administration. Office of Oceanic and Atmospheric Research. Physical Sciences Laboratory (U.S.); Cooperative Institute for Research in the Atmosphere (Fort Collins, CO). DOI: <http://dx.doi.org/10.25923/9g3v-xh92>.
- Slagstad, D, Ellingsen, IH, Wassmann, P.** 2011. Evaluating primary and secondary production in an Arctic Ocean void of summer sea ice: An experimental simulation approach. *Progress in Oceanography* **90**(1–4): 117–131. DOI: <http://dx.doi.org/10.1016/j.pocean.2011.02.009>.
- Smith, MM, Angot, H, Chamberlain, EJ, Droste, ES, Karam, S, Muilwijk, M, Webb, AL, Archer, SD, Beck, I, Blomquist, BW, Bowman, J, Boyer, M, Bozzato, D, Chierici, M, Creamean, J, D'Angelo, A, Delille, B, Fer, I, Fong, AA, Fransson, A, Fuchs, N, Gardner, J, Granskog, MA, Hoppe, CJM, Hoppema, M, Hoppmann, M, Mock, T, Muller, S, Müller, O, Nicolaus, M, Nomura, D, Petäjä, T, Salganik, E, Schmale, J, Schmidt, K, Schulz, K, Shupe, MD, Stefels, J, Thielke, L, Tippenhauer, S, Ulfso, A, van Leeuwe, M, Webster, M, Yoshimura, M, Zhan, L.** 2023. Thin and transient meltwater layers and false bottoms in the Arctic Sea ice pack—Recent insights on these historically overlooked features. *Elementa: Science of the Anthropocene* **11**(1): 00025. DOI: <http://dx.doi.org/10.1525/elementa.2023.00025>.
- Smith, MM, von Albedyll, L, Raphael, IA, Lange, BA, Matero, I, Salganik, E, Webster, MA, Granskog, MA, Fong, A, Lei, R, Bonnie, L.** 2022. Quantifying false bottoms and under-ice meltwater layers beneath Arctic summer sea ice with fine-scale observations. *Elementa: Science of the Anthropocene* **10**(1): 000116.
- Snoeijs-Leijonmalm, P, Flores, F, Sakinan, S, Hildebrandt, N, Svenson, A, Castellani, G, Vane, K, Mark, FC, Heuzé, C, Tippenhauer, S, Niehoff, B, Hjelm, J, Sundberg, JH, Schaafsma, FL, Engelmann, R; the EFICA-MOSAiC Team.** 2022. Unexpected fish and squid in the central Arctic deep scattering layer. *Science Advances* **8**(7): eabj7536. DOI: <http://dx.doi.org/10.1126/sciadv.abj7536>.
- Søreide, JE, Leu, E, Berge, J, Graeve, M, Falk-Petersen, S.** 2010. Timing of blooms, algal food quality and *Calanus glacialis* reproduction and growth in a changing Arctic. *Global Change Biology* **16**(11): 3154–3163. DOI: <http://dx.doi.org/10.1111/j.1365-2486.2010.02175.x>.
- Steiner, NS, Bowman, J, Campbell, K, Chierici, M, Eronen-Rasimus, E, Falardeau, M, Flores, H, Fransson, A, Herr, H, Insley, SJ, Kauko, HM, Lannuzel, D, Loseto, L, Lynnes, A, Majewski, A, Meiners, KM, Miller, LA, Michel, LN, Moreau, S, Nacke, M, Nomura, D, Tedesco, L, van Franeker, JA, van Leeuwe, MA, Wongpan, P.** 2021. Climate change impacts on sea-ice ecosystems and associated ecosystem services. *Elementa: Science of the Anthropocene* **9**(1): 00007. DOI: <http://dx.doi.org/10.1525/elementa.2021.00007>.
- Stemmann, L, Youngbluth, M, Robert, K, Hosia, A, Picheral, M, Paterson, HL, Ibanez, F, Guidi, L, Lombard, F, Gorsky, G.** 2008. Global zoogeography of fragile macrozooplankton in the upper 100–1000 m inferred from the underwater video profiler. *ICES Journal of Marine Science* **65**(3): 433–442.
- Succurro, A, Ebenhö, O.** 2018. Review and perspective on mathematical modeling of microbial ecosystems. *Biochemical Society Transactions* **46**(2): 403–412.
- Syvrtsen, EE.** 1991. Ice algae in the Barents Sea: Types of assemblages, origin, fate and role in the ice-edge phytoplankton bloom. *Polar Research* **10**(1): 277–288.
- Taskjelle, T, Granskog, MA, Pavlov, AK, Hudson, SR, Hamre, B.** 2017. Effects of an Arctic under-ice bloom on solar radiant heating of the water column. *Journal of Geophysical Research: Oceans* **122**(1): 126–138. DOI: <http://dx.doi.org/10.1002/2016JC012187>.
- Tedesco, L, Vichi, M, Scoccimarro, E.** 2019. Sea-ice algal phenology in a warmer Arctic. *Science Advances* **5**(5): eaav4830. DOI: <http://dx.doi.org/10.1126/sciadv.aav4830>.
- Thiele, S, Storesund, JE, Fernández-Méndez, M, Assmy, P, Øvreås, L.** 2022. A winter-to-summer transition of bacterial and archaeal communities in Arctic Sea ice. *Microorganisms* **10**(8). DOI: <http://dx.doi.org/10.3390/microorganisms10081618>.
- Timmermans, M-L, Marshall, J.** 2020. Understanding Arctic Ocean circulation: A review of ocean dynamics in a changing climate. *Journal of Geophysical Research: Oceans* **125**(4): e2018JC014378. DOI: <http://dx.doi.org/10.1029/2018JC014378>.
- Tippenhauer, S, Vredenburg, M, Heuzé, C, Ulfso, A, Rabe, B, Granskog, MA, Allerholt, J, Balmonte, JP, Campbell, RG, Castellani, G, Chamberlain, E, Creamean, J, D'Angelo, A, Dietrich, U, Droste, ES, Eggers, L, Fang, Y-C, Fong, AA, Gardner, J, Graupner, R, Grosse, J, He, H, Hildebrandt, N, Hoppe, CJM, Hoppmann, M, Kanzow, T, Karam, S, Koenig, Z, Kong, B, Kuhlmeier, D, Kuznetsov, I, Lan, M, Liu, H, Mallet, M, Mohrholz, V, Muilwijk, M, Müller, O, Olsen, LM, Rember, R, Ren, J, Sakinan, S, Schaffer, J, Schmidt, K, Schuffenhauer, I, Schulz, K, Shoemaker, K, Spahic, S, Sukhikh, N, Svenson, A, Torres-Valdés, S, Torstensson, A, Wischnewski, L, Zhuang, Y.** 2023a. Physical oceanography water bottle samples based on ship CTD during POLARSTERN cruise PS122 [dataset]. PANGAEA. DOI: <http://dx.doi.org/10.1594/PANGAEA.959965>.

- Tippenhauer, S, Vredenburg, M, Heuzé, C, Ulfsbo, A, Rabe, B, Granskog, MA, Allerholt, J, Balmonte, JP, Campbell, RG, Castellani, G, Chamberlain, E, Creamean, J, D'Angelo, A, Dietrich, U, Droste, ES, Eggers, L, Fang, Y-C, Fong, AA, Gardner, J, Graupner, R, Grosse, J, He, H, Hildebrandt, N, Hoppe, CJM, Hoppmann, M, Kanzow, T, Karam, S, Koenig, Z, Kong, B, Kuhlmeier, D, Kuznetsov, I, Lan, M, Liu, H, Mallet, M, Mohrholz, V, Muilwijk, M, Müller, O, Olsen, LM, Rember, R, Ren, J, Sakinan, S, Schaffer, J, Schmidt, K, Schuffenhauer, I, Schulz, K, Shoemaker, K, Spahic, S, Sukhikh, N, Svenson, A, Torres-Valdés, S, Torstensson, A, Wischnewski, L, Zhuang, Y.** 2023b. Physical oceanography water bottle samples based on ocean city CTD during POLARSTERN cruise PS122 [dataset]. PANGAEA. DOI: <http://dx.doi.org/10.1594/PANGAEA.959966>.
- Torres-Valdés, S, Rember, R, Heitmann, L, Ludwischowski, K-U, Ulfsbo, A, Fong, AA, Hoppe, CJM, Kuznetsov, I, Damm, E, Graeve, M, Dietrich, U, Chamberlain, E, Droste, ES, Creamean, J, Gardner, J, Müller, O, Balmonte, JP, Rost, B.** 2024a. Dissolved nutrients data from the PS122 MOSAiC expedition carried out onboard Polarstern during Legs 1 to 3 [dataset]. PANGAEA. DOI: <http://dx.doi.org/10.1594/PANGAEA.966213>.
- Torres-Valdés, S, Rember, R, Heitmann, L, Ludwischowski, K-U, Ulfsbo, A, Fong, AA, Hoppe, CJM, Kuznetsov, I, Damm, E, Graeve, M, Dietrich, U, Chamberlain, E, Droste, ES, Creamean, J, Gardner, J, Müller, O, Balmonte, JP, Rost, B.** 2024b. Dissolved nutrients data from the PS122 MOSAiC expedition carried out at the AWI nutrient facility [dataset]. PANGAEA. DOI: <http://dx.doi.org/10.1594/PANGAEA.966217>.
- Torstensson, A, Margolin, AR, Showalter, GM, Smith WO Jr, Shadwick, EH, Carpenter, SD, Bolinesi, F, Deming, JW.** 2021. Sea-ice microbial communities in the Central Arctic Ocean: Limited responses to short-term pCO<sub>2</sub> perturbations. *Limnology and Oceanography* **66**(S1): S383–S400. DOI: <http://dx.doi.org/10.1002/lno.11690>.
- Tortell, PD.** 2005. Dissolved gas measurements in oceanic waters made by membrane inlet mass spectrometry. *Limnology and Oceanography: Methods* **3**: 24–37.
- Tremblay, J-É, Anderson, LG, Matrai, P, Coupel, P, Bélanger, S, Michel, C, Reigstad, M.** 2015. Global and regional drivers of nutrient supply, primary production and CO<sub>2</sub> drawdown in the changing Arctic Ocean. *Progress in Oceanography* **139**: 171–196. DOI: <http://dx.doi.org/10.1016/j.pocean.2015.08.009>.
- Ulfsbo, A, Cassar, N, Korhonen, M, van Heuven, S, Hoppema, M, Kattner, G, Anderson, LG.** 2014. Late summer net community production in the central Arctic Ocean using multiple approaches. *Global Biogeochemical Cycles* **28**(10): 1129–1148. DOI: <http://dx.doi.org/10.1002/2014gb004833>.
- Vandermeer, J.** 1996. Seasonal isochronic forcing of Lotka Volterra equations. *Progress of Theoretical Physics* **96**(1): 13–28.
- Vernet, M, Ellingsen, IH, Seuthe, L, Slagstad, D, Cape, MR, Matrai, PA.** 2019. Influence of phytoplankton advection on the productivity along the Atlantic water inflow to the Arctic Ocean. *Frontiers in Marine Science* **6**. DOI: <http://dx.doi.org/10.3389/fmars.2019.00583>.
- Volterra, V.** 1927. *Variazioni e Fluttuazioni Del Numero d'individui in Specie Animali Conviventi* (vol. 2). di Castello, Italy: Società Anonima Tipografica “Leonardo da Vinci”: 31–113.
- von Albedyll, L, Hendricks, S, Hutter, N, Murashkin, D, Kaleschke, L, Willmes, S, Thielke, L, Tian-Kunze, X, Spreen, G, Haas, C.** 2024. Lead fractions from SAR-derived sea ice divergence during MOSAiC. *The Cryosphere* **18**(3): 1259–1285. DOI: <http://dx.doi.org/10.5194/tc-2023-123>.
- von Appen, W-J, Waite, AM, Bergmann, M, Bienhold, C, Boebel, O, Bracher, A, Cisewski, B, Hagemann, J, Hoppema, M, Iversen, MH, Konrad, C, Krumpfen, T, Lochthofen, N, Metfies, K, Niehoff, B, Nöthig, E-M, Purser, A, Salter, I, Schaber, M, Scholz, D, Soltwedel, T, Torres-Valdes, S, Wekerle, C, Wenzhöfer, F, Wietz, M, Boetius, A.** 2021. Sea-ice derived meltwater stratification slows the biological carbon pump: Results from continuous observations. *Nature Communications* **12**(1): 7309.
- Wadhams, P, Toberg, N.** 2012. Changing characteristics of Arctic pressure ridges. *Polar Science* **6**(1): 71–77.
- Wang, SW, Budge, SM, Iken, K, Gradinger, RR, Springer, AM, Wooller, MJ.** 2015. Importance of sympagic production to Bering Sea zooplankton as revealed from fatty acid-carbon stable isotope analyses. *Marine Ecology Progress Series* **518**: 31–50.
- Wassmann, P, Carmack, EC, Bluhm, BA, Duarte, CM, Berge, J, Brown, K, Grebmeier, JM, Holding, J, Kosobokova, K, Kwok, R, Matrai, P, Agusti, S, Babin, M, Bhatt, U, Eicken, H, Polyakov, I, Rysgaard, S, Huntington, HP.** 2020. Towards a unifying Pan-Arctic perspective: A conceptual modelling toolkit. *Progress in Oceanography* **189**: 102455. DOI: <http://dx.doi.org/10.1016/j.pocean.2020.102455>.
- Wassmann, P, Reigstad, M.** 2011. Future Arctic Ocean seasonal ice zones and implications for pelagic-benthic coupling. *Oceanography* **24**(3): 220–231. DOI: <http://dx.doi.org/10.5670/oceanog.2011.74>.
- Wiedmann, I, Ceballos-Romero, E, Villa-Alfageme, M, Renner, AHH, Dybwad, C, van der Jagt, H, Svensen, C, Assmy, P, Wiktor, JM, Tatarek, A, Róžańska-Pluta, M, Iversen, MH.** 2020. Arctic observations identify phytoplankton community composition as driver of carbon flux attenuation. *Geophysical Research Letters* **47**(14): e2020GL087465. DOI: <http://dx.doi.org/10.1029/2020GL087465>.
- Wietz, M, Bienhold, C, Metfies, K, Torres-Valdés, S, von Appen, W-J, Salter, I, Boetius, A.** 2021. The polar night shift: Seasonal dynamics and drivers of Arctic Ocean microbiomes revealed by autonomous

- sampling. *ISME Communications* **1**(1): 76. DOI: <http://dx.doi.org/10.1038/s43705-021-00074-4>.
- Woods, JD.** 1985. The world ocean circulation experiment. *Nature* **314**(6011): 501–511. DOI: <http://dx.doi.org/10.1038/314501a0>.
- Yue, F, Angot, H, Blomquist, B, Schmale, J, Hoppe, CJM, Lei, R, Shupe, MD, Zhan, L, Ren, J, Liu, H, Beck, I, Howard, D, Jokinen, T, Laurila, T, Quéléver, L, Boyer, M, Petäjä, T, Archer, S, Bariteau, L, Helmig, D, Hueber, J, Jacobi, H-W, Posman, K, Xie, Z.** 2023. The marginal ice zone as a dominant source region of atmospheric mercury during central Arctic summertime. *Nature Communications* **14**(1): 4887.
- Zeebe, RE, Eicken, H, Robinson, DH, Wolf-Gladrow, D, Dieckmann, GS.** 1996. Modeling the heating and melting of sea ice through light absorption by microalgae. *Journal of Geophysical Research: Oceans* **101**(C1): 1163–1181.
- Zhang, J, Spitz, YH, Steele, M, Ashjian, C, Campbell, R, Berline, L, Matrai, P.** 2010. Modeling the impact of declining sea ice on the Arctic marine planktonic ecosystem. *Journal of Geophysical Research: Oceans* **115**(C10). DOI: <http://dx.doi.org/10.1029/2009JC005387>.
- Zhong, Z-P, Vik, D, Rapp, JZ, Zablocki, O, Maughan, H, Temperton, B, Deming, JW, Sullivan, MB.** 2023. Lower viral evolutionary pressure under stable versus fluctuating conditions in subzero Arctic brines. *Microbiome* **11**(1): 174. DOI: <http://dx.doi.org/10.1186/s40168-023-01619-6>.

**How to cite this article:** Fong, AA, Hoppe, CJM, Aberle, N, Ashjian, CJ, Assmy, P, Bai, Y, Bakker, DCE, Balmonte, JP, Barry, KR, Bertilsson, S, Boulton, W, Bowman, J, Bozzato, D, Bratbak, G, Buck, M, Campbell, RG, Castellani, G, Chamberlain, EJ, Chen, J, Chierici, M, Cornils, A, Creamean, JM, Damm, E, Dethloff, K, Droste, ES, Ebenhöf, O, Eggers, SL, Engel, A, Flores, H, Fransson, A, Frickenhaus, S, Gardner, J, Gelfman, CE, Granskog, MA, Graeve, M, Havermans, C, Heuzé, C, Hildebrandt, N, Hill, TCJ, Hoppema, M, Immerz, A, Jin, H, Koch, BP, Kong, X, Kraberg, A, Lan, M, Lange, BA, Larsen, A, Lebreton, B, Leu, E, Loose, B, Maslowski, W, Mavis, C, Metfies, K, Mock, T, Müller, O, Nicolaus, M, Niehoff, B, Nomura, D, Nöthig, E-M, Oggier, M, Oldenburg, E, Olsen, LM, Peeken, I, Perovich, DK, Popa, O, Rabe, B, Ren, J, Rex, M, Rinke, A, Rokitta, S, Rost, B, Sakinan, S, Salganik, E, Schaafsma, FL, Schäfer, H, Schmidt, K, Shoemaker, KM, Shupe, MD, Snoeijis-Leijonmalm, P, Stefels, J, Svenson, A, Tao, R, Torres-Valdés, S, Torstensson, A, Toseland, A, Ulfso, A, Van Leeuwe, MA, Vortkamp, M, Webb, AL, Zhuang, Y, Gradinger, RR. 2024. Overview of the MOSAiC expedition: Ecosystem. *Elementa: Science of the Anthropocene* **12**(1). DOI: <https://doi.org/10.1525/elementa.2023.00135>

**Domain Editor-in-Chief:** Jody W. Deming, University of Washington, Seattle, WA, USA

**Knowledge Domain:** Ocean Science

**Part of an Elementa Special Feature:** The Multidisciplinary Drifting Observatory for the Study of Arctic Climate (MOSAIC)

**Published:** August 21, 2024    **Accepted:** June 15, 2024    **Submitted:** December 07, 2023

**Copyright:** © 2024 The Author(s). This is an open-access article distributed under the terms of the Creative Commons Attribution 4.0 International License (CC-BY 4.0), which permits unrestricted use, distribution, and reproduction in any medium, provided the original author and source are credited. See <http://creativecommons.org/licenses/by/4.0/>.

